

About CRM Group

Collaborate with us



Vision & innovation

WITH

Industrial solutions

For a better future

Discover
MaterHYum
Platform

CRM Group
Your expert partner in hydrogen

CRM Group
is an independent research center founded **in 1948**

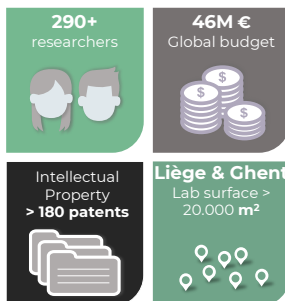

We are active in the fields of **metal, energy transition, advanced manufacturing, digitization, the circular economy, and construction.**

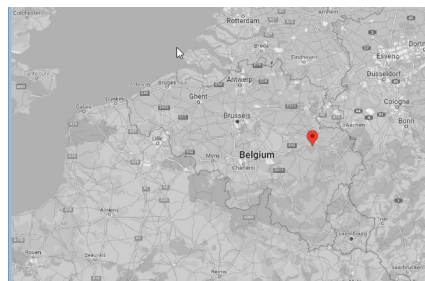

Located within the Liège Science Park – Sart Tilman, our shared facility is equipped with a wide range of testing rigs and capabilities, fluid storage tanks, and purpose-built infrastructure that supports our full spectrum of operations. The site can accommodate over 700 sensors and measurement lines.

Reach out to us if you would like visit our test centre:
Rue Grande Traverse, n°3 –
Bâtiment 17b –
B-4000 Liège Belgium

Want to collaborate with us?

Let's talk about it!

Contact us via

bdservices@crmgroup.be

Jérôme Dagruma :

jerome.dagruma@beblue-cryotech.eu

Maiwenn Larnicol :

maiwenn.larnicol@crmgroup.be

www.crmgroup.be

For a better future



MaterHYum Platform

Experience the power of our operational platform : coming in 2026

Hydrogen expertise in measurement

A new validation / certification service of materials and components under hydrogen in real conditions of use



Gaseous hydrogen and hydrogen blends
Tensile & fatigue testing
Up to 500 bars



Autoclaves for static exposure
Up to 700 bars

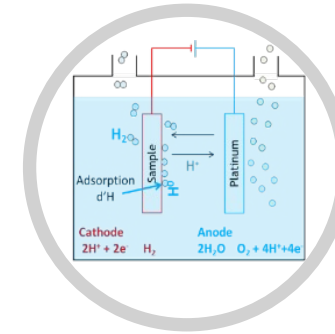

Electrochemical cells



Controlled atmosphere furnace

Demonstrated expertise in deuterium-based processes

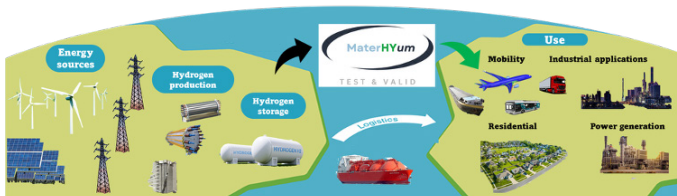

Cryogenic
Tensile & fatigue testing
Cooling system at 20K

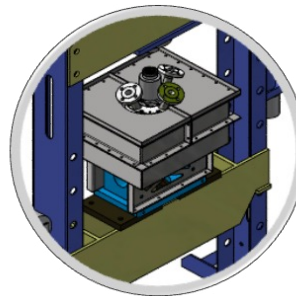
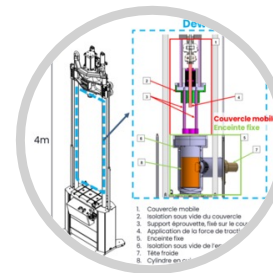

Hydrogen permeation
Up to 1000 bars

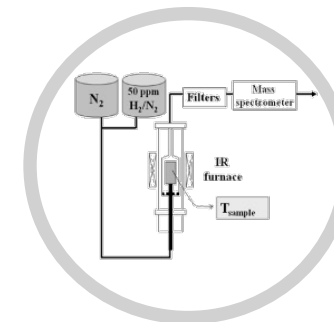

Hydrogen quantification



Constant load testing
Tensile or bending test

Accelerate the market introduction of hydrogen value chain components

