

EN

Welcome! to our world

RM[®]
GROUP

EXTREMELY POWERFUL INCREDIBLY MOBILE

RM SCREENS

RUBBLEMASTER.COM



RM GROUP FACTS



"It all started with a vision: we wanted to make it possible to recycle C&D waste materials on site. This innovative idea became an international success, and we are now the world leader in compact crushing. This folder provides you with an overview of our screens, which make it possible to process C&D waste materials and natural rock on site profitably. Please contact us - we look forward to talking to you!"

Gerald Hanisch
Founder and Managing Director
RUBBLE MASTER HMM GmbH

WELCOME! TO OUR WORLD

The RM Group has two production sites: RM Headquarters in Linz and RM Dungannon, where our screens are manufactured. As an owner-managed company, product quality is the key principle and immutable priority at RUBBLE MASTER. The guiding principle of our sustainability concept is to promote green ideas in green buildings where green products are created.

WORLD MARKET LEADER IN MOBILE CRUSHING AND SCREENING

RM compact machines are crushers and screens with the best weight/size ratio worldwide with the highest throughput capacity in each transport class: versatile, powerful and excellent value retention. Fastest set up time and smallest space requirements are part of the deal! Mobile stockpile belts and digital services round off the RM product range.



HIGHLIGHTS RM HS-SERIES

SCALPERS – COARSE MATERIAL SCREENING EQUIPMENT: The screens in the SCALPER series are durable, robust, high performance machines designed to handle the heaviest applications in the harshest conditions. Whether it's heavy rock or bulky construction and demolition material, thanks to their versatility and high throughput the SCALPER series screens minimise material handling and deliver high quality end products.



FEED HOPPER

Large feed hopper with a heavy duty multiply belt as standard. The speed of the belt feeder is adjustable to ensure smooth material flow onto the screenbox.



WIDE ACCESS ENGINE COMPARTMENT DOORS

Provide perfect access for service and maintenance of engine and hydraulics.



SCREEN DECKS

Multitude of combinations and configurations for top and bottom decks including e.g. punch plate, before screen, finger deck, square and elongated meshes – one scalper for different applications.



MEDIUM AND FINE MATERIAL BELTS

Adjustable speed, as well as over the top folding for optimized transport dimensions.



HIGH POWER SCREENBOX

Features adjustable screenbox angle (except RM HS3500M) with an amplitude of up to 10 mm achieves highly accurate material split with exceptional throughput performance even when screening the most difficult materials.



EASY TO TRANSPORT

Scalper can be moved in one piece without disassembling catwalks.



HARDOX APRON

Optional – robust construction allowing for use in difficult and heavy duty materials.
(only for RM HS7500 & RM HS11000)



THE FULL PACKAGE

RM delivers a top quality package: straightforward set-up, flexibility, high material quality, profitability, simple maintenance, intuitive operation and great design: ideal for on-site action.

Billy Todd, Owner,
108 Excavating, USA

Not every option is available for all machines.

RM HS-SERIES

SCALPER SERIES – COARSE MATERIAL SCREENING EQUIPMENT

	RM HS3500M	RM HS5000M	RM HS7500M	RM HS11000M
SCREENBOX				
SCREEN SURFACE	2.743 x 1.220 mm	3.660 x 1.420 mm	4.880 x 1.525 mm	6.100 x 1.830 mm
ANGLE	14°	15° - 20°	15° - 20°	13° - 17°
FEED HOPPER				
VOLUME (WITH HYD. FOLDABLE BUNKER WALLS)	5 m ³	6 m ³	8.7 m ³	8.7 m ³
BELT WIDTH	1.050 mm	1.300 mm	1.400 mm	1.400 mm
OVERSIZE MATERIAL				
DISCHARGE BELT				
BELT WIDTH	1.050 mm	1.200 mm	1.600 mm	1.600 mm
DISCHARGE HEIGHT	3.430 mm	2.580 - 3.918 mm	2.980 - 3.780 mm	2.700 - 3.900 mm
MID-SIZE				
DISCHARGE BELT				
BELT WIDTH	650 mm	800 mm	900 mm	1.000 mm
DISCHARGE HEIGHT	3.245 mm	3.685 mm	3.780 mm	3.731 mm
FINES DISCHARGE BELT				
BELT WIDTH	650 mm	800 mm	900 mm	1.050 mm
DISCHARGE HEIGHT	3.245 mm	3.885 mm	4.080 mm	3.917 mm
TRANSPORT DIMENSIONS (L X B X H)	9.880 x 2.600 x 3.190 mm	13.450 x 2.800 x 3.300 mm	15.005 x 2.990 x 3.450 mm	16.890 x 3.120 x 3.550 mm
WEIGHT				
BASIC MACHINE	16.500 kg	25.700 kg	30.400 kg Belt 33.400 kg Apron	37.500 kg Belt 40.500 kg Apron



RM HS5000M TURNS EXCAVATED LIMESTONE INTO VALUE AGGREGATE

Excavated material from a large construction site in Hallein is crushed and screened using RM machines and then resold.

Material excavated from an underground car park construction site is first crushed by the RM 120GO!. The limestone is then screened by the RM HS5000M into 0/8, 8/16 and 16/32 fractions. The 8/16 material is sold immediately as filter gravel for a nearby highway renovation project.

WORKING DIMENSIONS

RM HS3500M

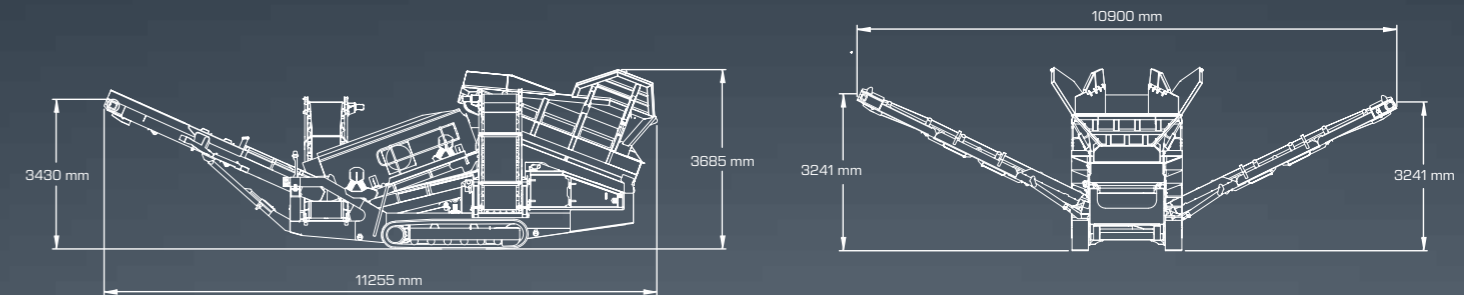

RM HS5000M

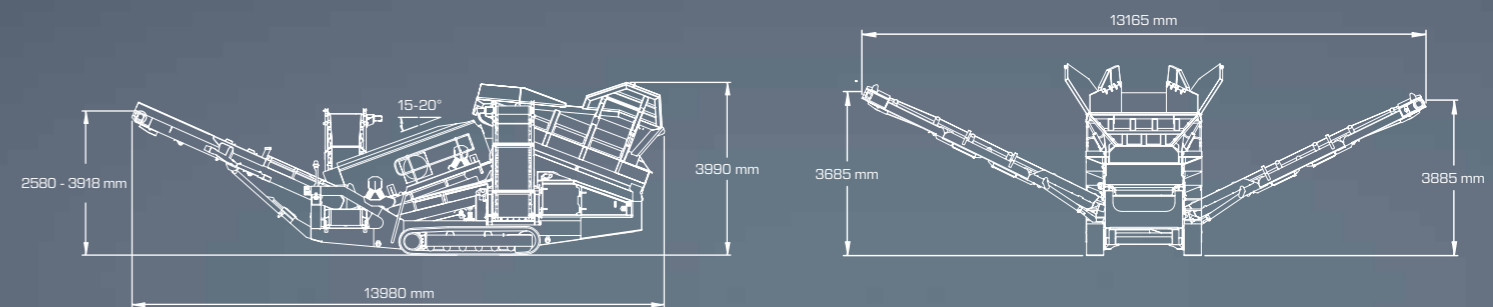

RM HS7500M

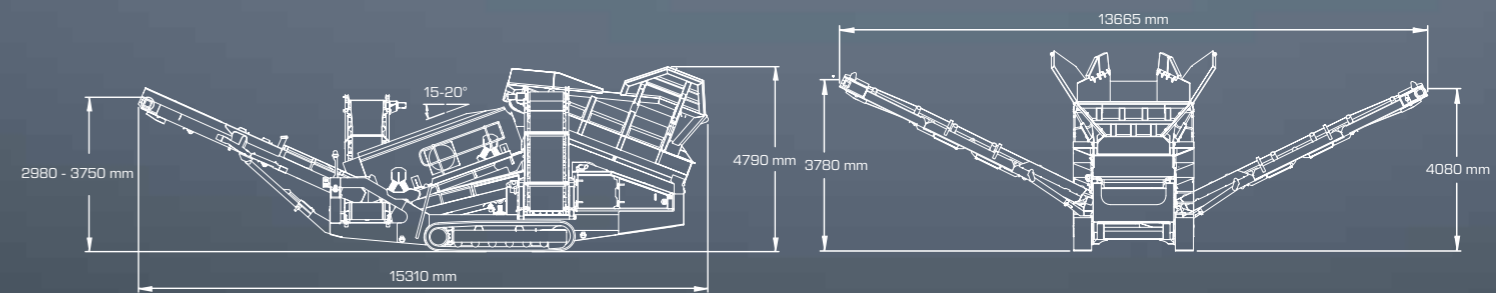

RM HS11000M

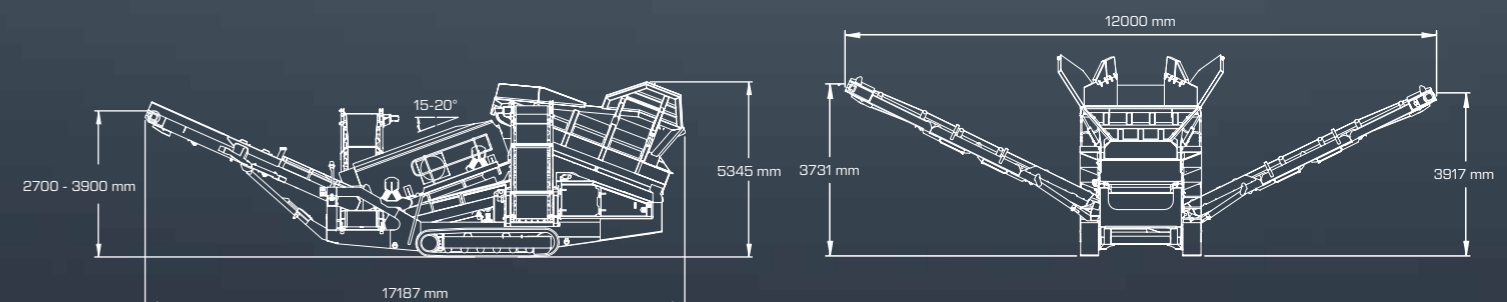

Specifications subject to change in line with technical developments. Machines comply with Guideline 2006/42/EC of the European Parliament.

HIGHLIGHTS RM MSC-SERIES

RM SIZING SCREENS – VIBRATING POST SCREENING EQUIPMENT: RUBBLE MASTER sizing screens have been developed for operators who require high volumes of high grade aggregate material. The unique high power screenbox design is the optimum in screenbox dynamics. With the addition of the 4th product conveyor it can produce up to 4 different grades of materials.

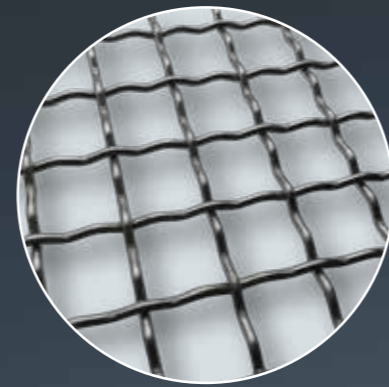

SCREEN DECKS
Multitude of combinations and configurations for top and bottom deck including e.g. square and elongated meshes and harp screens.



QUICK WEDGE TENSIONING
Fast and easy change of screen cloths keep setup times to a minimum.



9.2 M³ HOPPER, WIDE LOADING AREA
Enables the use of wider loading buckets.



WIDE ACCESS ENGINE COMPARTMENT DOORS
Provide perfect access for service and maintenance of engine and hydraulics.



UNIQUE MATERIAL QUALITY

RUBBLE MASTER has changed my business. I am proud of the high quality end product. Large competitors cannot match my material quality.

**Alfred Lauzon, CEO,
Northern Paving, Canada**



RINSER OPTION
Wet screening for increased product quality.



MAIN CONVEYOR
41" main conveyor for high capacity material transfer.



WIDE CHUTES AND DISCHARGE BELTS
Ensures optimum material flow and longer belt life with adjustable belt speeds.

Not every option is available for all machines.

RM MSC-SERIES

SIZING SERIES

VIBRATING SCREENING EQUIPMENT

	RM MSC8500M-2D	RM MSC8500M-3D	RM MSC10500M-2D	RM MSC10500M-3D
SCREENBOX				
SCREEN SURFACE	5.485 x 1.525 mm	5.485 x 1.525 mm	6.700 x 1.525 mm	6.700 x 1.525 mm
ANGLE	20° - 30°	20° - 30°	20° - 30°	20° - 30°
FEED HOPPER				
VOLUME	9,2 m ³	9,2 m ³	9,2 m ³	9,2 m ³
BELT WIDTH	1.050 mm	1.050 mm	1.050 mm	1.050 mm
MAIN CONVEYOR				
BELT WIDTH	1.050 mm	1.050 mm	1.050 mm	1.050 mm
FINES DISCHARGE BELT				
BELT WIDTH	1.200 mm	1.200 mm	1.200 mm	1.200 mm
DISCHARGE HEIGHT	3.750 - 4.960 mm	3.880 - 5.025 mm	4.300 - 5.675 mm	4.700 - 5.725 mm
SIDE DISCHARGE BELT				
BELT WIDTH	800 mm	800 mm	800 mm	800 mm
DISCHARGE HEIGHT	5.100 mm	4.700 mm 4.615 mm	5.100 mm	5.100 mm
TRANSPORT DIMENSIONS (L X B X H)	17.710 x 3.400 x 3.400 mm	17.710 x 3.400 x 3.400 mm	19.000 x 3.400 x 3.550 mm	19.000 x 3.400 x 3.550 mm
WEIGHT				
BASIC MACHINE	32.000 kg	35.000 kg	36.000 kg	37.500 kg
RINSER OPTION INCLUDING SPRAY BARS AND CATCHBOX	—	optional	—	optional



PROCESSING GRANITE WITH RM CRUSHER & SCREEN COMBINATION

In use 12 hours per day with various materials. Impressive all round thanks to high throughput of reinforced concrete and granite, rapid set-up and reliable customer service. Even with extremely abrasive granite with a silicate content of up to 80 %, the RM combination outputs up to 120 t/h. The RM post screen separates the value aggregate into the specified fractions 0-6 and 6-22 mm.

WORKING DIMENSIONS

RM MSC8500M-2D

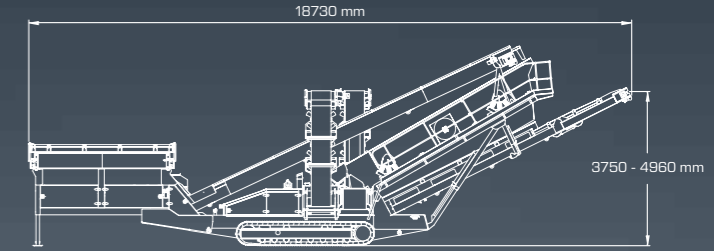
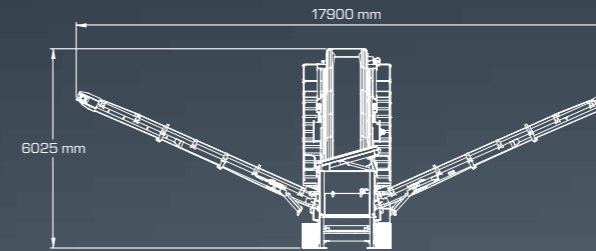

RM MSC8500M-3D

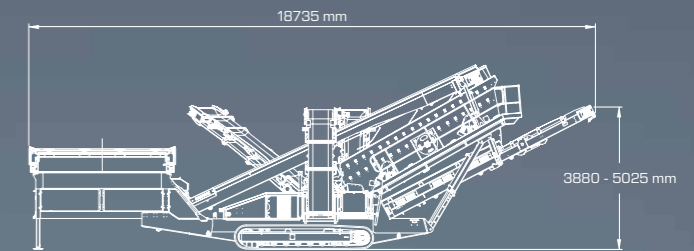
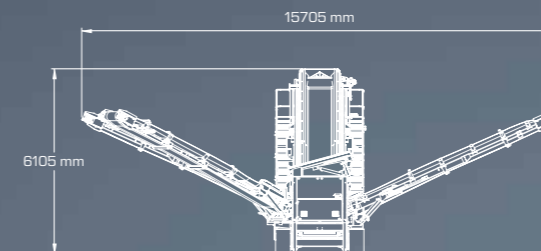

RM MSC10500M-2D

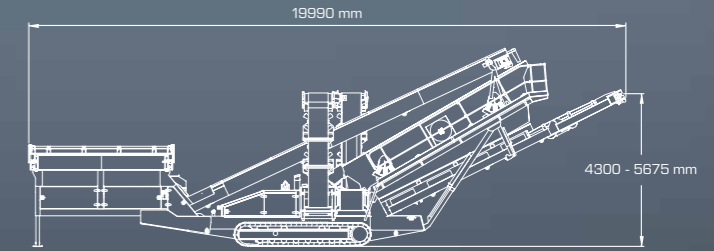
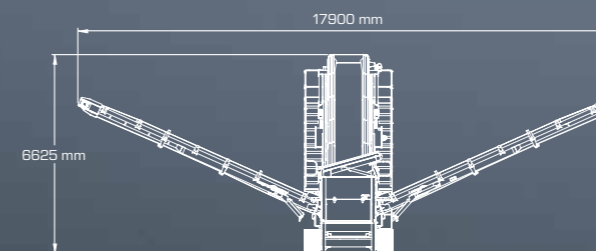

RM MSC10500M-3D

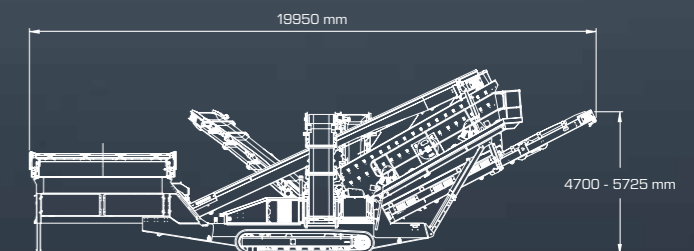
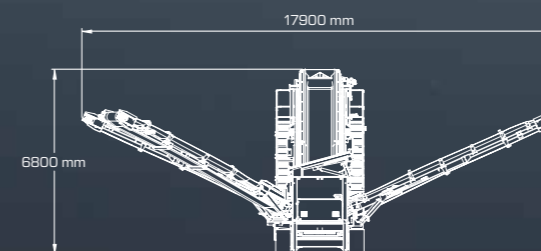

Specifications subject to change in line with technical developments. The machine complies with Guideline 2006/42/EC of the European Parliament.

XTREMELY EFFICIENT, SIMPLE AND SAFE



RM HYBRID DRIVE TECHNOLOGY ENABLES:

- Utilization of most cost-effective, available power source
- Single source crushing & screening:
 - › Up to 25% less fuel consumption
 - › Less maintenance compared to hydraulic machines
 - › Even higher energy savings by supplying the screen from a RM crusher.

RM SMART ASSISTANTS

Stay safe & convenient in the excavator cabinet. Quickly recognize when action is required via:

- RM XSMART Condition Monitoring & Fleet Management
- RM XSMART Mobile App
- RM Communication Lighting

RM GO! PRINCIPLE

- RM GO! operation panel
- Simply choose between diesel- or electric operation
- Operation from the same side as on RM crushers (LHS)
- All-in-one radio remote control
- Auto-start/auto-stop of all conveyors and screen box

TECHNICAL DETAILS

SCREEN BOX, SCREEN SURFACE	5.485 x 1.525 mm 18' x 5' 215.9 ft ² screening surface
SCREEN ANGLE	20° - 30° inclination
FEED HOPPER VOLUME	9,2 m ³
FEED & MAIN CONVEYOR	1.050 mm 42" belt width
FINES CONVEYOR	1.200 mm 48" belt width 3.880 - 5.025 mm 152.7" - 197.9" discharge height
SIDE CONVEYOR	800 mm 31.4" belt width 4.700 - 4.615 5.100 mm 181.1" discharge height
TRANSPORT DIMENSION	L 17.710 W 3.400 H 3.550 mm L 58' W 9' 10" H 11'
WEIGHT	34.500kg 2d or 37.500kg 3d base machine
GRID SPECIFICATION FOR EXTERNAL SUPPLY	400 V 50 Hz 125 A
SUPPLY POWER	65,2 kW
AVERAGE POWER	50 kW



RM MSC8500e

XTREMELY EFFICIENT THANKS TO RM HYBRID DRIVE SYSTEM

30 YEARS OF EXPERIENCE in electrification

Available as 2D, 3D & 3DR



YOUR BENEFITS

- Significant reduction of energy costs
- Environmentally friendly – low CO₂, dust & noise emission operation
- Expanding business opportunities - utilize the flexibility of two drive systems in one compartment space
- Highest Usability by RM GO! Principle
- RM XSMART for performance analysis, service and maintenance
- screen media & options

OPTIONS

- Double deck livehead incl. spillplate (in place of grid)
- RM belt weighing system for all discharge conveyors
- Speed control for midsize conveyors
- Dust suppression spray bars on all discharge conveyors (without pump)
- Dust covers for all discharge conveyors and hopper outlet
- Engine compartment lighting & light beam
- And much more

HIGHLIGHTS RM CS-SERIES

CONTAINER SCREEN – SKID-MOUNTED SCREENING EQUIPMENT: A post screen for every crusher. Each size of screen in the CS series is designed to be perfectly compatible with our mobile crushers. All the screens are powerful and process grain from recycling and natural rock as well as round grain to standardised grain sizes.

Depending on the type of screen and crusher, between one and three fractions can be produced in a single pass. Like all RM products, the post screens in the CS series stand out thanks to their low maintenance requirement and useful features, such as self-cleaning screen decks.



ADVANCED TECHNOLOGY
Excellent screening accuracy even at maximum throughput; highly efficient thanks to self-cleaning screen deck options.



LARGE SCREEN MEDIA RANGE
RM offers a wide selection of different screen decks to optimise the screening process and achieve the right grade aggregate.



COMPACT DESIGN
Compact, lightweight and mobile: the CS series are quickly transported to any job site using a hook-lift truck.



SMALL FOOTPRINT
Enables truly compact set-up areas.



PLUGS IN TO CRUSHER
Enormous energy savings due to screener being powered by crusher.



PORTABLE QUARRY
True versatility to produce high quality aggregates.



FAST SET UP TIMES
CS series screens are quickly transported and ready for action within minutes.



SUITS YOUR NEEDS
Versatile and very efficient for sorting recycling, building materials and natural rock.



COMPACT AND RELIABLE

RM stands for reliable and compact systems featuring innovative technology and high quality materials.

Mauricio Andrade Sanchez, Mexiko,
CEO and Owner, Euro Representaciones S.A. de C.V.

Not every option is available for all machines.

RM CS-SERIES

ELECTRIC HOOK LIFT

MOBILE SCREENS

	RM CS2500 1D/2D	RM CS3600 2D	RM CS4800 2D
SCREEN MESH SIZE	2.500 x 1.000 mm	3.000 x 1.200 mm	3.500 x 1.300 mm
DECK DATA	1 deck (2 deck)	2 deck	2 deck
SCREENBOX, ANGLE	8° - 15°	8° - 15°	8° - 10°
OUTPUT	up to 80 t/h (100 t/h), depending on screen angle, mesh size and feed material	up to 150 t/h, depending on screen angle, mesh size and feed material	up to 250 t/h, depending on screen angle, mesh size and feed material
DRIVE	fully electric; powered by crusher or external grid supply	fully electric; powered by crusher or external grid supply	fully electric; powered by crusher or external grid supply
FEED MATERIAL SIZE	Edge length max. 70 mm	Edge length max. 70 mm	Edge length max. 70 mm
SCREENING RANGE	0/4 to 0/40 mm	0/4 to 0/40 mm	0/4 to 0/40 mm
FINES DISCHARGE BELT			
CONVEYOR LENGTH	9.600 mm	8.760 mm	9.155 mm
DISCHARGE HEIGHT	2.600 - 3.700 mm	2.400 - 3.440 mm	2.340 - 3.260 mm
MID-SIZE- AND OVERSIZE DISCHARGE BELT			
CONVEYOR LENGTH	6.700 mm	6.835 mm	7.500 mm
DISCHARGE HEIGHT	2.300 - 3.300 mm	2.510 - 3.850 mm	2.680 - 3.970 mm
TRANSPORT DIMENSIONS (L X B X H)	7.530 x 2.200 x 2.840 mm	7.640 x 2.480 x 2.270 mm	8.220 x 2.400 x 2.610 mm
TRANSPORT WEIGHT	4 t (4,7 t*)	6,3 t	7 t
OPTIONS	second screen deck with addi- tional conveyor belt for over- sized material (throughput up to 100 t/h, total weight 4.7 t)	—	—



CRUSHER AND SCREEN BLESSED BEFORE STARTING OPERATION IN MANILA

Philippine mining company starts processing limestone with RM. This RM customer is well-known primarily for nickel mining. Now they have expanded their business model with RM to include mobile processing of limestone for cement production. Following training and start-up by the RM service technician and the traditional blessing ritual, the 12 tonne RM 60 plus RM CS2500 screen has been in operation up to eight hours a day.

WORKING DIMENSIONS

RM CS2500

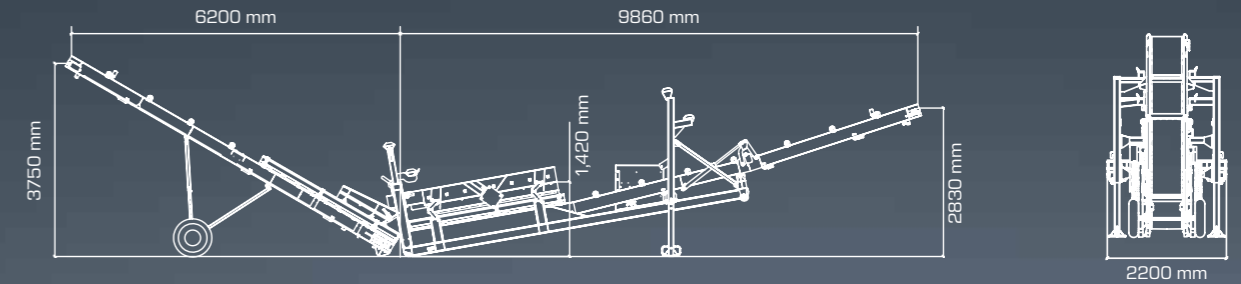

RM CS3600

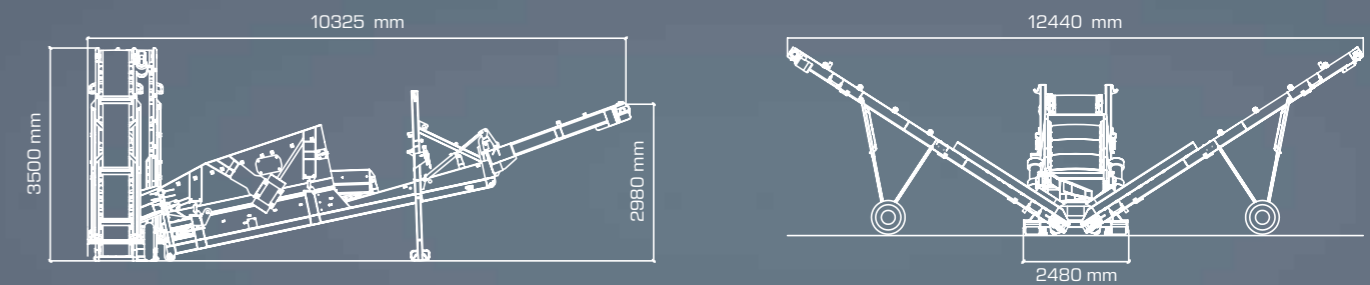

RM CS4800

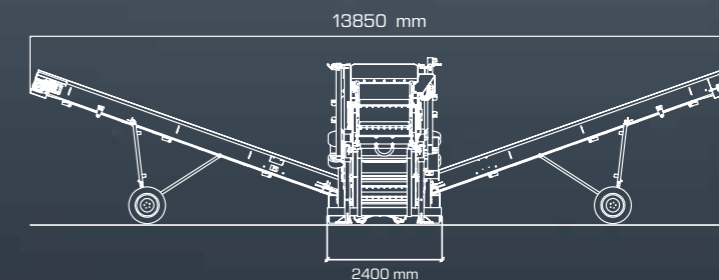
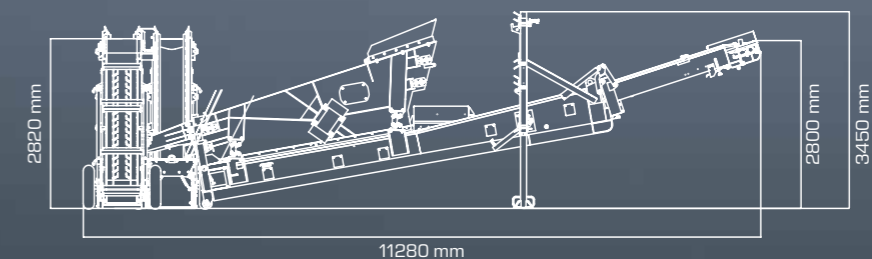

Specifications subject to change in line with technical developments. The machine complies with Guideline 2006/42/EC of the European Parliament.

ALWAYS THE BEST SOLUTION

FROM STAND-ALONE MACHINES TO LARGE MACHINE TRAINS

With its wide range of crushers and screens and their combination options, RM offers an incredible variety of proven solutions for the most diverse ap-

plications and customer requirements. Perfectly matched machines ensure maximum efficiency, as do state-of-the-art electric and hybrid drive systems. Whether you are entering the crushing and screening business with a single machine, or you are one of the more

experienced operators, RM has got you covered for the future. We support your growth and new business opportunities with different sizes, a modular machine concept, and state-of-the-art digital systems that make your daily work easier and even more profitable.



WIDE RANGE OF COMBINATION OPTIONS

CHOOSE THE PERFECT SOLUTION

RM's extensive product range of crushers and screens enables an enormous variety of combination options optimally matched to your application.

MODULAR AND SCALABLE - TAILORED TO YOUR APPLICATION

The different sizes of crushers and screens allow you to configure the ideal machine train combination depending on your throughput and material requirements.

FLEXIBLE EXPANDABILITY - READY TO ACCOMPANY YOUR GROWTH

Whether you want to expand your business or application with additional machines, or your growth requires larger

equipment, the modularity of RM machines allows you to appropriately expand or enlarge your production line at any time.

SAVE FUEL AND REDUCE YOUR CARBON FOOTPRINT

Thanks to the extensive range of RM machines with hybrid drive and electric drive solutions, you not only save up to 25% fuel costs in stand-alone operation, but can save up to 33% energy costs if, for example, a screen is electrically powered by the crusher.

Combining hybrid plants together results in even higher savings of up to 50%. Reduced CO₂ emissions also help you win contracts in environmentally sensitive areas.

MORE EFFICIENCY AND OVERVIEW WITH RM XSMART

Whether via mobile phone app, or via fleet management and condition monitoring: you have access to your machines at all times, are informed about their status, have an overview of operating data and can quickly solve any issues that arise.

FUTURE-PROOF

With RM, you are not only well equipped for current requirements, but also have the option of expanding your business at a later date with additional suitable and aligned RM machines. In addition, RM develops innovative technologies with regard to machine-to-machine communication to make the systems even more efficient.



Welcome! to our world



[RUBBLEMASTER.COM](https://www.rubblemaster.com)

EN 419825 RM All-In-One Screen 06/2023 EN

RUBBLE MASTER HMH GmbH
Im Südpark 196, AT 4030 Linz, AUSTRIA
Tel: +43 732 - 73 71 17 - 0
Fax: +43 732 - 73 71 17 - 101
E-Mail: sales@rubblemaster.com
WEB: RUBBLEMASTER.COM

