

**BIAS**  
MÜHENDİSLİK

Yenilikçiler için Çözümler  
*Solutions for Innovators*

Bias Engineering  
Advanced Engineering Solutions

Vatan Özgül  
Business Development Manager



# About

## Advanced Engineering Solutions

- Founded in 1997.
- İstanbul, Ankara, Bursa and İzmir Offices.
- TOSB Bias Automotive Test Center 
- Ankara Factory.
- +145 employees (%60 engineers)
- ISO 9001:2015; ISO 45001:2018; ISO 14001; ISO 17025



# History

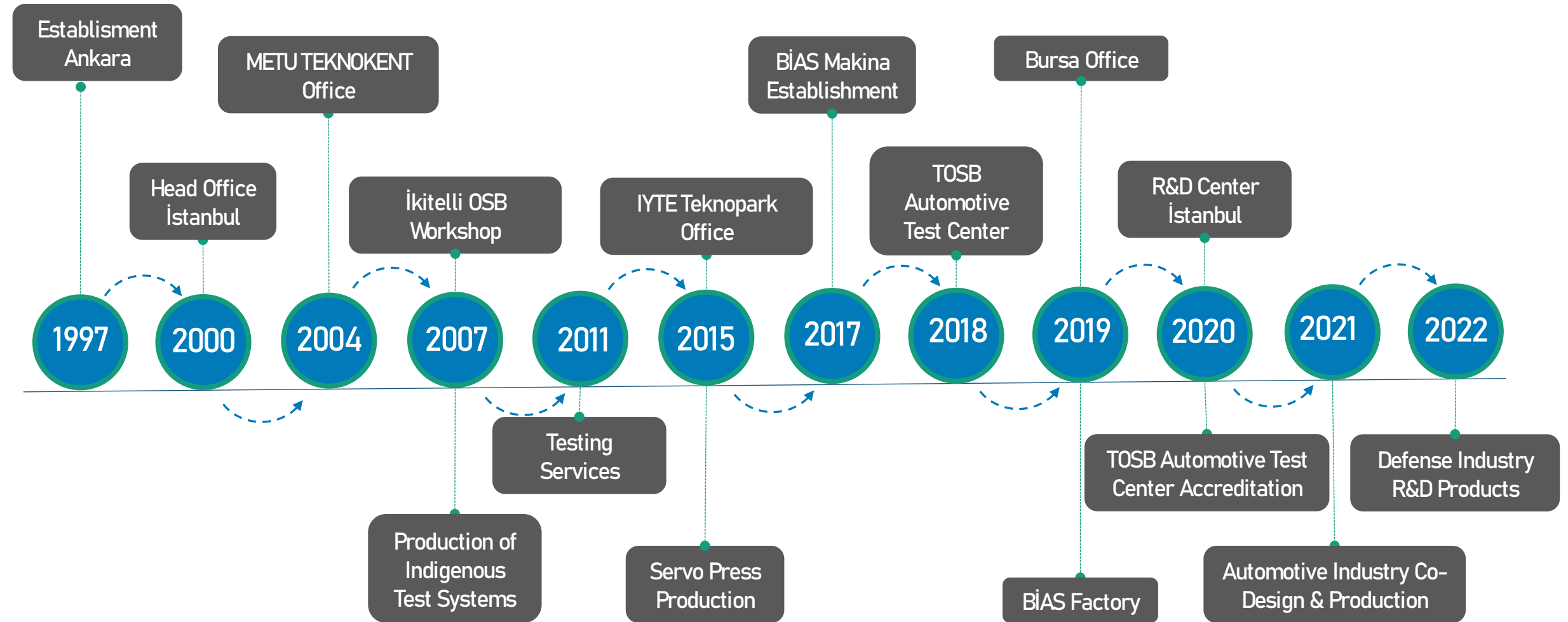



# Fields of Activity

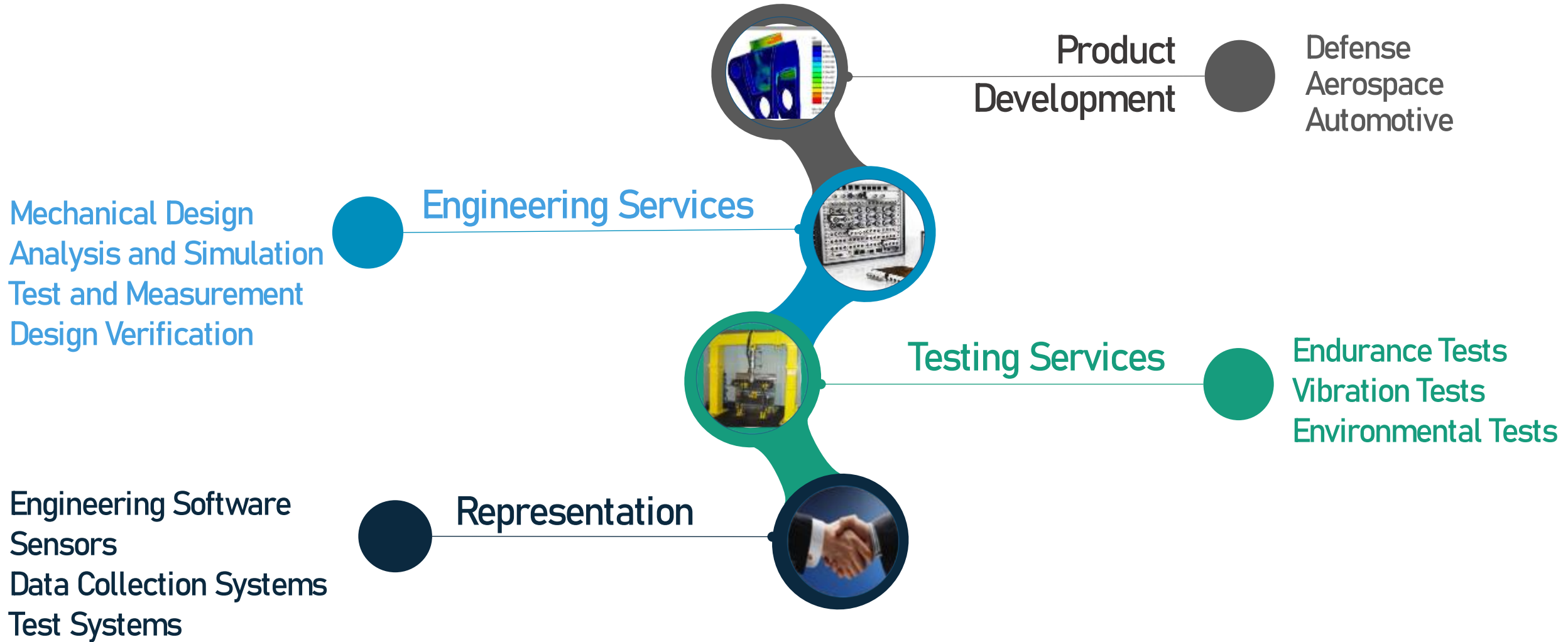

# Product Development / Defense Industry Subsystem Solutions

Weapon systems electromechanical platforms  
Satellite and missile transportation platforms  
Ammunition loading mechanisms  
Armored vehicle track design optimization  
Power transmission systems  
Canisters, Pods and Launcher structures.

## Test Platforms

- Gun Fire Test System
- Pyro shock Test System
- Structural Test Rig
- Acoustic Characterization



# Engineering Services

## Analysis and Simulation

- Endurance, Fatigue
- Vibration & Shock, NVH
- Vehicle Dynamics, Machine Dynamics
- CFD, Thermal
- Explicit Analysis (Explosion, Drop etc.)
- Composite Structures, Rubber
- Metal Forming

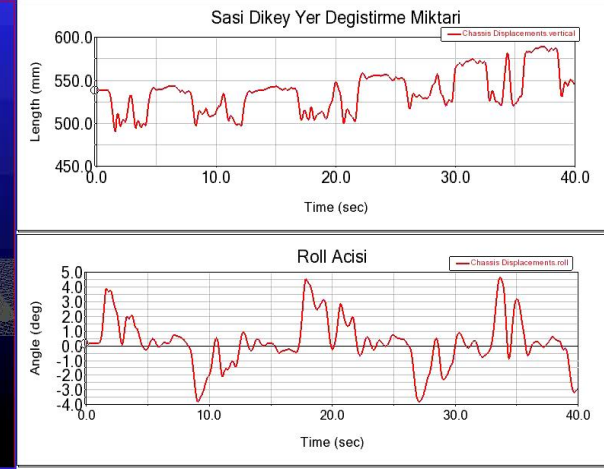
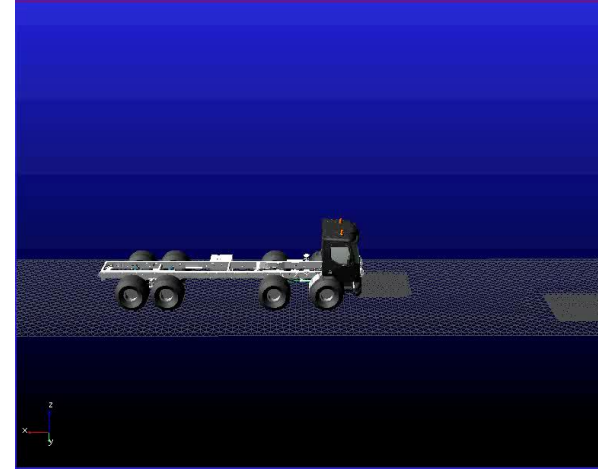
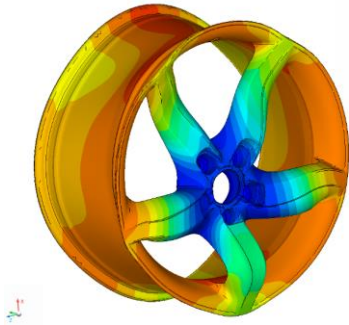
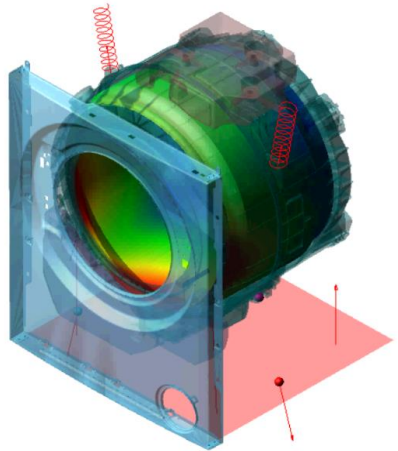

LS-DYNA KEYWORD DECK BY LS-PRE  
Time = 0

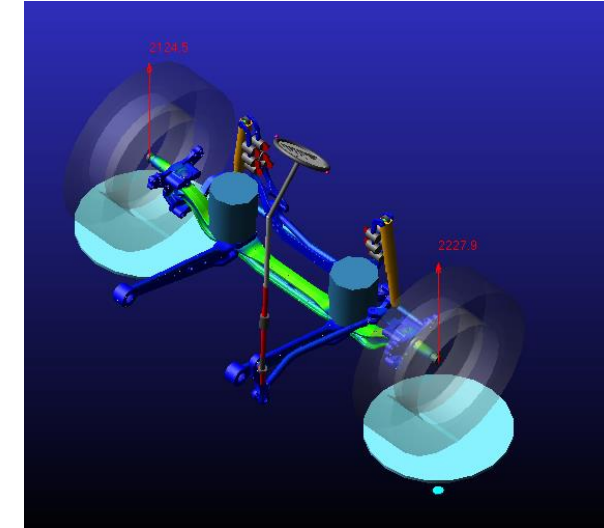
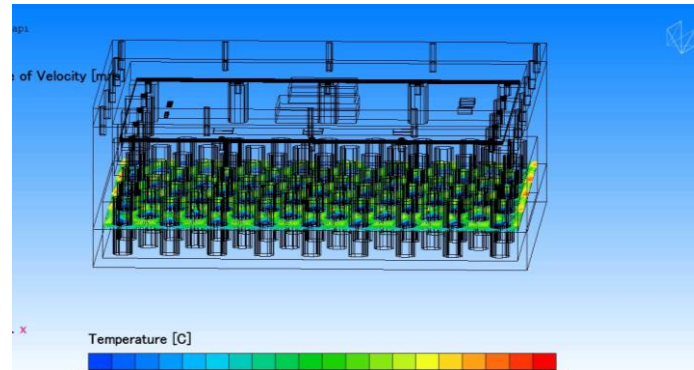
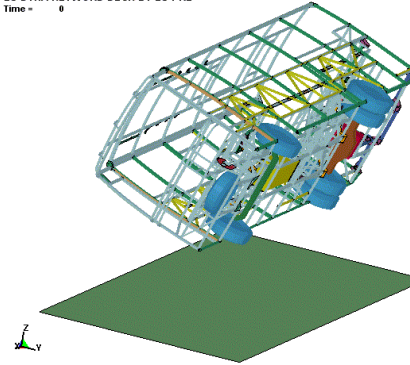



# Engineering Services

## Test & Measurement, Design Verification

- Field Measurements (Strain, Force, Torque etc.)
- Vibration and Noise Measurements
- Data (RLD) processing
- Modal Test
- Vibration & Shock Tests
- Accelerometer Calibration
- Motor Tests
- Durability and Life

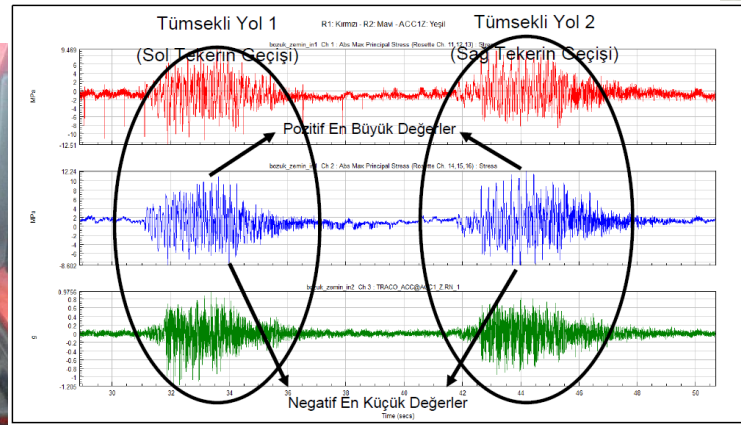

km	200000	350000	200000	150000	50000	50000	1.0E+06	
Yol Tipi	1. Kalite	2. Kalite	3. Kalite	4. Kalite	5. Kalite	6. Kalite	Toplam Hasar	Toplam Ömür [Milyon km]
R1_dik	8.60E-02	8.92E-02	5.11E-01	1.74E+00	1.58E-01	1.76E-01	2.7584	0.36
R1_paralel	0.00E+00	0.00E+00	0.00E+00	1.02E-03	0.00E+00	0.00E+00	0.0010	982.10
R2_dik	1.60E-02	4.25E-02	1.98E-01	1.02E+00	6.99E-02	1.00E-01	1.4483	0.69
R2_paralel	0.00E+00	0.00E+00	0.00E+00	1.83E-03	0.00E+00	0.00E+00	0.0018	546.31
R3_dik	2.82E-01	1.44E-01	6.90E-01	1.92E+00	3.34E-01	1.61E-01	3.5283	0.28
R3_paralel	0.00E+00	0.00E+00	0.00E+00	0.00E+00	0.00E+00	0.00E+00	0.0000	Sonsuz Ömür
R4_dik	2.69E-01	1.10E-01	6.11E-01	1.92E+00	2.68E-01	1.54E-01	3.3304	0.30
R4_paralel	0.00E+00	0.00E+00	0.00E+00	1.21E-04	0.00E+00	0.00E+00	0.0001	8238.82
L1	0.00E+00	0.00E+00	0.00E+00	2.14E-03	0.00E+00	0.00E+00	0.0021	466.76
L2	0.00E+00	0.00E+00	0.00E+00	0.00E+00	0.00E+00	0.00E+00	0.0000	Sonsuz Ömür
L3	0.00E+00	0.00E+00	0.00E+00	0.00E+00	0.00E+00	0.00E+00	0.0000	Sonsuz Ömür
L4	0.00E+00	0.00E+00	0.00E+00	2.12E-02	9.53E-04	5.06E-04	0.0226	44.18
L5	0.00E+00	0.00E+00	0.00E+00	1.38E-02	0.00E+00	0.00E+00	0.0138	72.54
L6	0.00E+00	0.00E+00	0.00E+00	4.37E-03	0.00E+00	0.00E+00	0.0044	229.07
L7	0.00E+00	0.00E+00	0.00E+00	0.00E+00	0.00E+00	0.00E+00	0.0000	Sonsuz Ömür
L8	0.00E+00	0.00E+00	0.00E+00	0.00E+00	0.00E+00	0.00E+00	0.0000	Sonsuz Ömür





Yapısal Dayanım ve Ömür Testleri



Air Conditioning Cabinets



Electrodynamic Shaker



Accelerometer Calibration System

Motor Test Dinamometresi



Standards

MIL STD 810, NAVMART, RTCA, ISO  
TÜRKAK ISO 17025 accreditation



TOSB BİAS Video



Pressure-Vacuum Cyclic Test System



Cyclic Salt-Corrosion Test Cabinet



Hydraulic Vibration Test System



Click for Test Services Video:



# Testing Services

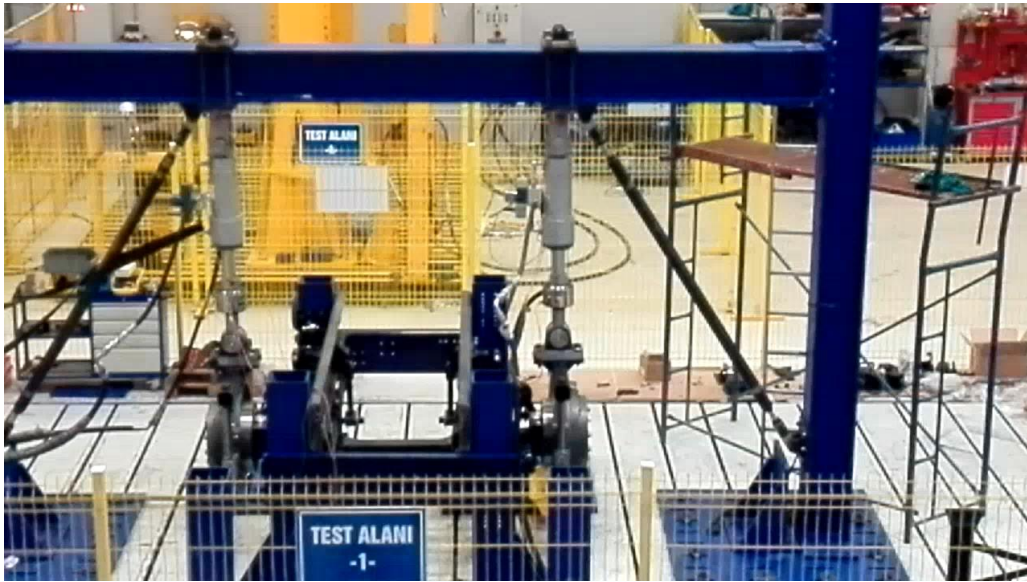
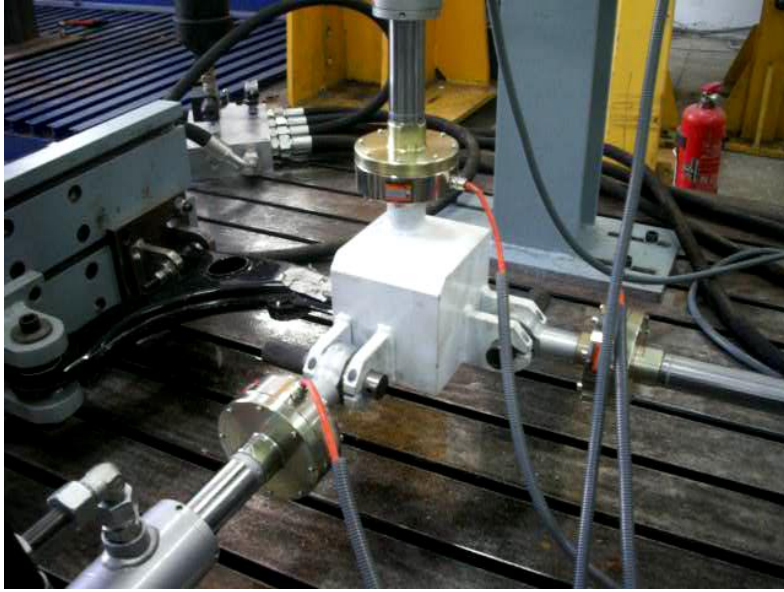



# Examples from Projects

## Ammunition Transport Unit

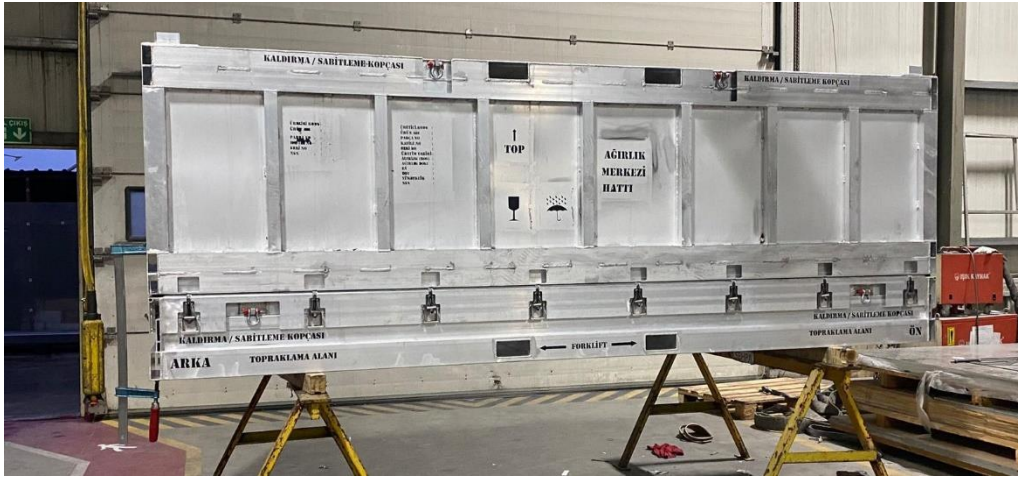

## Accelerated Life Test

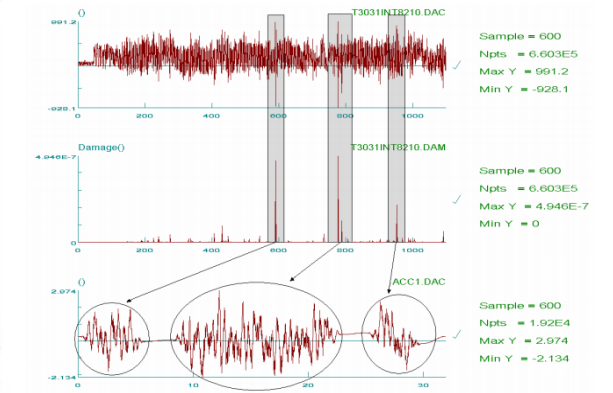
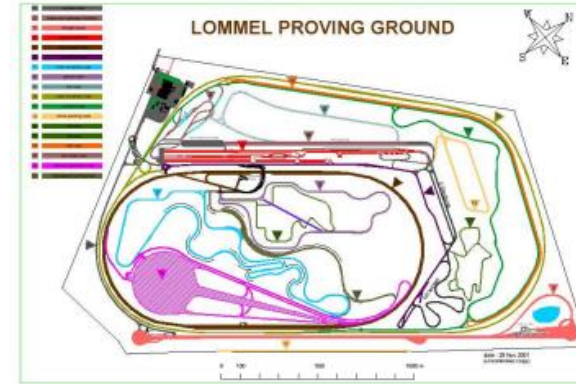



# Examples from Projects



Landing Gear Drop Test Tower  
Design, Analysis, Manufacturing

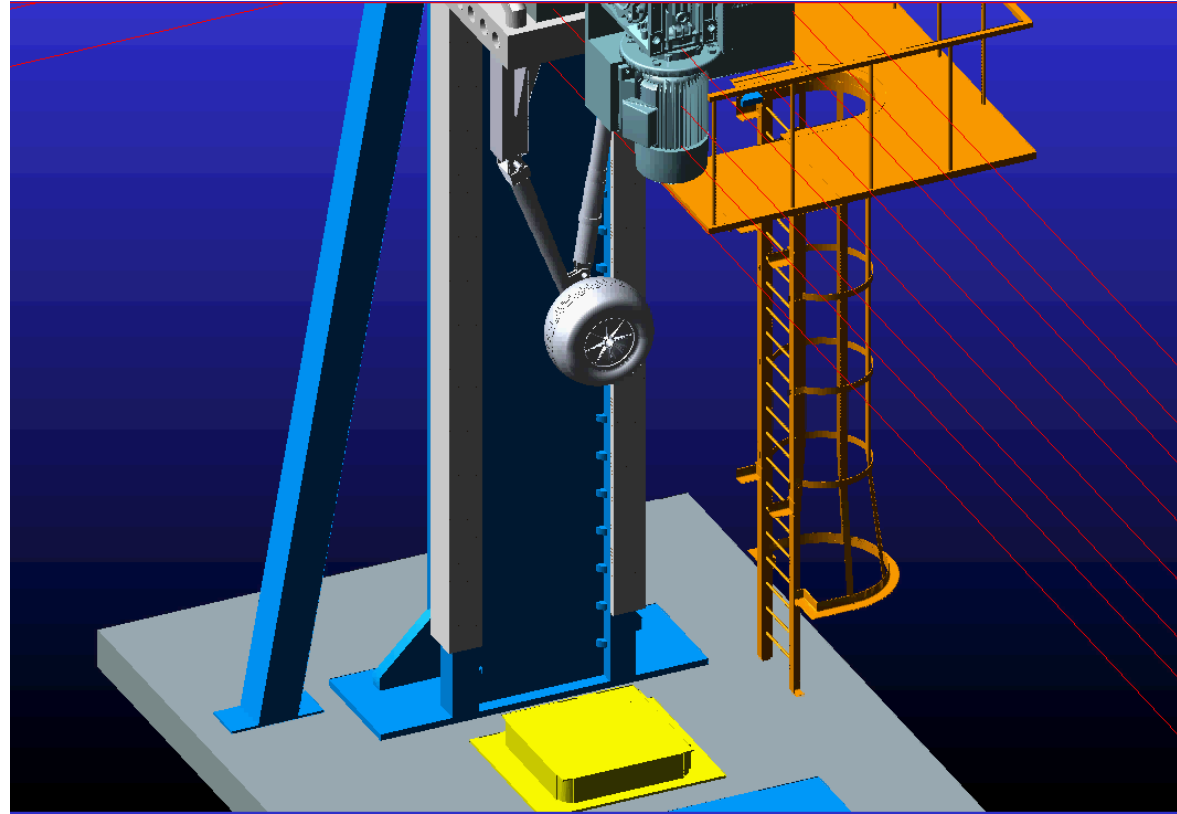

# Examples from Projects

D3PLOT: JODDB\_Mine\_Blast  
1: Max H377823: -0.000000E+00, Min H377823: -0.000000E+00

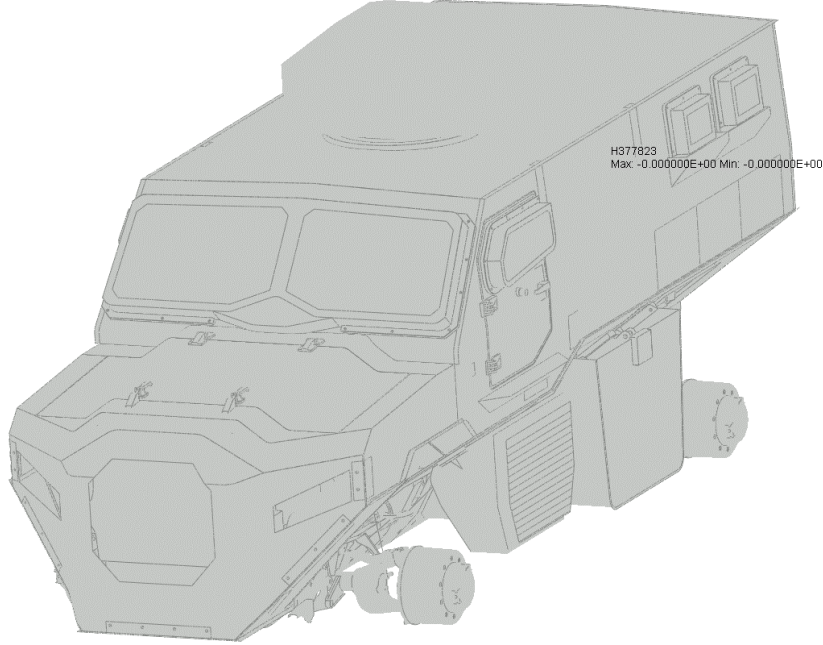

Von Mises Stress  
(Max all pts)

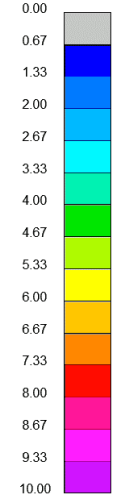

x 1.0E-03



.000000000

140degree\_4kgmine\_10mmthickness  
Time = 0

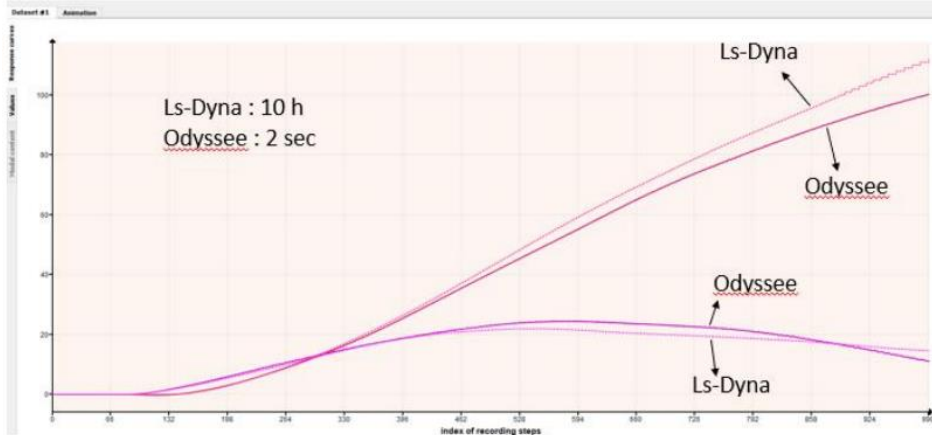
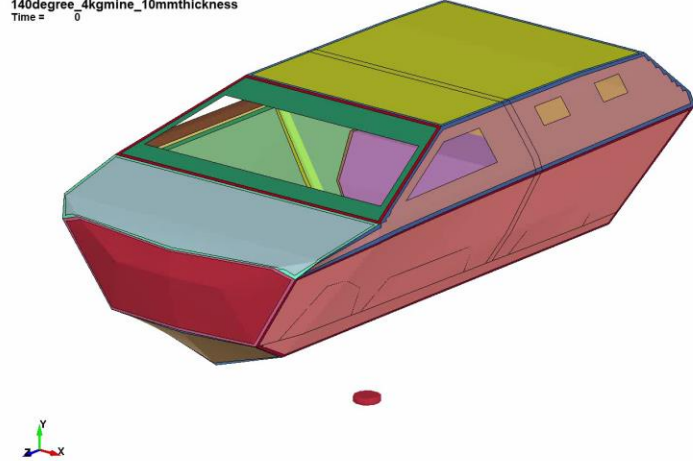

Şekil 5. Dikey Deplasman Sonucu Doğrulama Analizleri

## Mine Explosion Sim. Result Estimation with ML

SAVTEK 2022, 10. SAVUNMA TEKNOLOJİLERİ KONGRESİ  
13-15 Eylül 2022, ODTÜ, Ankara

### MAYIN PATLAMA SİMÜLASYONUNUN SONUÇ TAHMİNİ İLE OPTİMİZASYONU

Umut Can SALMAN <sup>(a)</sup>, Namık KILIÇ <sup>(b)</sup>, Sercan DEVRİM <sup>(c)</sup>

<sup>(a)</sup> Mekanik Simülasyon Mühendisi, BİAS MÜHENDİSLİK, İstanbul, [ucsalman@bias.com.tr](mailto:ucsalman@bias.com.tr)

<sup>(b)</sup> AR-GE Direktörü, BİAS MÜHENDİSLİK, İstanbul, [nklic@bias.com.tr](mailto:nklic@bias.com.tr)

<sup>(c)</sup> Yapısal Analiz Mühendisi, BİAS MÜHENDİSLİK, İstanbul, [sdevrim@bias.com.tr](mailto:sdevrim@bias.com.tr)

# Representation Services / CAE – Engineering Software

Structural

System  
Dynamics

CFD

Manufacturing  
Simulations

Optimization

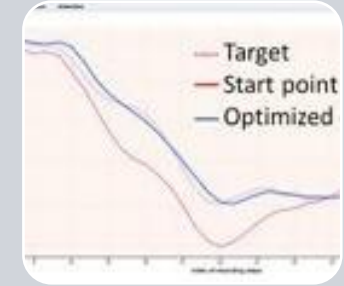
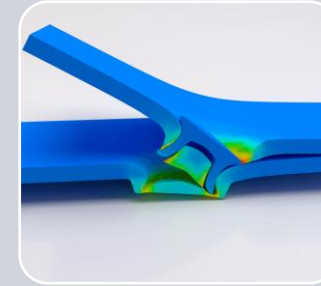
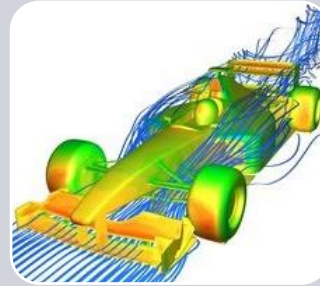
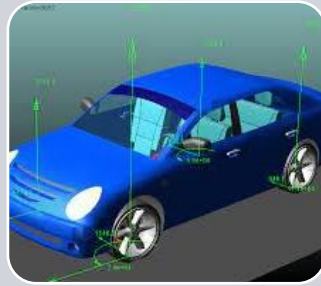
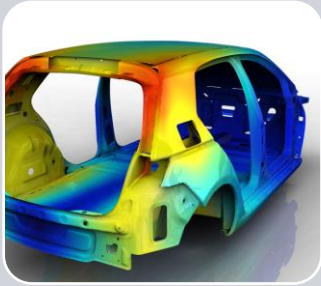

- MSC.Nastran
- Marc
- MSC.Apex
- CAEFatigue
- Ls-Dyna

- Adams
- Romax
- Actran
- Elements

- Cradle CFD
- Picles

- Simufact AM
- Simufact Weld.
- FTI Forming
- Apex Gen. Des.

- Odyssee
- P7

**DYNA**  
MORE

 **HEXAGON**

Authorised Hexagon Partner

 pSeven



# CAE Solutions / Disciplines

*Structural Analysis and Durability*

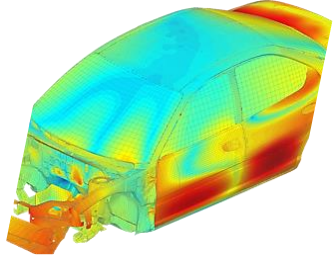

*System and Vehicle Dynamics*

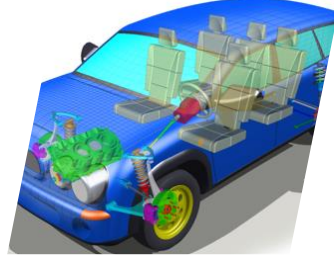

*Thermal and Fluid Dynamics*

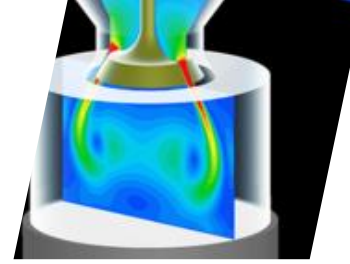

*Optimization and Machine Learning*

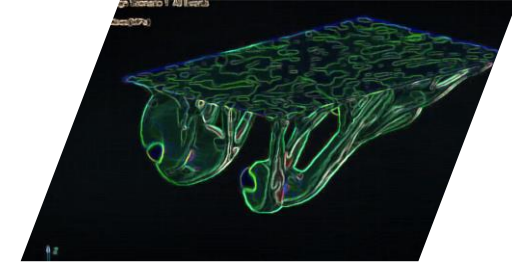

*Acoustic*

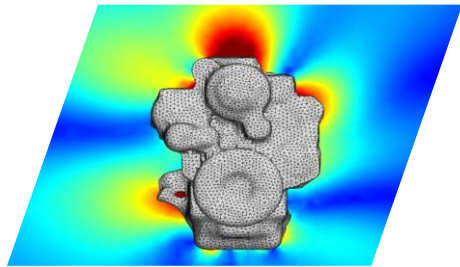

*Computational Material*

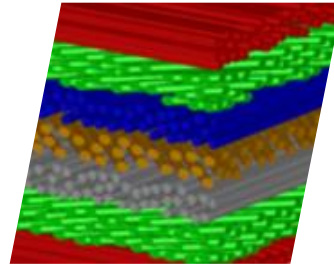

*Manufacturing Simulations*

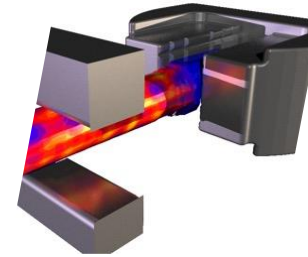

*Workflow Automation*



*Noise and Vibration, NVH*

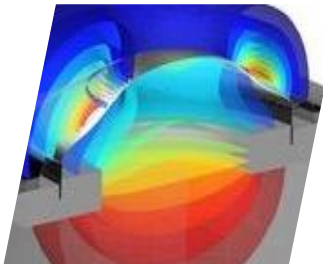

*System and Control*

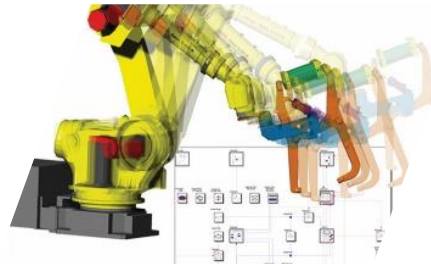

*Co-Simulation*

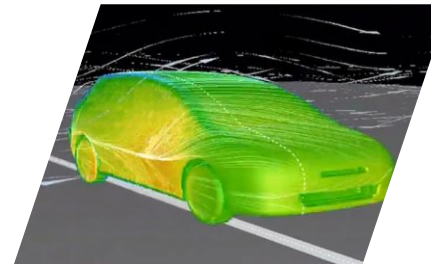

*... and more!*

# Representation / Test & Measurement

## Environmental Test Systems



- Electro-Dynamic Shakers
- Climate Chambers
- Salt-Rain-Dust and Solar Test Chambers
- Vibration & Shock Controller

## Structural Test Systems



- Data Acquisition Systems
- Sensor (Strain gage, Loadcell, Tork Sensor)
- DIC and Fiber Optic Strain Measure.
- Residual Stress Measure. Systems
- Rezonance Fatigue Test Systems

## Noise, Vibration



- NVH Analyzer
- Sensor (Accelometer, Microphone, Pressure Sensor)
- Acoustic Camera
- Modal Shaker

## Flow Measurement Systems

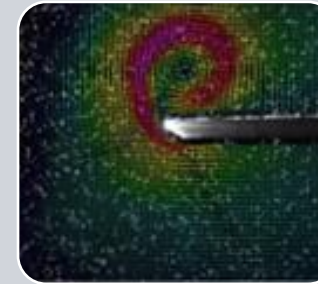

- PIV -Particle Image Velocimetry
- LDA - Laser Doppler Anemometry
- CTA - Constrant Temp. Anemometri
- LIF - Laser Induced Fluorescence
- Multi-hole Probe, Pitot-Static Probe

## ADAS & OTONOMY



- INS Measure. Systems
- LIDAR
- ADAS Targets
- Driving Robots
- Ground Truth Referance Measure. Systems



# Test & Measurement Solutions

## Strain Applications

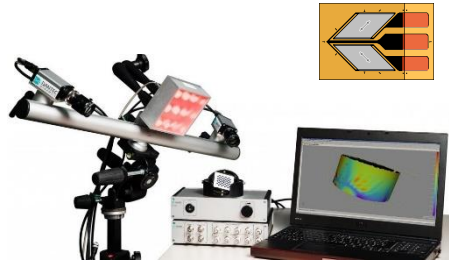

## Noise and Vibration

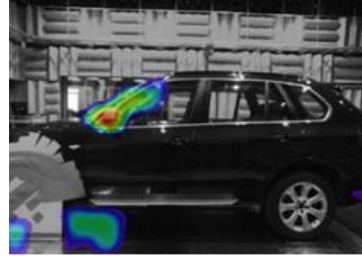

## Force and Torque Sensors



## Data Collection Systems

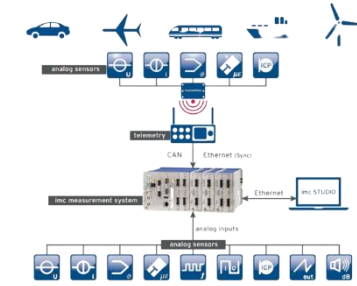

## ADAS and Autonomous Vehicle



## Fatigue Applications

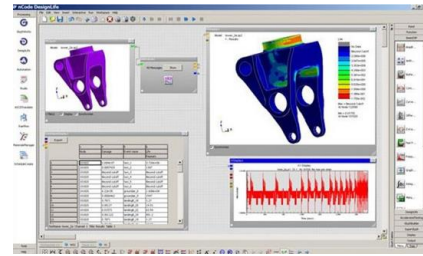

## Environmental Test Systems



## Residual Stress, Heat Treatment Defect, NDT

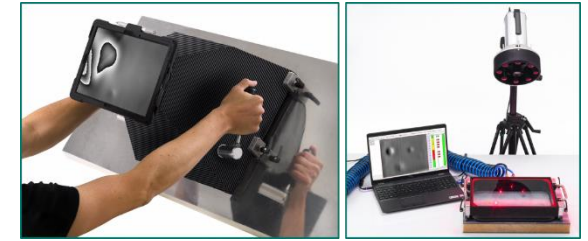

## Flow Measurement Systems



## Vehicle Test Systems



## Bias R&D Measurement Systems



## Education, Consulting





# Man Power

## 91 ENGINEERS

ADAS Software Engineer	Maintenance Manager	CAE Engineer	Hardware Design Engineer	R&D Engineer	Quality Engineer	Project Engineer	Purchasing	Sales Engineer	Health Environment Manager	System Design Engineer	Design Engineer	Test Engineer	Test-Measurement Engineer	Incentive Management	Manufacturing Engineer	Senior Management	Software Engineer
7	1	24	1	2	5	5	1	9	1	2	10	11	6	1	1	3	1



# Solution and Collaboration

Product Development (from conceptual design -> production)

Electro-Mechanical Systems

Test Systems

Environmental Testing Services

Mechanical Testing Services

Measurement Services

Field Applications

Road Data Collection and Processing

Vehicle Instrumentation

Analysis and Simulation Services

Joint R&D Project Development

Solution Supply

CAE Software

Measurement Systems, Analyzer, Sensor

Environmental Test Systems

Electrodynamic Shakers

**BIAS**  
MÜHENDİSLİK

Yenilikçiler için Çözümler  
*Solutions for Innovators*

Thank you!

