



**CYBERAPEX**  
TECHNOLOGY

>>> 唯城科技有限公司  Cyberapex Technology Co., LTD. <<<

# Contents

1

INTRODUCTION

公司介紹

2

CORE VALUES

核心價值

3

MANUFACTURING &  
QUALITY ASSURANCE

製造及品質保證

4

PRODUCT

產品

<https://cyberapex.en.taiwantrade.com/>



CYBERAPEX Technology Co., Ltd. is a technology-driven company specializing in the design, development, and manufacturing of high-quality electronic connectors. We provide reliable, customizable interconnection solutions for a wide range of industries, including industrial automation, automotive electronics, telecommunications, consumer electronics, and medical devices.

## MILE STONE

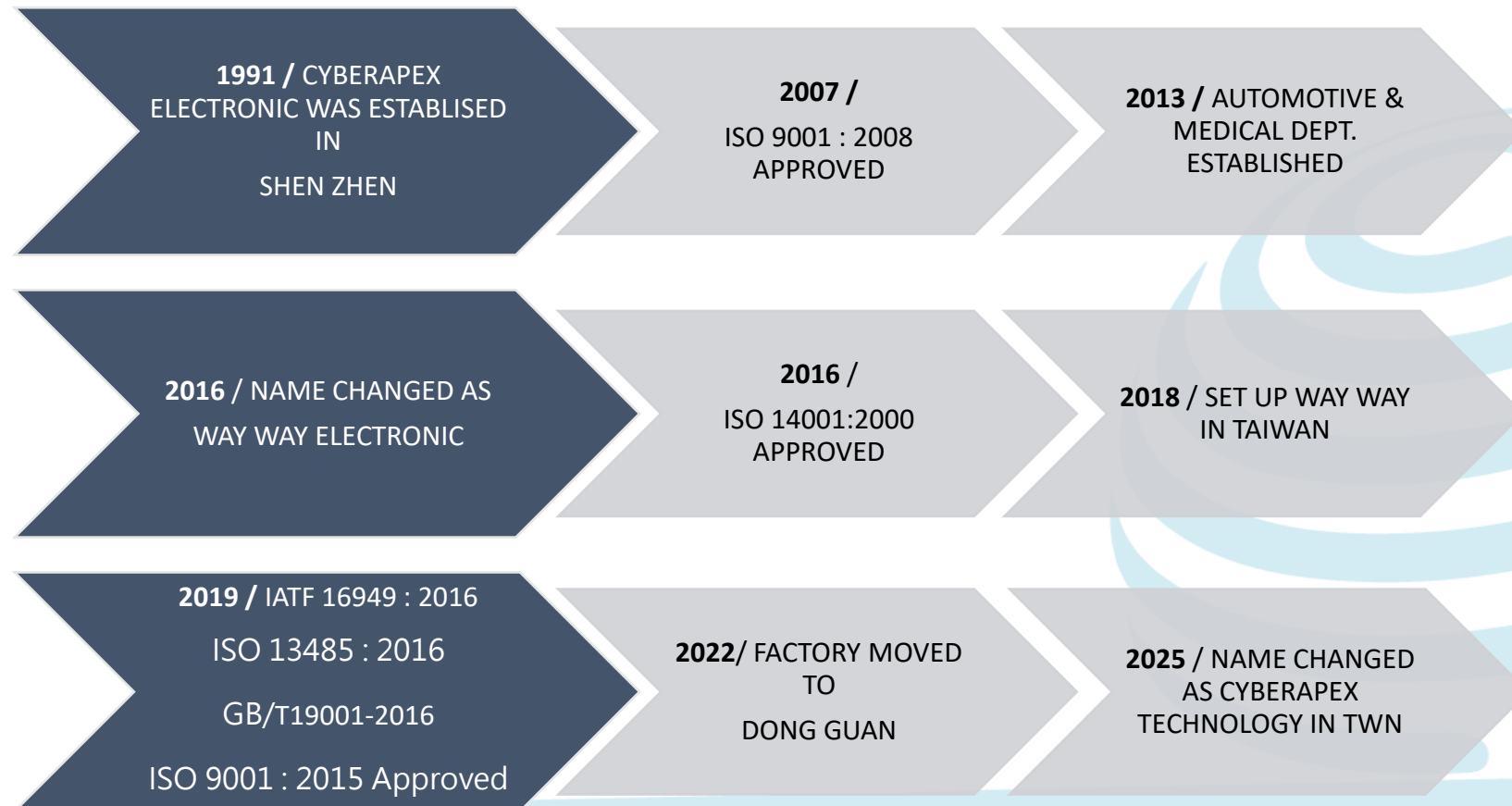

## FACTORY STATUS



WayWay Factory



Employees : 160

Engineers : 15

QC Staff : 12

## CUSTOMERS



## R&D and design capabilities

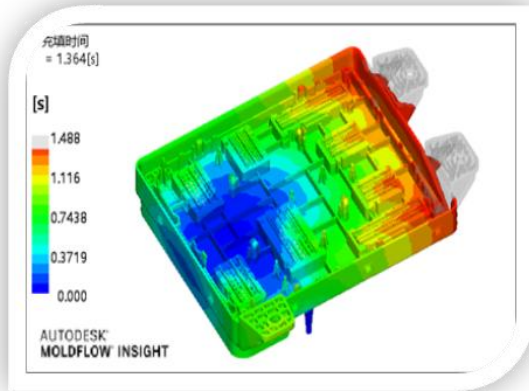

CYBERAPEX covers the full value chain — from product design and mold development to automated production.

This integration improves efficiency, flexibility, and ensures consistent quality.

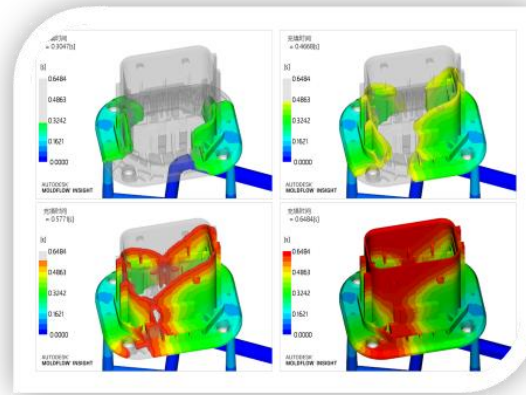
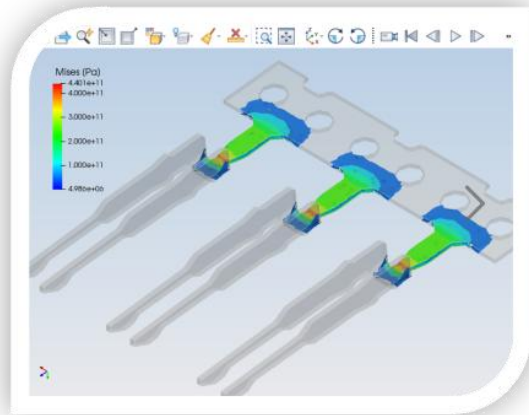

## Sample Development Methods

### 1. 3D Printing



For concept validation and initial design review.

### 2. Soft Tooling (Silicone Mold Sample)

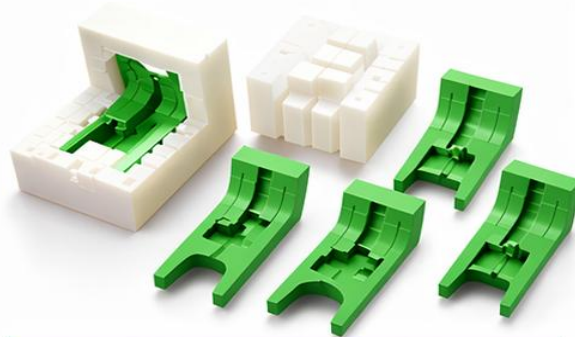

For functional testing and fit evaluation.

### 3. Hard Tooling (Steel Mold Sample)



For high-precision verification and pre-production validation.



All three methods are **initial sampling approaches** used to verify design and performance before mass production.

## R&D and design capabilities

– 3D schematic diagram /CUSTOMIZED / ODM

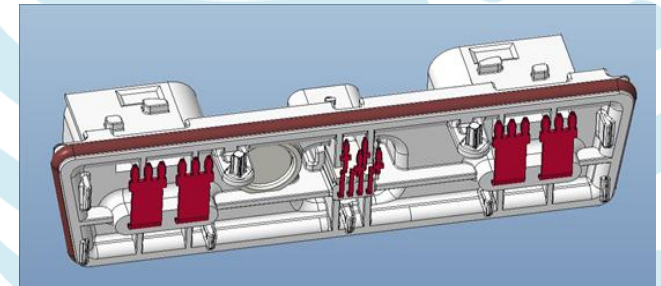
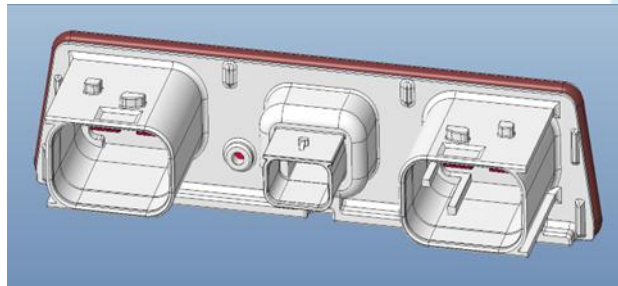
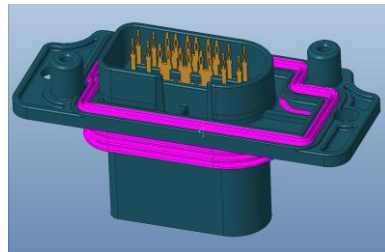
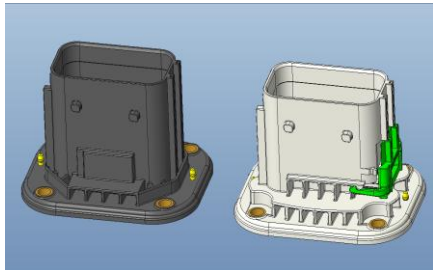
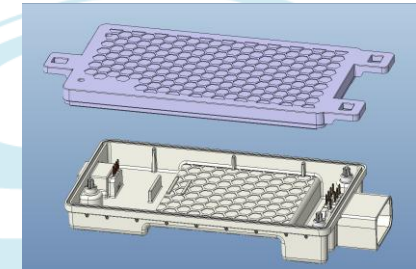
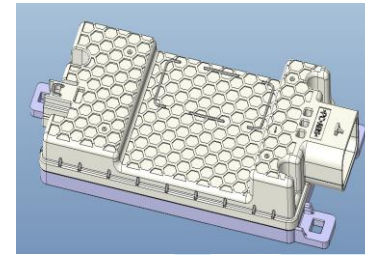
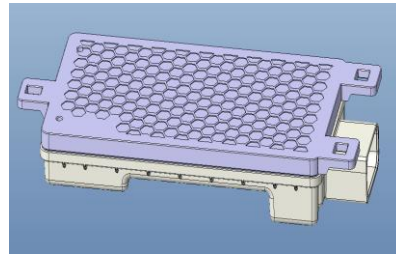
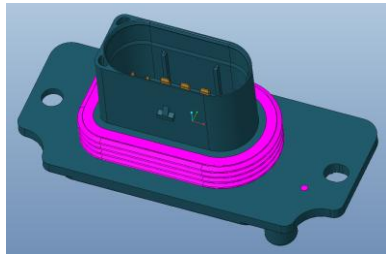
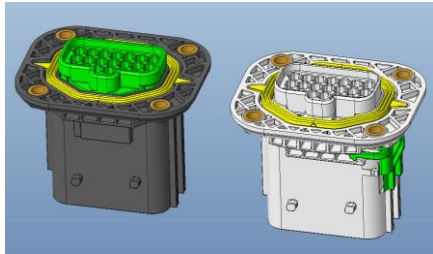

## Precision Mold Development & Manufacturing

### ➤ Project Description: Customized Large Plastic case

- Product Application: Automotive
- Product: Insert molding (8 connectors + Base)
- End User :



SIZE: 25.5CM \* 20.9CM \* 5.8CM

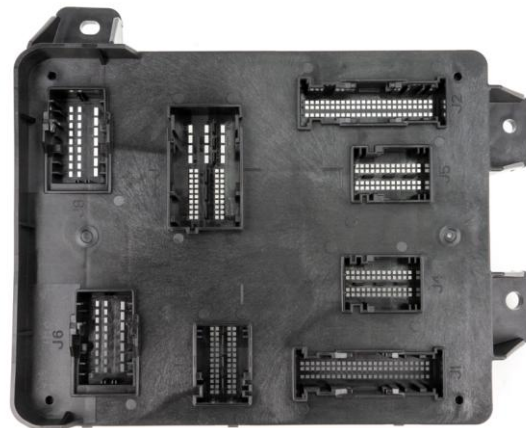
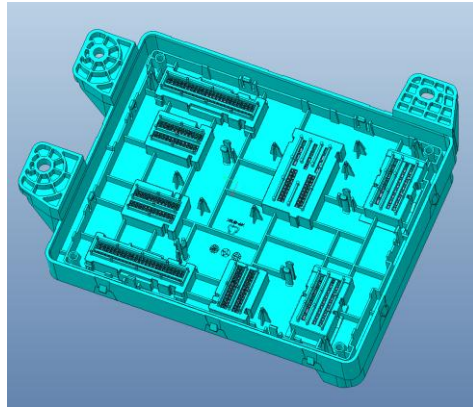
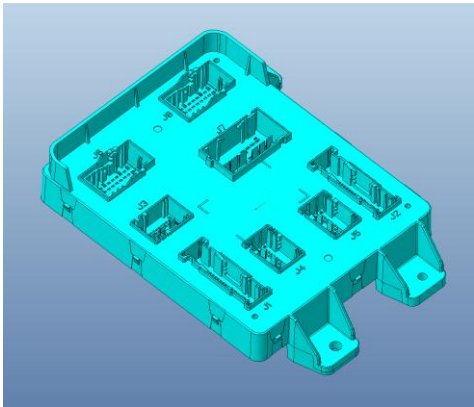

## Precision Mold Development & Manufacturing

### ➤ Project Description : Cuctomized

- Product Application: Gas Box (Honeywell) / Automotive
- Product: Special Injection Products
- End User : **Honeywell** 

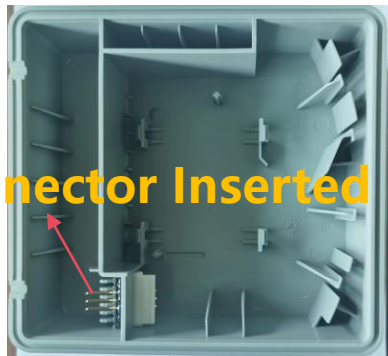

Finished Size : 180mm X 165mm X 55mm  
Equipment : Injection Machine 280T  
Material : PP  
Weight : 277g(Base)+124.6g(Cover)

Finished Size : 180mm X 165mm X 55mm  
Equipment : Injection Machine 280T  
Material : PPS  
Weight : 190.6g



Finished Size : 250mm X 250mm X 25mm  
Equipment : Injection Machine 280T  
Material : PPS  
Weight : 901.8g

## Problem-Solving Mindset with End-to-End Solutions

### ➤ Project Description : Customized

- Product Application: Medical
- Product: Glucometer Conn.
- End User : **OMRON**

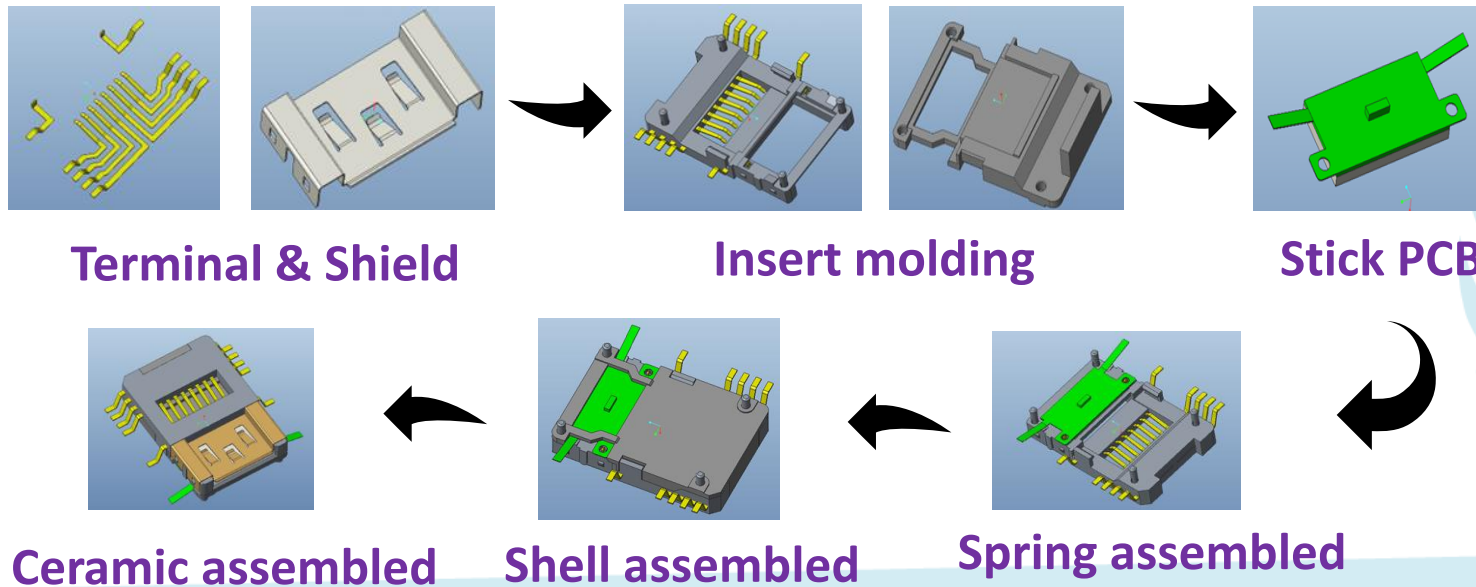

## Problem-Solving Mindset with End-to-End Solutions

### ➤ Project Description : Customized

- Product Application: Steering wheel control system
- Product: HORIZONTAL\_SOCKET PRESS FIT 2\*3P
- End User :

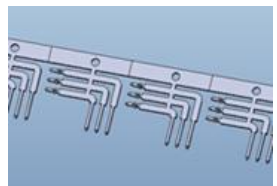

Terminal

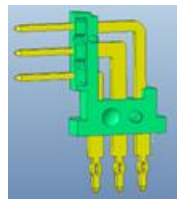

1<sup>st</sup> molding

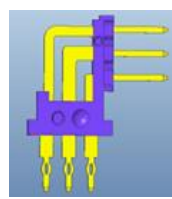

Combined

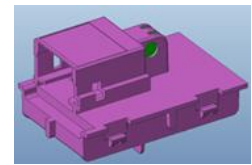
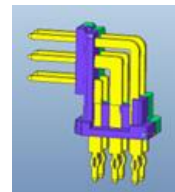

Finished

3<sup>rd</sup> molding

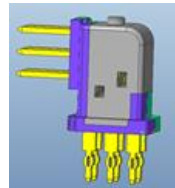

2<sup>nd</sup> molding

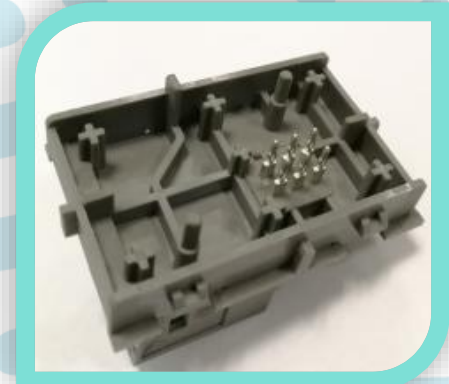
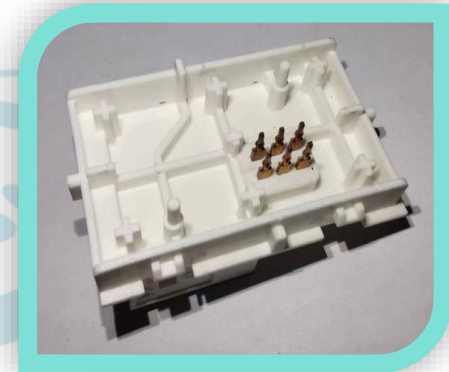
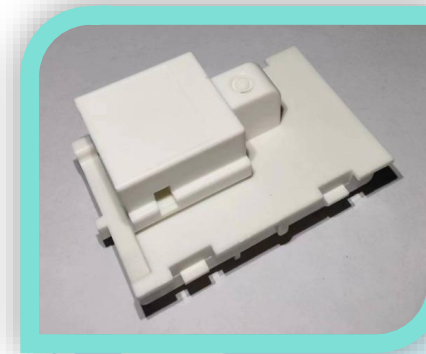

## Global Reach and Commitment to Excellence



## PLASTIC EQUIPMENTS

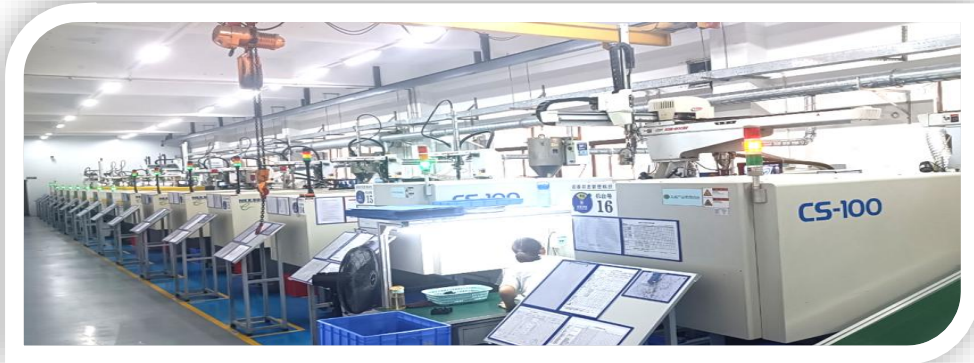

FANUC roboshot Horizontal  
electric forming machine

30T      2 stations

50T      7 stations

Victor Taichung Horizontal  
electric forming machine

150T      1 stations

**DE RON Vertical Molding  
Machine**

55T      7 stations

NISSEI roboshot Horizontal  
electric forming machine

30T      2 stations

50T      3 stations

Toyo roboshot Horizontal  
electric forming machine

100T      2 stations

## METAL PRODUCT EQUIPMENT

	Brand	Specification	Amount
1	JIN Feng	110T	2
2	Shuang Xiang	65T	1
3	DOBBY	60T	1
4	Xing Shun Kang	45T	5
5	Ying Yu	40T	2
6	Shuang Xiang	35T	1
7	Xing Shun Kang	30T	3
8	Dobby	25T	3
	<b>Total:</b>		<b>18</b>



## PRODUCTION LINE



## CERTIFICATION – ISO & IATF 16949



## CERTIFICATION- PATENTS

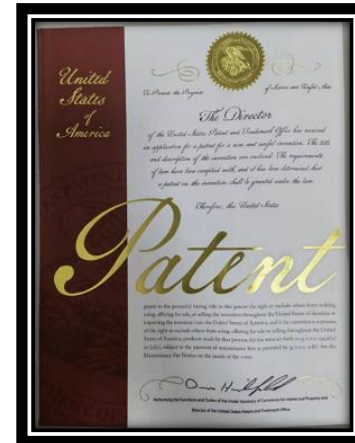

## QUALITY ASSURANCE



### Environment test

Temperature Test / Corrosion Test



### Reliability test

CP&CPK、Paint / coating hardness test 、  
Operability Test



### Environmental Protection test

RoHS / REACH / GP / MSDS



### Mechanical test

Dynamic Load Test 、 Durability Test



### Electrical test

Electrical Voltage - Input/Output Test



### Other test

Impact resistance test 、 Drop test



### Test standard

SAE/USCAR、 LV214、 VW 75174、 VW 80332、 GMW3191

## QUALITY ASSURANCE

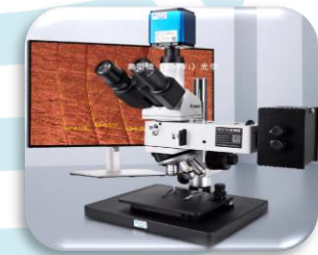
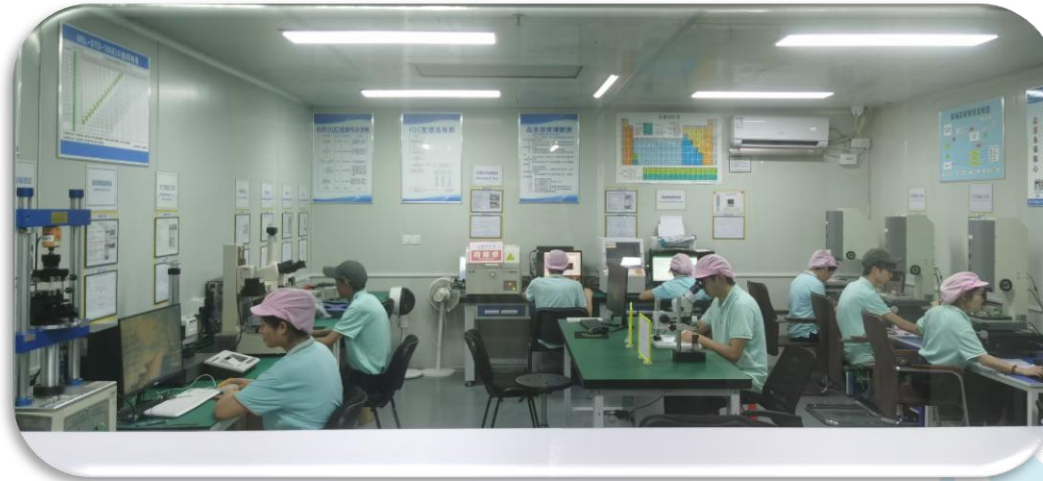





## LABTORY

### LABTORY LIST







LAB LIST

	EQUIPMENT	BRAND/TYPE	TESTING PURPOSE	TESTING RANGE	PICS	QTY
1	Environmental tester	Seiko Instruments Inc/SEA1000A	Hazardous elements specified by the RoHS Directive ( Cd/Pb/Cr/Hg/Br ) Harmful elements specified in RoHS directive (limited to Cd/Pb/Cr/Hg/Br)	Element content analysis range : 1ppm-99.99% Element content analysis range: 1ppm-99.99%		1Set
2	X-ray coating thickness gauge	FISCHERSCOPE X-RAY XULM-XYm	Testing plating thickness	Precision :0.001u"		1Set
3	Automatic inserting and drawing machine	Aisry/1220S	Insertion force/pullout force/insertion life/retention force/forward force	0-50KG		1Set
4	Keyence One Click Measuring Instrument	Keyence IM8020	One click measuring instrument	300mm*200mm (Precision 2-3.9um)		1Set
5	Tool Microscope	Nikon/MM-40	Size measurement	Precision:0.001mm		1Set





## LABTORY

### LABTORY LIST

	EQUIPMENT	BRAND/TYPE	TESTING PURPOSE	TESTING RANGE	PICS	QTY
6	Secondary yuan	VMS-2515G/VMS-2010G	Size measurement	X.Y range : 250mm*150mm , Precision : 0.001mm		3Set
7	IR Reflow	Japan HTC NC06M-123 (12 Temp. zone)	High temperature test, weldability test	300°Max		1Set
8	Salt fog tester	Aisry	Salt spray test	/		1Set
9	Withstand pressure tester	Tonghui/TH9301A	Withstand voltage test	AC : 5KV/DC : 6KV Max		1Set
10	Insulation impedance tester	Tonghui/TH2683	Insulation impedance test	电压 : 1000V Max 电阻 : 1000GΩ Max		1Set





## LABTORY

### LABTORY LIST

	EQUIPMENT	BRAND/TYPE	TESTING PURPOSE	TESTING RANGE	PICS	QTY
11	Micro ohmmeter micro resistance tester	CHEN HWA/CH-5011	Contact impedance	1uΩ~2MΩ		1Set
12	Little tin stove	CMW/CM508	Tin test	300°C Max		1Set
13	Magnifying Glass (10x)	/	A visual inspection	10 times magnification		1Set
14	Microscope (40 x)	MIC-210	A visual inspection	20X-40X		2Set
15	Height gauge	TERMATOOLS	Measuring height dimension	RANGE : 0~25.4mm, PRECESION : 0.01mm		1Set

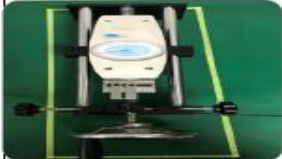



## LABTORY

### LABTORY LIST

	EQUIPMENT	BRAND/TYPE	TESTING PURPOSE	TESTING RANGE	PICS	QTY
16	Manual tension tester (tension meter)	ALGOL	Tensile tests	20kgf/200kgf		2Set
17	Two in one hot air desoldering stand	YAOGONG/852D+	Unsolder/solder	100°C~500°C		1Set
18	The thermometer	TES	Test IR& small tin oven temperature	负50°C~1300°C		1Set
19	Wire tester	HC-6360	Short/open circuit & high voltage insulation testing	1MΩ~500MΩ /100V~1000VDC , 100V~500VAC		1Set
20	Surface roughness tester	Mitutoyo SJ-410	Test product surface roughness	800μm-0.01μm		1Set



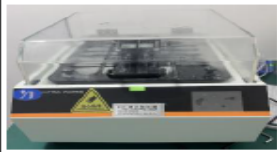

## LABTORY

### LABTORY LIST

	EQUIPMENT	BRAND/TYPE	TESTING PURPOSE	TESTING RANGE	PICS	QTY
21	CD BOX DRYER	DGOWADA	Test product high temperature life	30-300°C		1Set
22	Electric blast constant temperature drying oven	S.S./101-2BS	Test product high temperature life	30-300°C		1Set
23	Metallographic sample grinding and polishing machine	MP-2	Product profiling	N/A		1Set
24	Desktop type automatic precision cutting machine	Yudo-230E	Product profiling	N/A		1Set
25	Constant temperature and humidity testing chamber	H.T /HT-S-80L	测试产品极端环境类测试 Extreme environment testing of test products	Temperature range: -60°C to 150°C Humidity range: 20% - 98%		1Set

## LABTORY

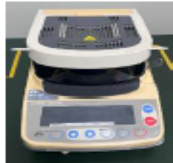
### LABTORY LIST

	EQUIPMENT	BRAND/TYPE	TESTING PURPOSE	TESTING RANGE	PICS	QTY
26	Thermal shock testing chamber	HT-LC-50L	Extreme environment testing of test products	:-60°C-150°C		1Set
27	Horizontal insertion and extraction force tester	HT-C8	Test the insertion and removal life of the product.	0.01N-200N		1Set
28	Moisture tester	JAPAN AND-50	Test the moisture content of the product.	0.01%-100% Moisture analysis range: 0.01% - 100%		1Set
29	hardness tester	NAKAZAWA 401MVA-P	Test the hardness of the material.	HV : 1-800		1Set

## Product Portfolio



**Consumer Electronics  
Connectors**



**Automotive  
Connectors**



**Medical Connectors**



**Industrial Connectors**



**Communication Connectors**

## AUTOMOTIVE SERIES/ Customized



## AUTOMOTIVE SERIES

### MINI FAKRA SERIES



## Medical connectors Series



## Industrial connector Series



## Industrial connector Series



## Consumer connector Series

### HDMI / USB SERIES

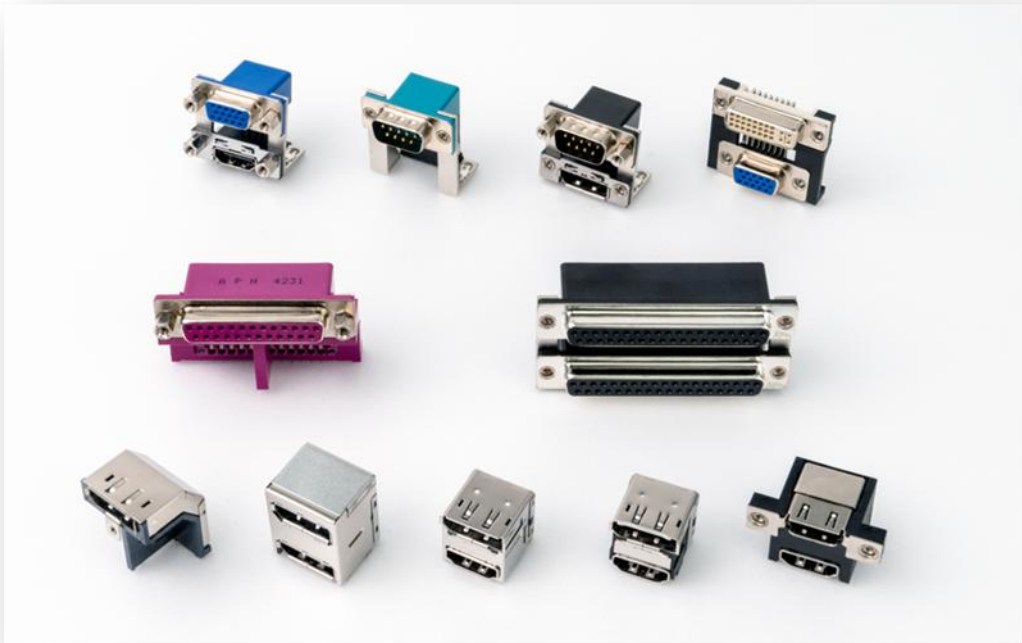

## Consumer connector Series

### TYPE C SERIES



## Communication connector Series

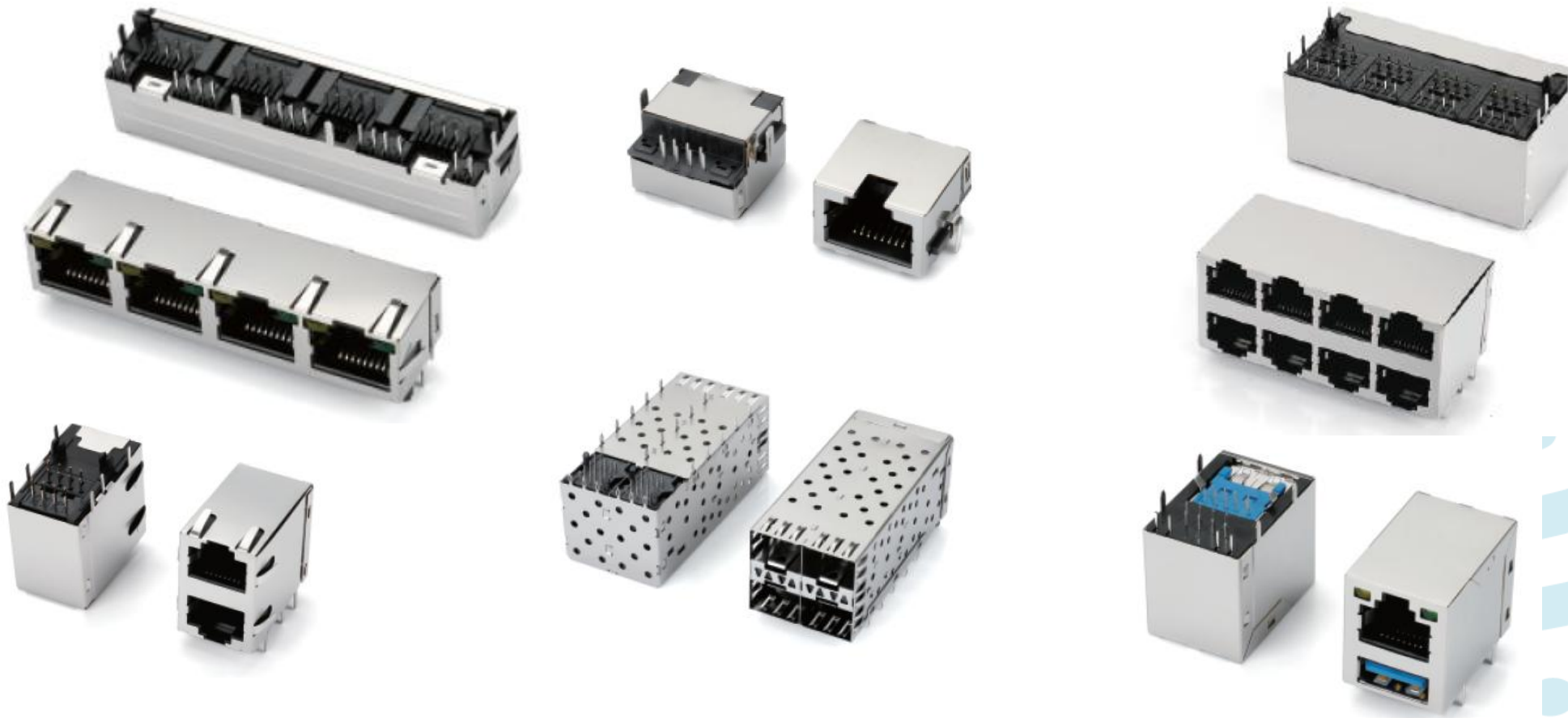

## Communication connector Series



# THANK YOU



范繼文 | 副總經理



唯城科技有限公司  
CYBERAPEX TECHNOLOGY CO., LTD.

統一編號:69266341

+886 922090866

mentobagel66

vanessafan2222

vanessa.fan@wway-tech.com

<https://cyberapex.en.taiwantrade.com/>

臺灣:新北市板橋區篤行路二段77巷12弄19號5樓

大陸:廣東省東莞市大嶺山鎮獅軍路136号光輝智谷4栋2樓



Deputy General Manager

Vanessa Fan



CYBERAPEX TECHNOLOGY CO., LTD.

+886 922090866

mentobagel66

vanessafan2222

vanessa.fan@wway-tech.com

<https://cyberapex.en.taiwantrade.com/>

Address(TW): 5F., No.19.Aly. 12.Ln 77, Sec. 2. Duxing Rd.Banqiao Dist., New Taipei City220 ,Taiwan(R.O.C.)

Address(CN):2th Floor, Building 4,Guanghui City,No.136 Yongjun Road, Dalingshan Town,Dongguan City,220 ,Guangdong Province