

Product catalogue 2025

Carutti.

In Cariitti's product range, you will find a comprehensive range of products for the lighting and decoration of saunas, spas, and various wellness facilities. Most recently, our collection has been supplemented with TAIVE saunas and ready-made cabins.

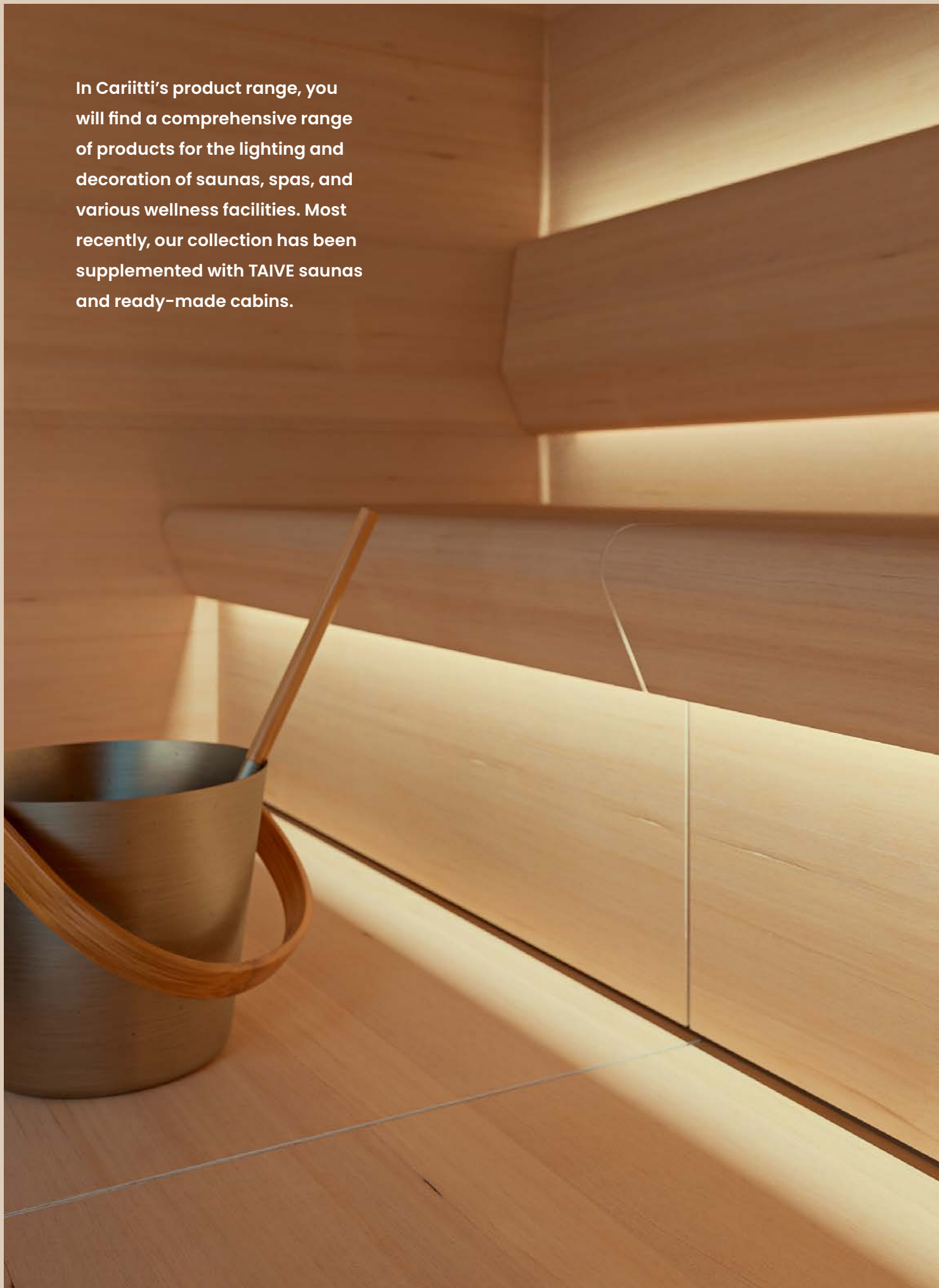

A vertical photograph on the left side of the page showing the interior of a wooden sauna. The walls and benches are made of light-colored wood, and a thin, glowing fiber optic cable is visible running vertically along the wall.

CONTENTS

Sauna bench lighting	20
Sauna ceiling lighting	29
Sauna lights and light fittings	40
Sauna LED lighting	53
TAIVE sauna	58
Starlight sets	70
Steam room lighting	82
Bathroom lighting	96
Pool lighting	102
Chandeliers and space dividers	108
LED profiles and indirect lighting	112
Projectors	118
Glass fiber harnesses	124
Optic fibers	129
Power supplies, control units, regulators	134



“Ancient Greek mythology had three goddesses of charm and beauty - Aglaea (brilliance), Euphrosyne (joy) and Thalia (abundance) - giving people joy and charm. They were also known as Charites or Graces.”

The story of Cariitti began at the end of the 1940s, in Kari Ruukonen's childhood. At a time when toys were scarce, little Kari was fascinated by a torch he had seen in a shop. How exciting it would be to explore the secrets of the shady woods and reveal them by the beam of the torch, or play with shadows in the dark cellar – and how the same torch could bring warmth and safety when needed. That torch cost 90 Finnish penni, a small fortune for a little boy. For more than two months, Kari saved his pocket money to fulfil his dream.

Later on, lighting became Kari's lifework. He was an entrepreneur in the lighting industry and ended up in Kirkkonummi, where he decided to buy a traditional lighting workshop "Valaisinpaja" with his family. Soon they wanted to change the company name to a more international one. As the starting point was Kari, the word Charite was found in Greek mythology and so it became CARIITTI.

These decades have been a time of change. The development of LED lighting has transformed the world, and lighting technology continues to break new territory. Throughout these times, Cariitti's mission – unique experiences in light – has remained unchanged.

When many other lighting manufacturers simply seek to increase the amount of light, Cariitti aims much higher. Our vision is to create light beautifully, stylishly and attractively. Cariitti continues to bring brilliance, joy and abundance to people's lives, just as the three Charites of the ancient Greeks.

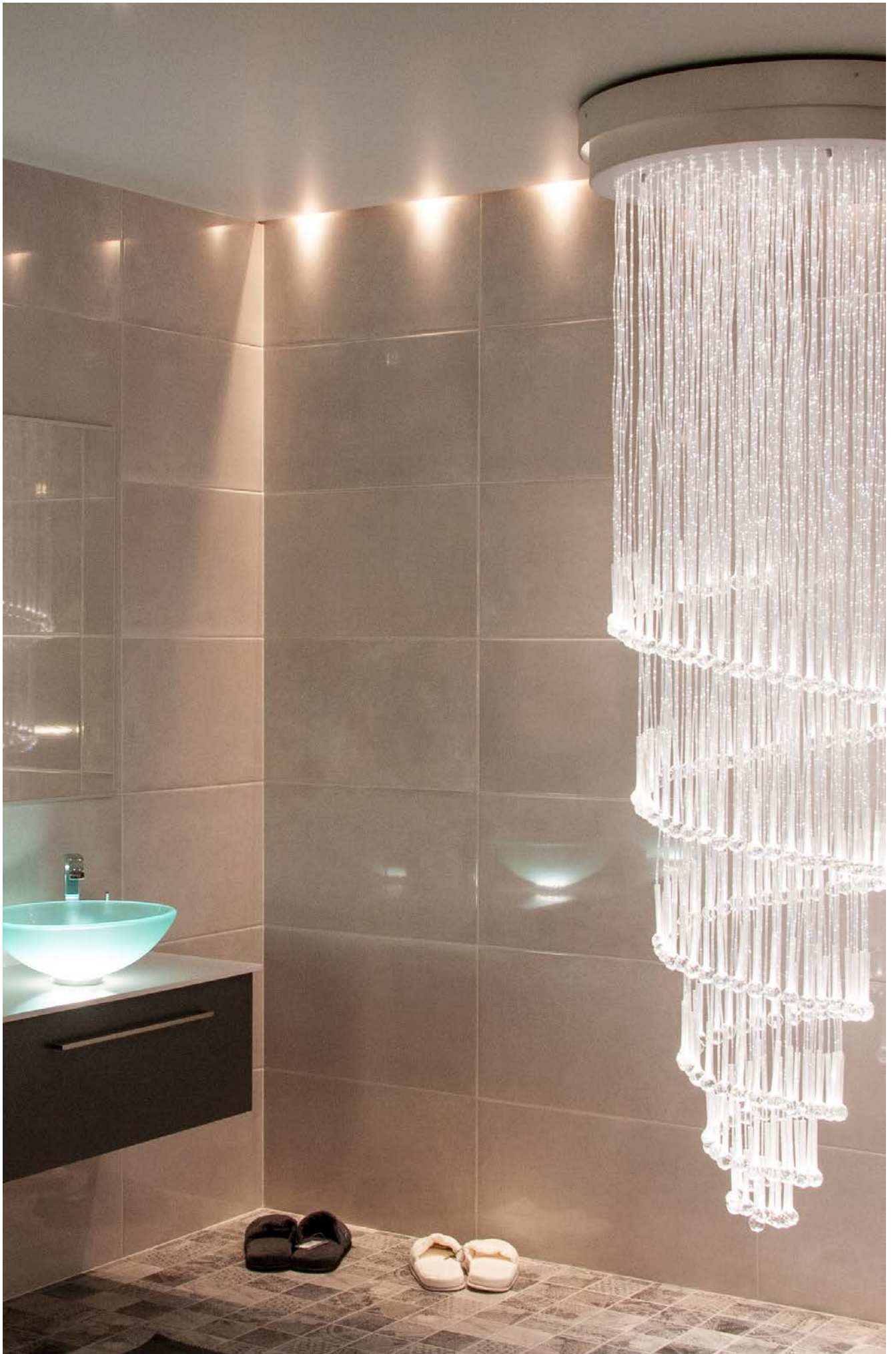

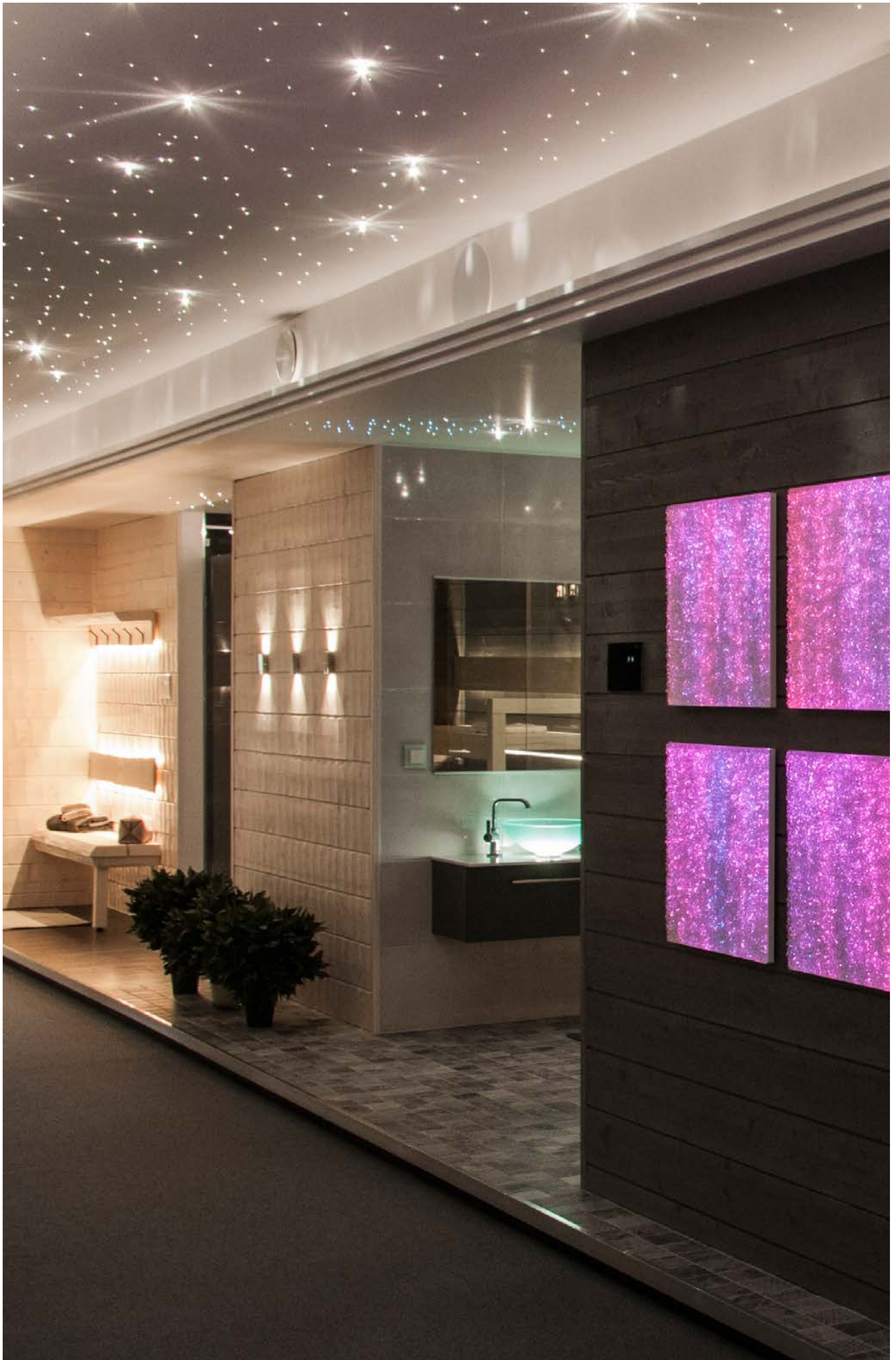



CARIITTI SHOWROOM

When you are building or renovating a house or searching new solutions for your interior design, you are welcome to our showroom. In our showroom you get familiarized with the wide selection of our lighting and sauna interior options. You can find practical solutions for illumination and interior design of saunas, steamrooms and bathrooms. At the same time you have a chance to familiarize with the latest wireless control techniques and voice control. Come and experience: "Alexa, turn on relax".



NEW PRODUCTS 2025

In 2025, Cariitti introduces new Eclipse products to complement the digital thermo-hygrometer Aspectu. The Eclipse wall lights in the sauna are backlit. Together, these create an impressive ensemble in the interior of the sauna.

We have also renewed our projector range. New high-performance LED components combined with intelligent control make the projector even better and more user-friendly. In addition, the popular Sauna Ultra Ambient product family now also includes TW and RGBW versions.

Our collection has also been supplemented with new Casambi, BLE (Bluetooth Low Energy) lighting control products, which can be applied to use with all Cariitti products.





A WELL-DESIGNED SAUNA IS A SPACE WHERE BOTH THE BODY AND MIND REST

To achieve a successful result, it is good to take into account the following points in the design, which make the sauna experience visual, practical and safe and that guarantee good functionality of the space.





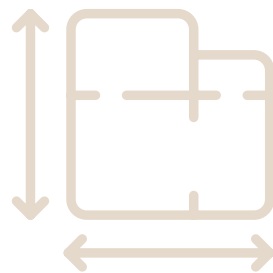

PERCEIVING THE SPACE

What is the size of the space, and what can be implemented in it? Straight single-wall bench, L-bench, II-benches or U-bench? What kind of lower bench is suitable for the space? Does it allow a larger lower bench level that is spacious, easy to access and safe at all stages of life?

Once the bench solution is ready, the lighting of the sauna can be designed. The lighting must be atmospheric but at the same time sufficient for safety. It is important to pay attention to the placement of lighting so that it emphasizes the bench structures and creates a pleasant whole. In addition, the luminaires must be able to withstand the temperature fluctuations and humidity of the sauna.

How is access to the benches illuminated? At this point, it is also good to think about the heater, what kind of model fits with the bench ensemble, and possible lighting of the heater. Illuminating the steam is a strong visual effect that adds the atmosphere of the sauna.

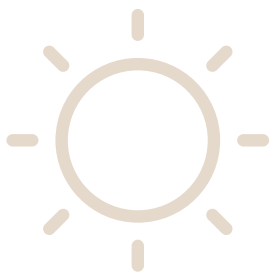

SAUNA LIGHTING

Once the bench assembly has been decided, you can focus on choosing the sauna lighting. Do you want to bring light from the ceiling with optical fibers or do you want indirect linear light, for example behind the backrest and under the upper bench?

Often, a stove light fiber is installed on the ceiling above the heater. It illuminates the heater in a nice way, and it also serves as a visual effect. When choosing the lighting, you must also take into account the electrical safety regulations, and make sure that the luminaires are suitable for installation in a sauna.



TAIVE® sauna





FIBER OPTIC LIGHTING

Sauna fiber lighting sets are equipped with LED projectors and they guarantee low energy consumption and a very long service life. LED projectors are completely silent and they generate only a small amount of heat and they are specially designed for sauna lighting.

When installing the lighting, the optical fibers are routed behind the panels. It is good to take the fibers close to the final lighting point. If necessary, the fiber can be attached to the aluminium foil with aluminium tape, waiting for the final installation on the panel. When panelling, you should be careful that the fibers do not get compressed between the panels or the joints, that they do not get sharp 90-degree bends, and that they do not get hit by nails when attaching the panels. Many different sauna light fittings from Cariitti's selection can be combined with the fiber optic sets.





SAUNA LINEAR LED

With **Sauna Linear LED**, you can get even light behind the backrest and under the upper bench, giving airiness and a sense of space to the sauna. Sauna Linear LEDs are available in three different lengths and they can be easily shortened to a suitable size during the installation.

When installing Sauna Linear LED, the silicone cables of the LED heads are taken behind the panels to the driver (IP55), which is installed under the sauna benches.



TAIVE® sauna



TAIVE® sauna



LED LIGHTING / SAUNA ULTRA AMBIENT

With **Sauna Ultra Ambient** LED strip you can illuminate even the most demanding objects. Sauna Ultra Ambient is designed for very demanding locations with an ambient temperature of $-40\dots+125$ °C. The product is designed to tolerate the stress caused by large temperature fluctuations and it has excellent durability at high ambient temperatures.

With Sauna Ultra Ambient you create beautiful indirect lighting also on the ceiling of the sauna. There are two product options, side and top lighting versions. The flexible strip is very easy to install.



SAUNA LIGHTING

With **the choice of materials**, you can influence the atmosphere and lighting. When planning the lighting of the sauna, it is good to consider the colors of the benches and panels. Dark surfaces always require more light than light ones. A good guideline for sauna lighting is to illuminate the sauna, not sauna-bathers. This should be taken into account when designing the lighting points.

The gentle and pleasant style of the sauna is easy to carry on to the bathroom side with Cariitti's LED lights. The interior is finished with compatible TAIVE ceiling panels and indirect tunable white light. With tunable lighting you can adjust the light color temperature and easily change from one mood to another.



Lighting the sauna and bathroom with pleasant indirect lighting.



The sauna is illuminated with Sauna Linear lights both behind the backrest and under the bench.



SAUNA BENCH LIGHTING

With Sauna Linear products, you can implement indirect lighting for the benches.

With optic glass fiber sets, you can get beautifully illuminated light beams behind the backrest and on the front edge of the upper bench. The fiber optic sets have an LED projector for humid conditions and it can be installed in the sauna room under the bench.



SAUNA LINEAR LED

With Sauna Linear products you will get an even light behind the backrest or under the front edge of the upper bench.



SAUNA LINEAR LED 1M

Code: 1816032

- 1 meter linear bar
- 2 pcs LED light sources
- 2700 K
- Cable length 2,5 m
- Power supply, suitable for a sauna (non-dimmable) IP55
- Ta 125°



SAUNA LINEAR LED 2M

Code: 1816033

- 2 m linear bar
- 2 pcs LED light sources
- 2700 K
- Cable length 2,5 m
- Power supply, suitable for a sauna (non-dimmable) IP55
- Ta 125°



SAUNA LINEAR LED 3M

Code: 1816034

- 2 pcs 1,5 m linear bars
- 3 pcs LED light sources
- 2700 K
- Cable length 2,5 m
- Power supply, suitable for a sauna (dimmable) IP55
- Ta 125°

PRODUCT INFORMATION

The power supply of the **Sauna Linear set** has a protection rate IP55. The power supply can be placed inside the sauna, under the bench, max. installation height 80 cm from the floor. The light sources have 1 W LEDs. The max. installation height of the linear bar and LED light sources is 1.5 m from the floor. Color temperature 2700 K. The linear bar is illuminated from both ends and the

bar can be shortened on site, e.g. with a circular saw. The light bar is not all-illuminating. During the installation, the light can be focused to the desired direction by directing the bar. The set is also easy to install in a ready-made sauna. The power supply and LED light sources are suitable for surface mounting. You can add one more LED light source to this set, e.g. with a fiber for the stove light.

SAUNA LINEAR WITH A STOVE LIGHT FIBER

Cariitti's ready-made sauna lighting sets are made for you who want an even and smooth light in the sauna. With the stove light fiber, included in the sets, you can illuminate the heater.



SAUNA LINEAR 4M LED + SPOT

Code: 1816035

- 2 pcs 2 meter linear bars
- 1 pcs LED stove light glass fiber 5.0 m with a lens
- 4 pcs LED light sources for the bar ends, length of the cables 2,5 m
- 2700 K
- Power supply, suitable for a sauna (dimmable) IP55
Dimming with trailing edge dimmer (TE)
- Ta 125°



SAUNA LINEAR 6M LED + SPOT

Code: 1816036

- 4 pcs 1,5 meter linear bars
- 1 pcs LED stove light glass fiber 5.0 m with a lens
- 6 pcs LED light sources for the bar ends, length of the cables 2,5 m
- 2700 K
- Power supply, suitable for a sauna (dimmable) IP55
Dimming with trailing edge dimmer (TE)
- Ta 125°

PRODUCT INFORMATION

The power supply of the **Sauna Linear set** has a protection rate IP55. The power supply can be placed inside the sauna, under the bench, max. installation height 80 cm from the floor. The light sources have 1 W LEDs. The max. installation height of the linear bar and LED light sources is 1.5 m from the floor. Color temperature 2700 K. The linear bar is illuminated from both ends and the

bar can be shortened on site, e.g. with a circular saw. The light bar is not all-illuminating. During the installation, the light can be focused to the desired direction by directing the bar. The set is also easy to install in a ready-made sauna. The power supply and LED light sources are suitable for surface mounting. These sets include a stove light fiber with a lens.

SAUNA LIGHTING ECO SETS

These sets are very well suited for lighting small saunas.

The fibers of the sets are suitable for installation on both benches and ceilings.



SAUNA LIGHTING ECO 6

Code: 1816038

- Non-dimmable
- 230V / 1 W / 350 mA
- 2700 K / Ra >85
- Protection rating IP55 of the projector
- Dimensions of the projector: Ø 30 mm, length 80 mm, mounting box 130 x 85 mm
- Stove lens included
- Fiber lengths: S-Flex 1.5 (B1,5) 5 x 2.5 m and S-Flex 2 (M5) 1 x 4.5 m



SAUNA LIGHTING ECO 16

Code: 1816037

- Non-dimmable
- 230V / 1 W / 350 mA
- 2700 K / Ra >85
- Protection rating IP55 of the projector
- Dimensions of the projector: Ø 30 mm, length 80 mm, mounting box 130 x 85 mm
- Stove lens included
- Fiber lengths: S-Flex 1.5 (B1,5) 5 x 1.5 m, 6 x 2.0 m and 5 x 2.5 m

PRODUCT INFORMATION

The sauna lighting set with a 1 W LED projector ensures low energy consumption and a very long lifetime. Completely silent, low-heat LED projectors are specially designed for sauna lighting. This set is suitable for lighting a small sauna of approx. 2 m².

The fibers of the set are made of glass and they can tolerate 180°C heat. The fibers are suitable for installation on both benches and ceilings. Projector mounting height max. 80 cm from the floor. N.B! The fiber must not be cut!

SAUNA LIGHTING ECO+ SETS

The fibers of the sets are suitable for installation on both benches and ceilings.



SAUNA LIGHTING ECO+ 6

Code: 1816040

- LED 2,1 W
- 220-240 V AC / 700 mA DC
- 50 000 h
- 2700 K
- Ra >90
- 136 lm
- Dimensions of the projector: 100 x 150 x 80 mm
- Fiber lengths: S-Flex 1,5 (B1,5) 5 x 2,5 m and S-Flex 2 (M5) 1 x 4,5 m
- Non-dimmable
- Stove lens included



SAUNA LIGHTING ECO+ 8

Code: 1816042

- LED 2,1 W
- 220-240 V AC / 700 mA DC
- 50 000 h
- 2700 K
- Ra >90
- 136 lm
- Dimensions of the projector: 100 x 150 x 80 mm
- Fiber lengths: S-Flex 1,5 (B1,5) 2 x 2,5 m, 2 x 3,0 m, 2 x 3,5 m and 2 x 4,0 m
- Non-dimmable
- Stove lens included



SAUNA LIGHTING ECO+ 9

Code: 1816041

- LED 2,1 W
- 220-240 V AC / 700 mA DC
- 50 000 h
- 2700 K
- Ra >90
- 136 lm
- Dimensions of the projector: 100 x 150 x 80 mm
- Fiber lengths: S-Flex 1,5 (B1,5) 3 x 2,0 m, 3 x 2,5 m and 3 x 3,0 m
- Non-dimmable
- Stove lens included



SAUNA LIGHTING ECO+ 16

Code: 1816039

- LED 2,1 W
- 220-240 V AC / 700 mA DC
- 50 000 h
- 2700 K
- Ra >90
- 136 lm
- Dimensions of the projector: 100 x 150 x 80 mm
- Fiber lengths: S-Flex 1,5 (B1,5) 5 x 1,5 m, 6 x 2,0 m and 5 x 2,5 m
- Non-dimmable
- Stove lens included

PRODUCT INFORMATION

These sets include a projector (IP65), placed under the sauna bench, a glass fiber harness and a stove lens. Glass fibers tolerate 180°C heat.

The fibers of the sets are suitable for installation on both benches and ceilings.

Projector mounting height max. 80 cm from the floor.

N.B! The fiber must not be cut!

In addition to standard fiber sets, we also manufacture fiber sets with special dimensions on request.



SAUNA BENCH LIGHTING PRO SETS

These sets are very well suited for lighting small and medium-sized saunas.

The projectors of the PRO sets are dimmable.



SAUNA BENCH LIGHTING PRO 11

Code: 1516708

- 230 V, 16 W
- 50 000 h
- 2700 K / Ra >90
- Dimensions of the projector: L 145 x W 150 x H 83, weight 1,03 kg
- Mains dimmable
- Fiber lengths:
 - Ø 2 mm (B2) 4 x 1,4 m / 4 x 1,7 m / 2 x 2,0 m
 - Ø 4 mm (M8) 1 x 4,0 m (stove light fiber)



SAUNA BENCH LIGHTING PRO 17

Code: 1516709

- 230 V, 16 W LED
- 50 000 h
- 2700 K / Ra >90
- Dimensions of the projector: L 145 x W 150 x H 83, weight 1,03 kg
- Mains dimmable
- Fiber lengths:
 - Ø 2 mm (B2) 4 x 1,4 m / 4 x 1,7 m / 4 x 2,0 m / 2 x 2,3 m / 2 x 2,6 m
 - Ø 4 mm (M8) 1 x 4,0 m (stove light fiber)



SAUNA BENCH LIGHTING PRO 23

Code: 1516710

- 230 V, 16 W LED
- 50 000 h
- 2700 K / Ra >90
- Dimensions of the projector: L 145 x W 150 x H 83, weight 1,03 kg
- Mains dimmable
- Fiber lengths:
 - Ø 2 mm (B2) 4 x 1,4 m / 4 x 1,7 m / 4 x 2,0 m / 4 x 2,3 m / 2 x 2,6 m / 2 x 2,9 m / 2 x 3,2 m
 - Ø 4 mm (M8) 1 x 4,0 m (and stove light fiber)



SAUNA BENCH LIGHTING PRO 29

Code: 1516711

- 230 V, 16 W LED
- 50 000 h
- 2700 K / Ra >90
- Dimensions of the projector: L 145 x W 150 x H 83, weight 1,03 kg
- Mains dimmable
- Fiber lengths:
 - Ø 2 mm (B2) 4 x 1,4 m / 4 x 1,7 m / 4 x 2,0 m / 4 x 2,3 m / 4 x 2,6 m / 2 x 2,9 m / 2 x 3,2 m / 2 x 3,5 m / 2 x 3,8 m
 - Ø 4 mm (M8) 1 x 4,0 m (stove light fiber)

PRODUCT INFORMATION

In the selection of Sauna Bench Sets, you will find a suitable option for lighting small, medium and large saunas. The fibers in these sets are made of glass and they can tolerate 180°C heat. The fibers are suitable for installation on both benches and ceilings.

Projector mounting height max. 80 cm from the floor. The sets include a projector, a fiber glass harness and a stove light lens. N.B! The fiber must not be cut!

In addition to standard fiber sets, we also manufacture fiber sets with special dimensions on request.

SAUNA LIGHTING COLOR SETS

These sets are very well suited for lighting small and medium-sized saunas. The projectors in the color sets are equipped with a color-changing RGBW LED. Control and dimming with the included wireless switch.



SAUNA LIGHTING COLOR 11

Code: 1816001

- 230 V, 10 W, mains voltage LED
- 60 000 h
- RGB + W 7600 K
- Dimensions of the projector: L 145 x W 150 x H 83, weight 1,03 kg
- Fiber lengths:
 - Ø 2 mm (B2) 4 x 1,4 m / 4 x 1,7 m / 2 x 2,0 m
 - Ø 4 mm (M8) 1 x 4,0 m (stove light fiber)



SAUNA LIGHTING COLOR 17

Code: 1816002

- 230 V, 10 W LED
- 60 000 h
- RGB + W 7600 K
- Dimensions of the projector: L 145 x W 150 x H 83, weight 1,03 kg
- Fiber lengths:
 - Ø 2 mm (B2) 4 x 1,4 m / 4 x 1,7 m / 4 x 2,0 m / 2 x 2,3 m / 2 x 2,6 m
 - Ø 4 mm (M8) 1 x 4,0 m (stove light fiber)



SAUNA LIGHTING COLOR 23

Code: 1816003

- 230 V, 10 W LED
- 60 000 h
- RGB + W 7600 K
- Dimensions of the projector: L 145 x W 150 x H 83, weight 1,03 kg
- Fiber lengths:
 - Ø 2 mm (B2) 4 x 1,4 m / 4 x 1,7 m / 4 x 2,0 m / 4 x 2,3 m / 2 x 2,6 m / 2 x 2,9 m / 2 x 3,2 m
 - Ø 4 mm (M8) 1 x 4,0 m (stove light fiber)



SAUNA LIGHTING COLOR 29

Code: 1816004

- 230 V, 10 W LED
- 60 000 h
- RGB + W 7600 K
- Dimensions of the projector: L 145 x W 150 x H 83, weight 1,03 kg
- Fiber lengths:
 - Ø 2 mm (B2) 4 x 1,4 m / 4 x 1,7 m / 4 x 2,0 m / 4 x 2,3 m / 4 x 2,6 m / 2 x 2,9 m / 2 x 3,2 m / 2 x 3,5 m / 2 x 3,8 m
 - Ø 4 mm (M8) 1 x 4,0 m (stove light fiber)

PRODUCT INFORMATION

The sets have an RGBW-BLE projector with LED color change. For controlling the color change there is a control switch, which is connected to the projector wirelessly. The control switch is completely wireless and it has no batteries. The control can be extended with the Casambi App for smartphones. The App can be downloaded in the App Store and Google Play.

The fibers in the sets are suitable for installation on both benches and ceilings. Projector mounting height max. 80 cm from the floor. N.B! The fiber must not be cut!
In addition to standard fiber sets, we also manufacture fiber sets with special dimensions on request.

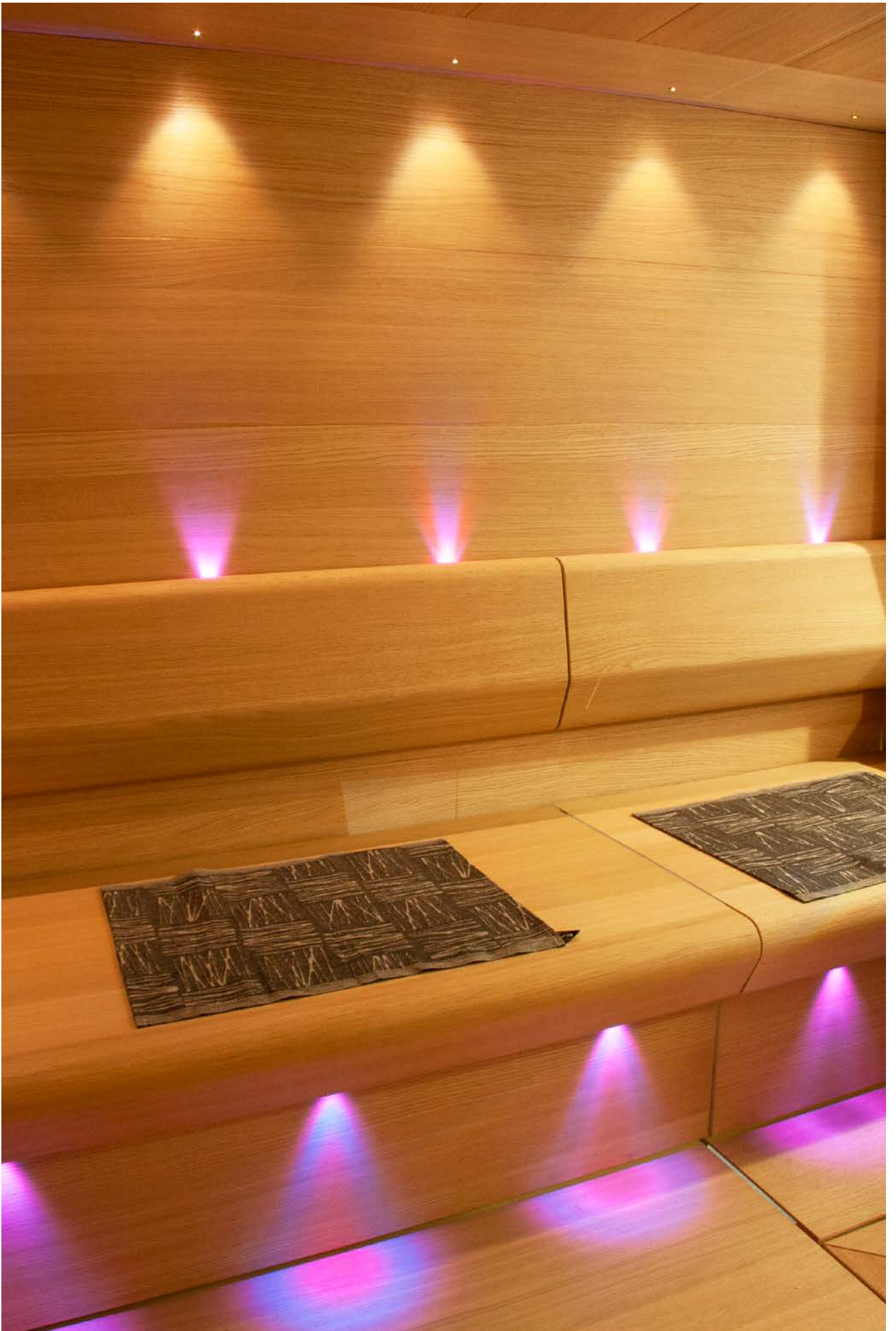

NORTHERN LIGHTS BENCH LIGHTING SET

The Northern Lights set is designed to be installed in the sauna, behind the backrest. The set has projector VPL30 NL with an LED-based northern lights effect that changes colors blue, green and magenta.



NORTHERN LIGHTS 2M BENCH LIGHTING SET

Code: 1516620

- VPL30 NL projector. Dimensions: L 250 x W 150 x H 83, weight 2,5 kg
- N2M fiber set, (C-Flex 7 plastic fiber 1 x 1.2 + 1 meter linear bar and 1 x 2.2 m + 1 meter linear bar)



NORTHERN LIGHTS 4M BENCH LIGHTING SET

Code: 1516621

- VPL30 NL projector. Dimensions: L 250 x W 150 x H 83, weight 2,5 kg
- N4M fiber set (C-Flex 7 plastic fiber 2 x 1.2 m + 1 meter linear bar and 2 x 2.2 m + 1 meter linear bar)

PRODUCT INFORMATION

The set is easy to install even as a retrofit to a ready-made sauna. The installation height of the projector in the sauna is max. 80 cm from the floor.

N.B! The fiber must not be cut!

In addition to standard fiber sets, we also manufacture fiber sets with special dimensions on request.



SAUNA CEILING LIGHTING

Cariitti has the widest selection of sauna lights on the market, which includes not only sets for ceiling lighting, but also various light fittings suitable for saunas. With Cariitti fiber optic lighting, you can illuminate the sauna imaginatively, without limits.

The completely silent, dimmable LED projectors are specially designed for sauna lighting. You can combine fibers with all sauna light fittings from our selection.

With the Ultra Ambient LED strip, you can illuminate even the most demanding objects.

With Ultra Ambient, you can also create beautiful indirect lighting on the ceiling of the sauna.

SAUNA ULTRA AMBIENT

The product has been designed to overcome the stresses caused by large temperature fluctuations and excellent resistance to high ambient temperatures.



SAUNA ULTRA AMBIENT 2M SIDE

Code: 1832157

- White 2700 K, 3 W/m, 24 V
- 50 lm/m, 16,7 lm/W
- Ambient temperature T_a $-40^{\circ}\text{C} \dots +125^{\circ}\text{C}$
- Ra 90
- Cut-off interval 50 mm
- Minimum bending radius 30 mm
- L 2000 mm x H 12 mm x W 6 mm
- Length of connecting wire 5 m
- Cable outer material: silicone
- Maximum cable temperature resistance $+200^{\circ}\text{C}$
- Silicone shell temperature resistance $+180^{\circ}\text{C}$
- Silicone characteristic: non-yellowing
- Dimmable with the extension unit 1832177
- IP67



SAUNA ULTRA AMBIENT 2M TOP

Code: 1832152

- White 2700 K, 3 W/m, 24 V
- 160 lm/m, 53 lm/W
- Ambient temperature T_a $-40^{\circ}\text{C} \dots +125^{\circ}\text{C}$
- Ra 90
- Cut-off interval 50 mm
- Minimum bending radius 30 mm
- L 2000 mm x H 10 mm x W 10 mm
- Length of connecting wire 5 m
- Cable outer material: silicone
- Maximum cable temperature resistance $+200^{\circ}\text{C}$
- Silicone shell temperature resistance $+180^{\circ}\text{C}$
- Silicone characteristic: non-yellowing
- Dimmable with the extension unit 1832177
- IP67



SAUNA ULTRA AMBIENT 6M SIDE

Code: 1832155

- White 2700 K, 3 W/m, 24 V
- 50 lm/m, 16,7 lm/W
- Ambient temperature T_a $-40^{\circ}\text{C} \dots +125^{\circ}\text{C}$
- Ra 90
- Cut-off interval 50 mm
- Minimum bending radius 30 mm
- L 6000 mm x H 12 mm x W 6 mm
- Length of connecting wires 5 m
- Cable outer material: silicone
- Maximum cable temperature resistance $+200^{\circ}\text{C}$
- Silicone shell temperature resistance $+180^{\circ}\text{C}$
- Silicone characteristic: non-yellowing
- Dimmable with the extension unit 1832177
- IP67



SAUNA ULTRA AMBIENT 6M TOP

Code: 1832150

- White 2700 K, 3 W/m, 24 V
- 160 lm/m, 53 lm/W
- Ambient temperature T_a $-40^{\circ}\text{C} \dots +125^{\circ}\text{C}$
- Ra 90
- Cut-off interval 50 mm
- Minimum bending radius 30 mm
- L 6000 mm x H 10 mm x W 10 mm
- Length of connecting wires 5 m
- Cable outer material: silicone
- Maximum cable temperature resistance $+200^{\circ}\text{C}$
- Silicone shell temperature resistance $+180^{\circ}\text{C}$
- Silicone characteristic: non-yellowing
- Dimmable with the extension unit 1832177
- IP67



PRODUCT INFORMATION

With the **Sauna Ultra Ambient LED strip**, you can illuminate even the most challenging objects. Ultra Ambient is designed for very demanding applications, with ambient temperature of $-40^{\circ}\text{C} \dots +125^{\circ}\text{C}$. The product has been designed to endure the stresses caused by large temperature fluctuations, and to guarantee excellent durability at high ambient temperatures. With Ultra Ambient you can create beautiful indirect lighting also on the ceiling of the sauna. There are two product options, side and top illuminating versions. Flexible LED strips are very easy to install. The product is supplied as a ready-to-install kit. The LED strip can be cut and finished to the desired length, cutting interval 50 mm. Ultra Ambient is implemented also in backlighting of Aspectu and Eclipse products. Also available dimmable. In addition to ready-made sets we also manufacture sets with special dimensions to order.

The 2M Side/Top set includes: 2 meter LED strip with fixed 5 meter wire, 1 pc end cap for the supply cable, 1 pc end cap, 8 pcs clips with screws, silicone glue and constant voltage power supply (max 36 W) in IP55 housing (non-dimmable).

The 6M Side set includes: 6 meter LED strip with fixed 5 meter wires at both ends, 2 pcs end caps for the supply cable, 2 pcs end caps, 24 pcs clips with screws, silicone glue and constant voltage power supply (max 36 W) in IP55 housing (non-dimmable).

Dimming with an extension unit:

OTi DALI DIM 1-4CH D, 1832177

Dimming with an alternative power supply:

TRIAC constant voltage driver OT FIT 36/220-240/24 PC, 1863036

TRIAC constant voltage driver OT FIT 75/220-240/24 PC, 1863037

Casambi constant voltage driver OT WI 50/220-240/24 4CH, 1832176

Casambi constant voltage driver OT WI 80/220-240/24 4CH, 1532137

SAUNA ULTRA AMBIENT

With the Ultra Ambient tunable white LED strip 2200-4000 K, you can illuminate even the most demanding objects.



SAUNA ULTRA AMBIENT TW SIDE

Code: 1898061

- White 2200 - 4000 K, 3 W/m, 24 V
- 50 lm/m, 16,7 lm/W
- Ambient temperature Ta -40°C... +125 °C
- Ra 90
- Cut-off interval 50 mm
- Minimum bending radius 30 mm
- H 12 mm x W 6 mm
- Cable outer material: silicone
- Maximum cable temperature resistance +200 °C
- Silicone shell temperature resistance +180 °C
- Silicone characteristic: non-yellowing
- IP67

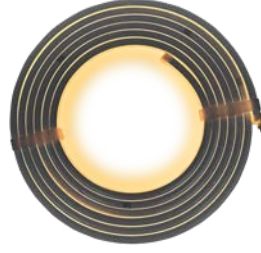

SAUNA ULTRA AMBIENT TW TOP

Code: 1898062

- White 2200 - 4000 K, 3 W/m, 24 V
- 160 lm/m, 53 lm/W
- Ambient temperature Ta -40°C... +125 °C
- Ra 90
- Cut-off interval 50 mm
- Minimum bending radius 30 mm
- H 10 mm x W 10 mm
- Cable outer material: silicone
- Maximum cable temperature resistance +200 °C
- Silicone shell temperature resistance +180 °C
- Silicone characteristic: non-yellowing
- IP67

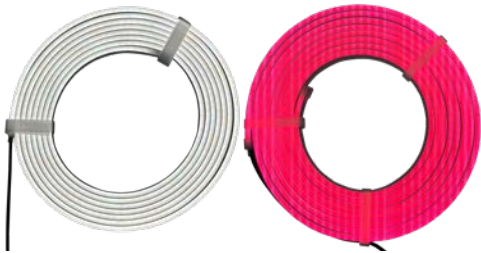

SAUNA ULTRA AMBIENT RGBW SIDE

Code: 1898063

- RGBW SIDE, 3 W/color/m, 24 V
- Ambient temperature Ta -40°C... +125 °C
- Ra 90
- Cut-off interval 50 mm
- Minimum bending radius 30 mm
- H 12 mm x W 6 mm
- Cable outer material: silicone
- Maximum cable temperature resistance +200 °C
- Silicone shell temperature resistance +180 °C
- Silicone characteristic: non-yellowing
- IP67

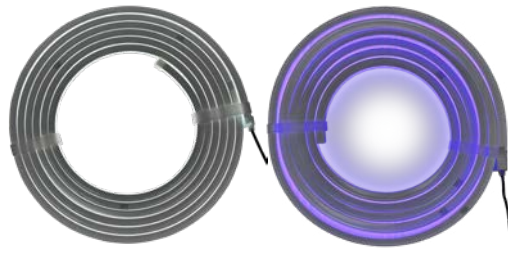

SAUNA ULTRA AMBIENT RGBW TOP

Code: 1898064

- RGBW TOP, 3 W/color/m, 24 V
- Ambient temperature Ta -40°C... +125 °C
- Ra 90
- Cut-off interval 50 mm
- Minimum bending radius 50 mm
- H 14 mm x W 14 mm
- Cable outer material: silicone
- Maximum cable temperature resistance +200 °C
- Silicone shell temperature resistance +180 °C
- Silicone characteristic: non-yellowing
- IP67



MOUNTING CLIPS

Code:

- 1532491 Mounting clip for SIDE emitting LED strip 6 x 12 mm
- 1898053 Mounting clip for TOP emitting LED strip 10 x 10 mm
- 1898056 Mounting clip for TOP emitting LED strip 14 x 14 mm

Attached to the base with a screw, press the LED strip to the clip.



MOUNTING PROFILE for SIDE emitting LED strip

Code: 1898043

- The mounting profile, length 1 m, is attached with screws to the base and the LED strip is pressed into the profile.



FLEXIBLE MOUNTING PROFILE for SIDE emitting LED strip

Code: 1898045

- The flexible mounting profile, length 1 m, is attached with screws to the base and the LED strip is pressed into the profile.

SILICON END CAPS

Code:

- 1532492 End cap for SIDE emitting LED strip 6 x 12 mm
- 1898051 End cap for TOP emitting LED strip 10 x 10 mm
- 1898054 End cap for TOP emitting LED strip 14 x 14 mm
- 1532493 Straight feed cap for SIDE emitting LED strip 6 x 12 mm
- 1898052 Straight feed cap for TOP emitting LED strip 10 x 10 mm
- 1898055 Straight feed cap for TOP emitting LED strip 14 x 14 mm
- 1898073 Feed 90 cap for SIDE emitting LED strip 6 x 12 mm
- 1898071 Feed 90 cap for TOP emitting LED strip 10 x 10 mm
- 1898072 Feed 90 cap for TOP emitting LED strip 14 x 14 mm



MOUNTING PROFILE for TOP emitting LED strip

Code: 1898042

- The mounting profile, length 1 m, is attached with screws to the base and the LED strip is pressed into the profile.



FLEXIBLE MOUNTING PROFILE for TOP emitting LED strip

Code: 1898044

- The flexible mounting profile, length 1 m, is attached with screws to the base and the LED strip is pressed into the profile.

PRODUCT INFORMATION

With the Ultra Ambient TW and RGBW LED strip you can illuminate even the most challenging objects, either with tunable white light 2200-4000 K or with color change.

Ultra Ambient is designed for very demanding applications, with ambient temperature of -40°C...+125°C. The product has been designed to endure the stresses caused by large temperature fluctuations, and to guarantee excellent durability at high ambient temperatures. With Ultra Ambient you can create beautiful indirect lighting also on the ceiling of the sauna. There are two product options, side and top emitting versions. Flexible LED strips are very easy to install.

Delivered in full 10 m rolls or made to the ordered length. The strip can be cut and terminated to the desired length, cut-off interval 50 mm, dimmable.

Mounting Accessories:

In the Ultra Ambient product family, you will also find all the necessary mounting parts: end caps, mounting clips and profiles. With clips and profiles, you can complete even the most demanding installation.

Control and dimming with an extension unit:

OTI DALI DIM 1-4CH D, 1832177

Control and dimming with an alternative power supply:
Casambi constant voltage driver OT WI 50/220-240/24 4CH, 1832176

Casambi constant voltage driver OT WI 80/220-240/24 4CH, 1532137

SAUNA CEILING LIGHTING PRO SETS

Sauna lighting sets with 8, 11 or 21 fibers.

These sets are suitable for lighting medium-sized and large saunas.



SAUNA CEILING LIGHTING PRO 8

Code: 1516704

- 230 V, 16 W
- 50 000 h
- 2700 K
- Ra 90
- Dimensions of the projector:
L 145 x W 150 x H 83, weight 1,03 kg
- Fiber lengths:
Ø 2 mm (M5) 2 x 2,5 m / 3 x 3,0 m / 2 x 3,5 m
- Ø 3 mm (M5) 1 x 3,5 m (stove light fiber)
- Mains dimmable

SAUNA CEILING LIGHTING PRO 11

Code: 1516705

- 2230 V, 16 W
- 50 000 h
- 2700 K
- Ra 90
- Dimensions of the projector:
L 145 x W 150 x H 83, weight 1,03 kg
- Fiber lengths:
Ø 2 mm (M5) 5 x 3,5 m / 5 x 4,0 m
- Ø 4 mm (M8) 1 x 3,5 m (stove light fiber)
- Mains dimmable

SAUNA CEILING LIGHTING PRO 21

Code: 1516707

- 230 V, 16 W
- 50 000 h
- 2700 K
- Ra 90
- Dimensions of the projector:
L 145 x W 150 x H 83, weight 1,03 kg
- Fiber lengths:
Ø 2 mm (M5) 5 x 3,5 m / 5 x 4,0 m /
5 x 4,5 m / 5 x 5,0 m
- Ø 4 mm (M8) 1 x 3,5 m (stove light fiber)
- Mains dimmable

PRODUCT INFORMATION

8-fiber sauna lighting set, fiber lengths 2.5–3.5 m. This set is suitable for lighting small and medium-sized saunas. The recommended size of the sauna is 3–5 m².

11-fiber sauna lighting set, fiber lengths 3.5–4 m. This series is well suited for lighting medium-sized saunas. The recommended size of the sauna is 4–6 m².

21-fiber sauna lighting set, fiber lengths 3.5–5 m. This series is suitable for lighting large saunas. The recommended size of the sauna is 5–10 m².

These sets include an LED projector, fiber harness, locking rings and a stove lens.

Projector VPAC27 has IP65 protection rating and it can be placed under the benches. Mains dimmable.
The projector's max. installation height from the floor is 80 cm.

The fibers are made of glass and they can tolerate 180 °C heat. They can be installed on the ceiling of the sauna.

In addition to standard fiber sets, we also manufacture fiber sets with special dimensions on request.

N.B! The fibers must not be cut.

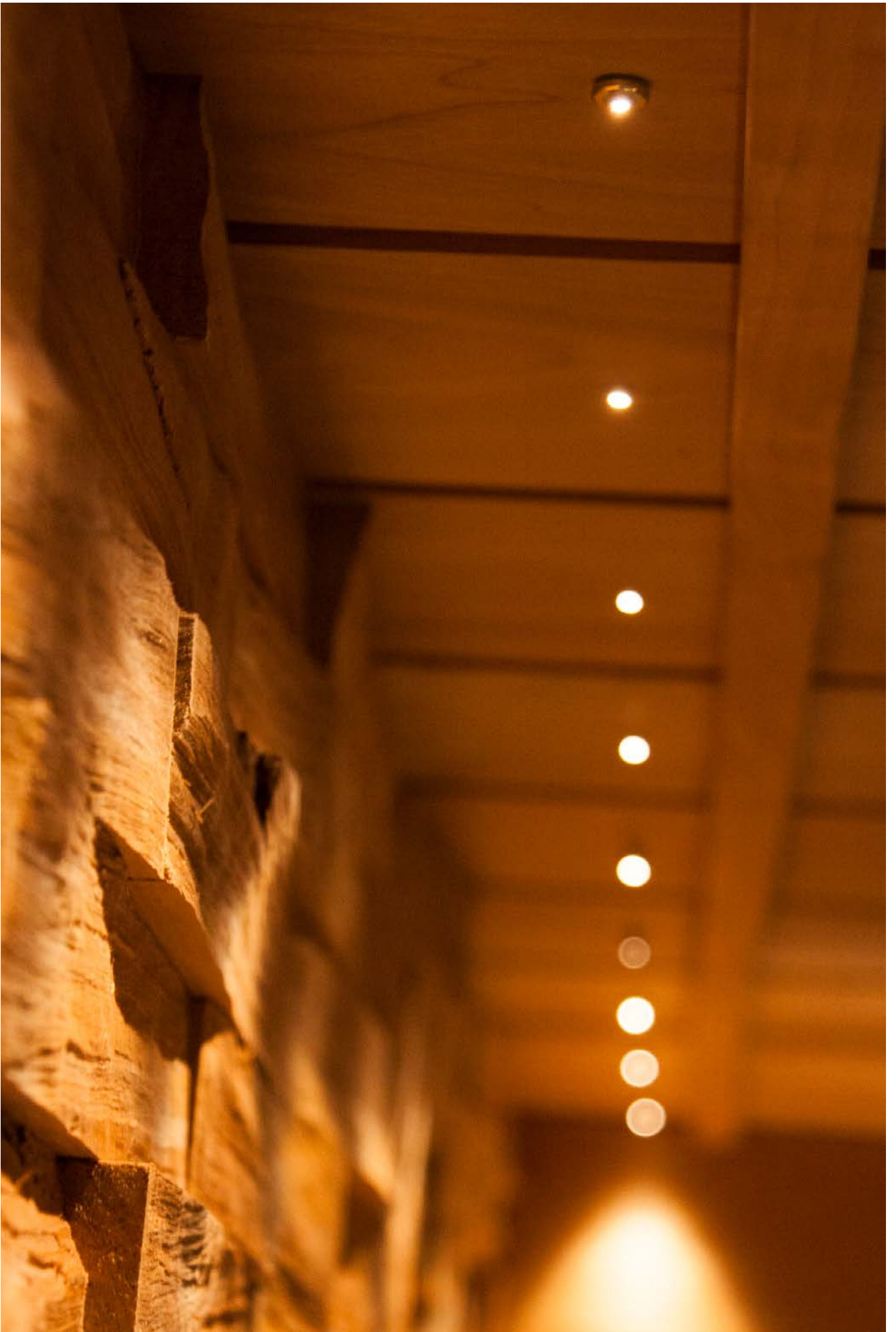

SAUNA CEILING LIGHTING PRO+ SETS

7-fiber sauna lighting sets, fiber lengths 2–4 m.

These sets have thicker 3 mm fibers and they are well suited for lighting medium-sized and large saunas.



SAUNA CEILING LIGHTING PRO+ 7 (2–3 m)

Code: 1516701

- 230 V, 16 W
- 50 000 h
- 2700 K
- Ra 90
- Dimensions of the projector: L 145 x W 150 x H 83, weight 1,03 kg
- Fiber lengths: Ø 3 mm (M5) 2 x 2,0 m / 3 x 2,5 m / 2 x 3,0 m
- Mains dimmable



SAUNA CEILING LIGHTING PRO+ 7 (3–4 m)

Code: 1516702

- 230 V, 16 W
- 50 000 h
- 2700 K
- Ra 90
- Dimensions of the projector: L 145 x W 150 x H 83, weight 1,03 kg
- Fiber lengths: Ø 3 mm (M5) 2 x 3,0 m / 3 x 3,5 m / 2 x 4,0 m
- Mains dimmable

PRODUCT INFORMATION

7-fiber sauna lighting set, with two optional fiber lengths. The set includes an IP65 LED projector, fiber harness, locking rings and a stove lens.

These sets are suitable for lighting medium-sized and large saunas. The recommended size of the sauna is 3–5 m². The fibers are made of glass and they can tolerate 180 °C heat. They can be installed on the ceiling of the sauna.

Projector VPAC27 has IP65 protection rating and it can be placed under the benches. Mains dimmable.

The projector's max. installation height from the floor is 80 cm.

In addition to standard fiber sets, we also manufacture fiber sets with special dimensions on request.

N.B! The fibers must not be cut.

SAUNA LINEAR GLASS SET

A ready-made sauna ceiling lighting set that provides even light to the ceiling of the sauna



SAUNA LINEAR GLASS SET

Code: 1815000

- Optical glass bar \varnothing 8 mm
- Length 1680 mm, can be shortened
- Fibers 2 x 3 m S-Flex 6
- Dimmable 1 – 10 V

PRODUCT INFORMATION

Sauna Linear Glass Set is a ready-made ceiling lighting set that includes one optical glass bar, a projector and a fiber harness F602. The glass bar is illuminated with a glass fiber at both ends. The projector is VPL30 XL. Installation of the projector in the sauna max 40 cm from the floor (with ambient temperature max 40 °C).



STOVE LIGHT FIBER 5M WITH A POWER SUPPLY

With the LED stove light fiber, the light is brought above the heater with a glass fiber, at the end of which a lens is installed.



STOVE LIGHT FIBER 5m with a power supply

Code: 1832010

- 1 W/350 mA
- IP55
- 95 – 240 V, 50/60 Hz
- Non-dimmable
- The max. installation height of the mounting box in the sauna 80 cm from the floor

PRODUCT INFORMATION

With LED stove light fiber, the light is brought above the heater with a glass fiber, at the end of which a lens is installed. The LED stove light fiber set includes a glass fiber (length 5 m), an LED, a stove lens (CR-09 gold) and a power supply (IP55 in a mounting box).



SAUNA STARRY SKY

With these sets, you can create a magnificent starry sky in the sauna.



SAUNA STARRY SKY 75

Code: 1815001

- 230 V, 16,5 W LED, 1500 lm
- 50 000 h
- 2700 K
- Ra > 90
- Dimensions of the projector:
L 145 x W 150 x H 83, weight 1,03 kg
- Fiber size Ø 1 mm (S-Flex I, BI)
- Fibers 75 pcs, lengths: 25 x 2,0 m /
25 x 2,5 m / 25 x 3,0 m
- Mains dimmable



SAUNA STARRY SKY 100

Code: 1815002

- 230 V, 16,5 W LED, 1500 lm
- 50 000 h
- 2700 K
- Ra > 90
- Dimensions of the projector:
L 145 x W 150 x H 83, weight 1,03 kg
- Fiber size Ø 1 mm (S-Flex I, BI)
- Fibers 100 pcs, lengths: 25 x 2,0 m /
50 x 2,5 m / 5 x 3,0 m
- Mains dimmable



SAUNA STARRY SKY LONG 100

Code: 1815012

- 230 V, 16,5 W LED, 1500 lm
- 50 000 h
- 2700 K
- Ra > 90
- Dimensions of the projector:
L 145 x W 150 x H 83, weight 1,03 kg
- Fiber size Ø 1 mm (S-Flex I, BI)
- Fiber 100 pcs, lengths: 25 x 4,0 m /
50 x 5,0 m / 25 x 6,0 m
- Mains dimmable

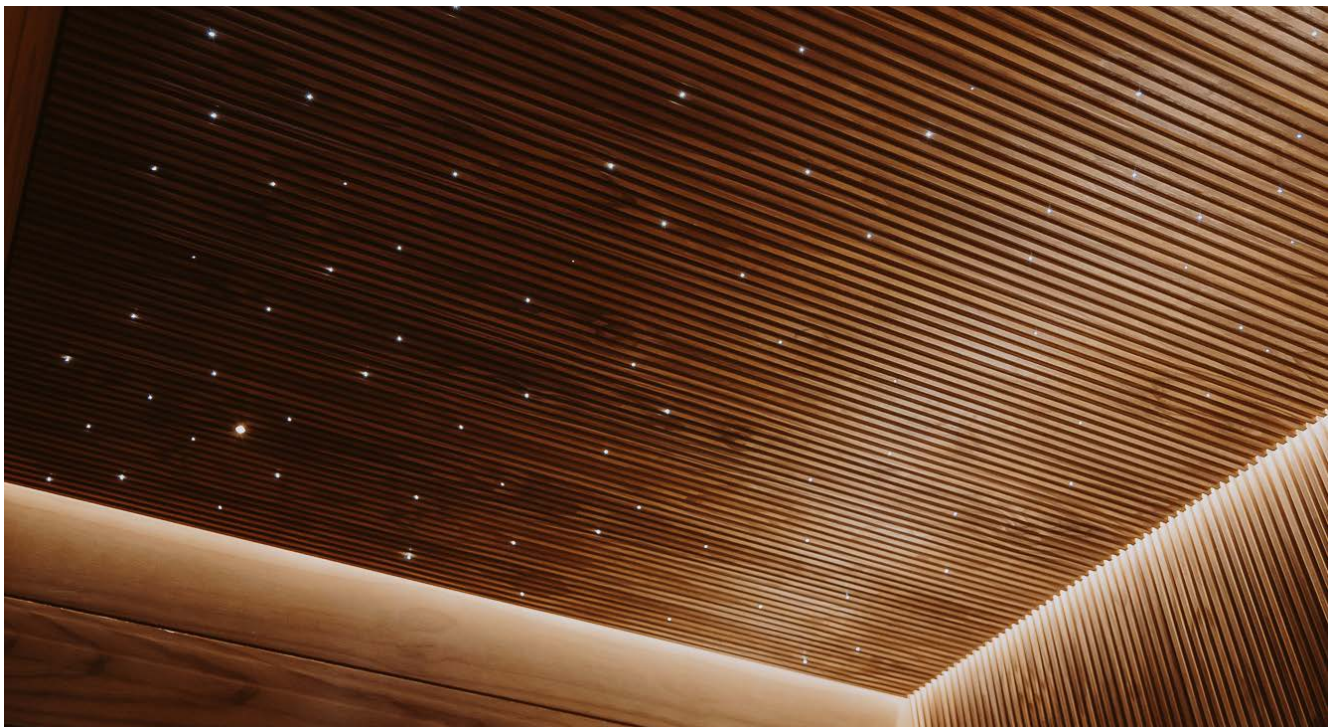

PRODUCT INFORMATION

The complete ready-to-install set includes a projector and a glass fiber harness with 75/100 fibers. With this set, you can create a magnificent starry sky in the sauna. The recommended size of the sauna is 1-6 m². The fibers are made of glass and they can tolerate 180 °C heat. Glass fibers can be installed on the ceiling of the sauna.

The VPAC27 projector of this set has IP65 protection rating and

can also be placed under sauna benches. Mains dimmable.

The installation height of the projector in the sauna is max. 80 cm from the floor.

N.B! The fiber must not be cut!

In addition to standard fiber sets, we also manufacture fiber sets with special dimensions on request.

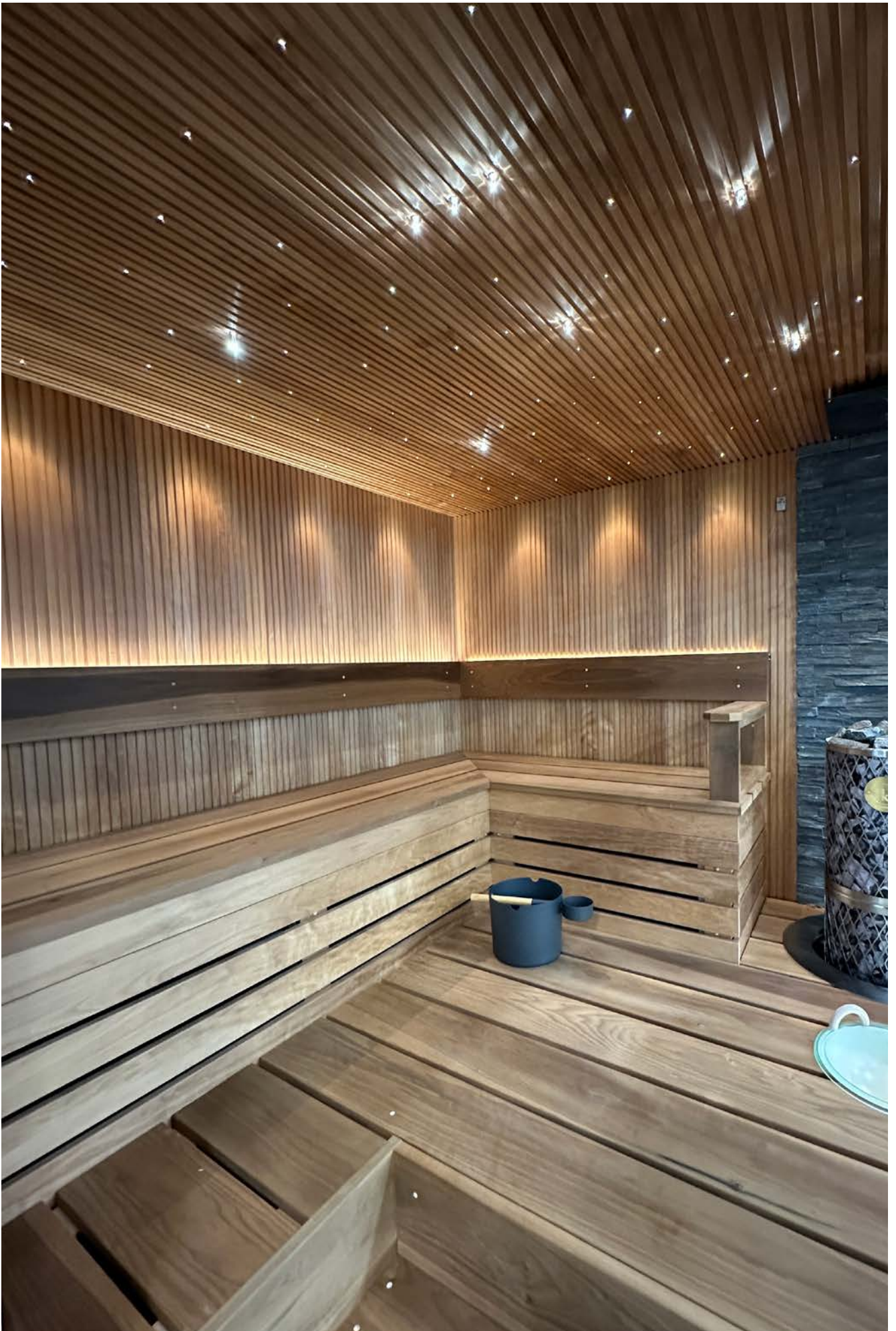

SAUNA LIGHTS AND LIGHT FITTINGS

A lens, crystal and even a water bowl or other light fitting can be installed on the fiber or LED. At the end of the fiber, the light opens at about 40-60 °. With a lens fitting, the light is focused into a 25-35 ° light beam, depending on the lens. The decorative crystal fittings spread the light even more than 180 °.



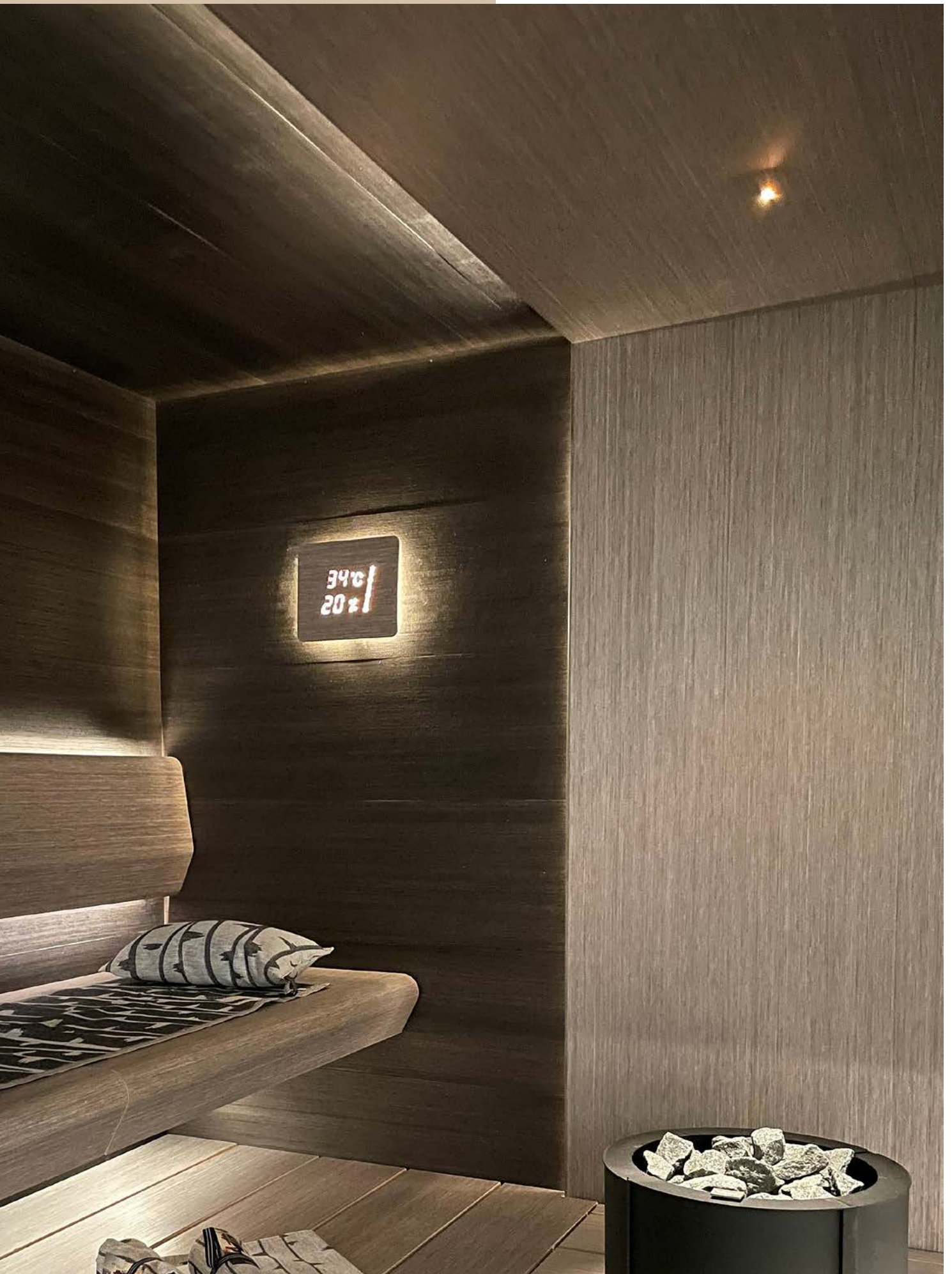

ASPECTU THERMO-HYGROMETER

A new type of digital thermo-hygrometer, projected through the panel



ASPECTU

Code: 1898020

- Koivu (Birch)*
- Ø 235 mm, H 16 mm



ASPECTU

Code: 1898021

- Hemlock
- Ø 235 mm, H 16 mm



ASPECTU

Code: 1898022

- Kelo
- Ø 235 mm, H 16 mm



ASPECTU SQ

Code: 1898027

- Koivu (Birch)*
- L 235 mm x W 235 mm x H 16 mm



ASPECTU SQ

Code: 1898028

- Hemlock
- L 235 mm x W 235 mm x H 16 mm



ASPECTU SQ

Code: 1898029

- Kelo
- L 235 mm x W 235 mm x H 16 mm

PRODUCT INFORMATION

Aspectu is a new type of digital thermo-hygrometer projected through a panel, and it also includes an electronic hourglass. The meter can be placed very freely in a suitable place on the wall of the sauna room. A suitable installation height is about 30 cm from the ceiling surface and at least 50 cm from the heater.

The power supply of the meter is at the end of 5-meter silicone wires. Aspectu's hourglass works as a so-called loop whenever the meter is on. Alternatively, a push button can be connected to the meter to reset the hourglass and always start over, duration 15 minutes.

* You can color the birch option with our sauna wax.

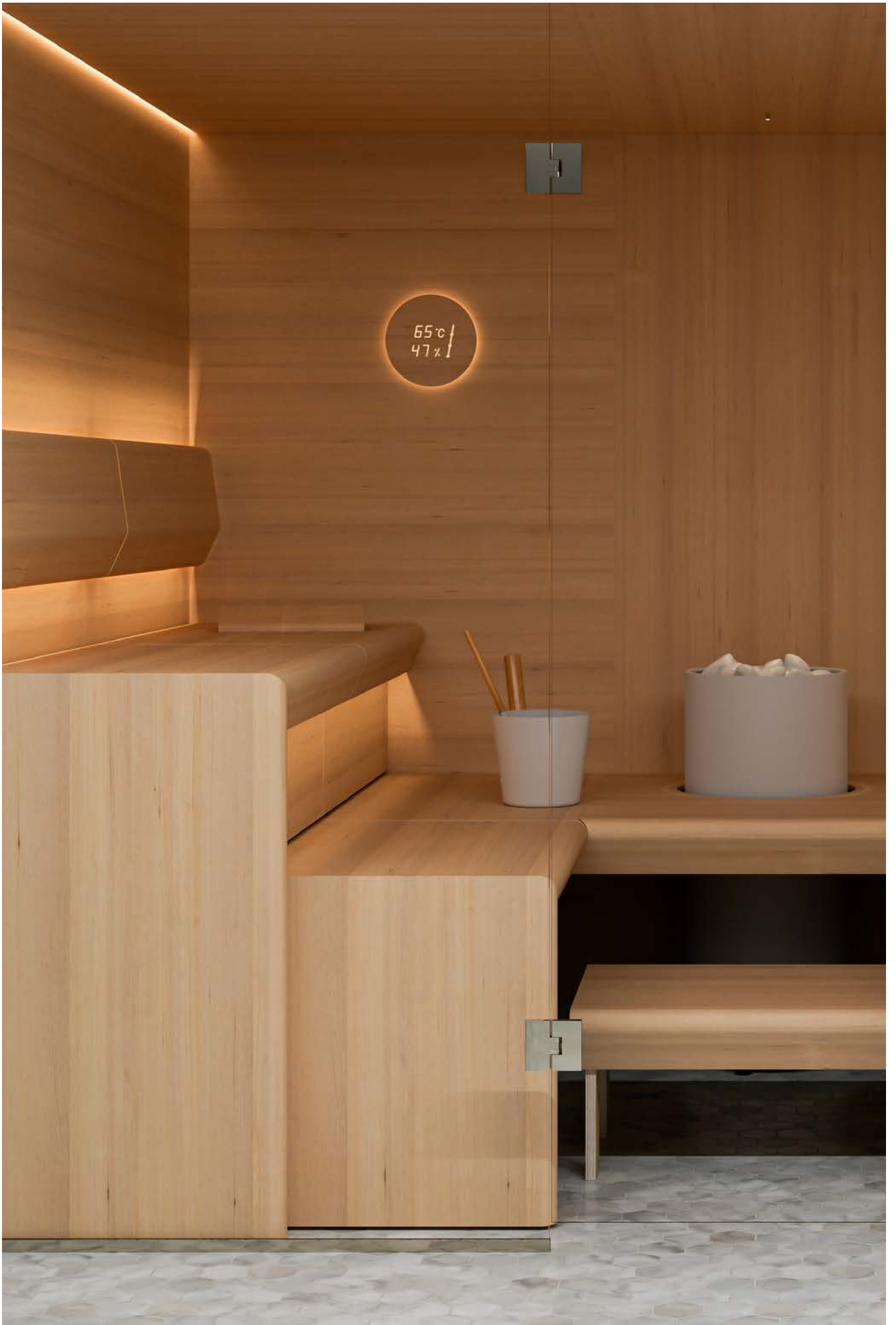

ECLIPSE SAUNA LIGHT

Eclipse is a sauna wall light that illuminates from its back. It can be placed freely in a suitable place on the wall of the sauna room.



ECLIPSE S

Code: 1832163

- Koivu (Birch)*
- Ø 203 mm, H 16 mm



ECLIPSE S

Code: 1832166

- Hemlock
- Ø 203 mm, H 16 mm



ECLIPSE S

Code: 1832169

- Kelo
- Ø 203 mm, H 16 mm



ECLIPSE M

Code: 1832164

- Koivu (Birch)*
- Ø 235 mm, H 16 mm



ECLIPSE M

Code: 1832167

- Hemlock
- Ø 235 mm, H 16 mm



ECLIPSE M

Code: 1832170

- Kelo
- Ø 235 mm, H 16 mm



ECLIPSE L

Code: 1832165

- Koivu (Birch)*
- Ø 267 mm, H 16 mm



ECLIPSE L

Code: 1832168

- Hemlock
- Ø 267 mm, H 16 mm



ECLIPSE L

Code: 1832171

- Kelo
- Ø 267 mm, H 16 mm

PRODUCT INFORMATION

Eclipse is a sauna wall light that illuminates from its back. It can be placed freely in a suitable place on the wall of the sauna room. A suitable installation height is approx. 30 cm from the ceiling surface and at least 50 cm from the heater. The light has a 5-meter silicone wire. A DC driver must be obtained separately.

The Eclipse 3 set is a set of three sauna wall lights that illuminate from their back. In addition to the luminaires, the set includes a suitable 24V DC driver. The installation height of the driver is max. 80 cm from the floor.

* You can color the birch option with our sauna wax.



ECLIPSE S, M, L

Code: 1832160

- Koivu (Birch)*
- Ø 203 mm, H 16 mm / Ø 235 mm, H 16 mm / Ø 267 mm, H 16 mm



ECLIPSE S, M, L

Code: 1832161

- Hemlock
- Ø 203 mm, H 16 mm / Ø 235 mm, H 16 mm / Ø 267 mm, H 16 mm

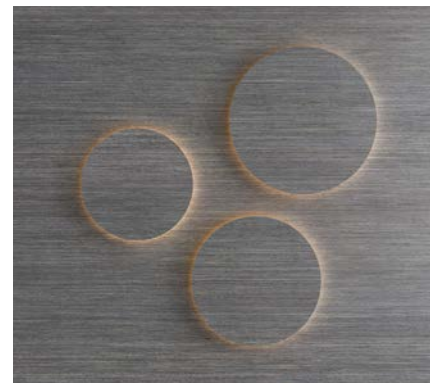

ECLIPSE S, M, L

Code: 1832162

- Kelo
- Ø 203 mm, H 16 mm / Ø 235 mm, H 16 mm / Ø 267 mm, H 16 mm

FANTASIA WALL FITTING

Fantasia is a crushed glass panel which is like a painting.

Fantasia is illuminated with two 6 mm fibers and it can be installed in a sauna behind an electric heater.



FANTASIA

Code: 1589017

- Size 1000 x 500 x 35 mm
- Projector and fibers to be obtained separately

FANTASIA FIBER HARNESS F602

Code: 1506015

- 2 x 3m, M8, glass fiber S-Flex 6



PRODUCT INFORMATION

A dashing and therapeutic element that changes character according to the chosen light effect. Depending on the chosen projector you can create effects like fire flame, northern lights or color change. With clear white light Fantasia looks like crushed ice. The projector and fiber set to be ordered separately. When installing Fantasia, observe the safety distances of the heater manufacturer.

GLOW WATER BOWL

You can finish your sauna with an illuminating water bowl fitting.



GLOW WATER BOWL FITTING WITH HANDLES

Code: 1545805

- Outer diameter of the bowl is 320 mm and height 180 mm
- Mounting hole diameter 285 mm
- The material of the bowl is glacier green acryl.



GLOW WATER BOWL FITTING WITH OUTLET VALVE

Code: 1545826

- Outer diameter of the bowl is 320 mm and height 180 mm
- Mounting hole diameter 285 mm
- The material of the bowl is glacier green acryl.



GLOW WATER BOWL FITTING WITH WATER OUTLET

Code: 1545804

- Outer diameter of the bowl is 320 mm and height 180 mm
- Mounting hole diameter 285 mm
- The material of the bowl is glacier green acryl.



PRODUCT INFORMATION

The bowl is illuminated with optical fiber and requires at least one 4 mm fiber. Several fibers can be connected according to your own taste, depending on how bright you want the bowl to be.

If the projector of the fiber set is equipped with color change, the bowl and the water in it can be made to change color beautifully. And for celebrating, you can also fill the bowl with ice and sink sauna beers in it, for example.

CR-18 AND CR-09 STOVE LENS

Very well suited as a sauna heater lens in sauna lighting.



LENS CR-18 (chrome)

Code: 1538009

- Ø 18 mm, H 17 mm



LENS CR-18 (gold)

Code: 1538006

- Ø 18 mm, H 17 mm



LENS CR-09 (chrome)

Code: 1540083

- Ø 12 mm, H 16 mm



LENS CR-09 (gold)

Code: 1540082

- Ø 12 mm, H 16 mm

PRODUCT INFORMATION

CR-18 lens fittings, in gold and chrome, are suitable for fibers C-Flex / S-Flex 4-6 M8. The diameter of the mounting hole is 8.5 mm and the outer diameter is 18 mm. Installation of the fitting requires 40 - 60 mm free space behind the ceiling or wall surface. Very well suited as a sauna heater lens for sauna lighting.

CR-09 lens fittings are suitable for Ø 1.5-3 mm fibers. The fitting has an M5 thread for fiber. The mounting hole has a diameter of 5.5 mm and requires 40 mm free space behind the wall or ceiling surface. Very well suited as a sauna heater lens, for example, in sauna lighting.

LIGHTHOUSE WALL LIGHT FITTING

Lighthouse is a simple and stylish sauna wall light fitting that is suitable for lighting with both fiber and LED.



LIGHTHOUSE LH-100

Code: 1545802

- Stainless steel
- Satin glass
- Mounting hole Ø 12 mm
- Crimpable ferrule M8 included

PRODUCT INFORMATION

The material of the light fitting is polished stainless steel and satin glass. Illuminated with one LED or one 2-4 mm fiber.

TORCH WALL LIGHT FITTING

Torch is a beautiful light fitting for the sauna wall, suitable for lighting with both fiber and LED.



TORCH TL-100

Code: 1545801

- Stainless steel
- Birch wood pin
- Satin glass
- Mounting hole Ø 12 mm
- Crimpable ferrule M8 included

PRODUCT INFORMATION

The material of the light fitting is polished stainless steel and satin glass. Illuminated with one LED or one 2-4 mm fiber.

SAUNA LINEAR GLASS FITTING

Sauna Linear Glass is a fitting that can be installed on the sauna ceiling.

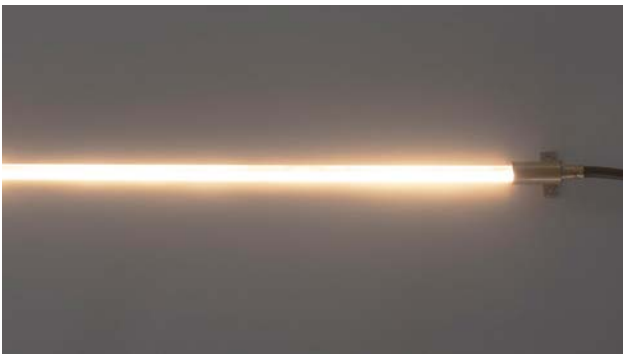

SAUNA LINEAR GLASS

Code: 1545844

- Optical glass bar Ø 8 mm
- Length 1680 mm, can be shortened

PRODUCT INFORMATION

The fitting is illuminated with glass fibers at both ends (fiber recommendation 2 x S-Flex 6). Fibers and projector are not included, they must be ordered separately. You can use the F602 fiber set for one light bar, for several light bars we make a fiber set to order. Recommended projector VPL30 XL (1501487). Installation of the projector in the sauna max 40 cm from the floor (with ambient temperature max 40 °C).

SAUNA THERMOMETER

The sauna thermometer has a polished stainless steel frame and a satin-coated polycarbonate back through which the meter is illuminated smoothly.



SAUNA THERMOMETER

Code: 1545812

- Stainless steel
- Ø 120 mm
- Recess 40 mm
- Height from the wall surface 20 mm



SAUNA THERMOMETER

Code: 1545853

- White
- Ø 120 mm
- Recess 40 mm
- Height from the wall surface 20 mm



SAUNA THERMOMETER

Code: 1545852

- Black
- Ø 120 mm
- Recess 40 mm
- Height from the wall surface 20 mm



SAUNA THERMOMETER SQ

Code: 1545828

- Stainless steel
- Size 120x120 mm
- Recess 40 mm
- Height from the wall surface 20 mm



SAUNA THERMOMETER SQ

Code: 1545855

- White
- Size 120x120 mm
- Recess 40 mm
- Height from the wall surface 20 mm



SAUNA THERMOMETER SQ

Code: 1545854

- Black
- Size 120x120 mm
- Recess 40 mm
- Height from the wall surface 20 mm

PRODUCT INFORMATION

The **round** and **square** sauna thermometer has a polished stainless steel frame and a satin-coated polycarbonate back, through which the meter is illuminated smoothly.

For illuminating, either one LED or one 2–4 mm fiber is needed. Installed together with wall paneling. Mounted to the wall panel with three stainless steel screws, included.

SAUNA HYGROMETER

The sauna hygrometer has a polished stainless steel frame and a satin-coated polycarbonate back through which the meter is illuminated smoothly.

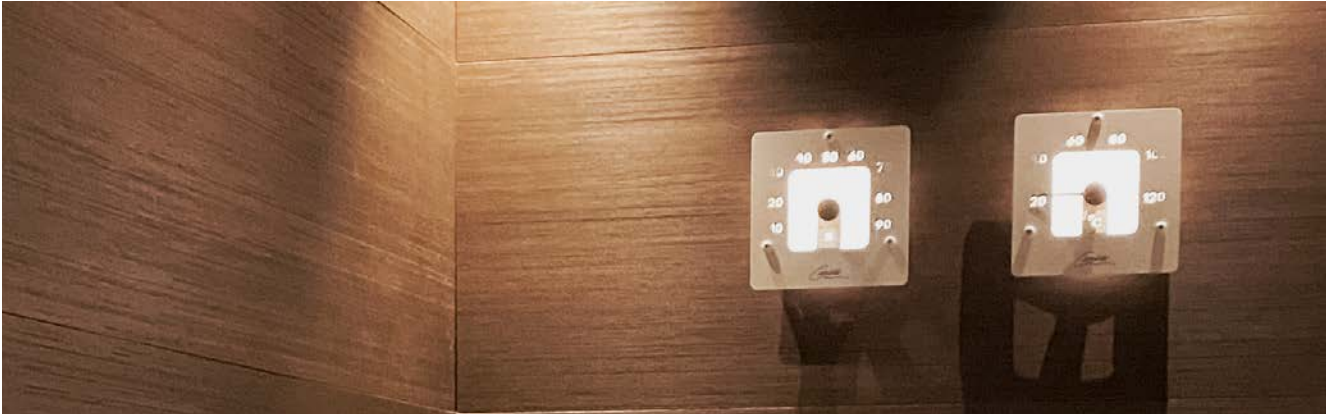

SAUNA HYGROMETER

Code: 1545820

- Stainless steel
- Ø 120 mm
- Recess 40 mm
- Height from the wall surface 20 mm



SAUNA HYGROMETER

Code: 1545857

- White
- Ø 120 mm
- Recess 40 mm
- Height from the wall surface 20 mm



SAUNA HYGROMETER

Code: 1545856

- Black
- Ø 120 mm
- Recess 40 mm
- Height from the wall surface 20 mm



SAUNA HYGROMETER SQ

Code: 1545849

- Stainless steel
- Size 120x120 mm
- Recess 40 mm
- Height from the wall surface 20 mm



SAUNA HYGROMETER SQ

Code: 1545859

- White
- Size 120x120 mm
- Recess 40 mm
- Height from the wall surface 20 mm



SAUNA HYGROMETER SQ

Code: 1545858

- Black
- Size 120x120 mm
- Recess 40 mm
- Height from the wall surface 20 mm

PRODUCT INFORMATION

The **round** and **square** sauna hygrometer has a polished stainless steel frame and a satin-coated polycarbonate back, through which the meter is illuminated smoothly.

For illuminating, either one LED or one 2–4 mm fiber is needed. Installed together with wall paneling. Mounted to the wall panel with three stainless steel screws, included.

KIVI THERMO-HYGROMETER

KIVI is a combined thermometer and hygrometer for a sauna.



KIVI THERMO-HYGROMETER

Code: 1545822

- Stainless steel
- Height 220 mm, width 205 mm
- Recess 40 mm
- Height from the wall surface 20 mm



KIVI THERMO-HYGROMETER

Code: 1545862

- White
- Height 220 mm, width 205 mm
- Recess 40 mm
- Height from the wall surface 20 mm



KIVI THERMO-HYGROMETER

Code: 1545861

- Black
- Height 220 mm, width 205 mm
- Recess 40 mm
- Height from the wall surface 20 mm

PRODUCT INFORMATION

KIVI is a combined thermometer and hygrometer for a sauna. It has a polished stainless steel frame and a satin-coated polycarbonate back, through which the meter is illuminated smoothly. For illuminating, two LEDs or two 2–4 mm fibers are needed.

Installed together with wall paneling. Mounted to the wall panel with five stainless steel screws, included.

Design: Frida Lindström



SAUNA LED LIGHTS

Our selection includes LED lights for sauna lighting. The collection also includes illuminated sauna water bowls and Sauna Linear lights.

SAUNA LED SETS

Cariitti LED lighting sets and expansion sets are available in 2700 K, 3000 K and 4000 K options. All our light fittings can be connected to these sets. The LEDs of these sets have IP67 rating, so they can be used in dry and humid places.



SAUNA LED SET 6 2700K

Code: 1532601

- Includes 6 LEDs (150 mA)
- 2700 K
- Serial connection cables (2 x 2,4 m)
- Jumpers (2 pcs)
- Extension cable (5 m)
- Dimmable power supply (IP20)
OTi DALI 15 (150 mA)



SAUNA LED SET 6 3000K

Code: 1532654

- Includes 6 LEDs (150 mA)
- 3000 K
- Serial connection cables (2 x 2,4 m)
- Jumpers (2 pcs)
- Extension cable (5 m)
- Dimmable power supply (IP20)
OTi DALI 15 (150 mA)



SAUNA LED SET 6 4000K

Code: 1532657

- Includes 6 LEDs (150 mA)
- 4000 K
- Serial connection cables (2 x 2,4 m)
- Jumpers (2 pcs)
- Extension cable (5 m)
- Dimmable power supply (IP20)
OTi DALI 15 (150 mA)



EXPANSION SET 3 2700K

Code: 1532602

- Includes 3 LEDs (150 mA)
- 2700 K
- Serial connection cable (2,4 m)
- Jumpers (2 pcs)
- With Expansion sets you can extend a basic Sauna LED Set 6 to 9, 12 or 15 LEDs.



EXPANSION SET 3 3000K

Code: 1532655

- Includes 3 LEDs (150 mA)
- 3000 K
- Serial connection cable (2,4 m)
- Jumpers (2 pcs)
- With Expansion sets you can extend a basic Sauna LED Set 6 to 9, 12 or 15 LEDs.



EXPANSION SET 3 4000K

Code: 1532658

- Includes 3 LEDs (150 mA)
- 4000 K
- Serial connection cable (2,4 m)
- Jumpers (2 pcs)
- With Expansion sets you can extend a basic Sauna LED Set 6 to 9, 12 or 15 LEDs.

PRODUCT INFORMATION

The LEDs of these sets require only a small 6 mm hole in the installation on sauna benches, as an example. The installation is much more invisible than previously. The clear installation instructions ensure that the installation cannot fail – the clips are carefully selected to avoid any misconnection.

The LED driver is the high-quality OTi DALI 15 (150 mA, partial load 3-15 W), and the set can be dimmed with a push-button or DALI control.

With Expansion Sets 3 you can expand your basic Sauna LED Set 6 up to 15 LEDs.

There are several additional items available for these sets, such as light fittings CR-03 (gold, chrome and black), a stove light fiber with a lens, thermometer, hygrometer and many others.

We recommend 2700 K for a sauna. If the sauna temperature is over +90°C, we recommend to use Cariitti fiber optic sets.

SAUNA LED STOVE LIGHT FIBER 2700K

With a stove light fiber you can extend your Sauna LED set or Sauna Linear LED set with a light for the heater.



SAUNA LED STOVE LIGHT FIBER 2700 K

Code: 1532633

- 3,5 m
- Includes 1 LED
- 2700 K
- 150 mA - 350 mA
- Lens CR-09



SAUNA LED STOVE LIGHT FIBER 2700 K

Code: 1532647

- 5 m
- Includes 1 LED
- 2700 K
- 150 mA - 350 mA
- Lens CR-09

EXTENSION CABLE FOR THE LED SETS

The extension cable is suitable to be used with our LED sets.



EXTENSION CABLE 1.5 M

Code: 1532607

- Length 1,5 m



EXTENSION CABLE 5 M

Code: 1532608

- Length 5 m

PRODUCT INFORMATION

With a **Sauna LED stove light fiber**, light is brought over the heater with a glass fiber and a lens is installed in the end of the fiber.

Can also be installed as a separate heater light (150-350 mA). In this case, suitable power supplies are, for example, 1545240, 1532443.

Also suitable for combination with the Sauna Linear LED 1M, 2M and 3M.

An **extension cable** is typically used when light fittings, such as a Thermometer or Hygrometer, are connected to the Sauna LED Set.

GLOW LED ILLUMINATED WATER BOWLS

An LED illuminated bowl can be used as an independent light.



GLOW LED WATER BOWL WITH HANDLES

Code: 1545200

- 1 W / 350 mA
- Power supply included
- Cable length 5 m
- Frosted glacier green acryl (satin)
- IP 67

GLOW LED WATER BOWL WITH OUTLET VALVE

Code: 1545221

- 1 W / 350 mA
- Power supply included
- Cable length 5 m
- Frosted glacier green acryl (satin)
- Outlet valve included
- IP 67

GLOW LED WATER BOWL WITH WATER OUTLET

Code: 1545220

- 1 W / 350 mA
- Power supply included
- Cable length 5 m
- Frosted glacier green acryl (satin)
- Outlet valve not included
- IP 67

PRODUCT INFORMATION

You can purchase the LED illuminated water bowl as a fully independent light, equipped with **wooden handles**, **bottom valve** or **water outlet**. The LED water bowl is delivered with a power supply, mounted in a waterproof IP55 mounting box. The installation height of the bowl is max. 1 m and the height of the power supply max. 80 cm from the sauna floor level.

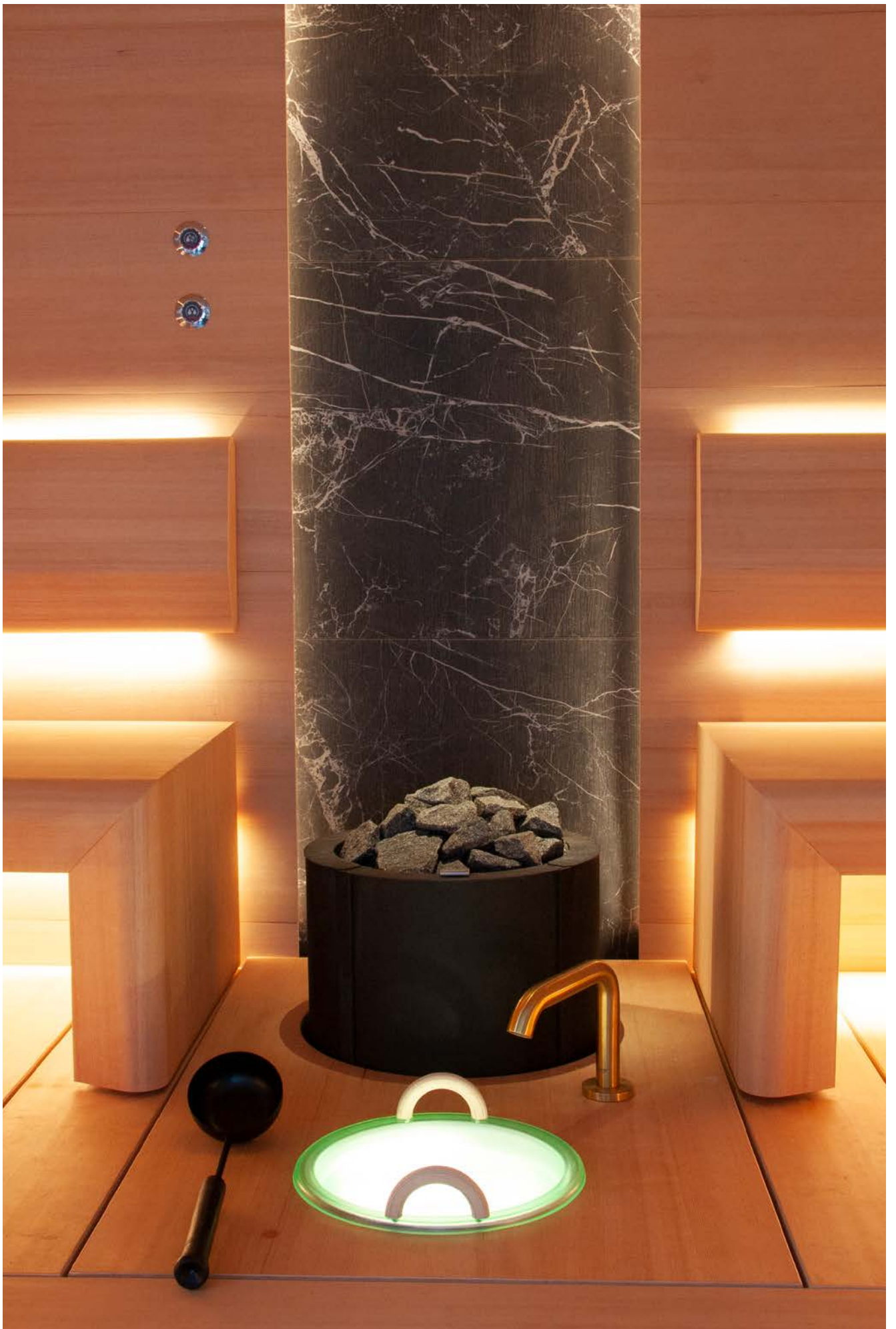





TAIVE[®] SAUNA

TAIVE sauna product line provides complete solutions for sauna interiors. Its smooth, elegant design creates a harmonious atmosphere in your sauna as well as other interiors in your spa. In addition, our thoughtfully designed lighting solutions emphasize the surfaces and shapes of the materials. TAIVE interior is a timeless, long-lasting design solution that will create unforgettable sauna experiences for you and your guests.

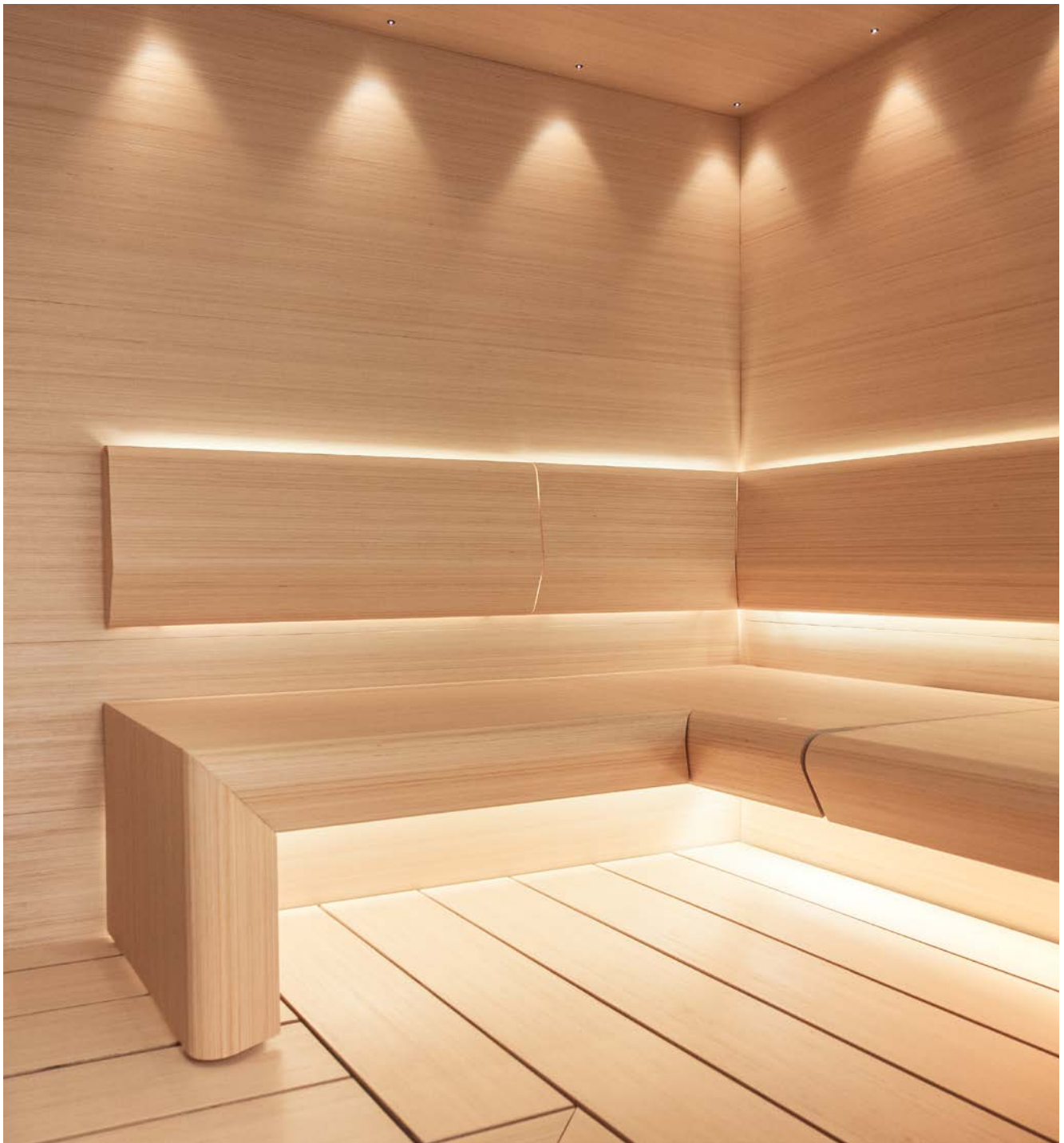

SAUNA IN A NEW LIGHT

We manufacture the TAIVE sauna collection at our own carpentry workshop in Espoo, Finland. TAIVE has the Key Flag symbol, as a proof of the Finnish origin. The TAIVE collection consists of streamlined sauna furniture and structures that you can combine to create a sauna that meets your wishes. We have high-quality sauna benches, sauna panels, and dressing room benches and cabinets made of Finnish birch plywood.





MATERIAL

The collection is made of Finnish birch plywood with Hemlock or CWP top veneer. All adhesive binding is made with weatherproof D4 glue with emission class M1. The structure guarantees very high stress strength and low deformation from moisture.



MANUFACTURING

High quality is the key factor in all CARIITTI products. The products are manufactured in the carpenter's workshop in Espoo, Finland, using domestic raw materials. The carbon footprint of the products is small. All CARIITTI products have been granted the Key Flag symbol as a proof of the Finnish origin.



DECOR

Our mission is to decorate saunas in a modern way, respecting tradition. The design of the collection enables a consistent style in all sauna and bathing areas, without compromising on comfort and practicality.



BENCHES

We always design custom-made sauna interiors on a case-by-case basis using TAIVE modules. In planning, we take into account the customer's wishes and always tell you any other solutions. The benches will be test-assembled in our carpenter's workshop.



WALL PANELS

The TAIVE panel is an all-side tongued interior panel designed for use in the sauna. Its surface is lined with Hemlock or CWP top veneer. The dimensions of the visible surface of the panel are 280 x 2400 mm and its thickness is 10 mm. The panel is also ideal for other premises.



ACCESSORIES

The accessories include a door handle and headrest in the same shape. We can also furnish dressing room facilities with TAIVE benches and cabinets.



Furniture and panels: KAARNA
Lighting: HUUHTO Easy LED profile

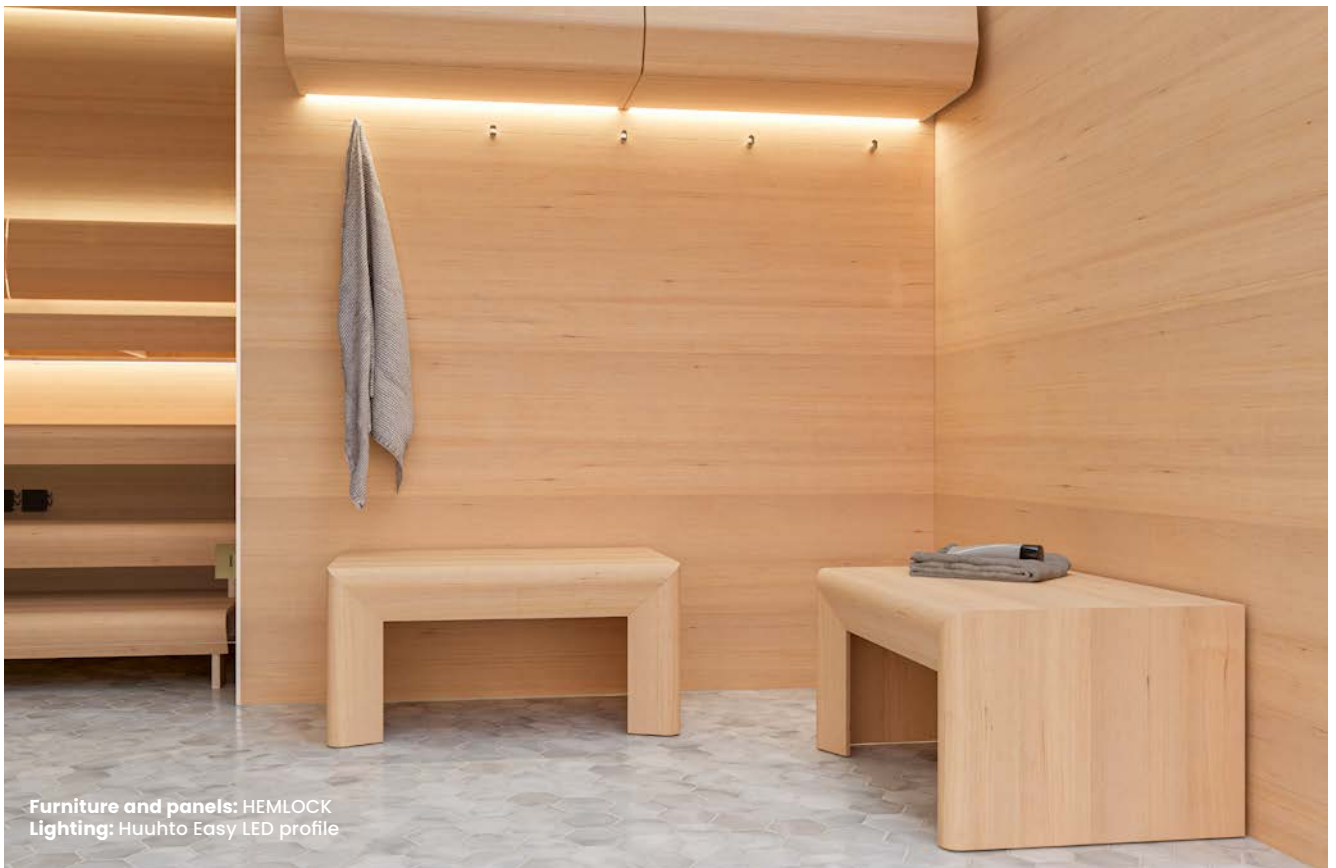

DRESSING ROOM FURNITURE

TAIVE dressing room modules are equal to TAIVE sauna benches which will make the interior design of the spa area harmonious and beautiful. You can choose a dressing room bench with or without a storage box, with different end module options, according to dimensions. With HUUHTO EASY LED lighting profiles you can complete the design.



TAIVE BASIC COLLECTION

In the TAIVE sauna collection, you will find a complete selection of different elements for building a sauna. With the TAIVE BASIC COLLECTION elements, you can create a stylish sauna.

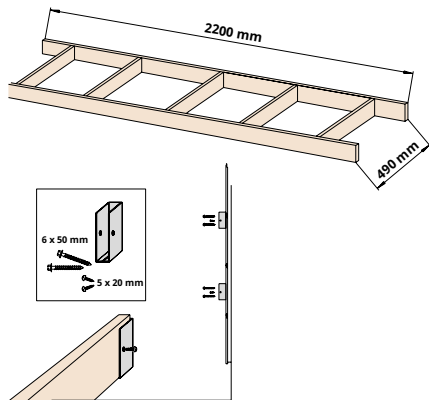

BENCH FRAME UNIT

Made of 20 mm thick birch plywood. The frame unit is delivered disassembled. The assembly is easy and quick. The unit includes brackets, 4 pcs.

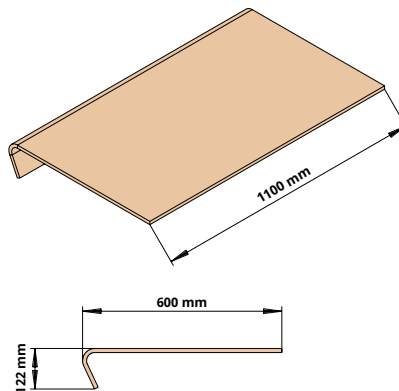

SITTING BENCH UNIT

To be installed directly on a TAIVE bench frame unit.

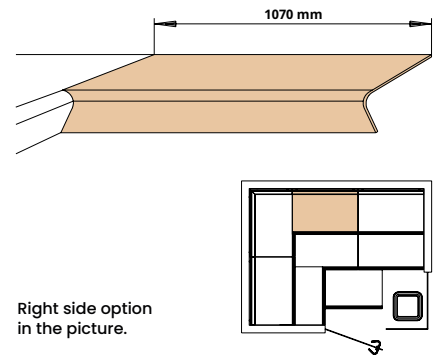

Right side option in the picture.

BENCH CORNER UNIT

Ready made corner element, which fits directly to the bench unit. Both right and left side options.

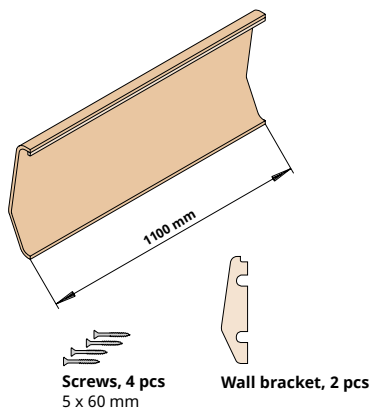

BACKREST UNIT

A ready-made backrest element. The set includes all necessary assembly accessories and brackets for the backrest.

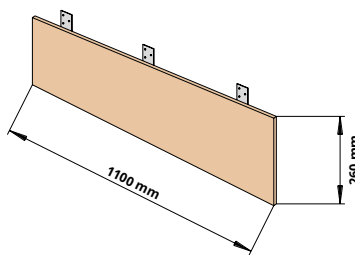

COVER PANEL

With cover panel you can cover the space between the upper and lower benches and also prevent objects from falling under the benches. Along with a cover panel you can install Sauna Linear LED light to the front edge of the benchframe.

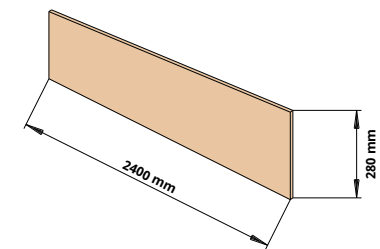

WALL PANELS

TAIVE wall panel is an interior panel, with all four sides tongued and specially designed to be used in a sauna. The size of the visible surface of the panel is 2400 x 280 mm and thickness 10 mm. The panel is well applicable also in other premises.

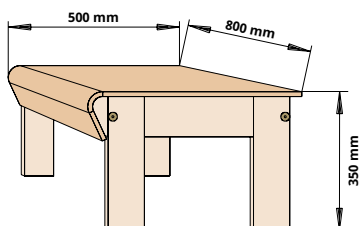

SAUNA STEP

A sturdy footstool. The cover is the same material as the sitting bench unit.

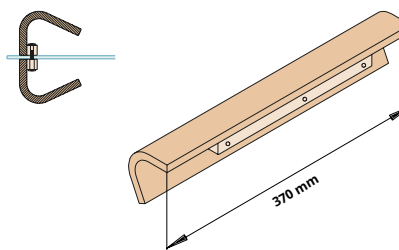

DOOR HANDLE

The same design as the front edge of the bench. The length is 370 mm. Installing to a 10 mm hole in a glass door, fastening from the middle.

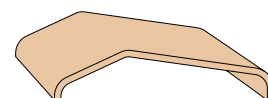

HEADREST

The same profile as the backrest. Size 300 x 300 x 70 mm



BASIC COLLECTION COLORS



HEMLOCK



KOIVU (CWP) "BIRCH"



KELO (CWP)

OTHER COLORS



If desired, you can finish the sitting bench units and wall panels with sauna wax. We recommend to spread sauna wax with a sponge for an even end result. Dust has to be removed from the surface before the wax treatment, using a soft brush, for example. Samples of the standard colours, used by Caritti, see beside.



KUURA
CWP KOIVU with white transparent sauna wax.



KAARNA
CWP KOIVU with brown transparent sauna wax.



NOKI
CWP KOIVU with black transparent sauna wax.

TAIVE SAUNA CABINS



HEMLOCK



TERVA



HIILI

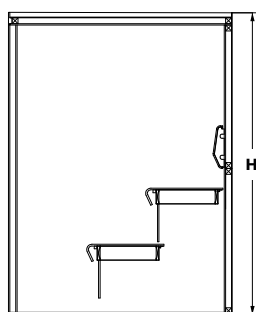
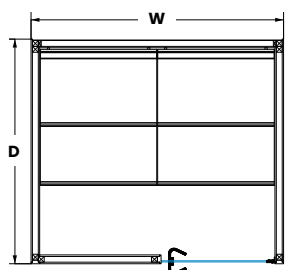

BASIC BENCH (closed wall)

Dimensions:

- D1243 x W1214 x H1950 mm (Single)
- D1600 x W1600 x H2150 mm
- D1600 x W1800 x H2150 mm
- D1800 x W1800 x H2150 mm
- D1800 x W2000 x H2150 mm
- D2000 x W2000 x H2150 mm



HEMLOCK



TERVA



HIILI

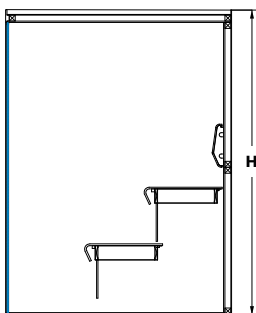
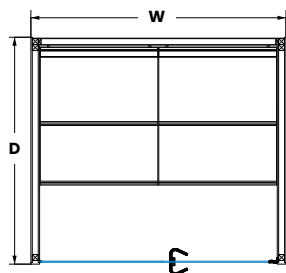

BASIC BENCH (glass wall)

Dimensions:

- D1600 x W1600 x H2150 mm
- D1600 x W1800 x H2150 mm
- D1800 x W1800 x H2150 mm
- D1800 x W2000 x H2150 mm
- D2000 x W2000 x H2150 mm



HEMLOCK



TERVA



HIILI

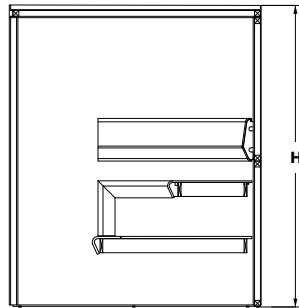
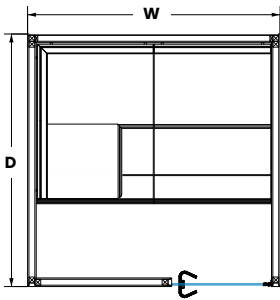

L-DIVAN BENCH (closed wall)

Dimensions:

D1800 x W1800 x H2150 mm

D1800 x W2000 x H2150 mm

D2000 x W2000 x H2150 mm



HEMLOCK



TERVA



HIILI

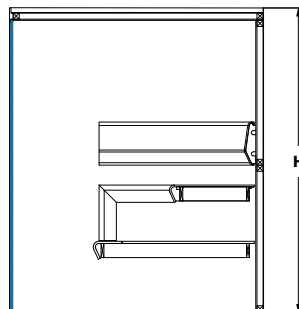
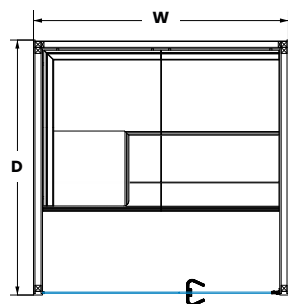

L-DIVAN BENCH (glass wall)

Dimensions:

D1800 x W1800 x H2150 mm

D1800 x W2000 x H2150 mm

D2000 x W2000 x H2150 mm

PRODUCT INFORMATION

The collection is made of Finnish birch plywood with Hemlock top veneer. All adhesive binding is made with weatherproof D4 glue with emission class M1. The structure guarantees very high stress strength and low deformation from moisture. Wood is a natural material and may have small branches. Variations in shades are also characteristic of wooden surfaces.

Delivery includes:

The cabin walls and ceiling elements, TAIVE benches, Sauna Linear LED lights for the benches and backrests, a glass wall and door with black hinges, an exhaust fan and fresh air vent.

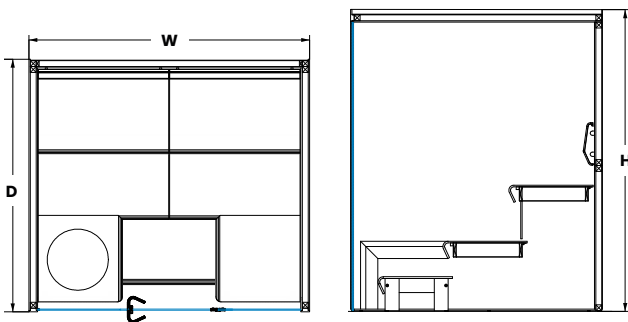
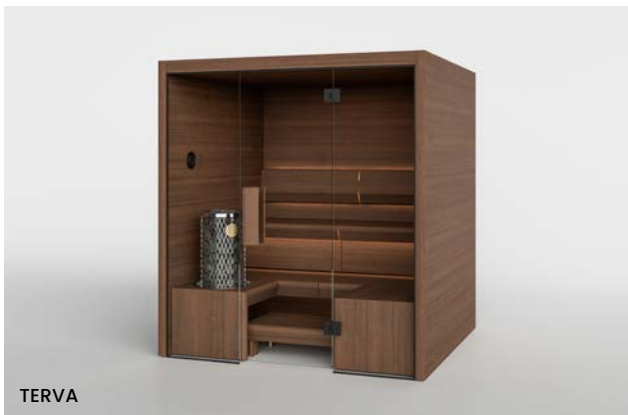

EXCLUSIVE BENCH (glass wall)

Dimensions:

D1800 x W2000 x H2150 mm

D2000 x W2000 x H2150 mm



HEMLOCK



TERVA



HIILI

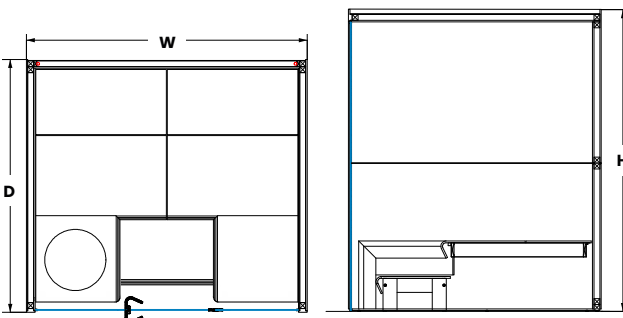

YOGA BENCH AND STOOLS (glass wall)

Dimensions:

D1800 x W2000 x H2150 mm

D2000 x W2000 x H2150 mm

STARLIGHT SETS

The starry sky lights are implemented using optical fiber technology, which can be used to create truly impressive lighting. One projector can illuminate hundreds of stars. The stars can be of different sizes and they can also be made to twinkle. We can also build a fantasy starry sky with color change and twinkle. Even a small starry sky can give the space the desired atmosphere. The possibilities are endless, we can even build a starry sky according to our own zodiac sign and finish larger stars with crystal fittings.

For sauna starry skies – please see page 38.





STARRY SKY SETS

A harness of a starry sky is illuminated with an LED. Recommended area 1-6 m². You can choose the color temperature 3000 K or 4000 K.



STARRY SKY 75

Code: 1532688

- 3000 K
- 1 W, 150 mA, 230 V
- Fiber C-Flex 7
- Fiber size Ø 0,75 mm x 75 pcs
- Fiber length 4,0 m



STARRY SKY 100

Code: 1527460

- 3000 K
- 16 W, 230 V
- Fiber C-Flex 7
- Fiber size Ø 0,75 mm x 100 pcs
- Fiber numbers and lengths:
50 x 2,5 m / 50 x 3,0 m



STARRY SKY 200

Code: 1527464

- 3000 K
- 16 W, 230 V
- Fiber C-Flex 7
- Fiber size Ø 0,75 mm x 200 pcs
- Fiber numbers and lengths:
50 x 2,5 m / 50 x 3,0 m / 50 x 3,5 m / 50 x 4,0 m



STARRY SKY 75

Code: 1532689

- 4000 K
- 1 W, 150 mA, 230 V
- Fiber C-Flex 7
- Fiber size Ø 0,75 mm x 75 pcs
- Fiber length 4,0 m



STARRY SKY 100

Code: 1527461

- 4000 K
- 16 W, 230 V
- Fiber C-Flex 7
- Fiber size Ø 0,75 mm x 100 pcs
- Fiber numbers and lengths:
50 x 2,5 m / 50 x 3,0 m



STARRY SKY 200

Code: 1527465

- 4000 K
- 16 W, 230 V
- Fiber C-Flex 7
- Fiber size Ø 0,75 mm x 200 pcs
- Fiber numbers and lengths:
50 x 2,5 m / 50 x 3,0 m / 50 x 3,5 m / 50 x 4,0 m

PRODUCT INFORMATION

The fibers of the sets are made of plastic and they can tolerate heat of 80 °C. The fibers must not be installed in the sauna, but they are suitable for steam rooms and infrared saunas with temperatures below 80 °C.

The projectors of the 3000 K sets are completely silent and have no disturbing fan. The light source is an LED with a warm color temperature (3000 K). All projectors in these sets are dimmable.

The projectors of the 4000 K sets are completely silent and have no disturbing fan. The light source is an LED with a cold color temperature (4000 K). All projectors in these sets are dimmable.

By using a set of LEDs and crystals, the number of fiber strands can be reduced.

N.B. Suitable glue is Epoxy or water-soluble wood glue. The use of all other adhesives may damage the fibers.

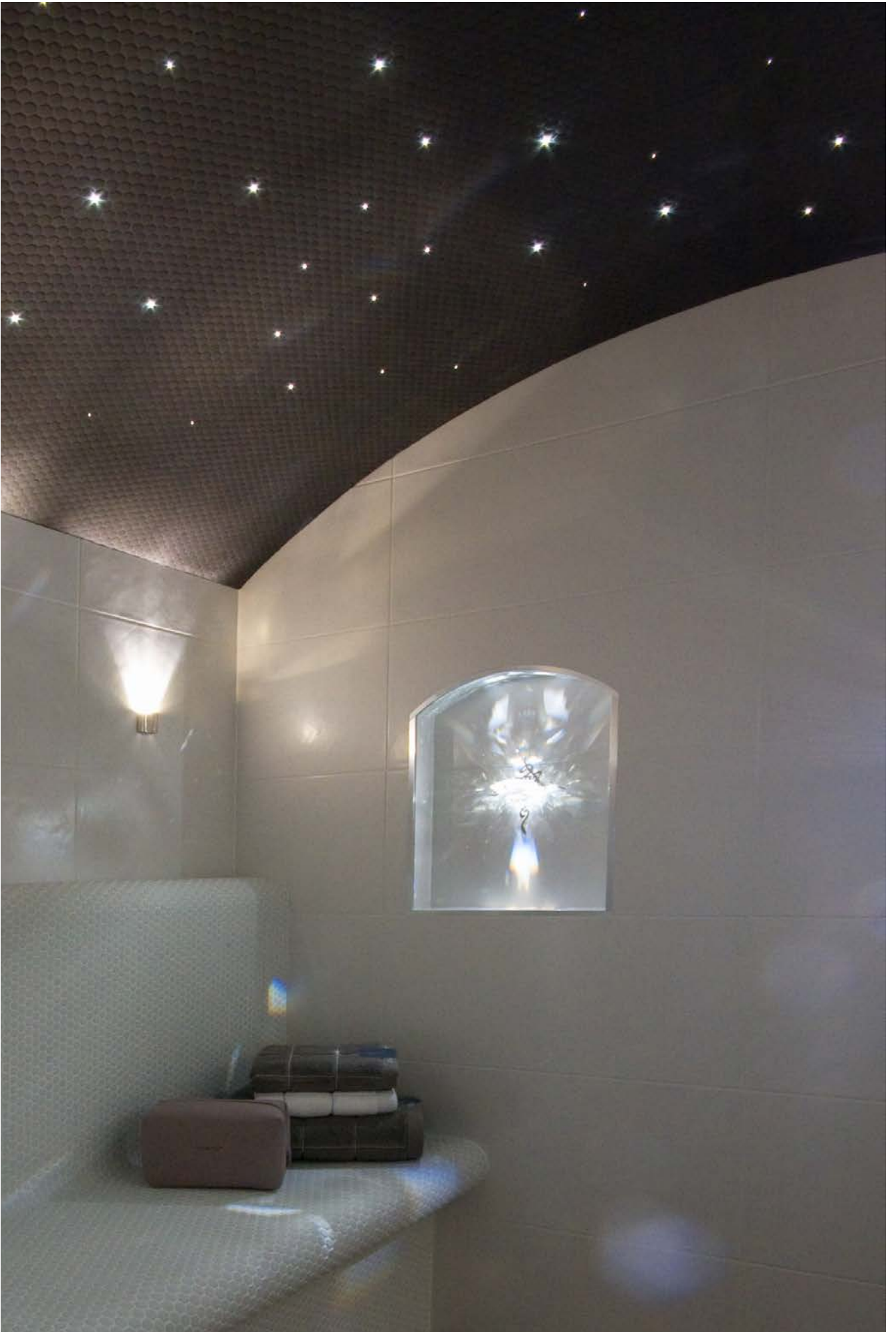

STARRY SKY TWINKLE SETS

These sets with twinkle effects are very well suited for medium-sized starry skies.



STARRY SKY TWINKLE 100

Code: 1527601

- Projector VPL30 T
- Fiber size Ø 0,75 mm
- Fiber numbers and lengths:
50 x 2,5 m / 50 x 3,0 m



STARRY SKY TWINKLE 200

Code: 1527603

- Projector VPL30 T
- Fiber size Ø 0,75 mm
- Fiber numbers and lengths:
50 x 2,5 m / 50 x 3,0 m / 50 x 3,5 m /
50 x 4,0 m



STARRY SKY TWINKLE 300

Code: 1527608

- Projector VPL30 T
- Fiber size Ø 0,75 mm
- Fiber numbers and lengths:
75 x 3,0 m / 75 x 3,5 m / 75 x 4,0 m /
75 x 4,5 m



STARRY SKY BLUE TWINKLE 100

Code: 1527605

- Projector VPL30 CT
- Fiber size Ø 0,75 mm
- Fiber numbers and lengths:
50 x 2,5 m / 50 x 3,0 m



STARRY SKY BLUE TWINKLE SET 200

Code: 1527607

- Projector VPL30 CT
- Fiber size Ø 0,75 mm
- Fiber numbers and lengths:
50 x 2,5 m / 50 x 3,0 m / 50 x 3,5 m /
50 x 4,0 m



STARRY SKY BLUE TWINKLE 300

Code: 1527609

- Projector VPL30 CT
- Fiber size Ø 0,75 mm
- Fiber numbers and lengths:
75 x 3,0 m / 75 x 3,5 m / 75 x 4,0 m /
75 x 4,5 m



STARRY SKY KALEIDOSCOPE 100

Code: 1527614

- Projector VPL30 KT
- Fiber size Ø 0,75 mm
- Fiber numbers and lengths:
50 x 2,5 m / 50 x 3,0 m



STARRY SKY KALEIDOSCOPE 200

Code: 1527615

- Projector VPL30 KT
- Fiber size Ø 0,75 mm
- Fiber numbers and lengths:
50 x 2,5 m / 50 x 3,0 m / 50 x 3,5 m /
50 x 4,0 m



STARRY SKY KALEIDOSCOPE 300

Code: 1527616

- Projector VPL30 KT
- Fiber size Ø 0,75 mm
- Fiber numbers and lengths:
75 x 3,0 m / 75 x 3,5 m / 75 x 4,0 m /
75 x 4,5 m



Twinkle effect



Blue twinkle effect



Kaleidoscope effect

PRODUCT INFORMATION

The projector is equipped with a twinkle effect that makes the stars slowly twinkle. In the twinkling effect, the stars brighten and dim without a regular rhythm. Depending on the effect, the light sources of the projector are white 4000 K or blue LEDs or white, blue and cyan LEDs.

The product is available with three different effect options:

The light source of the twinkle effect is white 4000 K LEDs.

The light source of the blue twinkle effect is blue LEDs.

The kaleidoscope effect is implemented with white, blue and cyan-colored LEDs.

By using a set of LEDs and crystals, the number of fiber strands can be reduced.

N.B. Suitable glue is epoxy or water-soluble wood glue. Using any other adhesive may damage the fibers.

STARRY SKY CRYSTAL TWINKLE SETS

These sets are very well suited for medium-sized starry skies. The sets have 100 pcs of 0.75 mm fibers and 18 pcs of 3.0 mm fibers with crystal fittings. The size of the starry sky is about 3–8 m².



STARRY SKY CRYSTAL TWINKLE SET

Code: 1527610

- Chrome
- Projector VPL30 T
- Ø 0,75 mm fibers:
25 pcs 2,0 m / 25 pcs 2,5 m / 25 pcs 3,0 m / 25 pcs 3,5 m
- Ø 3,0 mm fibers:
4 pcs 2,0 m / 5 pcs 2,5 m / 5 pcs 3,0 m / 4 pcs 3,5 m



STARRY SKY CRYSTAL TWINKLE SET

Code: 1527611

- Gold
- Projector VPL30 T
- Ø 0,75 mm fibers:
25 pcs 2,0 m / 25 pcs 2,5 m / 25 pcs 3,0 m / 25 pcs 3,5 m
- Ø 3,0 mm fibers:
4 pcs 2,0 m / 5 pcs 2,5 m / 5 pcs 3,0 m / 4 pcs 3,5 m



STARRY SKY CRYSTAL BLUE TWINKLE SET

Code: 1527612

- Chrome
- Projector VPL30 CT
- Ø 0,75 mm fibers:
25 pcs 2,0 m / 25 pcs 2,5 m / 25 pcs 3,0 m / 25 pcs 3,5 m
- Ø 3,0 mm fibers:
4 pcs 2,0 m / 5 pcs 2,5 m / 5 pcs 3,0 m / 4 pcs 3,5 m



STARRY SKY CRYSTAL BLUE TWINKLE SET

Code: 1527613

- Gold
- Projector VPL30 CT
- Ø 0,75 mm fibers:
25 pcs 2,0 m / 25 pcs 2,5 m / 25 pcs 3,0 m / 25 pcs 3,5 m
- Ø 3,0 mm fibers:
4 pcs 2,0 m / 5 pcs 2,5 m / 5 pcs 3,0 m / 4 pcs 3,5 m

PRODUCT INFORMATION

The fibers of the sets are made of plastic and they can tolerate 80 °C heat. The fibers must not be installed in the sauna. Suitable for steam rooms and infrared saunas with temperatures below 80 °C.

N.B. Suitable glue Epoxy or water-soluble wood glue. The use of all other adhesives may damage the fibers.

The product is available with two effect options:

The light source of the twinkle effect with white 4000 K LEDs.
The light source of the blue twinkle effect with blue LEDs.

Crystals of the sets:

6 pcs CR-12
6 pcs CR-16
6 pcs CR-31



Twinkle effect



Kaleidoscope effect



Blue twinkle effect

STARRY SKY CRYSTAL SET

Complete ready-to-install crystal starry sky set.

This set is suitable as a crystal starry sky in a room of about 3-5 m².



STARRY SKY CRYSTAL SET (6 crystals)

Code: 1532611

- Chrome
- Light source 1 W / 150 mA LED (4000K)
- 2 pcs CR-12
- 2 pcs CR-16
- 2 pcs CR-31



PRODUCT INFORMATION

The crystal parts are available in lengths of 12, 16 and 31 mm, the diameter of the mounting hole is Ø 12 mm and the outer diameter of the light fitting is Ø 18 mm. The installation depth required for the fitting is small, only 30 mm. The product requires serial connection.

The set also includes 75 optical fibers with length 4 metres. The fiber size is Ø 0.75 mm. The fibers in the set are made of plastic

and they can tolerate 80 °C heat. The fibers in the set must not be installed in the sauna, but they are suitable for steam and infrared saunas where the temperature is below 80 °C.

N.B. The suitable glue is Epoxy or water-soluble wood glue. The use of all other adhesives may damage the fibers.

The power supply is dimmable with a push button or DALI control.

CRYSTAL KIT 6

A kit of 6 crystals, with chrome or gold finish



CRYSTAL KIT 6

Code: 1532621

- Chrome
- 2 pcs CR-12
- 2 pcs CR-16
- 2 pcs CR-31
- Installing hole diameter \varnothing 12 mm
- Outer diameter \varnothing 18 mm
- Crystal length 12 / 16 / 31 mm



CRYSTAL KIT 6

Code: 1532622

- Gold
- 2 pcs CR-12
- 2 pcs CR-16
- 2 pcs CR-31
- Installing hole diameter \varnothing 12 mm
- Outer diameter \varnothing 18 mm
- Crystal length 12 / 16 / 31 mm

PRODUCT INFORMATION

Suitable to be used with LED lighting sets IP67 and in fiber ends M5 with adapter 1548435.

The installation requires 30 mm free space behind the ceiling or wall surface.

The lengths of the crystals are 12, 16 and 31 mm, installing hole diameter \varnothing 12 mm and outer diameter \varnothing 18 mm.

CRYSTAL KIT 3

A kit of 3 crystals, with chrome finish



CRYSTAL KIT 3 XS

Code: 1532623

- Chrome
- Includes 3 pcs CR-12 crystals
- Installing hole diameter Ø 12 mm
- Outer diameter Ø 18 mm
- Crystal length 12 mm



CRYSTAL KIT 3 S

Code: 1532625

- Chrome
- Includes 3 pcs CR-16 crystals
- Installing hole diameter Ø 12 mm
- Outer diameter Ø 18 mm
- Crystal length 16 mm



CRYSTAL KIT 3 M

Code: 1532627

- Chrome
- Includes 3 pcs CR-31 crystals
- Installing hole diameter Ø 12 mm
- Outer diameter Ø 18 mm
- Crystal length 31 mm



CRYSTAL KIT 3 L

Code: 1532629

- Chrome
- Includes 3 pcs CR-20 crystals
- Installing hole diameter Ø 12 mm
- Outer diameter Ø 20 mm



CRYSTAL KIT 3 XL

Code: 1532631

- Chrome
- Includes 3 pcs CR-30 crystals
- Installing hole diameter Ø 14 mm
- Outer diameter Ø 30 mm

PRODUCT INFORMATION

Suitable to be used with LED lighting sets IP67.

The installation requires 30 mm free space behind the ceiling or wall surface.

CRYSTAL KIT 3

A kit of 3 crystals, with gold finish



CRYSTAL KIT 3 XS

Code: 1532624

- Gold
- Includes 3 pcs CR-12 crystals
- Installing hole diameter \varnothing 12 mm
- Outer diameter \varnothing 18 mm
- Crystal length 12 mm



CRYSTAL KIT 3 S

Code: 1532626

- Gold
- Includes 3 pcs CR-16 crystals
- Installing hole diameter \varnothing 12 mm
- Outer diameter \varnothing 18 mm
- Crystal length 16 mm



CRYSTAL KIT 3 M

Code: 1532628

- Gold
- Includes 3 pcs CR-31 crystals
- Installing hole diameter \varnothing 12 mm
- Outer diameter \varnothing 18 mm
- Crystal length 31 mm



CRYSTAL KIT 3 L

Code: 1532630

- Gold
- Includes 3 pcs CR-20 crystals
- Installing hole diameter \varnothing 14 mm
- Outer diameter \varnothing 20 mm



CRYSTAL KIT 3 XL

Code: 1532632

- Gold
- Includes 3 pcs CR-30 crystals
- Installing hole diameter \varnothing 12 mm
- Outer diameter \varnothing 30 mm

PRODUCT INFORMATION

Suitable to be used with LED lighting sets IP67.

The installation requires 30 mm free space behind the ceiling or wall surface.

STEAM ROOM LIGHTING

There are numerous lighting options available for the lighting of a steam room, implemented with LEDs, light fittings and fiber sets. It is popular to use color lighting in a steam room to color the steam or to implement lighting in e.g. with Northern Lights effect or Ultra Ambient LED strips.





STEAM BATH LED SET 3000K

The set allows you to illuminate your steam room with a wide range of our light fittings.



STEAM BATH LED SET 1

Code: 1832132

- 3000 K
- 1 x LED 150 mA
- Cable length 5 m



STEAM BATH LED SET 2

Code: 1832133

- 3000 K
- 2 x LED 150 mA
- Cable length 5 m



STEAM BATH LED SET 3

Code: 1532653

- 3000 K
- 3 x LED 150 mA
- Cable length 5 m



STEAM BATH LED SET 6

Code: 1532609

- 3000 K
- 6 x LED 150 mA
- Cable length 5 m

PRODUCT INFORMATION

The set allows you to illuminate a steam room with a wide range of light fittings, e.g. with crystal (CR-12, CR-16, CR-31, CR-20, CR-30), CR-05 fitting (with satin lens), 75-fiber starry sky harness or even impressive SY and KIHLA fittings.

The power supply is high-quality Osram OTi DALI (1532443 or 1532296), and the series can be dimmed either with a push button or a DALI controller.

STARRY SKY FIBER HARNESS

You can connect this starry sky harness to e.g. Steam Bath LED Set.



STARRY SKY FIBER HARNESS 75

Code: 1509102

- Fiber C-Flex 7
- Fiber size Ø 0,75 mm x 75 pcs
- Fiber length 4 m
- No LED included

STEAM BATH EXTENSION SET

With this extension set, you can extend the Steam Bath LED set with 3 LEDs.



STEAM BATH EXTENSION SET 3

Code: 1532610

- 3000 K
- 3 x LED 150 mA
- Cable length 5 m

PRODUCT INFORMATION

Extension set to the Steam Bath LED set, 3000 K (150 mA), cable length 5 meters.

With this extension set, you can extend a Steam Bath LED set 3 or 6 with another 3 LEDs.

You can connect three extension sets to one Steam Bath LED 6 set so that the total number of LEDs is a maximum of 15 pcs/set. IP67.

CR-03 KIT 6

The kit includes 6 pcs of CR-03 fittings. The fittings can be connected to any of Cariitti's LED sets as well as to all fibers with an M5 ferrule. When used with fibers, an M5/6 mm extension ferrule is required in the fiber end.



CR-03 KIT 6

Code: 1532612

- Gold
- 6 pcs CR-03 fittings
- Installing hole Ø 12 mm
- Outer diameter Ø 14 mm
- Locking spring



CR-03 KIT 6

Code: 1532613

- Chrome
- 6 pcs CR-03 fittings
- Installing hole Ø 12 mm
- Outer diameter Ø 14 mm
- Locking spring



CR-03 KIT 6

Code: 1532614

- Black
- 6 pcs CR-03 fittings
- Installing hole Ø 12 mm
- Outer diameter Ø 14 mm
- Locking spring

CR-05 KIT 6

The kit includes 6 pcs of CR-05 fittings. The fittings can be connected to any of Cariitti's LED sets as well as to all fibers with an M5 ferrule. When used with fibers, an M5/6 mm extension ferrule is required in the fiber end.



CR-05 KIT 6 (clear lens)

Code: 1532615

- Gold
- Lens: clear
- 6 pcs CR-05 fittings
- Installing hole Ø 12 mm
- Outer diameter Ø 18 mm
- Locking spring



CR-05 KIT 6 (clear lens)

Code: 1532617

- Chrome
- Lens: clear
- 6 pcs CR-05 fittings
- Installing hole Ø 12 mm
- Outer diameter Ø 18 mm
- Locking spring



CR-05 KIT 6 (satin lens)

Code: 1532616

- Gold
- Lens: satin
- 6 pcs CR-05 fittings
- Installing hole Ø 12 mm
- Outer diameter Ø 18 mm
- Locking spring



CR-05 KIT 6 (satin lens)

Code: 1532618

- Chrome
- Lens: satin
- 6 pcs CR-05 fittings
- Installing hole Ø 12 mm
- Outer diameter Ø 18 mm
- Locking spring

CR-07 KIT 6

The kit includes 6 pcs of CR-07 fittings. The fittings can be connected to any of Cariitti's LED sets as well as to all fibers with an M5 ferrule. When used with fibers, an M5/6 mm extension ferrule is required in the fiber end.



CR-07 KIT 6 (clear lens)

Code: 1532643

- Gold
- Lens: clear
- 6 pcs CR-07 fittings
- Installing hole \varnothing 12 mm
- Outer diameter \varnothing 15 mm
- Locking spring



CR-07 KIT 6 (clear lens)

Code: 1532641

- Chrome
- Lens: clear
- 6 pcs CR-07 fittings
- Installing hole \varnothing 12 mm
- Outer diameter \varnothing 15 mm
- Locking spring



CR-07 KIT 6 (clear lens)

Code: 1532645

- Black
- Lens: clear
- 6 pcs CR-07 fittings
- Installing hole \varnothing 12 mm
- Outer diameter \varnothing 15 mm
- Locking spring



CR-07 KIT 6 (satin lens)

Code: 1532644

- Gold
- Lens: satin
- 6 pcs CR-07 fittings
- Installing hole \varnothing 12 mm
- Outer diameter \varnothing 15 mm
- Locking spring



CR-07 KIT 6 (satin lens)

Code: 1532642

- Chrome
- Lens: satin
- 6 pcs CR-07 fittings
- Installing hole \varnothing 12 mm
- Outer diameter \varnothing 15 mm
- Locking spring



CR-07 KIT 6 (satin lens)

Code: 1532646

- Black
- Lens: satin
- 6 pcs CR-07 fittings
- Installing hole \varnothing 12 mm
- Outer diameter \varnothing 15 mm
- Locking spring

GP-65 KIT 6

The fitting GP-65 is ideal for illuminating floor surfaces, stairs and various recesses in both damp and dry premises.



GP-65 KIT 6

Code: 1532619

- Gold
- 6 pcs GP-65 fittings
- Installing hole \varnothing 12 mm
- Outer diameter \varnothing 22 mm
- Locking spring



GP-65 KIT 6

Code: 1532620

- Chrome
- 6 pcs GP-65 fittings
- Installing hole \varnothing 12 mm
- Outer diameter \varnothing 22 mm
- Locking spring

PRODUCT INFORMATION

Suitable for use with fiber or LED. When lighting with fibers, the recommended fiber is \varnothing 2-3 mm. When used with fibers, an M5/6 mm extension ferrule is needed in the fiber end.

KIHLA CRYSTAL FITTING

A crystal light fitting that is suitable for use in all spaces, but most commonly used for steam room lighting.

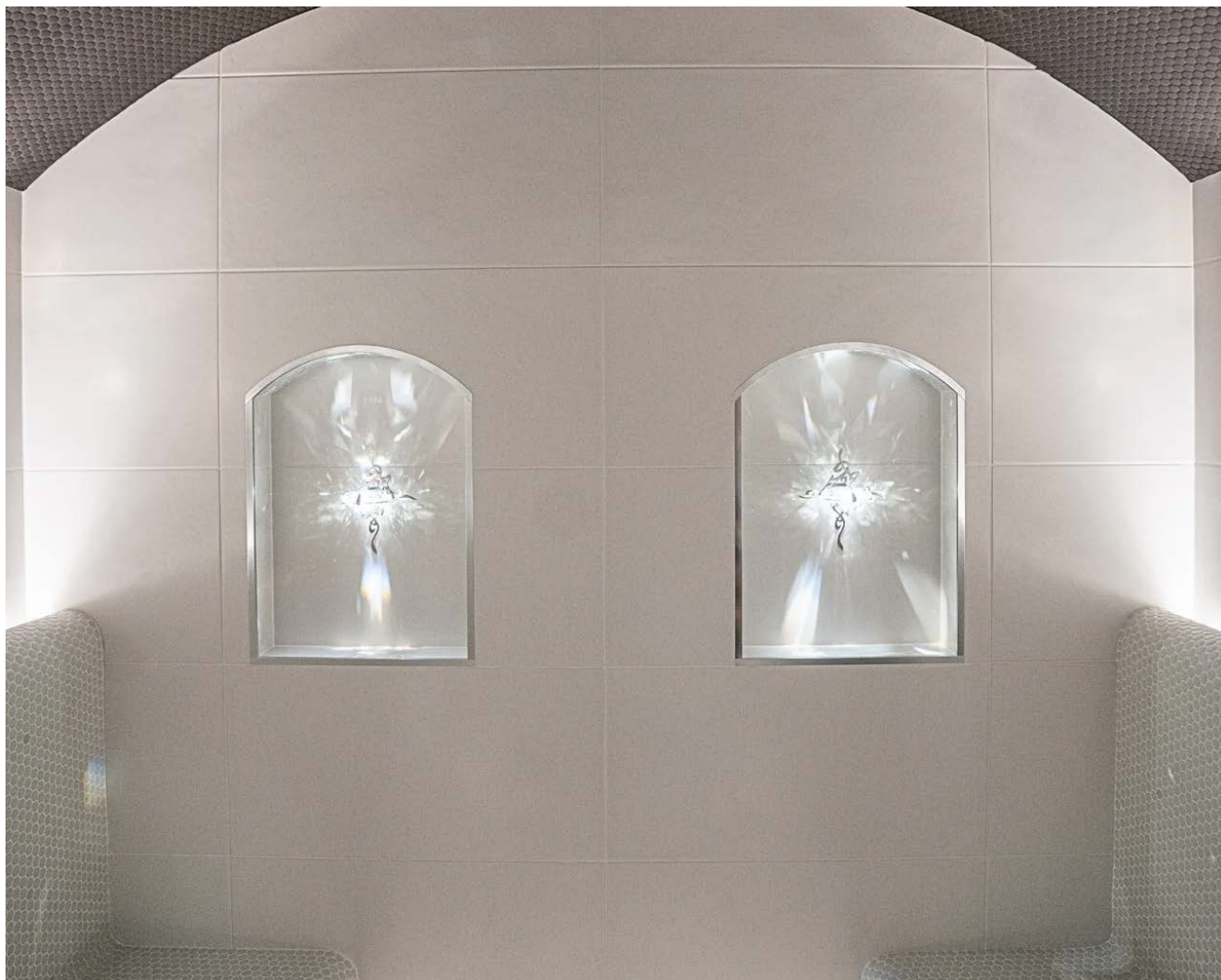

KIHLA GOLD

Code: 1545831

- Frame gold-plated brass
- Lead-free crystal
- L 175 mm x W 155 mm x H 94 mm

Design Frida Linström



KIHLA

Code: 1545830

- Frame stainless steel (AISI 304)
- Lead-free crystal
- L 175 mm x W 155 mm x H 94 mm

Design Frida Linström

PRODUCT INFORMATION

Suitable for use with fiber or LED. The recommended fiber size is Ø 4 mm, or one Cariitti LED.

NEO STEAM ROOM LIGHT

Neo IP67 (5W) is a ready-to-install steam room light



NEO IP67

Code: 1545243

- Gold
- 5 W / 150 mA / 3000 K / 474 lm
- Ra > 90
- Satin glass
- Diameter 74 mm
- Installing hole 50 mm
- Including connection cable 5 m
- Power supply included
- IP67



NEO IP67

Code: 1545244

- Chrome
- 5 W / 150 mA / 3000 K / 474 lm
- Ra > 90
- Satin glass
- Diameter 74 mm
- Installing hole 50 mm
- Including connection cable 5 m
- Power supply included
- IP67

PRODUCT INFORMATION

The Neo IP67 is a ready-to-install steam room light that includes a 5m connection cable and an OTI DALI power supply. Available in gold and chrome. With the help of an additional installation collar (1553022), an easy, waterproof installation is achieved during the construction.

TORCH LIGHT FITTING WITH ACRYLIC PIN

Torch with an acrylic pin is ideal for lighting in a steam room.



TORCH WITH ACRYLIC PIN

Code: 1545823

- Frame: stainless steel (AISI 304)
- Acrylic pin
- Satin glass
- Diameters: 175 x 83 x 43 mm

PRODUCT INFORMATION

Due to the acrylic pin, this fitting is not recommended for installation in a sauna.
Suitable for use with fiber or LED. The recommended fiber size is \varnothing 2-4 mm, or one Cariitti LED.



VOLITARE RGBW LED

Suitable for use with Cariitti's light fittings Lighthouse, Torch, Kihla and Lumi towel knob.



VOLITARE

Code: 1532494

- RGB+White 3000 K, 2.5 W/200 mA
- Serial connection
- Includes 5.2 m connection cable
- Power supply 1863032 to be ordered additionally
- IP67

PRODUCT INFORMATION

Suitable for use with Cariitti's light fittings Lighthouse, Torch, Kihla and Lumi towel knob. Can also be connected to other products on request.



SY WALL LIGHT FITTING

A wall mounted light fitting SY, mostly used in steam rooms, illuminates in one direction. Can be installed to illuminate either up or down.



SY WALL LIGHT FITTING

Code: 1545032

- Gold (gold-plated brass)



SY WALL LIGHT FITTING

Code: 1545030

- Stainless steel (AISI 304)



SY WALL LIGHT FITTING SQ

Code: 1545076

- Gold (gold-plated brass)



SY WALL LIGHT FITTING SQ

Code: 1545075

- Stainless steel (AISI 304)

PRODUCT INFORMATION

Suitable for use with fiber or LED. The recommended fiber size is Ø 4 mm, or one Cariitti LED.

SX WALL LIGHT FITTING

A wall mounted light fitting SX, mostly used in steam rooms, illuminates up and down. Suitable for use with fibers or LEDs.

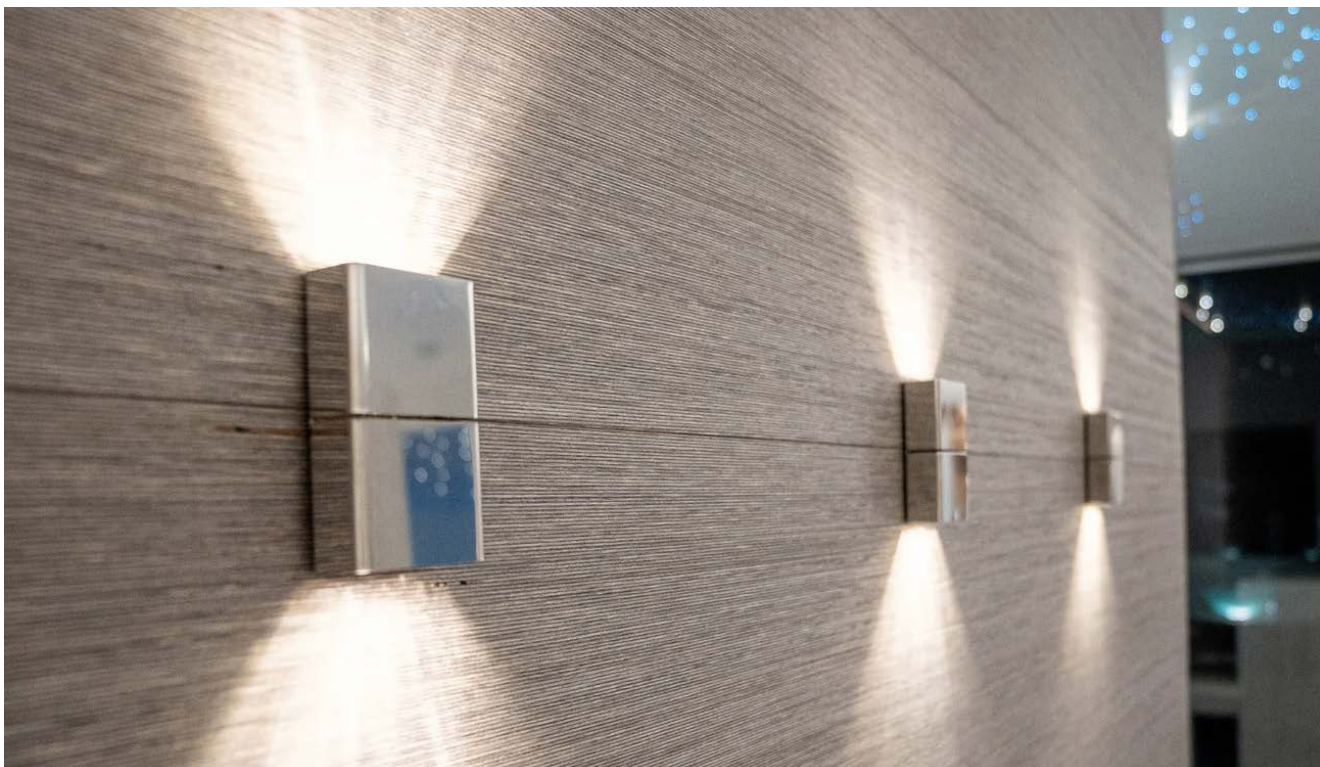

SX WALL LIGHT FITTING

Code: 1545035

- Gold (gold-plated brass)



SX WALL LIGHT FITTING

Code: 1545034

- Stainless steel (AISI 304)



SX WALL LIGHT FITTING SQ

Code: 1545078

- Gold (gold-plated brass)



SX WALL LIGHT FITTING SQ

Code: 1545077

- Stainless steel (AISI 304)

PRODUCT INFORMATION

Suitable for use with fibers or LEDs. The recommended fiber size is 2 x Ø 4 mm, or 2 pcs Cariitti LEDs.

S-PAVER STEAM ROOM LIGHT

A stylish LED light that is ideal for lighting a steam room



S-PAVER 3200 GOLD

Code: 1545217

- Equipped with a 5.2 m connection cable with IP67 connector
- Warm LED 1 W / 350 mA
- Serial connection
- Installing hole Ø 36 mm
- IP 68



S-PAVER RGBW 3200 GOLD

Code: 1553044

- Equipped with a 5.2 m connection cable with IP67 connector
- RGBW 2.5 W/200 mA
- Serial connection
- Installing hole Ø 36 mm
- IP 68

PRODUCT INFORMATION

S-Paver 3200 gold is ideal for lighting a steam room. The light fitting comes with both a clear and satin lens. The product is illuminated with a 1 W LED with a warm white light (3000 K). A power supply to be ordered separately.

S-Paver RGBW 3200 gold is ideal for lighting a steam room. The light fitting comes with both a clear and satin lens. The power supply 1863032 to be ordered separately.

S-PAVER LED COLOR

LED light for lighting a steam room and pool



S-PAVER RGBW 3200 LED

Code: 1553042

- Equipped with a 5.2 m connection cable with IP67 connector
- RGBW 2.5 W/200 mA
- Serial connection
- Installing hole Ø 36 mm
- Material acid-proof steel (AISI 316L)
- IP 68



S-PAVER RGBW 3300 LED

Code: 1553043

- Equipped with a 5.2 m connection cable with IP67 connector
- RGBW 2.5 W/200 mA
- Serial connection
- Installing hole Ø 36 mm
- External thread
- Material acid-proof steel (AISI 316L)
- IP 68

PRODUCT INFORMATION

S-Paver RGBW 3200 is ideal for a steam room and pool lighting. All S-Paver lights are supplied with both a clear and satin lens. The power supply 1863032 to be ordered separately.

S-Paver RGBW 3300 is ideal for lighting a steam room. The light fitting comes with both a clear and satin lens. The power supply 1863032 to be ordered separately.

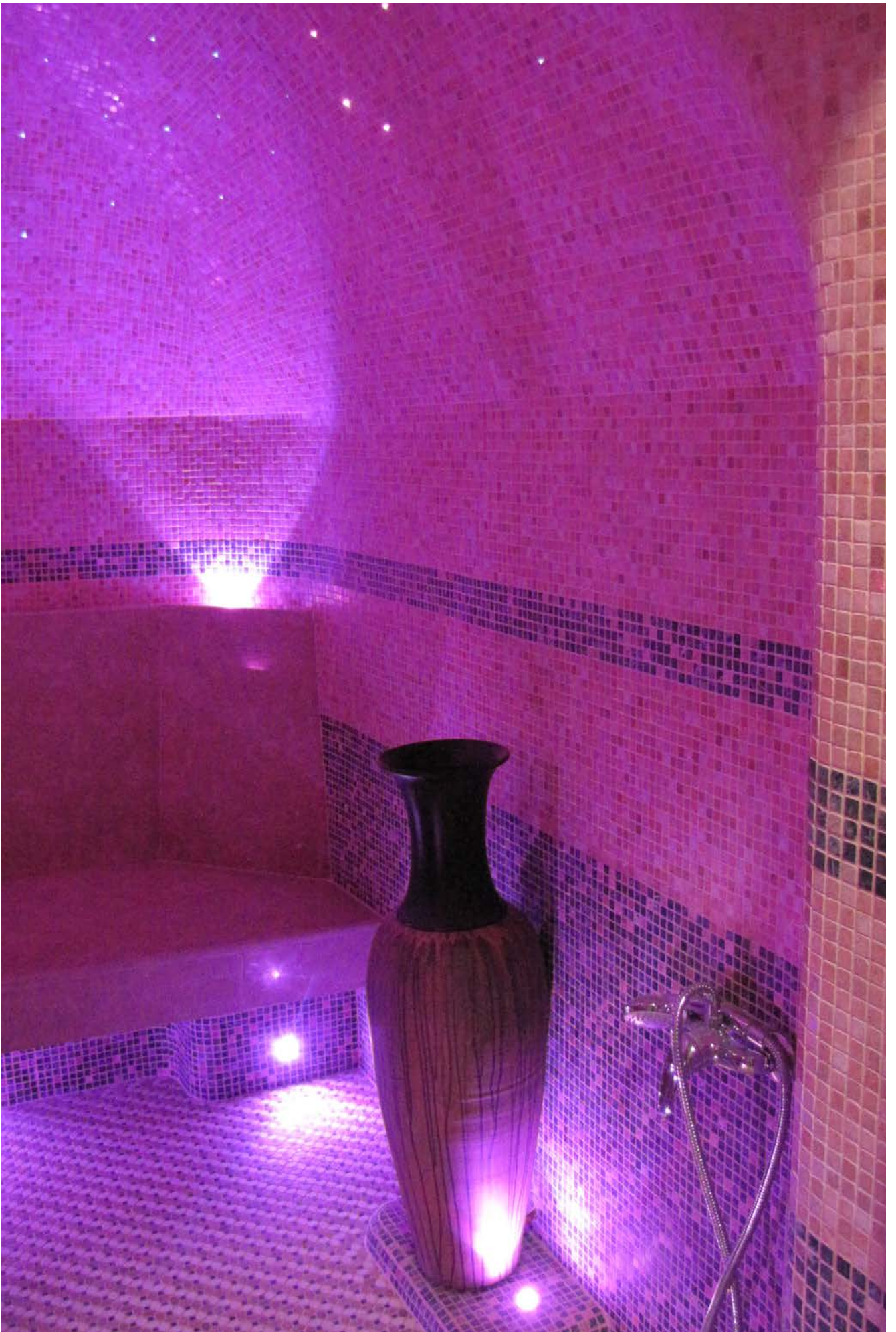

BATHROOM LIGHTING

Bathroom lighting is one of the biggest factors when it comes to bathroom comfort. Bathroom facilities have long been designed for relaxation and are now becoming real pampering centers. This trend can also be seen in Finland, and even more so in Central Europe, where a lot of investment is being made in these facilities. Instead of traditional lamps, crystal lights and towel hooks designed specifically for bathrooms and spas can serve as bathroom lighting, as well as products that have been specially developed to highlight recesses and floor surfaces.





HALO GLASS BASIN

The glass basin is made of tempered glass and the surface of the basin is satin matte glass, allowing the light to spread evenly and beautifully.



HALO GLASS BASIN

Code: 1545672

- Ø 380 mm
- LEDs serve as light sources
- Max. power 3,5 W
- IP67
- Includes a power supply (IP20)



TOIVE CRYSTAL LIGHT

TOIVE is a modern crystal sconce, which is both a decoration and a light.

The light reflected through the crystals forms beautiful and exciting patterns on the wall.



TOIVE

Code: 1527844

- Clear acryl
- Chrome-plated aluminum
- 2 x 1 W / 350 mA / 4000K
- Lead-free crystal
- Power supply included, equipped with a 5 m cable
- IP44

Design: Frida Lindström 2008



PRODUCT INFORMATION

TOIVE is ideal for both private and public premises: in lounges, hallways or in a bedroom above the bedside tables.

CLARA SPOT LIGHT

Clara is a dimmable downlight spot. The color temperature adjusts from a cold 4000K to a warm 2200K which creates an excellent opportunity to change the atmosphere of the space according to the need for light.



CLARA (white)

Code: 1554517

- Dimmable, 550 lm
- Color temperature 4000 – 2200 K
- 8 W, 220 – 240 V
- Ra > 90
- Light opening angle 40°
- Tilted
- Material: aluminium
- Diameter Ø 95 mm
- Recess 47 mm
- Installing hole Ø 83 mm
- Power supply included
- IP44



CLARA (chrome)

Code: 1554518

- Dimmable, 550 lm
- Color temperature 4000 – 2200 K
- 8 W, 220 – 240 V
- Ra > 90
- Light opening angle 40°
- Tilted
- Material: aluminium
- Diameter Ø 95 mm
- Recess 47 mm
- Installing hole Ø 83 mm
- Power supply included
- IP44



CLARA (black)

Code: 1554519

- Dimmable, 550 lm
- Color temperature 4000 – 2200 K
- 8 W, 220 – 240 V
- Ra > 90
- Light opening angle 40°
- Tilted
- Material: aluminium
- Diameter Ø 95 mm
- Recess 47 mm
- Installing hole Ø 83 mm
- Power supply included
- IP44

PRODUCT INFORMATION

Clara is an adjustable spotlight, tilting 25° in all directions. Can be dimmed directly from the supply voltage.

ARCTIC SKY CRUSHED GLASS PANEL

Crushed glass panel is like a painting. Depending on the chosen projector you can create effects like fire flame, northern lights or color change. With clear white light the panel looks like crushed ice. A dashing and therapeutic element that changes character according to the chosen light effect.

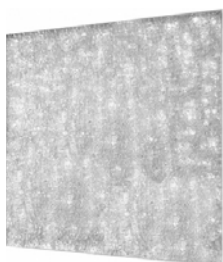
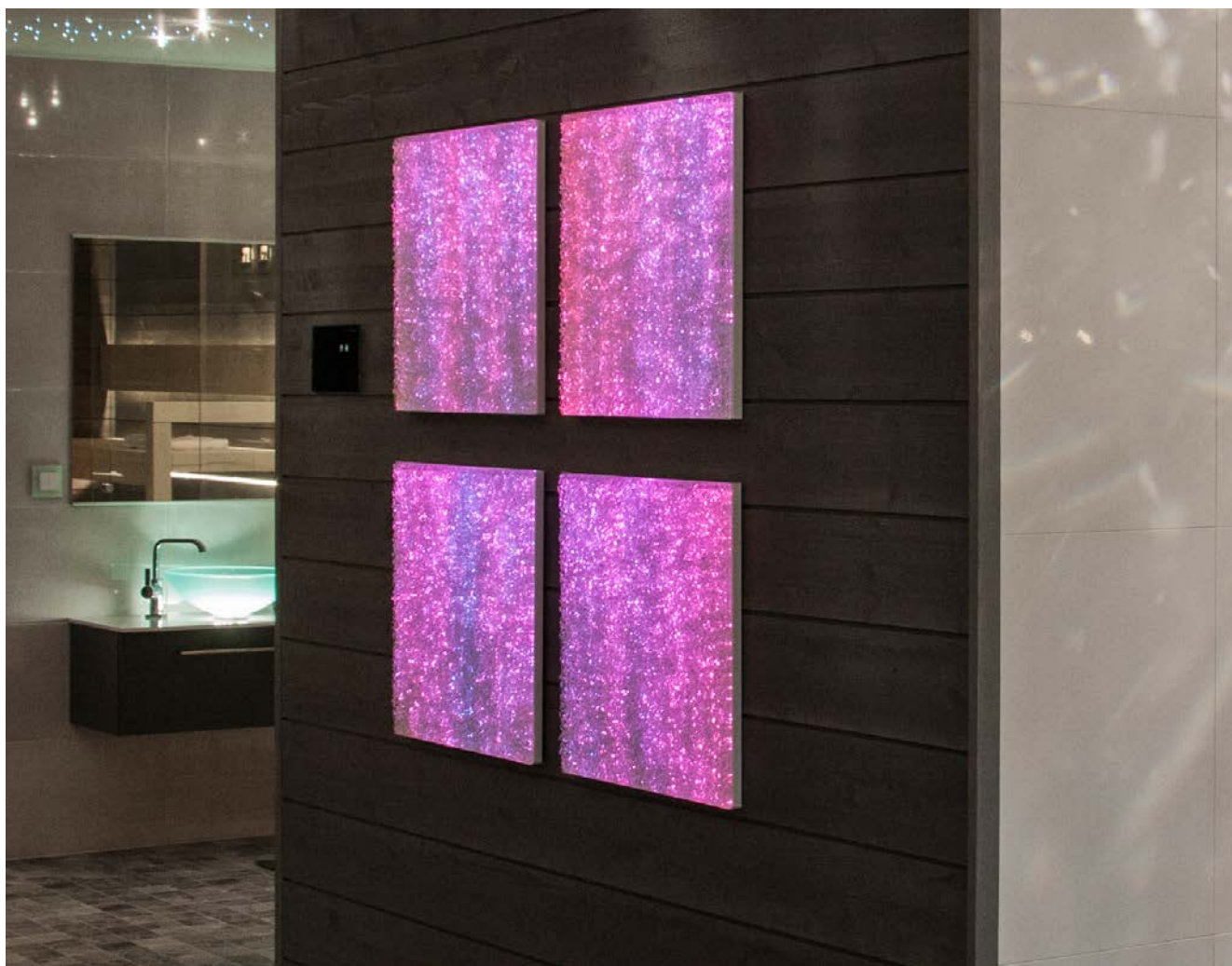

ARCTIC SKY

Code: 1589030

- Size: 500 x 500 x 30 mm
- Can be illuminated with one 6 mm fiber or LED

Not suitable for a sauna.

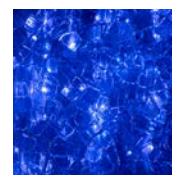
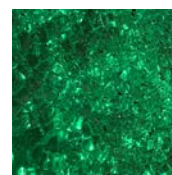
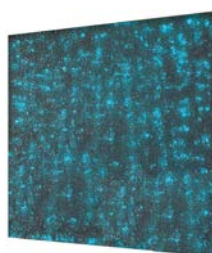

ARCTIC SKY RGBW

Code: 1589026

- RGBW 2.5 W/200 mA
- Serial connection
- IP44
- Power supply to be ordered separately: 1532495, 1532590

Not suitable for a sauna.

PRODUCT INFORMATION

Can be illuminated with one 6 mm fiber or LED, installed in the middle of the panel. You can even place multiple elements on top of each other or side by side.

LUMI ILLUMINATED TOWEL HOOK

A splendid detail in your bathroom!



LUMI TOWEL HOOK

Code: 1545552

- Can be illuminated with a 4 mm fiber or an LED
- Stainless steel
- Satin glass
- Installing hole Ø 12 mm

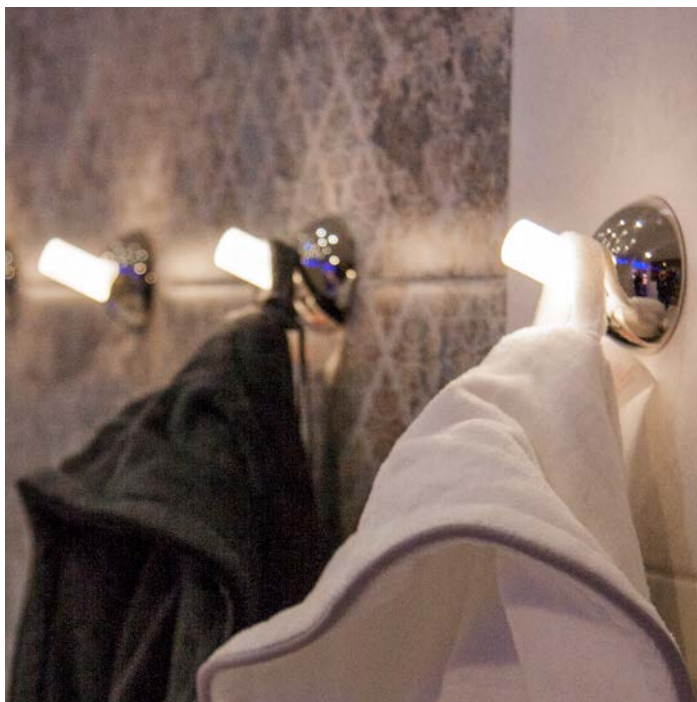

SADE CRYSTAL FITTING

The light consists of three crystal chains of different lengths.

SADE crystal fittings can be used with all Cariitti LED lighting sets.



SADE 345

Code: 1545833

- Chain lengths: 150 / 185 / 215 mm
- Lead-free crystal
- The set includes one crystal fitting
- Installing hole Ø 12 mm
- Recess 20 mm



SADE 567

Code: 1545835

- Chain lengths: 215 / 250 / 285 mm
- Lead-free crystal
- The set includes one crystal fitting
- Installing hole Ø 12 mm
- Recess 20 mm

PRODUCT INFORMATION

The light source of SADE must be ordered separately, we recommend the color temperature 4000 K with crystals.

POOL LIGHTING

Pool lighting can be implemented in many ways. Traditionally, S-Paver lights are installed on the edges of the pool in either a fiber optic or LED option. Swimming pools are often illuminated with colors. Especially when using colors, the LED option gives a stronger light than optical fiber.

Pool lights can also be implemented outside the pool. The starry sky installed on top of the pool, mounted on the ceiling, is beautifully mirrored from the surface of the pool water. Lighting the wall surfaces of the pool area with various effects, as Northern Lights or Fire Flame, also creates a beautiful and peaceful atmosphere.





PORE BALL LIGHT

PORE is an LED light with wireless charging. PORE is a safe choice when you want to create a relaxed and pleasant atmosphere indoors, outdoors or by the water.

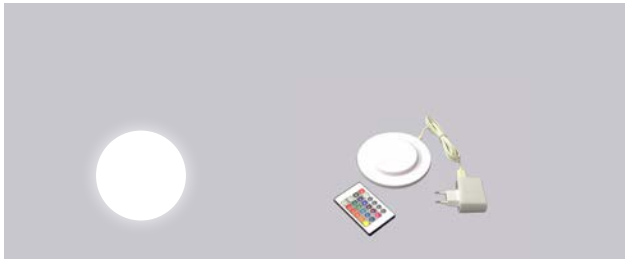

PORE 2.0

Code: 1532505

- Ø 20 cm
- Battery: Lithium 3.7 V / 1000 mA, rechargeable
- 3000 K
- Transformer: Input voltage AC100-240 V, output voltage DC 5 V
- Certifications: CE / GS / UL / PSE
- Charger: Inductive charging with USB cable
- 6 bright RGBW LEDs
- Colors: 16 color options and color change mode
- Charging / Operating time: 4 h / 8 h
- Controls: Bottom switch / 24-function remote control
- IP67
- Material: White UV-protected PE plastic

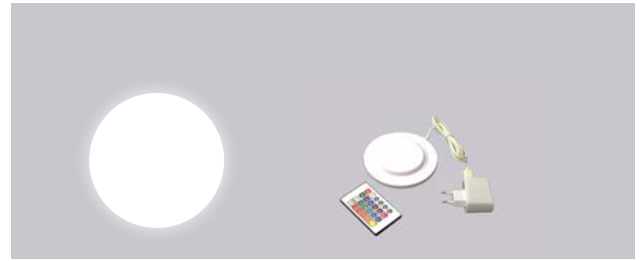

PORE 3.0

Code: 1532506

- Ø 30 cm
- Battery: Lithium 3.7 V / 1000 mA, rechargeable
- 3000 K
- Transformer: Input voltage AC100-240 V, output voltage DC 5 V
- Certifications: CE / GS / UL / PSE
- Charger: Inductive charging with USB cable
- 6 bright RGBW LEDs
- Colors: 16 color options and color change mode
- Charging / Operating time: 4 h / 8 h
- Controls: Bottom switch / 24-function remote control
- IP67
- Material: White UV-protected PE plastic

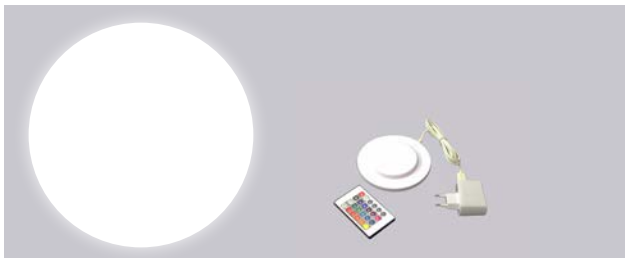

PORE 5.0

Code: 1532507

- Ø 50 cm
- Battery: Lithium 3.7 V / 1000 mA, rechargeable
- 3000 K
- Transformer: Input voltage AC100-240 V, output voltage DC 5 V
- Certifications: CE / GS / UL / PSE
- Charger: Inductive charging with USB cable
- 6 bright RGBW LEDs
- Colors: 16 color options and color change mode
- Charging / Operating time: 4 h / 8 h
- Controls: Bottom switch / 24-function remote control
- IP67
- Material: White UV-protected PE plastic

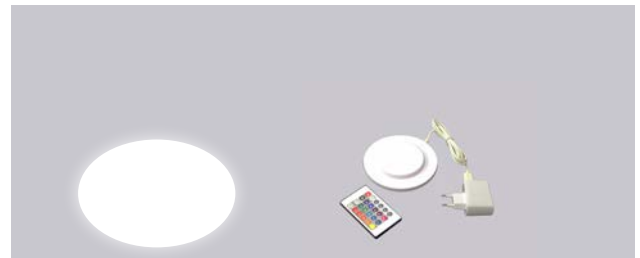

PORE 35/20

Code: 1532508

- Ø 35x20 cm
- Battery: Lithium 3.7 V / 1000 mA, rechargeable
- 3000 K
- Transformer: Input voltage AC100-240 V, output voltage DC 5 V
- Certifications: CE / GS / UL / PSE
- Charger: Inductive charging with USB cable
- 6 bright RGBW LEDs
- Colors: 16 color options and color change mode
- Charging / Operating time: 4 h / 8 h
- Controls: Bottom switch / 24-function remote control
- IP67
- Material: White UV-protected PE plastic

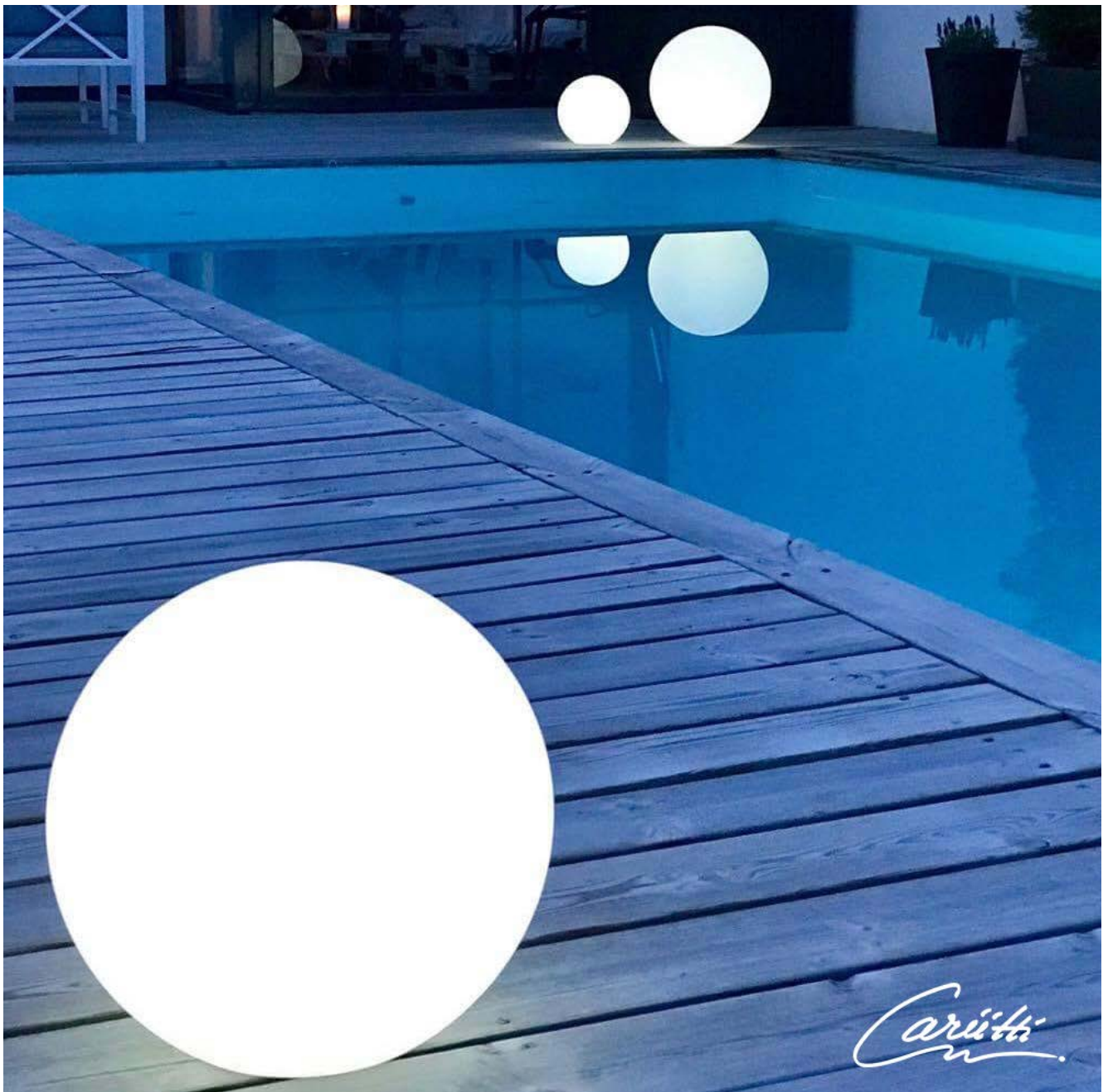

PRODUCT INFORMATION

With the new integrated battery and charging system of the PORE ball light, the luminaire has been made lightweight, easy and versatile. The light source of the product is RGBW LEDs, the colors and intensity of which you can adjust with the included remote control. You can choose your favourite from four different sizes: Ø 20 cm, Ø 30 cm, Ø 50 cm and Ø 35x20 cm. **For larger projects, ask for other sizes as well.**

S-PAVER 3200 LED

The light fitting is suitable for outdoor and underwater use.

Popular applications include driveways, garden paving, various pool facilities, jacuzzis and swimming pools.



LED S-PAVER 3200

Code: 1553034

- Light source 1W – 350mA SMD LED
- Equipped with a 5 m connection cable
- Material acid-proof steel (AISI 316L)
- Serial connection
- IP 68



LED S-PAVER 3300

Code: 1553037

- Light source 1W – 350mA SMD LED
- Equipped with a 5 m connection cable
- Material acid-proof steel (AISI 316L)
- Serial connection
- IP 68

S-PAVER FOR OPTIC FIBER

The light fitting is suitable for outdoor and underwater use.

Popular applications include driveways, garden paving, various pool facilities, jacuzzis and swimming pools.



S-PAVER 3200 for optic fiber

Code: 1553008

- Recommended optic fiber size 4-6 mm
- Smooth base



S-PAVER 3300 for optic fiber

Code: 1553010

- Recommended optic fiber size 4-6 mm
- Thread base



Photo: Poolexpert, Greece

PRODUCT INFORMATION

The Led S-Paver light fitting is made of acid-proof steel (AISI 316L). The light fitting comes with both a clear and light-diffusing satin lens.

RECOMMENDED POWER SUPPLIES

S-Paver 3200 and 3300 LED:

For white light: 1532449, 1532442

N.B! Series connection only.

For S-Paver 3200 and 3300 optical fiber:

Projector and fiber harness must be ordered separately.

Recommended fiber size 4-6 mm.

S-Paver 3200 - installation:

There are several options for installing the fitting. A popular way is to use similar plastic parts as in the construction of water supply networks, such as PP32-S14 and PP32-S16. This part can be installed as a reservation for the S-Paver fitting, for example, in concrete casting and plugged with a PP32-S16 plug. When the casting has dried, remove the plug and install the fitting in place. The end result is a watertight connection.

S-Paver 3300 - installation:

The installation of the fitting is done with the help of a clamping nut of the fitting. The included silicone sealing ring is installed under the flange of the fitting and the nut is tightened at the back. This model with thread lock is particularly suitable for various pool installations.

CHANDELIERS AND SPACE DIVIDERS

With Kimmel fiber optic chandeliers and Pirta curtains, you can create an impressive eye-catcher or space divider in the room.





KIMMEL

Spiral-shaped fiber chandelier

KIMMEL 1

Code: 1527810

- Height: 180 cm
- Ø 56 cm
- Weight: 12 kg
- Crystals: 150 pcs

KIMMEL 2

Code: 1527811

- Height: 250 cm
- Ø 66 cm
- Weight: 14 kg
- Crystals: 200 pcs

KIMMEL 3

Code: 1527812

- Height: 350 cm
- Ø 66 cm
- Weight: 26 kg
- Crystals: 200 pcs

KIMMEL 4

Code: 1527813

- Height: 350 cm
- Ø 98 cm
- Weight: 33 kg
- Crystals: 250 pcs

KIMMEL 5

Code: 1527814

- Height: 450 cm
- Ø 98 cm
- Weight: 35 kg
- Crystals: 250 pcs



PRODUCT INFORMATION

The fiber optic chandelier is a ready-to-install luminaire in which the fibers are mounted on the frame of the luminaire and the crystals on the ends of the fibers. As the light sources serve the LED projectors integrated in the luminaire frame.

PIRTA

Pirta curtain is a ready-to-install luminaire in which the fibers are mounted on the frame of the luminaire and the crystals on the ends of the fibers.

PIRTA 0.8

Code: 1527827

- Height: 200 cm
- Width 80 cm
- Weight: 18 kg
- Crystals: 80 pcs Ø 30 mm

PIRTA 1.2

Code: 1527826

- Height: 200 cm
- Width 120 cm
- Weight: 27 kg
- Crystals: 120 pcs Ø 30 mm

PIRTA 1.6

Code: 1527829

- Height: 200 cm
- Width 160 cm
- Weight: 34 kg
- Crystals: 160 pcs Ø 30 mm



PRODUCT INFORMATION

As the light sources serve the LED projectors integrated in the luminaire frame.

Pirta can be mounted to the ceiling or wall. The fastening method must be specified when ordering.

LED PROFILES AND INDIRECT LIGHTING

Cariitti LED lights are particularly well-suited for indirect illumination and kitchen lighting. The lights can be installed in kitchen units and their advantages include low heat generation and energy consumption as well as a long lifetime.

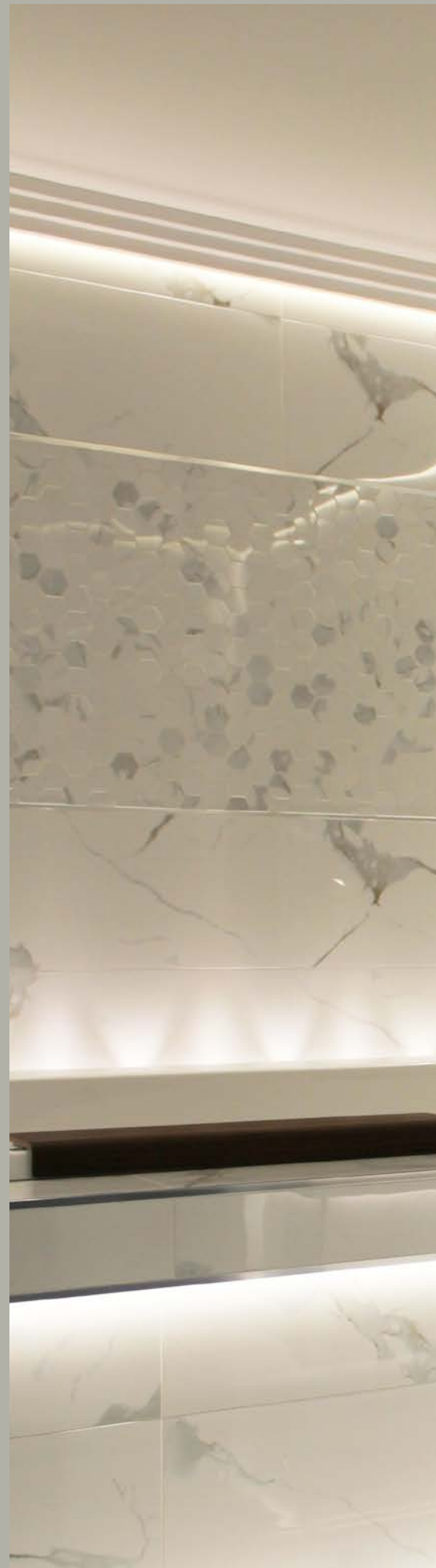



HUUHTO EASY LED PROFILE

Huuhto Easy LED profile lights are suitable for a diverse use. They can be used for indirect lighting through ceiling surface and they suit particularly well for illuminating the space between kitchen units.

HUUHTO EASY 330 MM 5W

Code: 1532450

- Length 330 mm, Width 18 mm, Height 16 mm
- 24 V / 5 W
- 3000 K
- 278 lm
- IP44

HUUHTO EASY 330 MM 5W

Code: 1532456

- Length 330 mm, Width 18 mm, Height 16 mm
- 24 V / 5 W
- 4000 K
- 315 lm
- IP44

HUUHTO EASY 520 MM 8W

Code: 1532451

- Length 520 mm, Width 18 mm, Height 16 mm
- 24 V / 8 W
- 3000 K
- 470 lm
- IP44

HUUHTO EASY 520 MM 8W

Code: 1532457

- Length 520 mm, Width 18 mm, Height 16 mm
- 24 V / 8 W
- 4000 K
- 534 lm
- IP44

HUUHTO EASY 620 MM 10W

Code: 1532452

- Length 620 mm, Width 18 mm, Height 16 mm
- 24 V / 10 W
- 3000 K
- 547 lm
- IP44

HUUHTO EASY 620 MM 10W

Code: 1532458

- Length 620 mm, Width 18 mm, Height 16 mm
- 24 V / 10 W
- 4000 K
- 621 lm
- IP44

HUUHTO EASY 1000 MM 16W

Code: 1532453

- Length 1000 mm, Width 18 mm, Height 16 mm
- 24 V / 16 W
- 3000 K
- 945 lm
- IP44

HUUHTO EASY 1000 MM 16W

Code: 1532459

- Length 1000 mm, Width 18 mm, Height 16 mm
- 24 V / 16 W
- 4000 K
- 1073 lm
- IP44

HUUHTO EASY 1480 MM 24 W

Code: 1532454

- Length 1480 mm, Width 18 mm, Height 16 mm
- 24 V / 24 W
- 3000 K
- 1417 lm
- IP44

HUUHTO EASY 1480 MM 24 W

Code: 1532460

- Length 1480 mm, Width 18 mm, Height 16 mm
- 24 V / 24 W
- 4000 K
- 1607 lm
- IP44

HUUHTO EASY 1960 MM 32W

Code: 1532455

- Length 1960 mm, Width 18 mm, Height 16 mm
- 24 V / 32 W
- 3000 K
- 1890 lm
- IP44

HUUHTO EASY 1960 MM 32W

Code: 1532461

- Length 1960 mm, Width 18 mm, Height 16 mm
- 24 V / 32 W
- 4000 K
- 2147 lm
- IP44

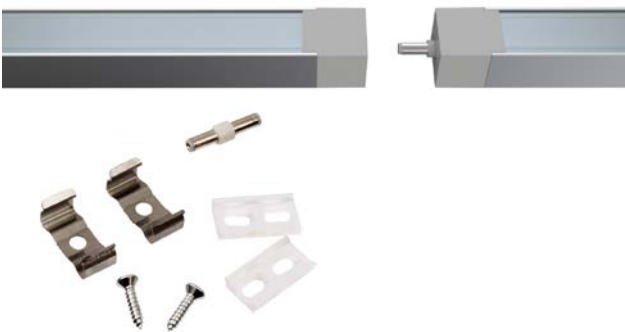

PRODUCT INFORMATION

Huuhto Easy is available in six lengths which can be freely connected for the required length of light. The profiles are connected to each other directly or with enclosed connectors. The profiles are fastened invisibly on the installation surface with enclosed clips. The satin cover reduces the LED spot effect to the minimum. The power supply to be ordered separately, see page 137: items 1863036; 1863037.

CORNER PIECE 90 DEGREES HUUHTO EASY

The corner piece is used in HUUHTO Easy lights, particularly in corner installations.

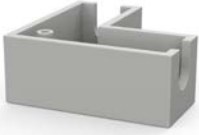

CORNER PIECE 90 DEGREES

Code: 1532362

- Dimensions 52 x 52 mm

CONNECTION WIRE 100 MM HUUHTO EASY

The connection wire is used in HUUHTO Easy lights, particularly in corner installations.



CONNECTION WIRE 100 MM

Code: 1532363

- Total length 100 mm
- Cable length 25 mm

SUPPLY CABLE 5M HUUHTO EASY

Supply cable for HUUHTO Easy -profiles.



SUPPLY CABLE 5M

Code: 1532118

- Length 5 m

SUPPLY CABLE 5M WITH 90 DEGREES ANGLE HUUHTO EASY

Supply cable for HUUHTO Easy -profiles.



SUPPLY CABLE 5M WITH 90 DEGREES ANGLE

Code: 1532133

- Length 5 m
- with 90° angle

ADJUSTMENT FITTINGS, HUUHTO EASY

Adjustment fittings are used in HUUHTO Easy lights particularly in indirect lighting. The light is easy to focus with adjustment fittings.



ADJUSTMENT FITTINGS, A PAIR

Code: 1532361



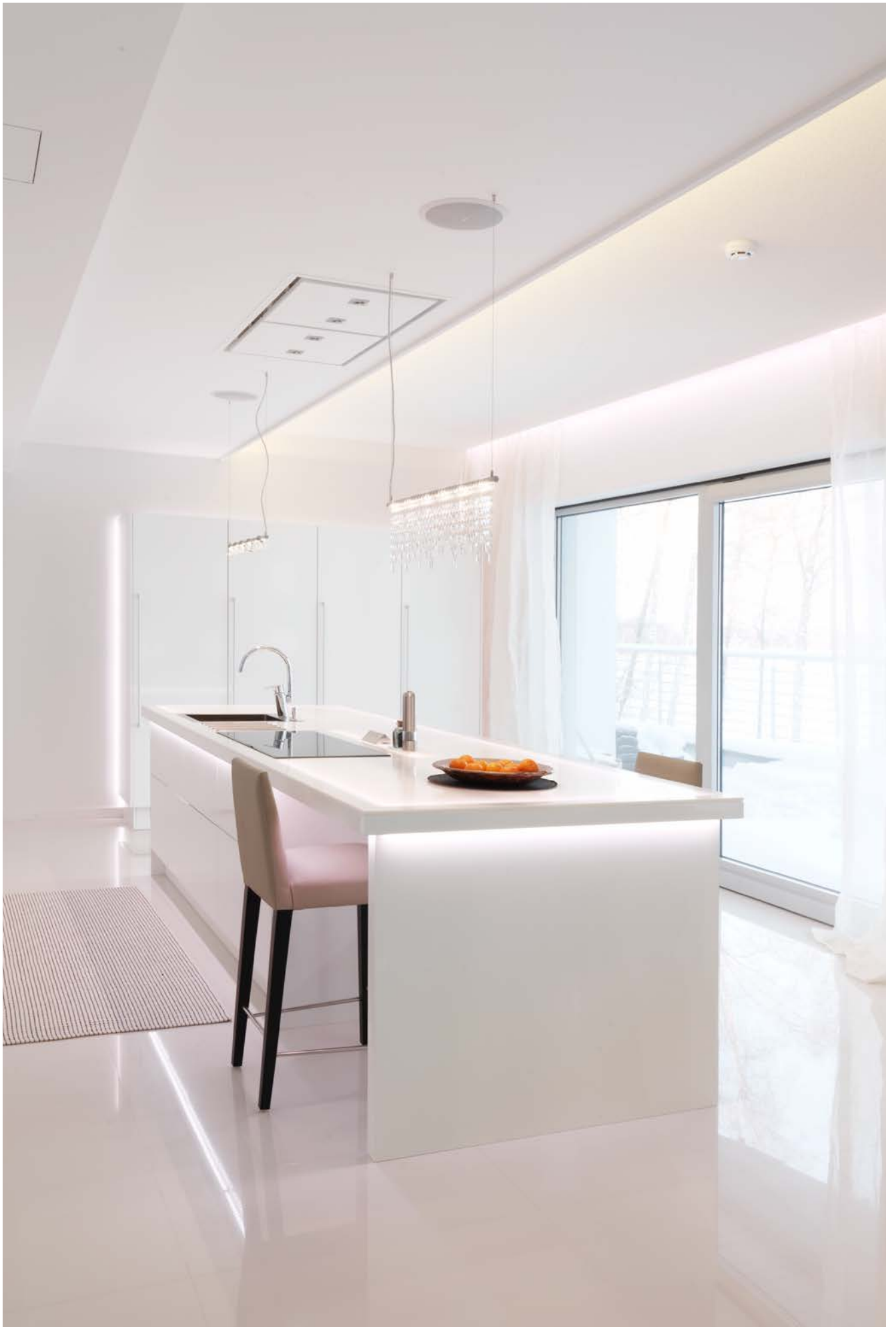



PROJECTORS

Among the range of Cariitti projectors you will easily find a model to suit your own lighting solutions and type of installation.

All our projectors are equipped with an LED light source. This ensures the excellent light quality and long lifetime. The product range includes also RGBW projectors with color change, as well as projectors with various effects.

VPAC LED PROJECTORS



VPAC27

Code: 1801001

- 2700 K
- 230V
- 16.5 W
- 1500 lm, Ra > 90
- P 145 x L 150 x K 83
- LED, 50.000h
- Mains dimming
- IP65
- Weight 1,03 kg



VPAC30

Code: 1801002

- 3000 K
- 230V
- 16.5 W
- 1500 lm, Ra > 90
- P 145 x L 150 x K 83
- LED, 50.000h
- Mains dimming
- IP65
- Weight 1,03 kg



VPAC40

Code: 1801003

- 4000 K
- 230V
- 16.5 W
- 1500 lm, Ra > 90
- P 145 x L 150 x K 83
- LED, 50.000h
- Mains dimming
- IP65
- Weight 1,03 kg

PRODUCT INFORMATION

The **VPAC27/30/40 LED projectors** are suitable for use with both glass and plastic fibers. The projector has a protection class IP65 and it can also be installed in the sauna, under the benches.

Can be dimmed directly from the supply voltage. The mounting hole of the fiber harness is \varnothing 30 mm. When installed in the sauna, the installation height is max 80 cm from the floor.

VPL 30X DALI



VPL 30X L DALI

Code: 1501524

- 3000 K
- 230V, 33 W, 500 mA
- 1380 lm
- IP65/IP21
- P 145 x L 150 x K 83
- LED, 50.000h
- Electronic power supply
- Dimming with DALI / push-button
- Weight 1.5 kg



VPL 30X K DALI

Code: 1501525

- 4000 K
- 230V, 33 W, 500 mA
- 1380 lm
- IP65/IP21
- P 145 x L 150 x K 83
- LED, 50.000h
- Electronic power supply
- Dimming with DALI / push-button
- Weight 1.5 kg

PRODUCT INFORMATION

The **VPL30 X DALI LED projector** is suitable for both glass and plastic fibers. The projector unit has a protection class IP65 and the driver has IP21.

When installed in a sauna, the installation height of the projector unit is max 40 cm from the floor. The power supply (incl. 5.2 m cable) must be installed in a dry place. The mounting hole of the fiber harness is \varnothing 30 mm.



VPL 10 X

Code: 1501412

- 3000 K
- 230 V / 5 W / 700 mA /
- IP55
- Led, 50.000 h
- Electronic power supply
- Non-dimmable
- Dimensions: Ø 30 mm, length 80 mm, mounting box 130 x 85 mm
- Weight 0.3 kg

PRODUCT INFORMATION

When installed in a sauna, the installation height is max 80 cm from the floor.

Max 75 pcs 0,75 mm fiber strands.
The mounting hole of the fiber harness is Ø 16 mm.



VPL 10

Code: 1801019

- 2700 K
- 230 V / 1.7 W / 350 mA / IP55
- Led, 50.000 h
- Electronic power supply
- Non-dimmable
- Dimensions: Ø 30 mm, length 80 mm, mounting box 130 x 85 mm
- Weight 0.3 kg

PRODUCT INFORMATION

When installed in a sauna, the installation height is max 80 cm from the floor.

Max 75 pcs 0,75 mm fiber strands.
The mounting hole of the fiber harness is Ø 16 mm.



VPL10UV

Code: 1501795

- 230 V / 1.7 W / 350 mA / IP55
- Led, 425 - 430 nm
- UV light
- Electronic power supply
- Non-dimmable
- Weight 0.3 kg

PRODUCT INFORMATION

LED projector with UV light. When installed in a sauna, the installation height is max 80 cm from the floor.

Max 75 pcs 0,75 mm fiber strands.
The mounting hole of the fiber harness is Ø 16 mm.



VPL30UV

Code: 1501796

- 230 V / 30 W / 230 mA
- UV-led, 425 - 430 nm
- P 250 x L 150 x K 83
- Electronic power supply
- Dimming 1 - 10 V
- IP65
- Weight 2.7 kg
- Fiber harness mounting hole Ø 30 mm

PRODUCT INFORMATION

LED projector with UV light.

When installed in a sauna, the installation height is max 40 cm from the floor.



VPL30 TW 2700-6500K

Code: 1801018

- 2700 - 6500 K
- 230V / 17 W / 2000 lm
- P 250 x L 150 x K 83
- Electronic power supply
- DALI control
- IP65
- Weight 2.5 kg
- Fiber harness mounting hole Ø 30 mm

PRODUCT INFORMATION

The VPL30 TW LED projector is suitable for both glass and plastic fibers. The projector has an IP65 protection rating. The white color temperature is tunable 2700-6500 K.

When installed in a sauna, the installation height is max 40 cm from the floor.
Ambient temperature (Ta) max 40°C.



VPL30XL 30 W IP65

Code: 1501487

- 3000 K
- 230 V / 26 W / 2600 lm
- P 250 x L 150 x K 83
- Electronic power supply
- Dimming 1-10 V
- IP65
- Weight 2,5 kg
- Fiber harness mounting hole Ø 30 mm

PRODUCT INFORMATION

The **VPL30 XL LED projector** is suitable for both glass and plastic fibers. The projector has an IP65 protection rating. Color temperature white 3000 K.

When installed in a sauna, the installation height is max 40 cm from the floor. Ambient temperature (Ta) max 40°C.



VPL30XK 30 W IP65

Code: 1501488

- 4000 K
- 230 V / 26 W / 2830 lm
- P 250 x L 150 x K 83
- Electronic power supply
- Dimming 1-10 V
- IP65
- Weight 2,5 kg
- Fiber harness mounting hole Ø 30 mm

PRODUCT INFORMATION

The **VPL30 XK LED projector** is suitable for both glass and plastic fibers. The projector has an IP65 protection rating. Color temperature white 4000 K.

When installed in a sauna, the installation height is max 40 cm from the floor. Ambient temperature (Ta) max 40°C.



VPL30 KT IP65

Code: 1501456

- 230 V, 13 W
- Kaleidoscope effect
- P 250 x L 150 x K 83
- Electronic power supply
- IP65
- Weight 2,5 kg
- Fiber harness mounting hole Ø 30 mm

PRODUCT INFORMATION

The **VPL30 KT LED projector** has a kaleidoscope effect with white, blue and cyan LEDs as the light source. Suitable for both glass and plastic fibers. The projector has a protection class IP65 and it can also be installed in a sauna, under the benches (max 80 cm from the floor).



VPL30 CT IP65

Code: 1501453

- 230 V, 13 W
- Blue Twinkle effect
- P 250 x L 150 x K 83
- Electronic power supply
- IP65
- Weight 2,5 kg
- Fiber harness mounting hole Ø 30 mm

PRODUCT INFORMATION

The **VPL30 CT LED projector** has a blue twinkle effect, which is implemented with blue and cyan-colored LEDs. Suitable for both glass and plastic fibers. The projector has a protection class IP65 and it can also be installed in a sauna, under the benches (max 80 cm from the floor).



VPL30 NL IP65

Code: 1501454

- 230 V, 13 W
- Northern Lights effect
- P 250 x L 150 x K 83
- Electronic power supply
- IP65
- Weight 2.5 kg
- Fiber harness mounting hole Ø 30 mm

PRODUCT INFORMATION

The VPL30 NL LED projector has the Northern Lights effect with changing colors blue, green and magenta. The effect is implemented with LEDs. Suitable for both glass and plastic fibers.

The projector has a protection class IP65 and it can also be installed in a sauna, under the benches (max 80 cm from the floor).



VPL30 FL IP65

Code: 1501455

- 230 V, 13 W
- Fire Flame effect
- P 250 x L 150 x K 83
- Electronic power supply
- IP65
- Weight 2.5 kg
- Fiber harness mounting hole Ø 30 mm

PRODUCT INFORMATION

The VPL30 FL LED projector has the Fire Flame effect with changing colors orange, yellow and amber. The effect is implemented with LEDs. Suitable for both glass and plastic fibers.

The projector has a protection class IP65 and it can also be installed in a sauna, under the benches (max 80 cm from the floor).



VPL 30 T with control

Code: 1801021

- 230 V
- White Twinkle 4000 K
- P 145 x L 150 x K 83
- Electronic power supply
- IP65/IP20
- Weight 1.5 kg
- Fiber harness mounting hole Ø 30 mm

PRODUCT INFORMATION

LED projector with white twinkle. Suitable for both glass and plastic fibers. The projector has wireless control. Control with the included wireless switch.

You can also download the controller app on iPhone, iPad, or Android devices. With the app, you can control the twinkle, its speed and brightness.



VPL 30 T with control

Code: 1801023

- 230 V
- White Twinkle 2700 K
- P 145 x L 150 x K 83
- Electronic power supply
- IP65/IP20
- Weight 1.5 kg
- Fiber harness mounting hole Ø 30 mm

PRODUCT INFORMATION

LED projector with white twinkle. Suitable for both glass and plastic fibers. The projector has wireless control. Control with the included wireless switch.

You can also download the controller app on iPhone, iPad, or Android devices. With the app, you can control the twinkle, its speed and brightness.



RGBW-BLE with color change

Code: 1801007

- 230 V, 10 W
- P 145 x L 150 x K 83
- Electronic power supply
- IP65/IP20
- RGB + W 7600 K

PRODUCT INFORMATION

RGBW color-changing projector with wireless control based on the Casambi app.

You can download the control app on your iPhone, iPad or Android devices. You can use the app to control the projector's colors and brightness.



RGBW-BLE with color change and control switch

Code: 1801008

- 230 V, 10 W
- P 145 x L 150 x K 83
- Electronic power supply
- IP65/IP20
- RGB + W 7600 K
- Wireless control switch

PRODUCT INFORMATION

RGBW color-changing projector with wireless control based on the Casambi app. Control with the included wireless switch.

You can download the control app on your iPhone, iPad or Android devices. You can use the app to control the projector's colors and brightness.



RGBW-DALI

Code: 1801009

- 230 V, 19 W
- P 145 x L 150 x K 83
- Electronic power supply
- IP65/IP20
- RGB + W 7600 K
- Weight 1,6 kg

PRODUCT INFORMATION

RGBW projector with DALI-controlled driver.



RGBW-DMX

Code: 1801010

- 230 V, 19 W
- P 145 x L 150 x K 83
- Electronic power supply
- IP65/IP20
- RGB + W 7600 K
- Weight 1,6 kg

PRODUCT INFORMATION

RGBW projector with DMX-controlled driver.

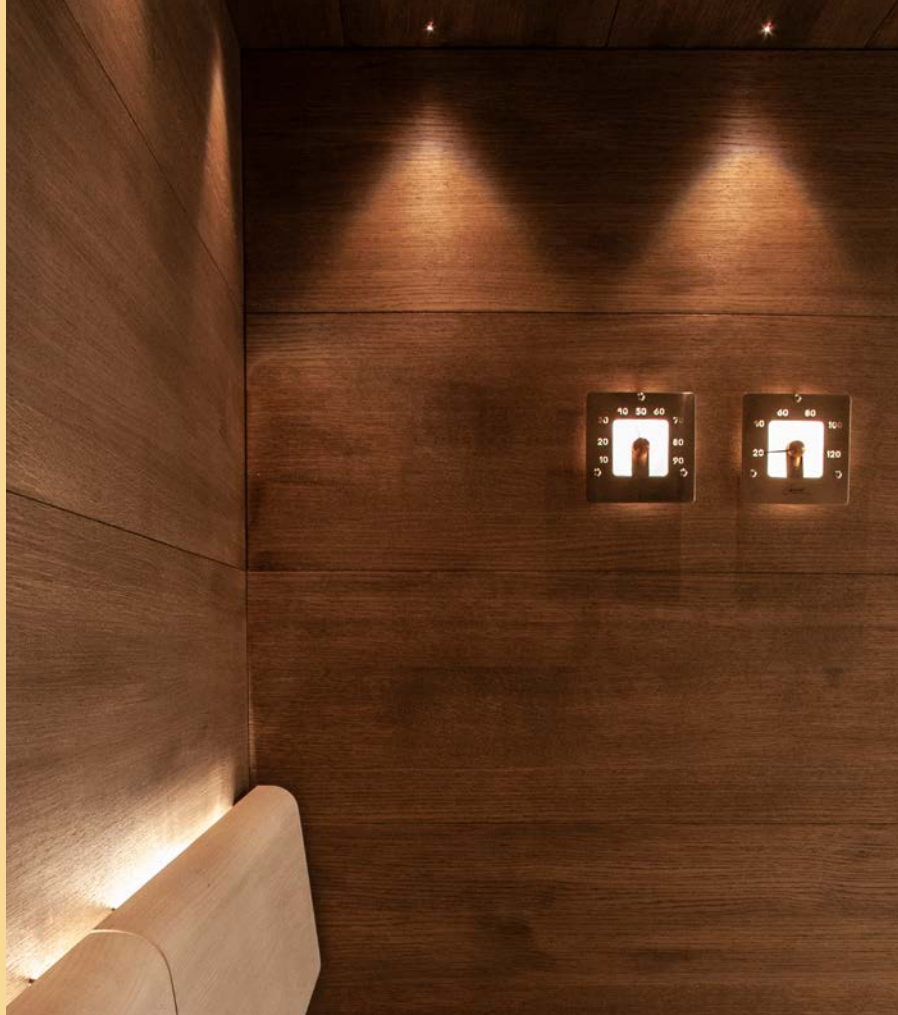

GLASS FIBER HARNESSES

Fiber harnesses made of glass fiber are a long-lasting and durable choice for sauna lighting.

Our selection includes fiber harnesses for saunas of many sizes.

S832 GLASS FIBER HARNESS

8-fiber glass fiber harness for sauna lighting



S832 GLASS FIBER HARNESS

Code: 1506006

- Fiber lengths:
Ø 2 mm (M5) 2 x 2,5 m / 3 x 3,0 m / 2 x 3,5 m
Ø 3 mm (M5) 1 x 3,5 m (stove light fiber)

N211 GLASS FIBER HARNESS

11-fiber glass fiber harness for sauna lighting



N211 GLASS FIBER HARNESS

Code: 1507001

- Fiber lengths:
Ø 2 mm (M5) 5 x 3,5 m / 5 x 4,0 m
Ø 4 mm (M5) 1 x 3,5 m (stove light fiber)

N221 GLASS FIBER HARNESS

21-fiber glass fiber harness for sauna lighting



N221 GLASS FIBER HARNESS

Code: 1507002

- Fiber lengths:
Ø 2 mm (M5) 5 x 3,5 m / 5 x 4,0 m / 5 x 4,5 m / 5 x 5,0 m
Ø 4 mm (M5) 1 x 3,5 m (stove light fiber)

L114 GLASS FIBER HARNESS

11-fiber glass fiber harness for sauna lighting



L114 GLASS FIBER HARNESS

Code: 1505007

- Fiber lengths:
Ø 3 mm (M5) 2 x 2,0 m / 3 x 3,0 m / 3 x 4,0 m / 2 x 5,0 m
Ø 6 mm (M8) 1 x 4,0 m (stove light fiber)

F325 GLASS FIBER HARNESS

7-fiber glass fiber harness for sauna lighting



F325 GLASS FIBER HARNESS

Code: 1505001

- Fiber lengths:
Ø 3 mm (M5) 2 x 2,0 m / 3 x 2,5 m / 2 x 3,0 m

F335 GLASS FIBER HARNESS

7-fiber glass fiber harness for sauna lighting



F335 GLASS FIBER HARNESS

Code: 1505002

- Fiber lengths:
Ø 3 mm (M5) 2 x 3,0 m / 2 x 3,5 m / 2 x 4,0 m

PRODUCT INFORMATION

The operating temperature of glass fibers is -50 °C to +180 °C. The fiber is very flexible and easy to handle. Its light conductivity is very good and it does not get old. Fiberglass lighting is the only one that can be installed on top of the heater on the ceiling.

In addition to the fiber harness, you will need a projector. Please note that projectors VPL10 and VPL25 are not suitable for illuminating these harnesses. The fiber you can install a lens, crystal and, for example, a water bowl or other light fitting.

CE 75 STARRY SKY HARNESS

75-fiber glass fiber harness for sauna lighting



CE 75 STARRY SKY GLASS FIBER HARNESS

Code: 1506012

Fiber lengths:

- Ø 1 mm (B1) 25 x 2,0 m / 25 x 2,5 m / 25 x 3,0 m

CE 100 STARRY SKY HARNESS

100-fiber glass fiber harness for sauna lighting



CE 100 STARRY SKY GLASS FIBER HARNESS

Code: 1506013

Fiber lengths:

- Ø 1 mm (B1) 25 x 2,0 m / 50 x 2,5 m / 25 x 3,0 m

G211 GLASS FIBER HARNESS

11-fiber glass fiber harness for sauna lighting



G211 GLASS FIBER HARNESS

Code: 1507603

Fiber lengths:

- Ø 2 mm (B2) 4 x 1,4 m / 4 x 1,7 m / 2 x 2,0 m
- Ø 4 mm (M8) 1 x 4,0 m (stove light fiber)

G217 GLASS FIBER HARNESS

17-fiber glass fiber harness for sauna lighting



G217 GLASS FIBER HARNESS

Code: 1507604

Fiber lengths:

- Ø 2 mm (B2) 4 x 1,4 m / 4 x 1,7 m / 4 x 2,0 m / 2 x 2,3 m / 2 x 2,6 m
- Ø 4 mm (M8) 1 x 4,0 m (stove light fiber)

G223 GLASS FIBER HARNESS

23-fiber glass fiber harness for sauna lighting



G223 GLASS FIBER HARNESS

Code: 1507605

Fiber lengths:

- Ø 2 mm (B2) 4 x 1,4 m / 4 x 1,7 m / 4 x 2,0 m / 4 x 2,3 m / 2 x 2,6 m / 2 x 2,9 m / 2 x 3,2 m
- Ø 4 mm (M8) 1 x 4,0 m (and stove light fiber)

G229 GLASS FIBER HARNESS

29-fiber glass fiber harness for sauna lighting



G229 GLASS FIBER HARNESS

Code: 1507606

Fiber lengths:

- Ø 2 mm (B2) 4 x 1,4 m / 4 x 1,7 m / 4 x 2,0 m / 4 x 2,3 m / 4 x 2,6 m / 2 x 2,9 m / 2 x 3,2 m / 2 x 3,5 m / 2 x 3,8 m
- Ø 4 mm (M8) 1 x 4,0 m (stove light fiber)

CE 100 LONG STARRY SKY HARNESS

100-fiber glass fiber harness for sauna lighting



CE 100 LONG STARRY SKY GLASS FIBER HARNESS

Code: 1806007

Fiber lengths:

- Ø 1 mm (B1) 25 x 4,0 m / 50 x 5,0 m / 25 x 6,0 m



FANTASIA HARNESS F602

Code: 1506015

- S-Flex 6, M8
- Lengths: 2 x 3,0 m

The harness is also suitable for lighting one Sauna Linear Glass bar.

PRODUCT INFORMATION

The operating temperature of glass fibers is $-50\text{ }^{\circ}\text{C}$ to $+180\text{ }^{\circ}\text{C}$. The fiber is very flexible and easy to handle. Its light conductivity is very good and it does not get old. Fiberglass lighting is the only one that can be installed on top of the heater on the ceiling.

In addition to the fiber harness, you will need a projector. Please note that projectors VPL10 and VPL25 are not suitable for illuminating these harnesses. The fiber you can install a lens, crystal and, for example, a water bowl or other light fitting.

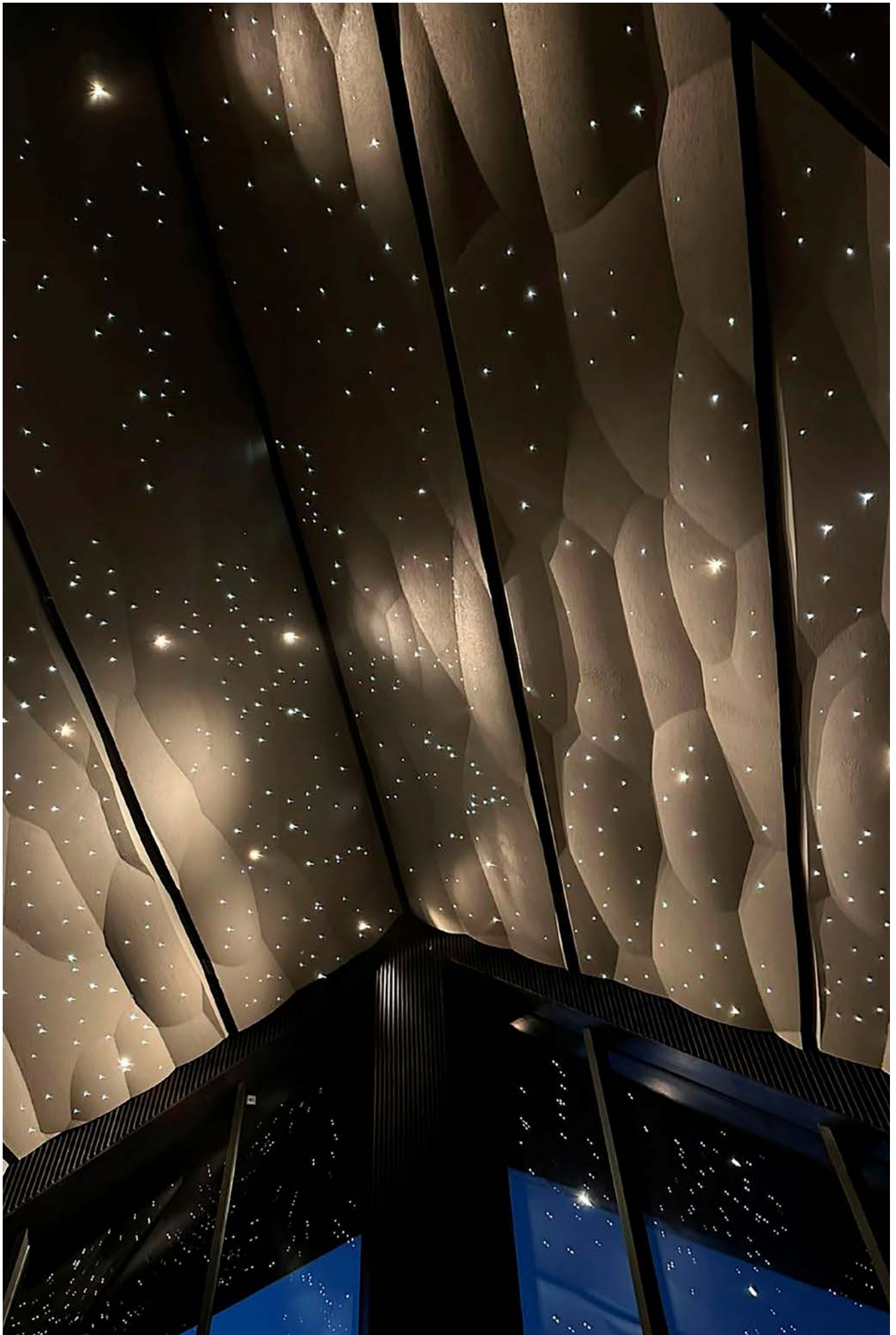

OPTIC FIBERS

With optic fibres light can be taken everywhere. There is no electricity or heat in the fibres, there is only light. When producing a fibre harness the projector end is hermetically sealed to keep the fibre clean and later prevent it from melting. The projector end is protected with a thermal protection filter. All fibre joints and endings in the fibre harness are made without adhesives using the so-called dry polishing method which gives the best light conductivity performance on the market.

PLASTIC SINGLE CORE FIBERS



Bare plastic single core fiber

Type	Code	Active Ø	Outer Ø mm	Bend radius mm	Ferrule	Max tails/projector
CK 0.75	1530016	0.75	0.75	5	-	650

Plastic single core fiber with black outer tubing

Type	Code	Active Ø	Outer Ø mm	Bend radius mm	Ferrule	Max tails/projector
CK-FLEX 2	1530010	2	2.5	15	M5	90

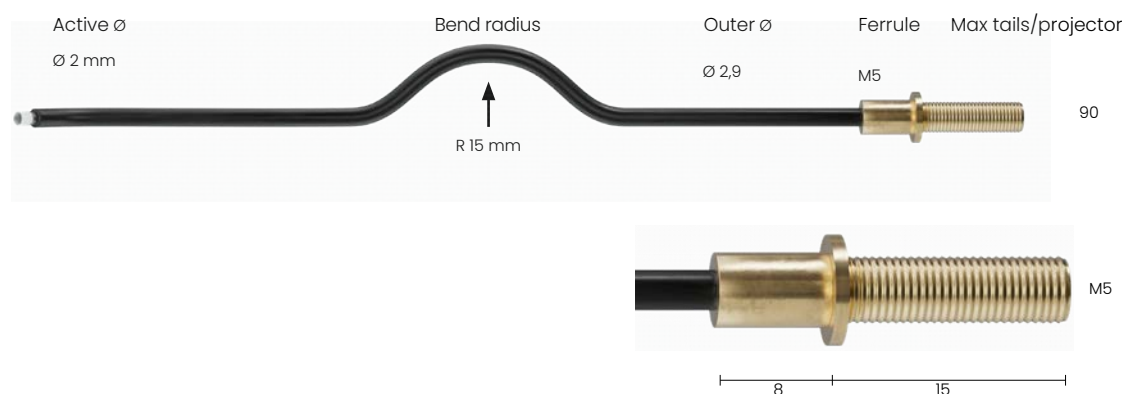

PLASTIC STRANDED FIBERS



- C-Flex plastic fibres are made of 0.75 mm strands, e.g. a 4 mm fibre consists of 25 single 0.75 mm strands.
- The light transmitting of plastic fibres is excellent, the light reduction is approx. 3% / m.
- The recommended ambient temperature is -40 °C - +80 °C.
- The recommended fibre length is max 10 m.

Model	0,75 strands/ fiber	Active Ø	Bend radius	Outer Ø	Ferrule	Max tails/projector
C-FLEX 2 Code: 1530005	7	2,1 mm	R 7,5 mm	5	M5/M8	92
C-Flex 3 Code: 1530006	13	3,0 mm	R 10 mm	5,6	M5/M8	50
C-Flex 4 Code: 1530007	25	4,3 mm	R 15 mm	7	M8	26
C-Flex 6 Code: 1530008	50	6 mm	R 20 mm	10	M8	13
C-Flex 7 Code: 1530009	75	7,5 mm	R 28 mm	11,5	M10	8

END-EMITTING GLASS FIBERS

- Glass fibers are produced of 0.05 mm glass strands. The fiber is flexible and easy to handle.
- The recommended ambient temperature of Cariitti glass fiber sets is -50 °C - +180 °C.
- Glass fibers do not wear out and they can be used both indoors and outdoors.
- The light transmitting is excellent, the light reduction is approx. 5% / m.
- The recommended fiber length is max 10 m.

Model	Active \varnothing	Outer \varnothing	Bend radius	Ferrule	Max tails/ projector
S-FLEX 1 Code: 1530300	\varnothing 1,0 mm	Outer \varnothing 2,2 mm	R 10 mm	B1	290
S-FLEX 1,5 Code: 1530301	\varnothing 1,4 mm	Outer \varnothing 2,7 mm	R 10 mm	B1.5 / M5	182
S-FLEX 2 Code: 1530302	\varnothing 2,0 mm	Outer \varnothing 3,85 mm	R 15 mm	B2 / M5	90
S-FLEX 3 Code: 1530303	\varnothing 3,0 mm	Outer \varnothing 4,85 mm	R 20 mm	B3 / M5	52
S-FLEX 4 Code: 1530304	\varnothing 4,0 mm	Outer \varnothing 6,35 mm	R 25 mm	B4 / M8	32
S-Flex 6 Code: 1530306	\varnothing 5,8 mm	Outer \varnothing 8,7 mm	R 50 mm	M8	17
S-Flex 7 Code: 1530307	\varnothing 7,3 mm	Outer \varnothing 10,1 mm	R 60 mm	M10	10

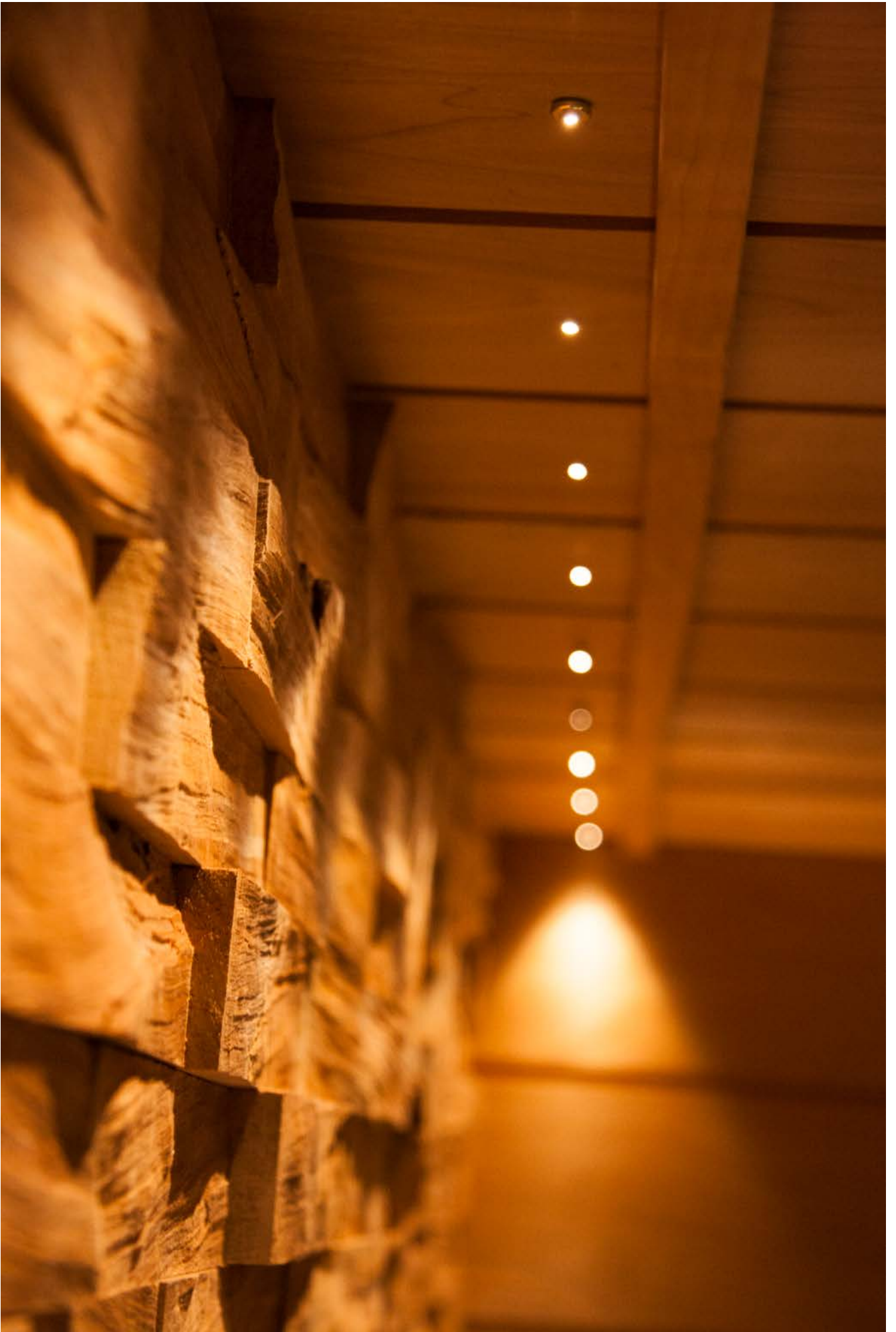

POWER SUPPLIES, CONTROL UNITS AND REGULATORS

Power supplies and control units are available with push-button, DALI and DMX control options.

CONSTANT CURRENT LED DRIVERS



OTi DALI 10 (150 mA)

Code: 1532443

OTi DALI 10 (350 mA)

Code: 1532449

- Nominal input voltage 220–240 V
- Network frequency 50–60 Hz
- Output power, partial load 1–13 W 150 mA / 1–9 W 350 mA
- Ambient temperature range T_a -20...+50°C
- Wire size 0.2–1.5 mm²
- Dimensions L 124 mm x W 31 mm x H 21 mm
- Dimming: DALI or push-button
- Weight 80 g
- IP20



OTi DALI 15 (150 mA)

Code: 1532296

OTi DALI 15 (350 mA)

Code: 1532442

- Nominal input voltage 220–240 V
- Network frequency 50–60 Hz
- Output power, partial load 3–15 W 150mA / 350 mA
- Ambient temperature range T_a -20...+50°C
- Wire size 0.2–1.5 mm²
- Dimensions L 95 mm x W 53 mm x H 30 mm
- Dimming: DALI or push-button
- Weight 116 g
- IP20



POWER SUPPLY FOR 3–6 LEDs

Code: 1863005

- Constant current LED driver 350 mA
- Nominal input voltage 220–240 V
- Network frequency 50–60 Hz
- Output power, partial load 3–6 W
- Ambient temperature range T_a -20...+50°C
- Wire size 0.2–1.5 mm²
- Dimensions L 152 mm x W 87 mm x H 52 mm
- Dimming with trailing edge (TE) dimmer
- Weight 190 g
- IP55



POWER SUPPLY FOR 1–3 LEDs

Code: 1545240

- Constant current LED driver 350 mA
- Nominal input voltage 100–240 V
- Network frequency 50–60 Hz
- Output power, partial load 1–3 W
- Ambient temperature range T_a -20...+60°C
- Wire size 0.2–1.5 mm²
- Dimensions L 130 mm x W 86 mm x H 39 mm
- Non-dimmable
- Weight 130 g
- IP55



DRIVER FOR RGBW LEDs

Code: 1863032

- Constant current 200 mA
- Nominal input voltage 100 – 240 V
- Network frequency 50...60 Hz
- Output power to channel max. 4,8 W
- Output power max. 19,2 W
- On the secondary side, only serial connection
- Ambient temperature range T_a -10...+60°C
- Wire size 0.2 – 1.5 mm²
- Power supply size: L 96 mm x W 45 mm x H 30 mm
- Control unit size: L 186 mm x W 29 mm x H 21 mm
- Mounting box size: L 100 mm x W 100 mm x H 47 mm

CONSTANT CURRENT DRIVERS

When you are looking for compact or linear control unit solutions, we offer a complete range of power supplies. Ultra-consistent lighting quality and reliability are achieved with the products in this range.



ICUTRONIC 7W

Code: 1863030

- Nominal input voltage 220...240 V
- Mains frequency 50/60 Hz
- Nominal output voltage 2.5...11 V
- U-OUT 60 V
- Nominal output current 350...700mA
- Nominal output power 0.88...7.7 W
- Galvanic isolation SELV
- Dimensions: L 104 x W 30 x H 26 mm
- Non-dimmable
- Cable cross-section 0.5...1.5 mm² / 0.75...1.5 mm²
- Wire preparation length 7...8 mm
- Weight 54 g



OTi DALI 10

Code: 1863039

- Nominal input voltage 220...240 V
- Mains frequency 0/50/60 Hz
- Nominal output voltage 2.5...45 V
- U-OUT 60 V
- Nominal output current 150...700 mA
- Nominal output power 10 W
- Galvanic isolation SELV
- Dimensions: L 124 x W 31 x H 21 mm
- Dimming DALI or touch dim
- Cable cross-section 0.5...1.5 mm²
- Wire preparation length 7...8 mm
- Weight 80 g



Oti DALI 15

Code: 1863040

- Nominal input voltage 220...240 V
- Mains frequency 0/50/60 Hz
- Nominal output voltage 7.5...54 V
- U-OUT 60 V
- Nominal output current 150...1050 mA
- Nominal output power 18 W
- Galvanic isolation SELV
- Dimensions: L 95 x W 53 x H 30 mm
- Dimming DALI or touch dim
- Cable cross-section 0.2...1.5 mm²
- Wire preparation length 8...9 mm
- Weight 116 g



OT FIT 18

Code: 1863035

- Nominal input voltage 220...240 V
- Mains frequency 50/60 Hz
- Nominal output voltage 27...40 V
- U-OUT 60 V
- Nominal output current 225...450 mA
- Nominal output power 18 W
- Galvanic isolation SELV
- Dimensions: L 95 x W 50 x H 22 mm
- Mains dimmable
- Cable cross-section 0.75...1.5 mm²
- Wire preparation length 5...6 mm
- Weight 77 g



DALI MCU TW G2 ROTARY DIMMER

Code: 1545715

- The dimmer is compatible with both a traditional DALI driver and a DT8 driver. The dimmer has a built-in 52mA DALI power supply.
- Max. 25 DALI devices / active dimmer
- Max. 4 control points (100 LED drivers and automatic synchronization of control points)
- DALI broadcast
- DALI cabling length max. 300 m
- Comes with a white cover plate and rotary knob
- Also suitable for e.g. Schneider Exxact and Jung covers

CONSTANT VOLTAGE



OT FIT 36

Code: 1863036

- Nominal input voltage 220...240 V
- Mains frequency 50/60 Hz
- Nominal output voltage 24.2 V
- Maximum output power 36.3 W
- Galvanic isolation SELV
- Dimensions: L 103 x H 29.5 x W 67 mm
- Mains dimmable
- Cable cross-section, input side 0.5...1.5 mm²
- Cable cross-section, output side 0.75...1.5 mm²
- Wire preparation length 7...8 mm
- Weight 162 g



OT FIT 75

Code: 1863037

- Nominal input voltage 220...240 V
- Mains frequency 50/60 Hz
- Nominal output voltage 24.2 V
- Maximum output power 75.8 W
- Galvanic isolation SELV
- Dimensions: L 110 x H 30 x W 73 mm
- Mains dimmable
- Cable cross-section, input side 0.5...1.5 mm²
- Cable cross-section, output side 0.75...1.5 mm²
- Wire preparation length 7...8 mm
- Weight 210 g



OTi DALI DIM 1-4ch+D CONTROLLER

Code: 1832177

- Nominal input voltage 12...48 V
- Mains frequency 0 Hz
- Nominal output voltage 12...48 V
- Maximum output power 240 W
- Galvanic isolation SELV
- Dimensions: L 181 x W 42 x H 20 mm
- Cable cross-section 0.5...2.5 mm²
- Wire preparation length 5...8 mm
- Weight 86 g



OT WI 50

Code: 1832176

- Nominal input voltage 220...240 V
- Mains frequency 50/60 Hz
- Nominal output voltage 24.2 V
- Maximum output power 50 W
- Galvanic isolation SELV
- Wireless Casambi protocol
- Dimensions: L 346 x W 32 x H 22 mm
- Cable cross-section, input side 0.75...2.5 mm²
- Cable cross-section, output side 0.2...1.5 mm²
- Wire preparation length 6.0 mm
- Weight 191 g



OT WI 80

Code: 1532137

- Nominal input voltage 220...240 V
- Mains frequency 50/60 Hz
- Nominal output voltage 24.2 V
- Maximum output power 80 W
- Galvanic isolation SELV
- Wireless Casambi protocol
- Dimensions: L 346 x W 32 x H 22 mm
- Cable cross-section, input side 0.75...2.5 mm²
- Cable cross-section, output side 0.2...1.5 mm²
- Wire preparation length 6.0 mm
- Weight 191 g

CASAMBI

Casambi is a lighting control system based on Bluetooth Low Energy technology (BLE). The system includes luminaires, voltage sources, control modules, dimmers, sensors, switches, adapters, etc.



WIRELESS BLE LIGHT CONTROL UNIT

Code: 1832112

Wireless control unit CBU-ASD for LED and halogendrivers with 0–10 V, 1–10 V or DALI dimming interface

- Input voltage 220–240 VAC, 50 Hz, 0.6 A
 - Mains output: 220–240 VAC, 50 Hz, solid-state relay (SSR) on phase line
 - 0–10 V output: 0–10 VDC, 7 mA
 - Dimensions: L 56,5 x W 35,8 x H 22,3 mm
 - Weight 48 g
 - IP20
-



BLE DIMMER 230 VAC 50–150W

Code: 1832119

BLE controllable trailing-edge dimmer CBU-TED-E for operation of incandescent lamps, dimmable LED lamps and dimmable LED controllers

- Input voltage 85–240 VAC, 50–60 Hz, 0.65 A
 - Output depending on load type:
50–150 W @ 230 VAC / 25–70 W @ 110 VAC
 - Maximum input voltage 0,65 A
 - Minimum load requirement 1W
 - Maximum inrush current 4 A
 - Dimensions: L 40,4 x W 36,3 x H 14 mm
 - Weight 16 g
 - IP20
 - Dimming: Trailing Edge (TE)
-



BLE PWM DIMMER

Code: 1832123

A four channel PWM dimmer CBU-PWM4 for constant voltage LED loads, such as LED strips and constant voltage LED modules. It is connected between a 12–24 VDC power supply and the constant voltage LED load. The dimmer has four controllable channels making it an ideal product for RGBW and tunable white (TW) applications.

- Input voltage: 12–24 VDC
- Output voltage: same as input voltage 12–24 VDC
- Maximum input current 6 A
- Maximum output current 6 A (can be freely divided between the channels)
- Maximum output power 72 W @ 12 VDC / 144 W @ 24 VDC
- Minimum load requirement 0 W
- No-load standby power < 0,3 W
- Dimensions: L 72.6 x W 30 x H 18 mm
- Weight 22 g
- IP20
- Dimming method: Pulse Width Modulation (PWM)



**SINGLE WALL SWITCH BLE,
2 CHANNELS (anthracite)**

Code: 1832002

- Wireless
- No battery needed
- Dimensions: L 70 x W 70 x H 16 mm
- Weight 119 g
- IP21



**SINGLE WALL SWITCH BLE,
2 CHANNELS (white)**

Code: 1832003

- Wireless
- No battery needed
- Dimensions : L 70 x W 70 x H 16 mm
- Weight 119 g
- IP21

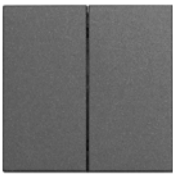

**DOUBLE WALL SWITCH BLE,
4 CHANNELS (anthracite)**

Code: 1832000

- Wireless
- No battery needed
- Dimensions: L 70 x W 70 x H 16 mm
- Weight 119 g
- IP21



**DOUBLE WALL SWITCH BLE,
4 CHANNELS (white)**

Code: 1832001

- Wireless
- No battery needed
- Dimensions: L 70 x W 70 x H 16 mm
- Weight 119 g
- IP21

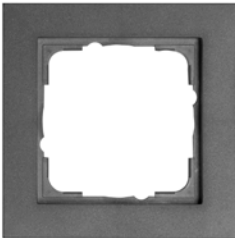

**FRAME FOR WALL SWITCH BLE
(anthracite)**

Code: 1532135

- Dimensions: L 80 x W 80 x H 9 mm
- Weight 15 g
- IP21



**FRAME FOR WALL SWITCH BLE
(white)**

Code: 1532195

- Dimensions: L 80 x W 80 x H 9 mm
- Weight 15 g
- IP21



**XPRESS SWITCH BLE
(black)**

Code: 1532800

- Wireless
- Battery CR 2430 Lithium-ion
- Battery life 2–5 years
- A mounting bracket for wall mounting included
- Range max 50 m in open space
- Dimensions: L 90 x W 90 x H 12 mm
- Weight 125 g
- IP21



**XPRESS SWITCH BLE
(white)**

Code: 1532801

- Wireless
- Battery CR 2430 Lithium-ion
- Battery life 2–5 years
- A mounting bracket for wall mounting included
- Range max 50 m in open space
- Dimensions: L 90 x W 90 x H 12 mm
- Weight 125 g
- IP21



DOWNLOAD THE CASAMBI APPLICATION



Cariitti

Cariitti Oy
Niittyrinne 2B, FI-02270 Espoo, Finland
Tel. +358 9 221 9040, sales@cariitti.com
www.cariitti.com