

Fișă tehnică | Număr articol: 2002-3248

Triple-deck terminal block; Shield/through/through terminal block; Shield/N/L; with marker carrier; for DIN-rail 35 x 15 and 35 x 7.5; 2.5 mm²; Push-in CAGE CLAMP®; 2,50 mm²; gray

www.wago.com/2002-3248

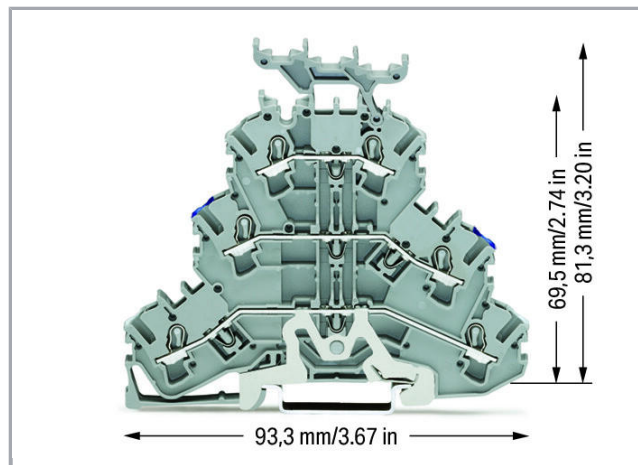
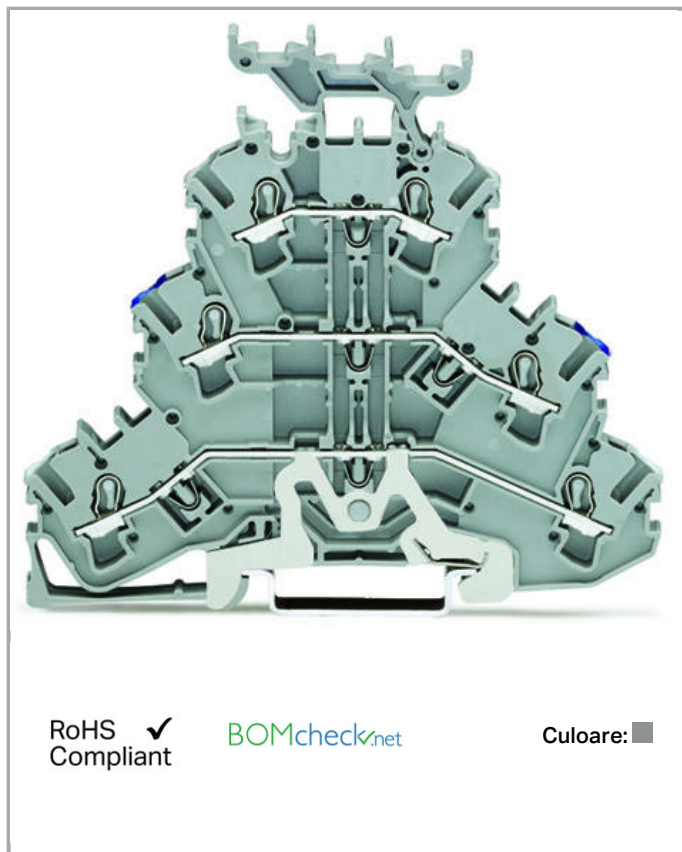

Supus modificărilor.

WAGO Kontakttechnik GmbH & Co. KG
/Representative Office Romania
Sos. Pipera-Tunari nr. 1/1
building 1, 2nd floor | 077190 Voluntari, Ilfov
Tel.: +40-(0)31 421 85 68 | Email: info-RO@wago.com

Aveți întrebări despre produsele noastre?
Vă stăm la dispoziție pentru preluarea apelului la +40 (0) 31 421 85 68.

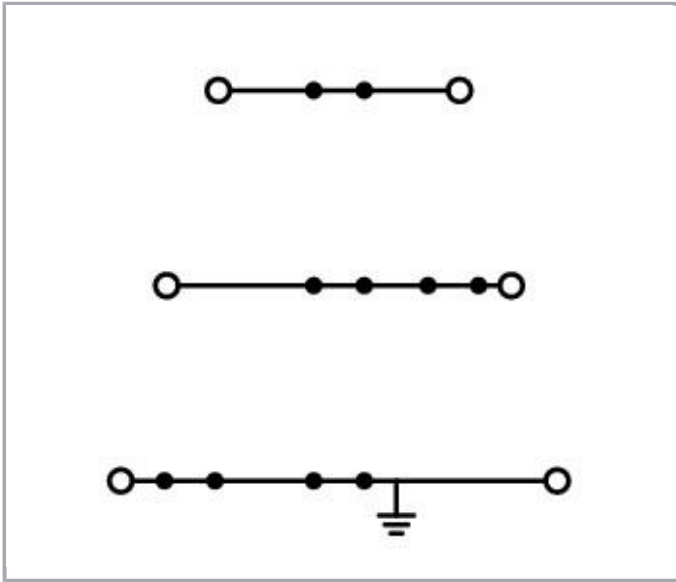
**Date****Electrical data****Ratings per IEC/EN 60664-1**

Ratings per	IEC/EN 60947-7-1
Nominal voltage (III/3)	500 V
Rated surge voltage (III/3)	6 kV
Rated current	24 A
Rated current 2	28 A
Legend (ratings)	(III / 3) ≙ Overvoltage category III / Pollution degree 3

Approvals per UL 1059

Rated voltage UL (Use Group B)	300 V
Rated current UL (Use Group B)	20 A
Rated voltage UL (Use Group C)	300 V
Rated current UL (Use Group C)	20 A
Rated voltage UL (Use Group D)	600 V
Rated current UL (Use Group D)	5 A
Approvals per	UL 1059

Approvals per CSA

Rated voltage CSA (Use Group B)	600 V
---------------------------------	-------

Supus modificărilor.

WAGO Kontakttechnik GmbH & Co. KG
 /Representative Office Romania
 Sos. Pipera-Tunari nr. 1/1
 building 1, 2nd floor | 077190 Voluntari, Ilfov
 Tel.: +40-(0)31 421 85 68 | Email: info-RO@wago.com

Aveți întrebări despre produsele noastre?
 Vă stăm la dispoziție pentru preluarea apelului la +40 (0) 31 421 85 68.



Rated current CSA (Use Group B)	20 A
Rated voltage CSA (Use Group C)	600 V
Rated current CSA (Use Group C)	20 A

Connection data

Connection technology	Push-in CAGE CLAMP®
Number of connection points (connection type)	3
Actuation type	Push-in Open Tool Slot
Connectable conductor materials	Copper
Nominal cross-section	2,5 mm ²
Solid conductor	0,25 ... 4 mm ² / 22 ... 12 AWG
Solid conductor; push-in termination	0,75 ... 4 mm ² / 18 ... 12 AWG
Fine-stranded conductor	0,25 ... 4 mm ² / 22 ... 12 AWG
Fine-stranded conductor; with insulated ferrule	1 ... 2,5 mm ² / 18 ... 12 AWG
Fine-stranded conductor; with ferrule; push-in termination	1 ... 2,5 mm ² / 18 ... 12 AWG
Strip length	10 ... 12 mm / 0.39 ... 0.47 inch
Number of connection points	3
Total number of connection points	6
Total number of potentials	3
Number of levels	3
Wiring type	Front-entry wiring
Note (conductor cross-section)	Depending on the conductor characteristic, a conductor with a smaller cross section can also be inserted via push-in termination.

Geometrical Data

Width	5,2 mm / 0.205 inch
Height from upper-edge of DIN-rail	81,3 mm / 3.201 inch
Depth	93,3 mm / 3.673 inch

Mechanical data

Design	horizontal
Mounting type	DIN-35 rail
Potential marking	Schirm/N/L
Marking level	Center/side marking

Supus modificărilor.

WAGO Kontakttechnik GmbH & Co. KG
/Representative Office Romania
Sos. Pipera-Tunari nr. 1/1
building 1, 2nd floor | 077190 Voluntari, Ilfov
Tel.: +40-(0)31 421 85 68 | Email: info-RO@wago.com

Aveți întrebări despre produsele noastre?
Vă stăm la dispoziție pentru preluarea apelului la +40 (0) 31 421 85 68.

Material Data



Color	gray
Insulation material	Polyamide 66 (PA 66)
Fire load	0,326 MJ
Weight	20,4 g

Commercial data

Product Group	22 (TOPJOB S)
Packaging type	BOX
Country of origin	DE
GTIN	4044918989657
Customs tariff number	85369010000

Aprobări / certificate

Country specific Approvals

Embleă	Aprobare	Text de aprobare suplimentar	Nume certificat
	CCA DEKRA Certification B.V.	EN 60947	NTR NL 7730
	CSA DEKRA Certification B.V.	C22.2 No. 158	1536069
	KEMA/KEUR DEKRA Certification B.V.	EN 60947	71- 107687

Ship Approvals

Embleă	Aprobare	Text de aprobare suplimentar	Nume certificat
	ABS American Bureau of Shipping	EN 60947	20- HG1941090- PDA
	BV Bureau Veritas S.A.	EN 60947	38586/A0 BV

Supus modificărilor.

BUREAU
VERITAS

DNV GL

Det Norske Veritas, Germanischer Lloyd

TAE00001V2







UL-Approvals

Emblemă	Aprobare	Text de aprobare suplimentar	Nume certificat
	cURus Underwriters Laboratories Inc.	UL 1059	E45172

Counterpart

Produse compatibile















ferrule

	Nr. articol: 216-241 Ferrule; Sleeve for 0.5 mm ² / 20 AWG; insulated; electro-tin plated; electrolytic copper; gastight crimped; acc. to DIN 46228, Part 4/09.90; white	www.wago.com/216-241
	Nr. articol: 216-242 Ferrule; Sleeve for 0.75 mm ² / 18 AWG; insulated; electro-tin plated; electrolytic copper; gastight crimped; acc. to DIN 46228, Part 4/09.90; gray	www.wago.com/216-242
	Nr. articol: 216-243 Ferrule; Sleeve for 1 mm ² / AWG 18; insulated; electro-tin plated; electrolytic copper; gastight crimped; acc. to DIN 46228, Part 4/09.90; red	www.wago.com/216-243
	Nr. articol: 216-244 Ferrule; Sleeve for 1.5 mm ² / AWG 16; insulated; electro-tin plated; electrolytic copper; gastight crimped; acc. to DIN 46228, Part 4/09.90; black	www.wago.com/216-244
	Nr. articol: 216-246	

Supus modificărilor.

WAGO Kontakttechnik GmbH & Co. KG
/Representative Office Romania
Sos. Pipera-Tunari nr. 1/1
building 1, 2nd floor | 077190 Voluntari, Ilfov
Tel.: +40-(0)31 421 85 68 | Email: info-RO@wago.com















Aveți întrebări despre produsele noastre?
Vă stăm la dispoziție pentru preluarea apelului la +40 (0) 31 421 85 68.

	Ferrule; Sleeve for 2.5 mm ² / AWG 14; insulated; electro-tin plated; electrolytic copper; gastight crimped; acc. to DIN 46228, Part 4/09.90; blue	www.wago.com/216-246
	Nr. articol: 216-262 Ferrule; Sleeve for 0.75 mm ² / 18 AWG; insulated; electro-tin plated; electrolytic copper; gastight crimped; acc. to DIN 46228, Part 4/09.90; gray	www.wago.com/216-262
	Nr. articol: 216-263 Ferrule; Sleeve for 1 mm ² / AWG 18; insulated; electro-tin plated; electrolytic copper; gastight crimped; acc. to DIN 46228, Part 4/09.90; red	www.wago.com/216-263
	Nr. articol: 216-264 Ferrule; Sleeve for 1.5 mm ² / AWG 16; insulated; electro-tin plated; electrolytic copper; gastight crimped; acc. to DIN 46228, Part 4/09.90; black	www.wago.com/216-264
	Nr. articol: 216-266 Ferrule; Sleeve for 2.5 mm ² / AWG 14; insulated; electro-tin plated; electrolytic copper; gastight crimped; acc. to DIN 46228, Part 4/09.90; blue	www.wago.com/216-266
Marking accessories		
	Nr. articol: 2002-161 Adaptor	www.wago.com/2002-161
	Nr. articol: 2009-110 Marking strips; on reel; not stretchable; plain; snap-on type; white	www.wago.com/2009-110
	Nr. articol: 2009-115 WMB-Inline; for Smart Printer; 1500 pieces on roll; stretchable 5 - 5.2 mm; plain; snap-on type; white	www.wago.com/2009-115
	Nr. articol: 2009-115/000-002 WMB-Inline; for Smart Printer; 1500 pieces on roll; stretchable 5 - 5.2 mm; plain; snap-on type; yellow	www.wago.com/2009-115/000-002
	Nr. articol: 2009-115/000-005 WMB-Inline; for Smart Printer; 1500 pieces on roll; stretchable 5 - 5.2 mm; plain; snap-on type; red	www.wago.com/2009-115/000-005
	Nr. articol: 2009-115/000-006 WMB-Inline; for Smart Printer; 1500 pieces on roll; stretchable 5 - 5.2 mm; plain; snap-on type; blue	www.wago.com/2009-115/000-006
	Nr. articol: 2009-115/000-007 WMB-Inline; for Smart Printer; 1500 pieces on roll; stretchable 5 - 5.2 mm; plain; snap-on type; gray	www.wago.com/2009-115/000-007
	Nr. articol: 2009-115/000-012 WMB-Inline; for Smart Printer; 1500 pieces on roll; stretchable 5 - 5.2 mm; plain; snap-on type; orange	www.wago.com/2009-115/000-012
	Nr. articol: 2009-115/000-017 WMB-Inline; for Smart Printer; 1500 pieces on roll; stretchable 5 - 5.2 mm; plain; snap-on type; light green	www.wago.com/2009-115/000-017
	Nr. articol: 2009-115/000-023 WMB-Inline; for Smart Printer; 1500 pieces on roll; stretchable 5 - 5.2 mm; plain; snap-on type; green	www.wago.com/2009-115/000-023













Supus modificărilor.

WAGO Kontakttechnik GmbH & Co. KG
/Representative Office Romania
Sos. Pipera-Tunari nr. 1/1
building 1, 2nd floor | 077190 Voluntari, Ilfov
Tel.: +40-(0)31 421 85 68 | Email: info-RO@wago.com

Aveți întrebări despre produsele noastre?
Vă stăm la dispoziție pentru preluarea apelului la +40 (0) 31 421 85 68.

	Nr. articol: 2009-115/000-024 WMB-Inline; for Smart Printer; 1500 pieces on roll; stretchable 5 - 5.2 mm; plain; snap-on type; violet	www.wago.com/2009-115/000-024
	Nr. articol: 2009-145 Mini-WSB Inline; for Smart Printer; 1700 pieces on roll; stretchable 5 - 5.2 mm; plain; snap-on type; white	www.wago.com/2009-145
	Nr. articol: 2009-145/000-002 Mini-WSB Inline; for Smart Printer; 1700 pieces on roll; stretchable 5 - 5.2 mm; plain; snap-on type; yellow	www.wago.com/2009-145/000-002
	Nr. articol: 2009-145/000-005 Mini-WSB Inline; for Smart Printer; 1700 pieces on roll; stretchable 5 - 5.2 mm; plain; snap-on type; red	www.wago.com/2009-145/000-005
	Nr. articol: 2009-145/000-006 Mini-WSB Inline; for Smart Printer; 1700 pieces on roll; stretchable 5 - 5.2 mm; plain; snap-on type; blue	www.wago.com/2009-145/000-006
	Nr. articol: 2009-145/000-007 Mini-WSB Inline; for Smart Printer; 1700 pieces on roll; stretchable 5 - 5.2 mm; plain; snap-on type; gray	www.wago.com/2009-145/000-007
	Nr. articol: 2009-145/000-012 Mini-WSB Inline; for Smart Printer; 1700 pieces on roll; stretchable 5 - 5.2 mm; plain; snap-on type; orange	www.wago.com/2009-145/000-012
	Nr. articol: 2009-145/000-023 Mini-WSB Inline; for Smart Printer; 1700 pieces on roll; stretchable 5 - 5.2 mm; plain; snap-on type; green	www.wago.com/2009-145/000-023
	Nr. articol: 2009-145/000-024 Mini-WSB Inline; for Smart Printer; 1700 pieces on roll; stretchable 5 - 5.2 mm; plain; snap-on type; violet	www.wago.com/2009-145/000-024
	Nr. articol: 2009-191 Group marker carrier	www.wago.com/2009-191
	Nr. articol: 2009-192 Group marker carrier	www.wago.com/2009-192
	Nr. articol: 2009-193 Group marker carrier	www.wago.com/2009-193
	Nr. articol: 2009-198 Adaptor	www.wago.com/2009-198
	Nr. articol: 248-501 Miniature WSB Quick marking system; plain; Marker width 5 mm; 10 strips with 10 markers per card	www.wago.com/248-501
	Nr. articol: 248-501/000-002 Mini-WSB marking card; as card; not stretchable; plain; snap-on type; yellow	www.wago.com/248-501/000-002

Supus modificărilor.

	Nr. articol: 248-501/000-005 Mini-WSB marking card; as card; not stretchable; plain; snap-on type; red	www.wago.com/248-501/000-005
	Nr. articol: 248-501/000-006 Mini-WSB marking card; as card; not stretchable; plain; snap-on type; blue	www.wago.com/248-501/000-006
	Nr. articol: 248-501/000-007 Mini-WSB marking card; as card; not stretchable; plain; snap-on type; gray	www.wago.com/248-501/000-007
	Nr. articol: 248-501/000-012 Mini-WSB marking card; as card; not stretchable; plain; snap-on type; orange	www.wago.com/248-501/000-012
	Nr. articol: 248-501/000-017 Mini-WSB marking card; as card; not stretchable; plain; snap-on type; light green	www.wago.com/248-501/000-017
	Nr. articol: 248-501/000-023 Mini-WSB marking card; as card; not stretchable; plain; snap-on type; green	www.wago.com/248-501/000-023
	Nr. articol: 248-501/000-024 Mini-WSB marking card; as card; not stretchable; plain; snap-on type; violet	www.wago.com/248-501/000-024
	Nr. articol: 793-501 WMB marking card; as card; not stretchable; plain; snap-on type; white	www.wago.com/793-501
	Nr. articol: 793-501/000-002 WMB marking card; as card; not stretchable; plain; snap-on type; yellow	www.wago.com/793-501/000-002
	Nr. articol: 793-501/000-005 WMB marking card; as card; not stretchable; plain; snap-on type; red	www.wago.com/793-501/000-005
	Nr. articol: 793-501/000-006 WMB marking card; as card; not stretchable; plain; snap-on type; blue	www.wago.com/793-501/000-006
	Nr. articol: 793-501/000-007 WMB marking card; as card; not stretchable; plain; snap-on type; gray	www.wago.com/793-501/000-007
	Nr. articol: 793-501/000-012 WMB marking card; as card; not stretchable; plain; snap-on type; orange	www.wago.com/793-501/000-012

Supus modificărilor.



Nr. articol: 793-501/000-017

WMB marking card; as card; not stretchable; plain; snap-on type; light green

www.wago.com/793-501/000-017



Nr. articol: 793-501/000-023

WMB marking card; as card; not stretchable; plain; snap-on type; green

www.wago.com/793-501/000-023



Nr. articol: 793-501/000-024

WMB marking card; as card; not stretchable; plain; snap-on type; violet

www.wago.com/793-501/000-024



Nr. articol: 793-5501

WMB marking card; as card; for terminal block width 5 - 17.5 mm; stretchable 5 - 5.2 mm; plain; snap-on type; white

www.wago.com/793-5501



Nr. articol: 793-5501/000-002

WMB marking card; as card; for terminal block width 5 - 17.5 mm; stretchable 5 - 5.2 mm; plain; snap-on type; yellow

www.wago.com/793-5501/000-002



Nr. articol: 793-5501/000-005

WMB marking card; as card; for terminal block width 5 - 17.5 mm; stretchable 5 - 5.2 mm; plain; snap-on type; red

www.wago.com/793-5501/000-005



Nr. articol: 793-5501/000-006

WMB marking card; as card; for terminal block width 5 - 17.5 mm; stretchable 5 - 5.2 mm; plain; snap-on type; blue

www.wago.com/793-5501/000-006



Nr. articol: 793-5501/000-007

WMB marking card; as card; for terminal block width 5 - 17.5 mm; stretchable 5 - 5.2 mm; plain; snap-on type; gray

www.wago.com/793-5501/000-007



Nr. articol: 793-5501/000-012

WMB marking card; as card; for terminal block width 5 - 17.5 mm; stretchable 5 - 5.2 mm; plain; snap-on type; orange

www.wago.com/793-5501/000-012



Nr. articol: 793-5501/000-014

WMB marking card; as card; for terminal block width 5 - 17.5 mm; stretchable 5 - 5.2 mm; plain; snap-on type; brown

www.wago.com/793-5501/000-014



Nr. articol: 793-5501/000-017

WMB marking card; as card; for terminal block width 5 - 17.5 mm; stretchable 5 - 5.2 mm; plain; snap-on type; green

www.wago.com/793-5501/000-017



Nr. articol: 793-5501/000-023

WMB marking card; as card; for terminal block width 5 - 17.5 mm; stretchable 5 - 5.2 mm; plain; snap-on type; light green

www.wago.com/793-5501/000-023



Nr. articol: 793-5501/000-024

WMB marking card; as card; for terminal block width 5 - 17.5 mm; stretchable 5 - 5.2 mm; plain; snap-on type; violet











www.wago.com/793-5501/000-024

check

Supus modificărilor.

WAGO Kontakttechnik GmbH & Co. KG
/Representative Office Romania
Sos. Pipera-Tunari nr. 1/1
building 1, 2nd floor | 077190 Voluntari, Ilfov
Tel.: +40-(0)31 421 85 68 | Email: info-RO@wago.com

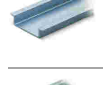













Aveți întrebări despre produsele noastre?
Vă stăm la dispoziție pentru preluarea apelului la +40 (0) 31 421 85 68.

	Nr. articol: 2002-611 TOPJOB®S L-type test plug module; modular; 1-pole; 2,50 mm ² ; gray	www.wago.com/2002-611
	Nr. articol: 2002-649 TOPJOB®S L-type spacer module; modular; e.g., for bridging commoned terminal blocks; gray	www.wago.com/2002-649
	Nr. articol: 2009-174 Test plug adapter; for 4 mm Ø test plugs; for testing TOPJOB®S rail-mounted terminal blocks; gray	www.wago.com/2009-174
	Nr. articol: 2009-182 Testing tap; for max. 2.5 mm ² ; tool-free connection for individual test wires 0.08 - 2.5 mm; gray	www.wago.com/2009-182
Push-In type wire jumper		
	Nr. articol: 2009-412 Push-in type wire jumper; insulated; wire length 60 mm; Conductor cross section 1.5 mm ² ; suitable for 2001, 2002, 2003 and 2022 Series rail-mounted terminal blocks; black	www.wago.com/2009-412
	Nr. articol: 2009-414 Push-in type wire jumper; insulated; wire length 110 mm; Conductor cross section 1.5 mm ² ; suitable for 2001, 2002, 2003 and 2022 Series rail-mounted terminal blocks; black	www.wago.com/2009-414
	Nr. articol: 2009-414/000-005 Push-in type wire jumper; insulated; wire length 110 mm; Conductor cross section 1.5 mm ² ; suitable for 2001, 2002, 2003 and 2022 Series rail-mounted terminal blocks; red	www.wago.com/2009-414/000-005
	Nr. articol: 2009-414/000-006 Push-in type wire jumper; insulated; wire length 110 mm; Conductor cross section 1.5 mm ² ; suitable for 2001, 2002, 2003 and 2022 Series rail-mounted terminal blocks; blue	www.wago.com/2009-414/000-006
	Nr. articol: 2009-416 Push-in type wire jumper; insulated; wire length 250 mm; Conductor cross section 1.5 mm ² ; suitable for 2001, 2002, 2003 and 2022 Series rail-mounted terminal blocks; black	www.wago.com/2009-416
Carrier rail		
	Nr. articol: 210-112 Steel carrier rail; 35 x 7.5 mm; 1 mm thick; 2 m long; slotted; according to EN 60715; "Hole width 25 mm	www.wago.com/210-112
	Nr. articol: 210-113 Steel carrier rail; 35 x 7.5 mm; 1 mm thick; 2 m long; unslotted; according to EN 60715	www.wago.com/210-113
	Nr. articol: 210-114 Steel carrier rail; 35 x 15 mm; 1.5 mm thick; 2 m long; unslotted; similar to EN 60715	www.wago.com/210-114
	Nr. articol: 210-115 Steel carrier rail; 35 x 7.5 mm; 1 mm thick; 2 m long; slotted; according to EN 60715; "Hole width 18 mm	www.wago.com/210-115
	Nr. articol: 210-118 Steel carrier rail; 35 x 15 mm; 2.3 mm thick; 2 m long; unslotted; according to EN 60715	www.wago.com/210-118
	Nr. articol: 210-196 Aluminum carrier rail; 35 x 8.2 mm; 1.6 mm thick; 2 m long; unslotted; similar to EN 60715; silver-colored	www.wago.com/210-196
	Nr. articol: 210-197 Steel carrier rail; 35 x 15 mm; 1.5 mm thick; 2 m long; slotted; similar to EN 60715	www.wago.com/210-197

Supus modificărilor.

WAGO Kontakttechnik GmbH & Co. KG
/Representative Office Romania
Sos. Pipera-Tunari nr. 1/1
building 1, 2nd floor | 077190 Voluntari, Ilfov
Tel.: +40-(0)31 421 85 68 | Email: info-RO@wago.com















Aveți întrebări despre produsele noastre?
Vă stăm la dispoziție pentru preluarea apelului la +40 (0) 31 421 85 68.

	Nr. articol: 210-198 Copper carrier rail; 35 x 15 mm; 2.3 mm thick; 2 m long; unslotted; according to EN 60715; copper-colored	www.wago.com/210-198
	Nr. articol: 210-504 Steel carrier rail; 35 x 7.5 mm; 1 mm thick; 2 m long; slotted; galvanized; according to EN 60715	www.wago.com/210-504
	Nr. articol: 210-505 Steel carrier rail; 35 x 7.5 mm; 1 mm thick; 2 m long; unslotted; galvanized; according to EN 60715	www.wago.com/210-505
	Nr. articol: 210-506 Steel carrier rail; 35 x 15 mm; 1.5 mm thick; 2 m long; unslotted; galvanized; similar to EN 60715	www.wago.com/210-506
	Nr. articol: 210-508 Steel carrier rail; 35 x 15 mm; 1.5 mm thick; 2 m long; slotted; galvanized; similar to EN 60715	www.wago.com/210-508
End plate		
	Nr. articol: 2002-3291 End and intermediate plate; 0.8 mm thick; gray	www.wago.com/2002-3291
	Nr. articol: 2002-3292 End and intermediate plate; 0.8 mm thick; orange	www.wago.com/2002-3292
Protective Warning Marker		
	Nr. articol: 2002-115 Protective warning marker; with high-voltage symbol, black; for 5 terminal blocks; yellow	www.wago.com/2002-115
Insulation stop		
	Nr. articol: 2002-171 Insulation stop; 0.25 - 0.5 mm ² ; 5 pieces/strip; light gray	www.wago.com/2002-171
	Nr. articol: 2002-172 Insulation stop; 0.75 - 1 mm ² ; 5 pieces/strip; dark gray	www.wago.com/2002-172
Jumper		
	Nr. articol: 2002-400 Adjacent jumper for continuous commoning; insulated; 2-way; Nominal current 25 A; light gray	www.wago.com/2002-400
	Nr. articol: 2002-402 Push-in type jumper bar; insulated; 2-way; Nominal current 25 A; light gray	www.wago.com/2002-402
	Nr. articol: 2002-402/000-005 Push-in type jumper bar; insulated; 2-way; Nominal current 25 A; red	www.wago.com/2002-402/000-005
	Nr. articol: 2002-402/000-006 Push-in type jumper bar; insulated; 2-way; Nominal current 25 A; blue	www.wago.com/2002-402/000-006
	Nr. articol: 2002-403 Push-in type jumper bar; insulated; 3-way; Nominal current 25 A; light gray	www.wago.com/2002-403

Supus modificărilor.

WAGO Kontakttechnik GmbH & Co. KG
/Representative Office Romania
Sos. Pipera-Tunari nr. 1/1
building 1, 2nd floor | 077190 Voluntari, Ilfov
Tel.: +40-(0)31 421 85 68 | Email: info-RO@wago.com

Aveți întrebări despre produsele noastre?
Vă stăm la dispoziție pentru preluarea apelului la +40 (0) 31 421 85 68.

	Nr. articol: 2002-403/000-005 Push-in type jumper bar; insulated; 3-way; Nominal current 25 A; red	www.wago.com/2002-403/000-005
	Nr. articol: 2002-403/000-006 Push-in type jumper bar; insulated; 3-way; Nominal current 25 A; blue	www.wago.com/2002-403/000-006
	Nr. articol: 2002-404 Push-in type jumper bar; insulated; 4-way; Nominal current 25 A; light gray	www.wago.com/2002-404
	Nr. articol: 2002-404/000-005 Push-in type jumper bar; insulated; 4-way; Nominal current 25 A; red	www.wago.com/2002-404/000-005
	Nr. articol: 2002-404/000-006 Push-in type jumper bar; insulated; 4-way; Nominal current 25 A; blue	www.wago.com/2002-404/000-006
	Nr. articol: 2002-405 Push-in type jumper bar; insulated; 5-way; Nominal current 25 A; light gray	www.wago.com/2002-405
	Nr. articol: 2002-405/000-005 Push-in type jumper bar; insulated; 5-way; Nominal current 25 A; red	www.wago.com/2002-405/000-005
	Nr. articol: 2002-405/000-006 Push-in type jumper bar; insulated; 5-way; Nominal current 25 A; blue	www.wago.com/2002-405/000-006
	Nr. articol: 2002-405/011-000 Star point jumper; insulated; 3-way (1-3-5); IN = IN terminal block; light gray	www.wago.com/2002-405/011-000
	Nr. articol: 2002-406 Push-in type jumper bar; insulated; 6-way; Nominal current 25 A; light gray	www.wago.com/2002-406
	Nr. articol: 2002-406/000-005 Push-in type jumper bar; insulated; 6-way; Nominal current 25 A; red	www.wago.com/2002-406/000-005
	Nr. articol: 2002-406/000-006 Push-in type jumper bar; insulated; 6-way; Nominal current 25 A; blue	www.wago.com/2002-406/000-006
	Nr. articol: 2002-406/020-000 Delta jumper; insulated; 1-2 3-4 5-6; IN = IN terminal block; light gray	www.wago.com/2002-406/020-000
	Nr. articol: 2002-407 Push-in type jumper bar; insulated; 7-way; Nominal current 25 A; light gray	www.wago.com/2002-407

Supus modificărilor.



Nr. articol: 2002-407/000-005
Push-in type jumper bar; insulated; 7-way; Nominal current 25 A; red

www.wago.com/2002-407/000-005



Nr. articol: 2002-407/000-006
Push-in type jumper bar; insulated; 7-way; Nominal current 25 A; blue

www.wago.com/2002-407/000-006



Nr. articol: 2002-408
Push-in type jumper bar; insulated; 8-way; Nominal current 25 A; light gray

www.wago.com/2002-408



Nr. articol: 2002-408/000-005
Push-in type jumper bar; insulated; 8-way; Nominal current 25 A; red

www.wago.com/2002-408/000-005



Nr. articol: 2002-408/000-006
Push-in type jumper bar; insulated; 8-way; Nominal current 25 A; blue

www.wago.com/2002-408/000-006



Nr. articol: 2002-409
Push-in type jumper bar; insulated; 9-way; Nominal current 25 A; light gray

www.wago.com/2002-409



Nr. articol: 2002-409/000-005
Push-in type jumper bar; insulated; 9-way; Nominal current 25 A; red

www.wago.com/2002-409/000-005



Nr. articol: 2002-409/000-006
Push-in type jumper bar; insulated; 9-way; Nominal current 25 A; blue

www.wago.com/2002-409/000-006



Nr. articol: 2002-410
Push-in type jumper bar; insulated; 10-way; Nominal current 25 A; light gray

www.wago.com/2002-410



Nr. articol: 2002-410/000-005
Push-in type jumper bar; insulated; 10-way; Nominal current 25 A; red

www.wago.com/2002-410/000-005



Nr. articol: 2002-410/000-006
Push-in type jumper bar; insulated; 10-way; Nominal current 25 A; blue

www.wago.com/2002-410/000-006



Nr. articol: 2002-423
Adjacent jumper for continuous commoning; insulated; from 1 to 3; Nominal current 25 A; light gray

www.wago.com/2002-423



Nr. articol: 2002-423/000-005
Adjacent jumper for continuous commoning; insulated; from 1 to 3; Nominal current 25 A; red

www.wago.com/2002-423/000-005



Nr. articol: 2002-423/000-006
Adjacent jumper for continuous commoning; insulated; from 1 to 3; Nominal current 25 A; blue

www.wago.com/2002-423/000-006

Supus modificărilor.

	Nr. articol: 2002-433 Push-in type jumper bar; insulated; from 1 to 3; Nominal current 25 A; light gray	www.wago.com/2002-433
	Nr. articol: 2002-434 Push-in type jumper bar; insulated; from 1 to 4; Nominal current 25 A; light gray	www.wago.com/2002-434
	Nr. articol: 2002-435 Push-in type jumper bar; insulated; from 1 to 5; Nominal current 25 A; light gray	www.wago.com/2002-435
	Nr. articol: 2002-436 Push-in type jumper bar; insulated; from 1 to 6; Nominal current 25 A; light gray	www.wago.com/2002-436
	Nr. articol: 2002-437 Push-in type jumper bar; insulated; from 1 to 7; Nominal current 25 A; light gray	www.wago.com/2002-437
	Nr. articol: 2002-438 Push-in type jumper bar; insulated; from 1 to 8; Nominal current 25 A; light gray	www.wago.com/2002-438
	Nr. articol: 2002-439 Push-in type jumper bar; insulated; from 1 to 9; Nominal current 25 A; light gray	www.wago.com/2002-439
	Nr. articol: 2002-440 Push-in type jumper bar; insulated; from 1 to 10; Nominal current 25 A; light gray	www.wago.com/2002-440
	Nr. articol: 2002-472 Staggered jumper; insulated; 2-way; Nominal current 25 A; suitable for 2002 and 2003 Series rail-mounted terminal blocks; light gray	www.wago.com/2002-472
	Nr. articol: 2002-473 Staggered jumper; insulated; 3-way; Nominal current 25 A; suitable for 2002 and 2003 Series rail-mounted terminal blocks; light gray	www.wago.com/2002-473
	Nr. articol: 2002-473/011-000 Ready-made staggered jumper; insulated; 2-way (1-3); Nominal current 25 A; with contact lugs broken off at the factory and circuit marking; light gray	www.wago.com/2002-473/011-000
	Nr. articol: 2002-474 Staggered jumper; insulated; 4-way; Nominal current 25 A; suitable for 2002 and 2003 Series rail-mounted terminal blocks; light gray	www.wago.com/2002-474
	Nr. articol: 2002-475 Staggered jumper; insulated; 5-way; Nominal current 25 A; suitable for 2002 and 2003 Series rail-mounted terminal blocks; light gray	www.wago.com/2002-475
	Nr. articol: 2002-475/011-000 Ready-made staggered jumper; insulated; 3-way (1-3-5); Nominal current 25 A; with contact lugs broken off at the factory and circuit marking; light gray	www.wago.com/2002-475/011-000
	Nr. articol: 2002-476 Staggered jumper; insulated; 6-way; Nominal current 25 A; suitable for 2002 and 2003 Series rail-mounted terminal blocks; light gray	www.wago.com/2002-476
	Nr. articol: 2002-477 Staggered jumper; insulated; 7-way; Nominal current 25 A; suitable for 2002 and 2003 Series rail-mounted terminal blocks; light gray	www.wago.com/2002-477

Supus modificărilor.

WAGO Kontakttechnik GmbH & Co. KG
/Representative Office Romania
Sos. Pipera-Tunari nr. 1/1
building 1, 2nd floor | 077190 Voluntari, Ilfov
Tel.: +40-(0)31 421 85 68 | Email: info-RO@wago.com

Aveți întrebări despre produsele noastre?
Vă stăm la dispoziție pentru preluarea apelului la +40 (0) 31 421 85 68.

**Nr. articol: 2002-477/011-000**

Ready-made staggered jumper; insulated; 1-3-5-7; Nominal current 25 A; with contact lugs broken off at the factory and circuit marking; light gray

www.wago.com/2002-477/011-000**Nr. articol: 2002-478**

Staggered jumper; insulated; 8-way; Nominal current 25 A; suitable for 2002 and 2003 Series rail-mounted terminal blocks; light gray

www.wago.com/2002-478**Nr. articol: 2002-479**

Staggered jumper; insulated; 9-way; Nominal current 25 A; suitable for 2002 and 2003 Series rail-mounted terminal blocks; light gray

www.wago.com/2002-479**Nr. articol: 2002-479/011-000**

Ready-made staggered jumper; insulated; 1-3-5-7-9; Nominal current 25 A; with contact lugs broken off at the factory and circuit marking; light gray

www.wago.com/2002-479/011-000**Nr. articol: 2002-480**

Staggered jumper; insulated; 10-way; Nominal current 25 A; suitable for 2002 and 2003 Series rail-mounted terminal blocks; light gray

www.wago.com/2002-480**Nr. articol: 2002-481**

Staggered jumper; insulated; 11-way; Nominal current 25 A; suitable for 2002 and 2003 Series rail-mounted terminal blocks; light gray

www.wago.com/2002-481**Nr. articol: 2002-481/011-000**

Ready-made staggered jumper; insulated; 1-3-5-7-9-11; Nominal current 25 A; with contact lugs broken off at the factory and circuit marking; light gray

www.wago.com/2002-481/011-000**Nr. articol: 2002-482**

Staggered jumper; insulated; 12-way; Nominal current 25 A; suitable for 2002 and 2003 Series rail-mounted terminal blocks; light gray

www.wago.com/2002-482**Nr. articol: 2002-492**

Double-deck vertical jumper; insulated; light gray

www.wago.com/2002-492**Nr. articol: 2002-492/000-012**

Double-deck vertical jumper; insulated; orange

www.wago.com/2002-492/000-012**Nr. articol: 2002-493**

Triple-deck vertical jumper; insulated; light gray

www.wago.com/2002-493**Nr. articol: 210-103**

Wire commoning chain; insulated; 50 connections; black

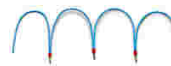
www.wago.com/210-103**Nr. articol: 210-123**

Wire commoning chain; insulated; 50 connections

www.wago.com/210-123**tools****Nr. articol: 210-658**

Operating tool; Blade: 3.5 x 0.5 mm; with a partially insulated shaft; angled; short

www.wago.com/210-658**Nr. articol: 210-720**

Operating tool; Blade: 3.5 x 0.5 mm; with a partially insulated shaft

www.wago.com/210-720

Supus modificărilor.

Descărcări Documentation

Additional Information

Technical explanations

Apr 3, 2019

pdf
2,1 MB

Descărcare

CAD/CAE-Data

CAD data

2D/3D Models 2002-3248

URL

Descărcare

CAE data

EPLAN Data Portal 2002-3248

URL

Descărcare

WSCAD Universe 2002-3248

URL

Descărcare

Installation Notes

Conductor termination

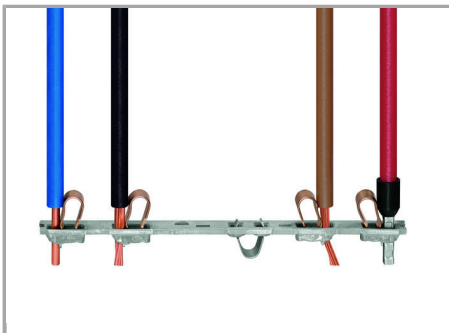

All conductor types at a glance

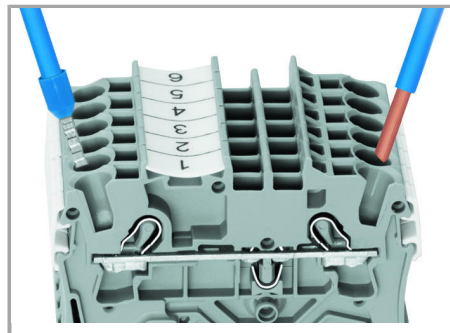

Terminating solid and ferruled conductors via push-in connection.

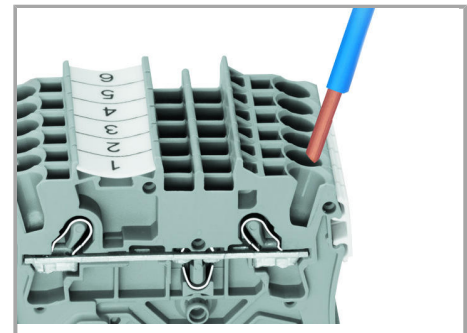

Inserting conductors via push-in termination.

Solid conductors with cross-sections from either one size above, or up to two sizes below, the rated cross-section can be simply pushed in – no tools needed.

Supus modificărilor.



Inserting a conductor via operating tool.



Conductor termination – Insulation stop.

Connecting fine-stranded conductors without ferrules, or small cross-sectional conductors that cannot be pushed in, is performed similarly to the original CAGE CLAMP® – just use an operating tool.

The smart feature:

To open the clamp, the operating tool is inserted vertically. The conductor entry is less than 15 degrees for easier wiring.

Jumpered

Supus modificărilor.

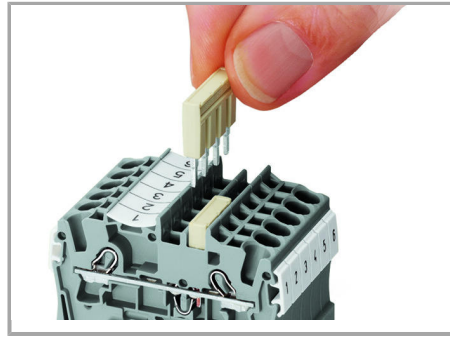
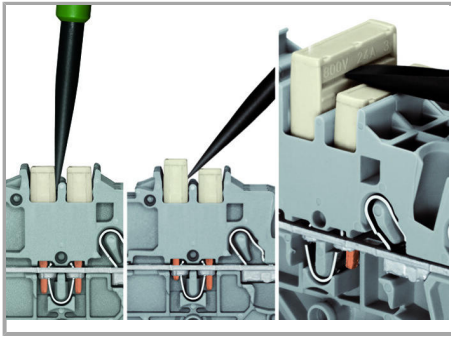

Removing a push-in type jumper bar.

Insert the operating tool between the jumper and the partition wall of the dual jumper slots, then lift up the jumper.

Place the operating tool in the center of jumpers up to five contacts (see above), or alternately on both sides for jumpers with more than five contacts.

The push-in type jumper bar system is based on the common plug and socket principle. Each terminal block is spring-loaded with a double socket and a resilient CrNi steel spring. The jumper contact material is pure electrolytic copper, which allows for an extremely small design capable of carrying the full-rated current of the terminal block. Ground terminal blocks can also be commoned using the same jumper system. Custom jumpers are created by breaking and removing jumper contacts (2000, 2001, 2002, 2004 Series).

Jumpered

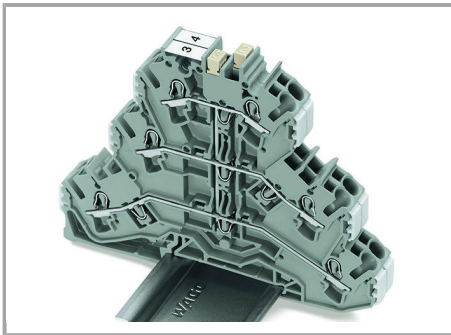

Commoning three levels via triple-deck vertical jumper (2002-493).

Created for double- and triple-deck TOPJOB® S Terminal Blocks, the vertical jumpers can common two or three levels. Clearly marked numerals ("2" and "3") distinguish the double-deck (2002-492) and triple-deck vertical jumpers (2002-493), even when inserted.

Familie de produse

Supus modificărilor.

WAGO Kontakttechnik GmbH & Co. KG
/Representative Office Romania
Sos. Pipera-Tunari nr. 1/1
building 1, 2nd floor | 077190 Voluntari, Ilfov
Tel.: +40-(0)31 421 85 68 | Email: info-RO@wago.com

Aveți întrebări despre produsele noastre?
Vă stăm la dispoziție pentru preluarea apelului la +40 (0) 31 421 85 68.



TOPJOB® S

TOPJOB® S: In various industrial applications and modern building installations, WAGO's wide and versatile range of rail-mount terminal blocks provides more than just reliable electrical connections.

Afișare globală produse din familie.

Supus modificărilor.

WAGO Kontakttechnik GmbH & Co. KG
/Representative Office Romania
Sos. Pipera-Tunari nr. 1/1
building 1, 2nd floor | 077190 Voluntari, Ilfov
Tel.: +40-(0)31 421 85 68 | Email: info-RO@wago.com

Aveți întrebări despre produsele noastre?
Vă stăm la dispoziție pentru preluarea apelului la +40 (0) 31 421 85 68.