

## Fișă tehnică | Număr articol: 713-1408/107-000

THT male header, 2-row; 0.8 x 0.8 mm solder pin; straight; 100% protected against mismatching; Threaded flange; Pin spacing 3.5 mm; 2 x 8-pole; black

[www.wago.com/713-1408/107-000](http://www.wago.com/713-1408/107-000)



Supus modificărilor.

WAGO Kontakttechnik GmbH & Co. KG  
/Representative Office Romania  
Sos. Pipera-Tunari nr. 1/1  
building 1, 2nd floor | 077190 Voluntari, Ilfov  
Tel.: +40-(0)31 421 85 68 | Email: info-RO@wago.com

Aveți întrebări despre produsele noastre?  
Vă stăm la dispoziție pentru preluarea apelului la +40 (0) 31 421 85 68.

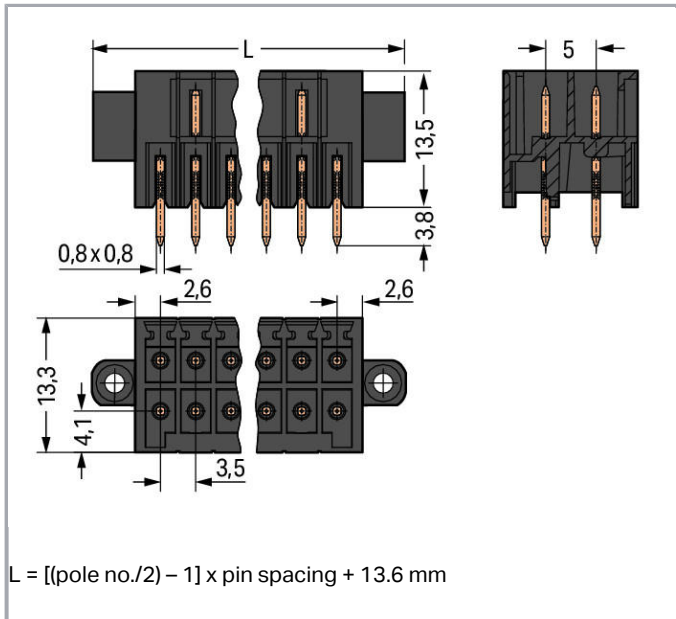

## Descriere articol

- Male headers may be mounted horizontally or vertically via straight or angled solder pins
- Header housing is molded of THT-compatible insulation material for lead-free reflow soldering
- Separated pin slots prevent damage and make the headers touch-proof when unplugged
- 100% protected against mismatching
- Coding pins available

## Safety information 1:

The *MULTI CONNECTION SYSTEM (MCS)* is designed without breaking capacity for compliance with DIN EN 61984. When used as intended, MCS Connectors shall not be connected/disconnected when live or under load. The circuit design should ensure header pins, which can be touched, are not live when unmated.

## Date

## Electrical data

## Ratings per IEC/EN 60664-1

Ratings per	IEC/EN 60664-1
Nominal voltage (III/3)	80 V
Rated surge voltage (III/3)	2,5 kV
Rated voltage (III/2)	160 V
Rated surge voltage (III/2)	2,5 kV

Supus modificărilor.

WAGO Kontakttechnik GmbH & Co. KG  
 /Representative Office Romania  
 Sos. Pipera-Tunari nr. 1/1  
 building 1, 2nd floor | 077190 Voluntari, Ilfov  
 Tel.: +40-(0)31 421 85 68 | Email: info-RO@wago.com

Aveți întrebări despre produsele noastre?  
 Vă stăm la dispoziție pentru preluarea apelului la +40 (0) 31 421 85 68.



Nominal voltage (II/2)	250 V
Rated surge voltage (II/2)	2,5 kV
Rated current	10 A
Legend (ratings)	(III / 2) $\triangleq$ Overvoltage category III / Pollution degree 2

**Approvals per UL 1059**

Rated voltage UL (Use Group B)	150 V
Rated current UL (Use Group B)	10 A
Rated voltage UL (Use Group C)	50 V
Rated current UL (Use Group C)	10 A
Approvals per	UL 1059

**Approvals per CSA**

Rated voltage CSA (Use Group B)	150 V
Rated current CSA (Use Group B)	12 A

**Connection data**

Pole No.	16
Total number of potentials	16
Number of connection types	1
Number of levels	2

**Geometrical Data**

Pin spacing	3.5 mm / 0.138 inch
Width	38.1 mm / 1.5 inch
Height	17.3 mm / 0.681 inch
Height from the surface	13.5 mm / 0.531 inch
Depth	13.3 mm / 0.524 inch
Solder pin length	3,8 mm
Solder pin dimensions	0.8 x 0.8 mm
Drilled hole diameter with tolerance	1.2 <sup>(+0.1)</sup> mm

**Plug connection**

Contact type (pluggable connector)	Male connector/plug
Connector (connection type)	for PCBs
Mismating protection	Yes

Supus modificărilor.

Mating direction to the PCB	90°
Locking of plug-in connection	Threaded flange

### PCB contact

PCB contact	THT
Solder pin arrangement	over the entire male connector, in line
Number of solder pins per potential	1

### Material Data

Color	black
Material group	I
Insulation material	Polyphthalamide (PPA GF)
Flammability class per UL94	V0
Contact material	Electrolytic copper (E <sub>Cu</sub> )
Contact plating	tin-plated
Fire load	0,095 MJ
Weight	4,9 g

### Environmental Requirements

Limit temperature range	-60 ... +100 °C
-------------------------	-----------------

### Commercial data

Product Group	3 (Multi Conn. System)
Packaging type	BOX
Country of origin	PL
GTIN	4045454808976
Customs tariff number	85366990990

### Aprobări / certificate

#### Country specific Approvals

Embleă	Aprobare	Text de aprobare suplimentar	Nume certificat
	CCA DEKRA Certification B.V.	EN 61984	2169947.01
	CSA	C22.2 No. 158	2315087

Supus modificărilor.







DEKRA Certification B.V.

## UL-Approvals

Emblemă	Aprobare	Text de aprobare suplimentar	Nume certificat
	UL Underwriters Laboratories Inc.	UL 1059	20190122- E45172

## Counterpart

	<b>Nr. articol</b> 713-1108/107-000 1-conductor female plug; 100% protected against mismatching; Screw flange; 1.5 mm <sup>2</sup> ; Pin spacing 3.5 mm; 16-pole; 1,50 mm <sup>2</sup> ; black	<a href="http://www.wago.com/713-1108/107-000">www.wago.com/713-1108/107-000</a>
	<b>Nr. articol</b> 713-1108/107-047/033-000 1-conductor female connector, 2-row; 100% protected against mismatching; Screw flange; Strain relief plate; direct marking; 1.5 mm <sup>2</sup> ; Pin spacing 3.5 mm; 16-pole; 1,50 mm <sup>2</sup> ; black	<a href="http://www.wago.com/713-1108/107-047/033-000">www.wago.com/713-1108/107-047/033-000</a>
	<b>Nr. articol</b> 713-1108/107-047 1-conductor female connector, 2-row; 100% protected against mismatching; Screw flange; direct marking; 1.5 mm <sup>2</sup> ; Pin spacing 3.5 mm; 16-pole; 1,50 mm <sup>2</sup> ; black	<a href="http://www.wago.com/713-1108/107-047">www.wago.com/713-1108/107-047</a>
	<b>Nr. articol</b> 713-1108/107-9037 1-conductor female connector, 2-row; 100% protected against mismatching; Screw flange; direct marking; 1.5 mm <sup>2</sup> ; Pin spacing 3.5 mm; 16-pole; 1,50 mm <sup>2</sup> ; black	<a href="http://www.wago.com/713-1108/107-9037">www.wago.com/713-1108/107-9037</a>
	<b>Nr. articol</b> 713-1108/107-9037/033-000 1-conductor female connector, 2-row; 100% protected against mismatching; Screw flange; Strain relief plate; direct marking; 1.5 mm <sup>2</sup> ; Pin spacing 3.5 mm; 16-pole; 1,50 mm <sup>2</sup> ; black	<a href="http://www.wago.com/713-1108/107-9037/033-000">www.wago.com/713-1108/107-9037/033-000</a>

## Produse compatibile

## Coding

	<b>Nr. articol:</b> 714-101 Coding key; orange	<a href="http://www.wago.com/714-101">www.wago.com/714-101</a>
--	---	--

Supus modificărilor.

WAGO Kontakttechnik GmbH & Co. KG  
/Representative Office Romania  
Sos. Pipera-Tunari nr. 1/1  
building 1, 2nd floor | 077190 Voluntari, Ilfov  
Tel.: +40-(0)31 421 85 68 | Email: info-RO@wago.com

Aveți întrebări despre produsele noastre?  
Vă stăm la dispoziție pentru preluarea apelului la +40 (0) 31 421 85 68.



## Descărcări

### Documentation

#### Additional Information

Technical explanations	Apr 3, 2019	pdf 3,6 MB	Descărcare
------------------------	-------------	---------------	------------

### CAD/CAE-Data

#### CAD data

2D/3D Models 713-1408/107-000	URL	Descărcare
-------------------------------	-----	------------

#### PCB Design

Symbol and Footprint 713-1408/107-000	URL	Descărcare
---------------------------------------	-----	------------

CAX data for your PCB design, consisting of "schematic symbols and PCB footprints", allow easy integration of the WAGO component into your development environment.

#### Supported formats:

- Accel EDA 14 & 15
- Altium 6 to current version
- Cadence Allegro
- DesignSpark
- Eagle Libraries
- KiCad
- Mentor Graphics BoardStation
- Mentor Graphics Design Architect
- Mentor Graphics Design Expedition 99 and 2000
- OrCAD 9.X PCB and Capture
- PADS PowerPCB 3, 3.5, 4.X, and 5.X
- PADS PowerPCB and PowerLogic 3.0
- PCAD 2000, 2001, 2002, 2004, and 2006
- Pulsonix 8.5 or newer
- STL
- 3D STEP
- TARGET 3001!
- View Logic ViewDraw
- Quadcept

Supus modificărilor.

WAGO Kontakttechnik GmbH & Co. KG  
/Representative Office Romania  
Sos. Pipera-Tunari nr. 1/1  
building 1, 2nd floor | 077190 Voluntari, Ilfov  
Tel.: +40-(0)31 421 85 68 | Email: info-RO@wago.com

Aveți întrebări despre produsele noastre?  
Vă stăm la dispoziție pentru preluarea apelului la +40 (0) 31 421 85 68.

- Zuken CadStar 3 and 4
- Zuken CR-5000 and CR-8000

PCB Component Libraries (EDA), PCB CAD Library Ultra Librarian

---

## Installation Notes

### Coding

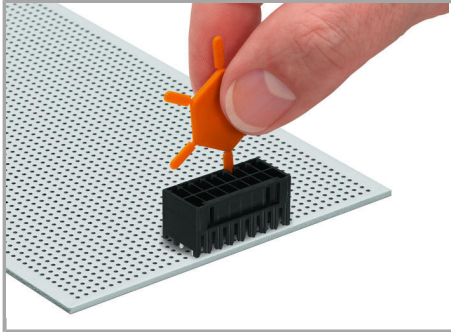

Coding a male header by inserting a coding pin.

## Familie de produse

<i>MCS</i> MINI HD

Afișare globală produse din familie.

Supus modificărilor.

---

WAGO Kontakttechnik GmbH & Co. KG  
/Representative Office Romania  
Sos. Pipera-Tunari nr. 1/1  
building 1, 2nd floor | 077190 Voluntari, Ilfov  
Tel.: +40-(0)31 421 85 68 | Email: [info-RO@wago.com](mailto:info-RO@wago.com)

Aveți întrebări despre produsele noastre?  
Vă stăm la dispoziție pentru preluarea apelului la +40 (0) 31 421 85 68.