

## Fișă tehnică | Număr articol: 769-632/007-000

THT male header; 1.0 x 1.0 mm solder pin; straight; clamping collar; Pin spacing 5 mm; 2-pole; gray

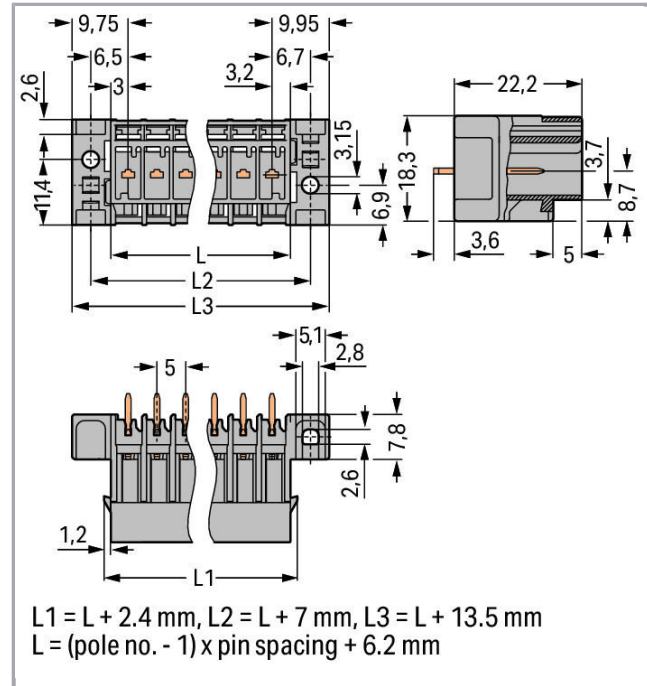

[www.wago.com/769-632/007-000](http://www.wago.com/769-632/007-000)

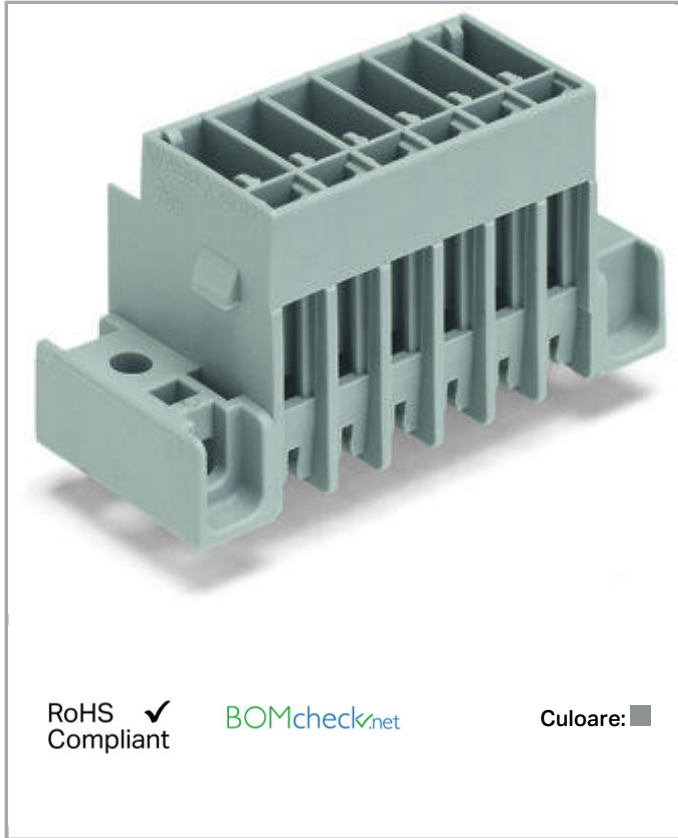

RoHS  Compliant

BOMcheck.net

Culoare: ■

### Date

### Electrical data

### Ratings per IEC/EN 60664-1

Nominal voltage (III/3)	250 V
Rated surge voltage (III/3)	4 kV
Rated voltage (III/2)	500 V
Rated surge voltage (III/2)	4 kV
Rated current	32 A
Legend (ratings)	(III / 3) ≙ Overvoltage category III / Pollution degree 3

Supus modificărilor.

WAGO Kontakttechnik GmbH & Co. KG  
/Representative Office Romania  
Sos. Pipera-Tunari nr. 1/1  
building 1, 2nd floor | 077190 Voluntari, Ilfov  
Tel.: +40-(0)31 421 85 68 | Email: info-RO@wago.com

Aveți întrebări despre produsele noastre?  
Vă stăm la dispoziție pentru preluarea apelului la +40 (0) 31 421 85 68.

**Connection data**

Pole No.	2
Total number of potentials	2
Number of levels	1

**Geometrical Data**

Pin spacing	5 mm / 0.197 inch
Width	24,7 mm / 0.972 inch
Height from the surface	22,2 mm / 0.874 inch
Depth	18,3 mm / 0.72 inch

**Mechanical data**

Mounting type	Mounting flange
---------------	-----------------

**Plug connection**

Contact type (pluggable connector)	Male connector/plug
Connector (connection type)	for PCB
Mismating protection	No
Mating direction to the PCB	90°

**PCB contact**

PCB contact	THT
-------------	-----

**Material Data**

Color	gray
Insulation material	Polyamide 66 (PA 66)
Fire load	0,095 MJ
Weight	3,8 g

**Commercial data**

Packaging type	BOX
Country of origin	PL
GTIN	4050821477006
Customs tariff number	85366990990

Supus modificărilor.

WAGO Kontakttechnik GmbH & Co. KG  
 /Representative Office Romania  
 Sos. Pipera-Tunari nr. 1/1  
 building 1, 2nd floor | 077190 Voluntari, Ilfov  
 Tel.: +40-(0)31 421 85 68 | Email: info-RO@wago.com



Aveți întrebări despre produsele noastre?  
 Vă stăm la dispoziție pentru preluarea apelului la +40 (0) 31 421 85 68.

## Aprobări / certificate

## Country specific Approvals

Embleă	Aprobare	Text de aprobare suplimentar	Nume certificat
	CSA DEKRA Certification B.V.	C22.2 No. 158	1101144

## UL-Approvals

Embleă	Aprobare	Text de aprobare suplimentar	Nume certificat
	UR Underwriters Laboratories Inc.	UL 1977	20151210- E45171
	UR Underwriters Laboratories Inc.	UL 1059	20190731- E45172

## Counterpart

## Produse compatibile

## Coding

	<b>Nr. articol: 769-435</b> Coding pin; for coding of female plugs; for carrier terminal blocks / male connectors; orange	<a href="http://www.wago.com/769-435">www.wago.com/769-435</a>
--	--	--

## Female plug

	<b>Nr. articol: 769-101</b> 1-conductor female plug; 4 mm <sup>2</sup> ; 1-pole; 4,00 mm <sup>2</sup> ; gray	<a href="http://www.wago.com/769-101">www.wago.com/769-101</a>
	<b>Nr. articol: 769-102</b> 1-conductor female plug; 4 mm <sup>2</sup> ; 2-pole; 4,00 mm <sup>2</sup> ; gray	<a href="http://www.wago.com/769-102">www.wago.com/769-102</a>
	<b>Nr. articol: 769-102/000-036</b> 1-conductor female plug; 4 mm <sup>2</sup> ; 2-pole; 4,00 mm <sup>2</sup> ; gray, green-yellow	<a href="http://www.wago.com/769-102/000-036">www.wago.com/769-102/000-036</a>
	<b>Nr. articol: 769-102/000-037</b> 1-conductor female plug; 4 mm <sup>2</sup> ; 2-pole; 4,00 mm <sup>2</sup> ; green-yellow, gray	<a href="http://www.wago.com/769-102/000-037">www.wago.com/769-102/000-037</a>

Supus modificărilor.

WAGO Kontakttechnik GmbH & Co. KG  
/Representative Office Romania  
Sos. Pipera-Tunari nr. 1/1  
building 1, 2nd floor | 077190 Voluntari, Ilfov  
Tel.: +40-(0)31 421 85 68 | Email: info-RO@wago.com

Aveți întrebări despre produsele noastre?  
Vă stăm la dispoziție pentru preluarea apelului la +40 (0) 31 421 85 68.



Nr. articol: 769-102/021-000

1-conductor female plug; Locking lever; 4 mm<sup>2</sup>; 2-pole; 4,00 mm<sup>2</sup>; gray[www.wago.com/769-102/021-000](http://www.wago.com/769-102/021-000)

Nr. articol: 769-121

2-conductor female connector; 4 mm<sup>2</sup>; 1-pole; 4,00 mm<sup>2</sup>; gray[www.wago.com/769-121](http://www.wago.com/769-121)

Nr. articol: 769-122

2-conductor female connector; 4 mm<sup>2</sup>; 2-pole; 4,00 mm<sup>2</sup>; gray[www.wago.com/769-122](http://www.wago.com/769-122)

## Descărcări

### Documentation

#### Additional Information

Technical explanations	Apr 3, 2019	pdf 2,1 MB	Descărcare
------------------------	-------------	---------------	------------

### CAD/CAE-Data

#### CAD data

2D/3D Models 769-632/007-000	URL	Descărcare
------------------------------	-----	------------

#### PCB Design

Symbol and Footprint 769-632/007-000	URL	Descărcare
--------------------------------------	-----	------------

CAX data for your PCB design, consisting of "schematic symbols and PCB footprints", allow easy integration of the WAGO component into your development environment.

#### Supported formats:

- Accel EDA 14 & 15
- Altium 6 to current version
- Cadence Allegro
- DesignSpark
- Eagle Libraries
- KiCad
- Mentor Graphics BoardStation
- Mentor Graphics Design Architect
- Mentor Graphics Design Expedition 99 and 2000
- OrCAD 9.X PCB and Capture
- PADS PowerPCB 3, 3.5, 4.X, and 5.X

Supus modificărilor.

WAGO Kontakttechnik GmbH & Co. KG  
 /Representative Office Romania  
 Sos. Pipera-Tunari nr. 1/1  
 building 1, 2nd floor | 077190 Voluntari, Ilfov  
 Tel.: +40-(0)31 421 85 68 | Email: info-RO@wago.com

Aveți întrebări despre produsele noastre?  
 Vă stăm la dispoziție pentru preluarea apelului la +40 (0) 31 421 85 68.

- PADS PowerPCB and PowerLogic 3.0
- PCAD 2000, 2001, 2002, 2004, and 2006
- Pulsonix 8.5 or newer
- STL
- 3D STEP
- TARGET 3001!
- View Logic ViewDraw
- Quadcept
- Zuken CadStar 3 and 4
- Zuken CR-5000 and CR-8000

PCB Component Libraries (EDA), PCB CAD Library Ultra Librarian

---

## Installation Notes

### Installation

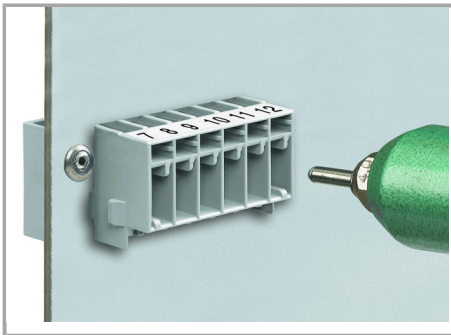

Mounting with 3 mm Ø blind rivets

## Familie de produse

### X-COM

[Afișare globală produse din familie.](#)

Supus modificărilor.