

Fișă tehnică | Număr articol: 231-456

Testing plug module with contact stud; for 736, 737 Series; Pin spacing 7.5 mm / 0.295 in; 2,50 mm²; gray

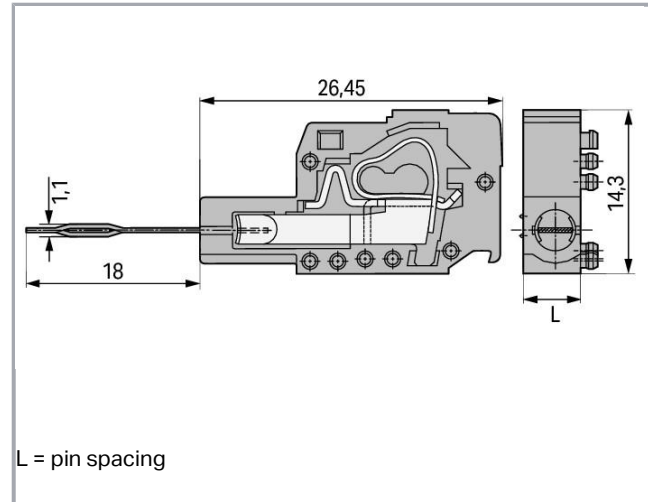

www.wago.com/231-456

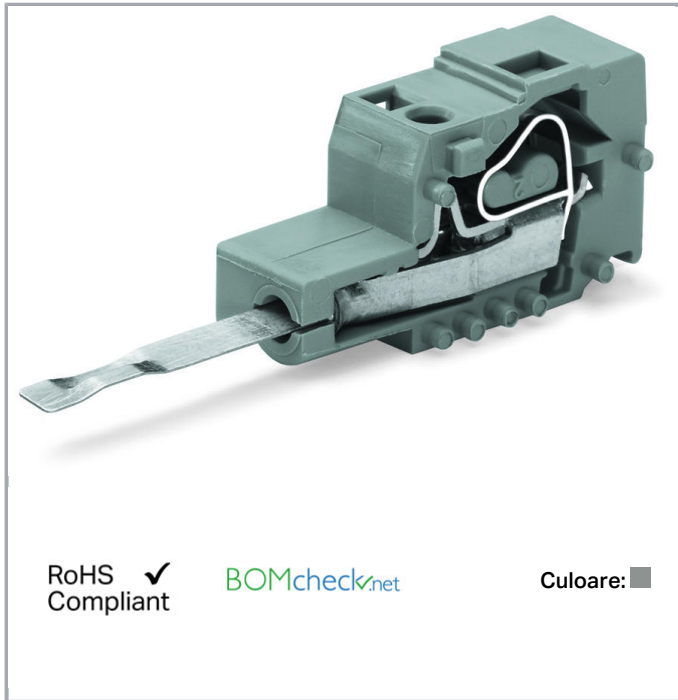

L = pin spacing

RoHS Compliant

BOMcheck.net

Culoare: ■

Date

Electrical data

Ratings per IEC/EN 60664-1

| Ratings per | IEC/EN 60664-1 |
|-----------------------------|---|
| Rated voltage (III/2) | 250 V |
| Rated surge voltage (III/2) | 2,5 kV |
| Rated current | 0,5 A |
| Legend (ratings) | (III / 2) ≙ Overvoltage category III / Pollution degree 2 |

Approvals per UL 1059

| | |
|---------------|---------|
| Approvals per | UL 1059 |
|---------------|---------|

Connection data

| | |
|-----------------------|-------------|
| Connection technology | CAGE CLAMP® |
|-----------------------|-------------|

Supus modificărilor.

WAGO Kontakttechnik GmbH & Co. KG
/Representative Office Romania
Sos. Pipera-Tunari nr. 1/1
building 1, 2nd floor | 077190 Voluntari, Ilfov
Tel.: +40-(0)31 421 85 68 | Email: info-RO@wago.com

Aveți întrebări despre produsele noastre?
Vă stăm la dispoziție pentru preluarea apelului la +40 (0) 31 421 85 68.



| | |
|-----------------------------------|--|
| Solid conductor | 0,08 ... 2,5 mm ² / 28 ... 12 AWG |
| Fine-stranded conductor | 0,08 ... 2,5 mm ² / 28 ... 12 AWG |
| Strip length | 12 ... 13 mm / 0.47 ... 0.51 inch |
| Total number of connection points | 1 |
| Total number of potentials | 1 |
| Number of connection types | 1 |

Geometrical Data

| | |
|-------------|----------------------|
| Pin spacing | 7,5 mm / 0.295 inch |
| Width | 7,5 mm / 0.295 inch |
| Height | 14,3 mm / 0.563 inch |
| Depth | 44,45 mm / 1.75 inch |

Mechanical data

| | |
|---------------------|---|
| Test contact length | 18 mm |
| Application | Testing wired terminal blocks with 0.75 ... 1.5 mm ² "f-st" or 0.5 mm ² "sol." conductors |
| Suitable | for 736, 737 Series |

Material Data

| | |
|-----------------------------|--|
| Color | gray |
| Material group | I |
| Insulation material | Polyamide 66 (PA 66) |
| Flammability class per UL94 | V0 |
| Clamping spring material | Chrome nickel spring steel (CrNi) |
| Contact material | Electrolytic copper (E _{Cu}) |
| Contact plating | tin-plated |
| Weight | 2,2 g |

Environmental Requirements

| | |
|-------------------------|-----------------|
| Limit temperature range | -60 ... +105 °C |
|-------------------------|-----------------|

Commercial data

| | |
|-------------------|------------------------|
| Product Group | 3 (Multi Conn. System) |
| Packaging type | BOX |
| Country of origin | DE |

Supus modificărilor.

WAGO Kontakttechnik GmbH & Co. KG
 /Representative Office Romania
 Sos. Pipera-Tunari nr. 1/1
 building 1, 2nd floor | 077190 Voluntari, Ilfov
 Tel.: +40-(0)31 421 85 68 | Email: info-RO@wago.com

Aveți întrebări despre produsele noastre?
 Vă stăm la dispoziție pentru preluarea apelului la +40 (0) 31 421 85 68.

Customs tariff number

85366990990

Aprobări / certificate

Country specific Approvals

| Embleă | Aprobare | Text de aprobare suplimentar | Nume certificat |
|--|---------------------------------|------------------------------|-----------------|
|  | CSA DEKRA Certification B.V. | C22.2 | 1466354 |



Ship Approvals

| Embleă | Aprobare | Text de aprobare suplimentar | Nume certificat |
|---|-----------------------|------------------------------|----------------------|
|  | LR Lloyds Register | IEC 61984 | 96 /20035 (E5) |

Counterpart

Produse compatibile

tools

| | | |
|--|--|--|
|  | Nr. articol: 210-657 Operating tool; Blade: 3.5 x 0.5 mm; with a partially insulated shaft; short | www.wago.com/210-657 |
|  | Nr. articol: 210-720 Operating tool; Blade: 3.5 x 0.5 mm; with a partially insulated shaft | www.wago.com/210-720 |

Descărcări

Documentation

Additional Information

| | | | |
|------------------------|-------------|---------------|------------|
| Technical explanations | Apr 3, 2019 | pdf 3,6 MB | Descărcare |
|------------------------|-------------|---------------|------------|

Installation Notes

Installation

Supus modificărilor.

WAGO Kontakttechnik GmbH & Co. KG
/Representative Office Romania
Sos. Pipera-Tunari nr. 1/1
building 1, 2nd floor | 077190 Voluntari, Ilfov
Tel.: +40-(0)31 421 85 68 | Email: info-RO@wago.com

Aveți întrebări despre produsele noastre?
Vă stăm la dispoziție pentru preluarea apelului la +40 (0) 31 421 85 68.

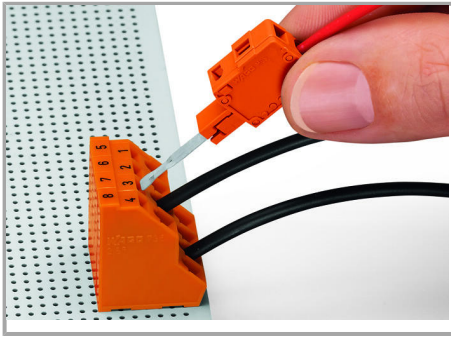

Inserting a test plug module into the operating slot.

Testing

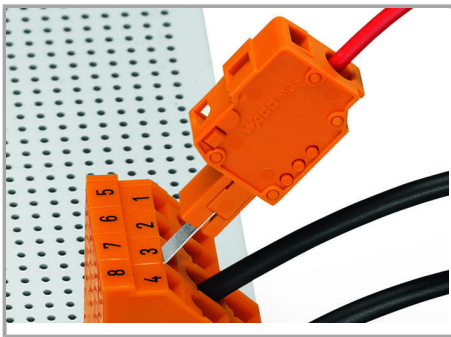

Wired terminal strip with inserted test plug module

Application

Supus modificărilor.



Contact type B:

Testing only when wired –

0.75 ... 1.5 mm² "f-st" or 0.5 mm² "sol."

Supus modificărilor.