

Fișă tehnică | Număr articol: 2003-911

Double fuse plug; for 5 x 20 mm miniature metric fuse; without blown fuse indication; 10.4 mm wide; gray

www.wago.com/2003-911

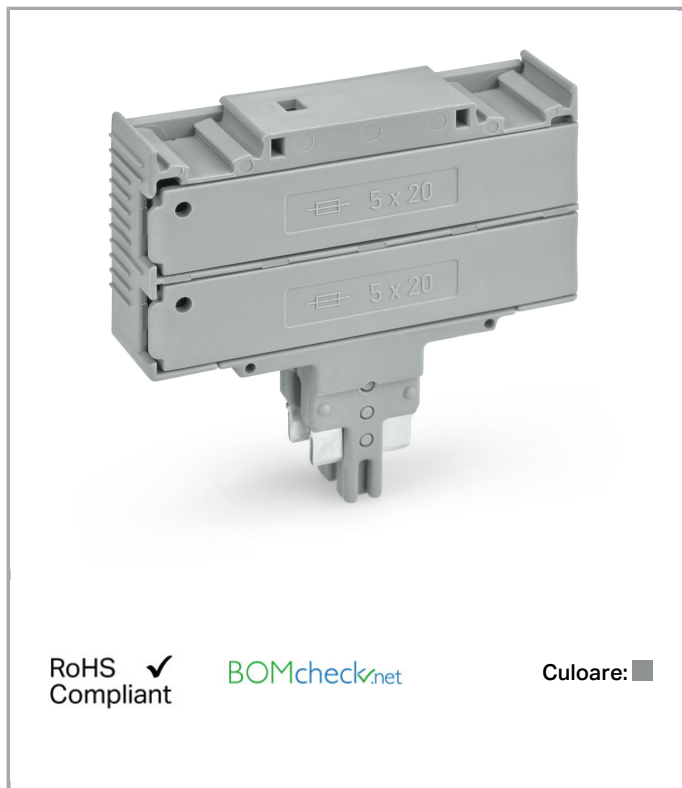

RoHS Compliant

BOMcheck.net

Culoare: ■

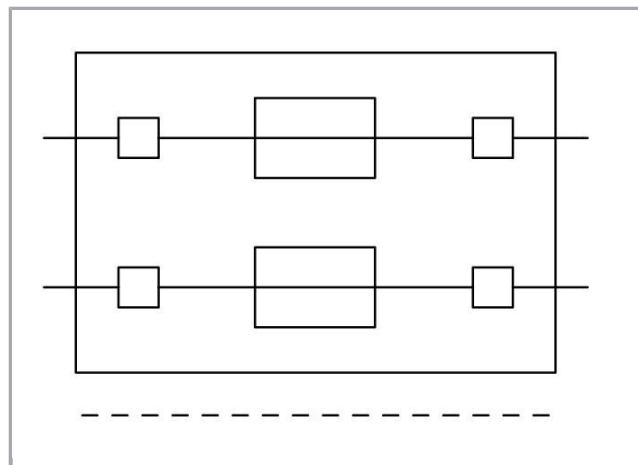

Descriere articol

Safety information 1:

Electrical ratings are given by the fuse.

Date

Electrical data

Ratings per IEC/EN 60664-1

Nominal voltage (III/3)	250 V
Rated current	6,3 A

Supus modificărilor.

WAGO Kontakttechnik GmbH & Co. KG
/Representative Office Romania
Sos. Pipera-Tunari nr. 1/1
building 1, 2nd floor | 077190 Voluntari, Ilfov
Tel.: +40-(0)31 421 85 68 | Email: info-RO@wago.com

Aveți întrebări despre produsele noastre?
Vă stăm la dispoziție pentru preluarea apelului la +40 (0) 31 421 85 68.

Approvals per UL 1059

Rated voltage UL (Use Group B)	250 V
Rated current UL (Use Group B)	6,3 A
Rated voltage UL (Use Group C)	250 V
Rated current UL (Use Group C)	6,3 A
Approvals per	UL 1059

Geometrical Data

Width	10,4 mm / 0.409 inch
-------	----------------------

Mechanical data

Marking level	Center marking
---------------	----------------

Material Data

Color	gray
Fire load	0,171 MJ
Weight	12,1 g

Commercial data

Product Group	22 (TOPJOB S)
Packaging type	BOX
Country of origin	DE
GTIN	4050821270416
Customs tariff number	85366990990

Aprobări / certificate

UL-Approvals













Emblemă	Aprobare	Text de aprobare suplimentar	Nume certificat
	UL Underwriters Laboratories Inc.	UL 1059	20190402- E45172

Supus modificărilor.

Counterpart

Produce compatibile

clamps

	Nr. articol: 2002-1661 2-conductor carrier terminal block; for DIN-rail 35 x 15 and 35 x 7.5; 2.5 mm ² ; Push-in CAGE CLAMP®; 2,50 mm ² ; gray	www.wago.com/2002-1661
	Nr. articol: 2002-1662 2-conductor carrier terminal block; for DIN-rail 35 x 15 and 35 x 7.5; 2.5 mm ² ; Push-in CAGE CLAMP®; 2,50 mm ² ; orange	www.wago.com/2002-1662
	Nr. articol: 2002-1761 3-conductor carrier terminal block; for DIN-rail 35 x 15 and 35 x 7.5; 2.5 mm ² ; Push-in CAGE CLAMP®; 2,50 mm ² ; gray	www.wago.com/2002-1761
	Nr. articol: 2002-1861 4-conductor carrier terminal block; for DIN-rail 35 x 15 and 35 x 7.5; 2.5 mm ² ; Push-in CAGE CLAMP®; 2,50 mm ² ; gray	www.wago.com/2002-1861
	Nr. articol: 2002-1961 2-conductor carrier terminal block; with additional jumper position; for DIN-rail 35 x 15 and 35 x 7.5; 2.5 mm ² ; Push-in CAGE CLAMP®; 2,50 mm ² ; gray	www.wago.com/2002-1961
	Nr. articol: 2002-2941 Double-deck, double-disconnect terminal block; L/L; for DIN-rail 35 x 15 and 35 x 7.5; 2.5 mm ² ; Push-in CAGE CLAMP®; 2,50 mm ² ; gray	www.wago.com/2002-2941
	Nr. articol: 2002-2961 Double-deck carrier terminal block; L/L; for DIN-rail 35 x 15 and 35 x 7.5; 2.5 mm ² ; Push-in CAGE CLAMP®; 2,50 mm ² ; gray	www.wago.com/2002-2961
	Nr. articol: 2002-2963 Double-deck carrier terminal block; L/N; for DIN-rail 35 x 15 and 35 x 7.5; 2.5 mm ² ; Push-in CAGE CLAMP®; 2,50 mm ² ; gray	www.wago.com/2002-2963
	Nr. articol: 2003-6640 Multilevel installation terminal block; 4 mm ² ; Carrier terminal block without knife; N/L/PE; Push-in CAGE CLAMP®; 2,50 mm ² ; gray	www.wago.com/2003-6640
	Nr. articol: 2003-6643 Multilevel installation terminal block; 4 mm ² ; Carrier terminal block without knife; P2/P1/PE; black upper deck; brown middle deck; green-yellow lower deck; Push-in CAGE CLAMP®; 2,50 mm ² ; gray	www.wago.com/2003-6643
	Nr. articol: 2003-6660 Multilevel installation terminal block; 4 mm ² ; Carrier terminal block without knife; P1/P2/PE; brown upper-deck; black middle-deck; green-yellow lower deck; Push-in CAGE CLAMP®; 2,50 mm ² ; gray	www.wago.com/2003-6660
	Nr. articol: 2202-1661 2-conductor carrier terminal block; with push-button; for DIN-rail 35 x 15 and 35 x 7.5; 2.5 mm ² ; Push-in CAGE CLAMP®; 2,50 mm ² ; gray	www.wago.com/2202-1661
	Nr. articol: 2202-1761 3-conductor carrier terminal block; with push-button; for DIN-rail 35 x 15 and 35 x 7.5; 2.5 mm ² ; Push-in CAGE CLAMP®; 2,50 mm ² ; gray	www.wago.com/2202-1761

Supus modificărilor.

**Nr. articol: 2202-1861**4-conductor carrier terminal block; with push-button; for DIN-rail 35 x 15 and 35 x 7.5; 2.5 mm²; Push-in CAGE CLAMP®; 2,50 mm²; gray www.wago.com/2202-1861**Nr. articol: 2202-1961**2-conductor carrier terminal block; with push-button; with additional jumper position; for DIN-rail 35 x 15 and 35 x 7.5; 2.5 mm²; Push-in CAGE CLAMP®; 2,50 mm²; gray www.wago.com/2202-1961**General accessories****Nr. articol: 281-503**Shorting link; 5 x 20 mm; if the fuse plug is used as disconnect plug www.wago.com/281-503**Marking accessories****Nr. articol: 2009-110**Marking strips; on reel; not stretchable; plain; snap-on type; white www.wago.com/2009-110**Nr. articol: 2009-115**WMB-Inline; for Smart Printer; 1500 pieces on roll; stretchable 5 - 5.2 mm; plain; snap-on type; white www.wago.com/2009-115**Nr. articol: 2009-115/000-002**WMB-Inline; for Smart Printer; 1500 pieces on roll; stretchable 5 - 5.2 mm; plain; snap-on type; yellow www.wago.com/2009-115/000-002**Nr. articol: 2009-115/000-006**WMB-Inline; for Smart Printer; 1500 pieces on roll; stretchable 5 - 5.2 mm; plain; snap-on type; blue www.wago.com/2009-115/000-006**Nr. articol: 2009-115/000-007**WMB-Inline; for Smart Printer; 1500 pieces on roll; stretchable 5 - 5.2 mm; plain; snap-on type; gray www.wago.com/2009-115/000-007**Nr. articol: 2009-115/000-012**WMB-Inline; for Smart Printer; 1500 pieces on roll; stretchable 5 - 5.2 mm; plain; snap-on type; orange www.wago.com/2009-115/000-012**Nr. articol: 2009-115/000-017**WMB-Inline; for Smart Printer; 1500 pieces on roll; stretchable 5 - 5.2 mm; plain; snap-on type; light green www.wago.com/2009-115/000-017**Nr. articol: 2009-115/000-023**WMB-Inline; for Smart Printer; 1500 pieces on roll; stretchable 5 - 5.2 mm; plain; snap-on type; green www.wago.com/2009-115/000-023**Nr. articol: 2009-115/000-024**WMB-Inline; for Smart Printer; 1500 pieces on roll; stretchable 5 - 5.2 mm; plain; snap-on type; violet www.wago.com/2009-115/000-024**Nr. articol: 793-501**WMB marking card; as card; not stretchable; plain; snap-on type; white www.wago.com/793-501**Nr. articol: 793-501/000-002**WMB marking card; as card; not stretchable; plain; snap-on type; yellow www.wago.com/793-501/000-002

Supus modificărilor.

WAGO Kontakttechnik GmbH & Co. KG
 /Representative Office Romania
 Sos. Pipera-Tunari nr. 1/1
 building 1, 2nd floor | 077190 Voluntari, Ilfov
 Tel.: +40-(0)31 421 85 68 | Email: info-RO@wago.com

Aveți întrebări despre produsele noastre?
 Vă stăm la dispoziție pentru preluarea apelului la +40 (0) 31 421 85 68.



Nr. articol: 793-501/000-005
WMB marking card; as card; not stretchable; plain; snap-on type; red

www.wago.com/793-501/000-005



Nr. articol: 793-501/000-006
WMB marking card; as card; not stretchable; plain; snap-on type; blue

www.wago.com/793-501/000-006



Nr. articol: 793-501/000-007
WMB marking card; as card; not stretchable; plain; snap-on type; gray

www.wago.com/793-501/000-007



Nr. articol: 793-501/000-012
WMB marking card; as card; not stretchable; plain; snap-on type; orange

www.wago.com/793-501/000-012



Nr. articol: 793-501/000-017
WMB marking card; as card; not stretchable; plain; snap-on type; light green

www.wago.com/793-501/000-017



Nr. articol: 793-501/000-023
WMB marking card; as card; not stretchable; plain; snap-on type; green

www.wago.com/793-501/000-023



Nr. articol: 793-501/000-024
WMB marking card; as card; not stretchable; plain; snap-on type; violet

www.wago.com/793-501/000-024



Nr. articol: 793-5501
WMB marking card; as card; for terminal block width 5 - 17.5 mm; stretchable 5 - 5.2 mm; plain; snap-on type; white

www.wago.com/793-5501



Nr. articol: 793-5501/000-002
WMB marking card; as card; for terminal block width 5 - 17.5 mm; stretchable 5 - 5.2 mm; plain; snap-on type; yellow

www.wago.com/793-5501/000-002



Nr. articol: 793-5501/000-005
WMB marking card; as card; for terminal block width 5 - 17.5 mm; stretchable 5 - 5.2 mm; plain; snap-on type; red

www.wago.com/793-5501/000-005



Nr. articol: 793-5501/000-006
WMB marking card; as card; for terminal block width 5 - 17.5 mm; stretchable 5 - 5.2 mm; plain; snap-on type; blue

www.wago.com/793-5501/000-006



Nr. articol: 793-5501/000-007
WMB marking card; as card; for terminal block width 5 - 17.5 mm; stretchable 5 - 5.2 mm; plain; snap-on type; gray

www.wago.com/793-5501/000-007



Nr. articol: 793-5501/000-012
WMB marking card; as card; for terminal block width 5 - 17.5 mm; stretchable 5 - 5.2 mm; plain; snap-on type; orange

www.wago.com/793-5501/000-012



Nr. articol: 793-5501/000-014
WMB marking card; as card; for terminal block width 5 - 17.5 mm; stretchable 5 - 5.2 mm; plain; snap-on type

www.wago.com/793-5501/000-014

Supus modificărilor.

type; brown

**Nr. articol: 793-5501/000-017**

WMB marking card; as card; for terminal block width 5 - 17.5 mm; stretchable 5 - 5.2 mm; plain; snap-on type; green

www.wago.com/793-5501/000-017**Nr. articol: 793-5501/000-023**

WMB marking card; as card; for terminal block width 5 - 17.5 mm; stretchable 5 - 5.2 mm; plain; snap-on type; light green

www.wago.com/793-5501/000-023**Nr. articol: 793-5501/000-024**

WMB marking card; as card; for terminal block width 5 - 17.5 mm; stretchable 5 - 5.2 mm; plain; snap-on type; violet

www.wago.com/793-5501/000-024

Descărcări

Documentation

Additional Information

Technical explanations

Apr 3, 2019

pdf
2,1 MB

Descărcare

Installation Notes

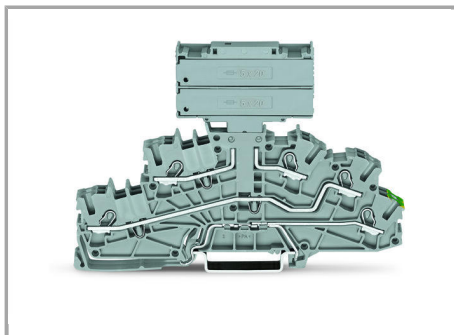

Double-fuse plugs with (5 x 25) mm miniature metric fuses can be used on carrier terminal blocks without N-knife disconnect in standard terminal block width.

Familie de produse

TOPJOB® S

TOPJOB® S: In various industrial applications and modern building installations, WAGO's wide and versatile range of rail-mount terminal blocks provides more than just reliable electrical connections.

[Afișare globală produse din familie.](#)

Supus modificărilor.

WAGO Kontakttechnik GmbH & Co. KG
/Representative Office Romania
Sos. Pipera-Tunari nr. 1/1
building 1, 2nd floor | 077190 Voluntari, Ilfov
Tel.: +40-(0)31 421 85 68 | Email: info-RO@wago.com

Aveți întrebări despre produsele noastre?

Vă stăm la dispoziție pentru preluarea apelului la +40 (0) 31 421 85 68.