

# Fișă tehnică | Număr articol: 831-303

Snap-in frame; 1 part; Pin spacing 7.62 mm; 3-pole; light gray

[www.wago.com/831-303](http://www.wago.com/831-303)

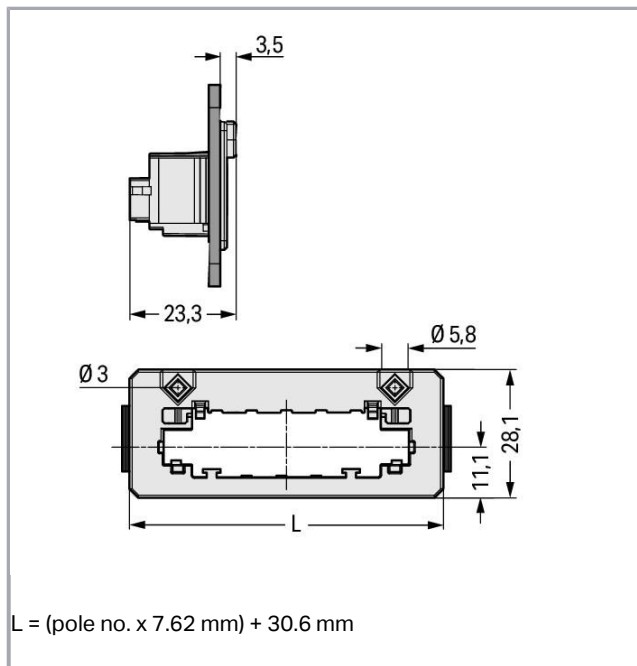
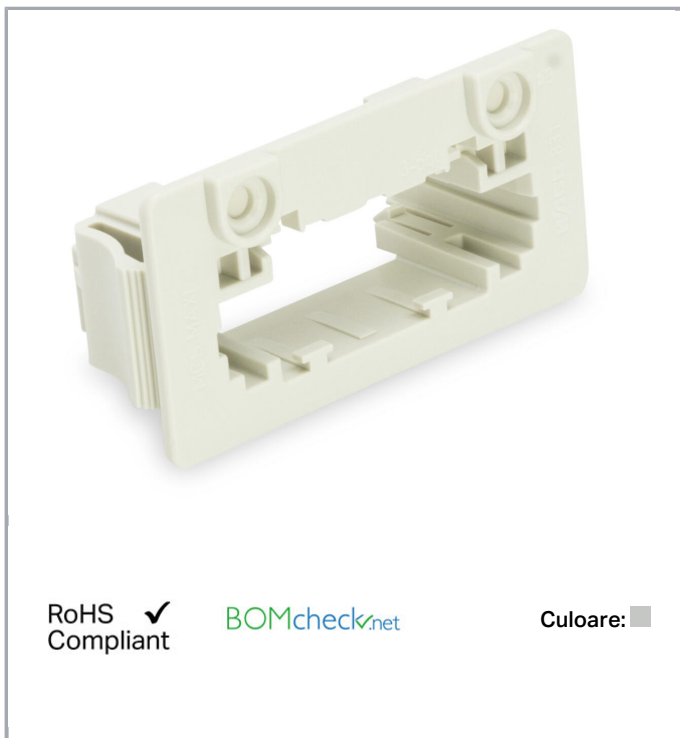

Supus modificărilor.

WAGO Kontakttechnik GmbH & Co. KG  
/Representative Office Romania  
Sos. Pipera-Tunari nr. 1/1  
building 1, 2nd floor | 077190 Voluntari, Ilfov  
Tel.: +40-(0)31 421 85 68 | Email: [info-RO@wago.com](mailto:info-RO@wago.com)

Aveți întrebări despre produsele noastre?  
Vă stăm la dispoziție pentru preluarea apelului la +40 (0) 31 421 85 68.

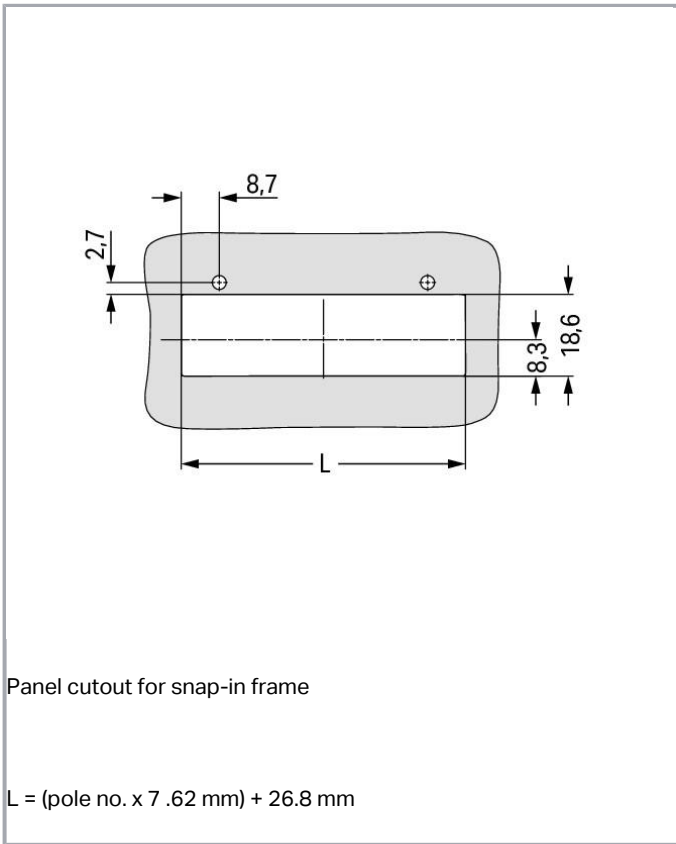

## Descriere articol

- Snap-in frames for through-panel MCS MAXI connectors
- Fast and easy installation – without tools
- Compatible with MCS MAXI male and female connectors
- For panel thickness ranging from 0.5 to 2.5 mm
- Optional screw mounting

## Date

### Electrical data

### Ratings per IEC/EN 60664-1

Legend (ratings)

(III / 2) ≙ Overvoltage category III / Pollution degree 2

### Approvals per UL 1059

Approvals per

UL 1059

Supus modificărilor.

WAGO Kontakttechnik GmbH & Co. KG  
/Representative Office Romania  
Sos. Pipera-Tunari nr. 1/1  
building 1, 2nd floor | 077190 Voluntari, Ilfov  
Tel.: +40-(0)31 421 85 68 | Email: info-RO@wago.com

Aveți întrebări despre produsele noastre?  
Vă stăm la dispoziție pentru preluarea apelului la +40 (0) 31 421 85 68.



## Connection data

Number of connection types	1
----------------------------	---

## Geometrical Data

Width	53.46 mm / 2.105 inch
Height	28.1 mm / 1.106 inch
Depth	23.3 mm / 0.917 inch

## Mechanical data

Mounting type	Snap-in
Mounting type	Feed-through mounting

## Material Data

Color	light gray
Weight	6,1 g

## Commercial data

Packaging type	BOX
Country of origin	DE
GTIN	4055143564854
Customs tariff number	39269097900

## Counterpart

## Descărcări

### Documentation

#### Additional Information

Technical explanations	Apr 3, 2019	pdf 3,6 MB	Descărcare
------------------------	-------------	---------------	------------

## CAD/CAE-Data

### CAD data

2D/3D Models 831-303	URL	Descărcare
----------------------	-----	------------

Supus modificărilor.

## Installation Notes

### Assembly

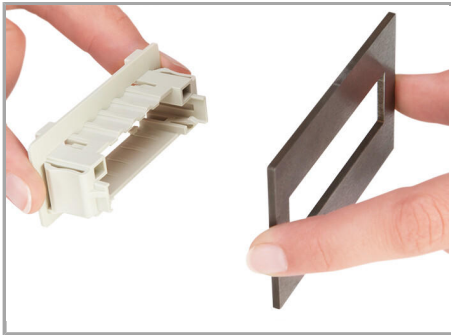

Insert the snap-in frame into the cutout.

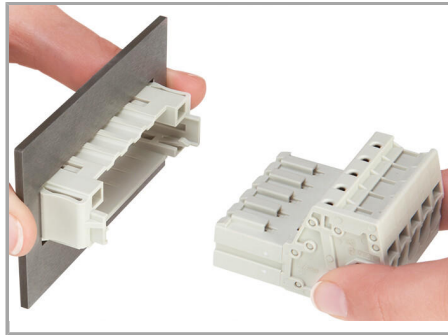

Insert the male connector into the snap-in frame.

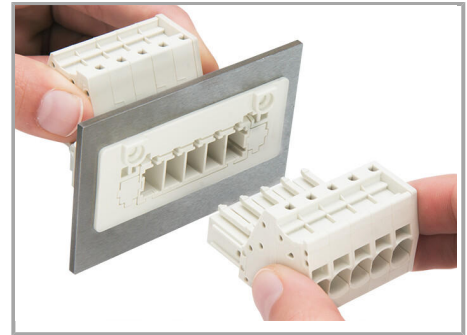

Inserting a female connector without lateral locking levers - lockout pins are inserted on both sides of the snap-in frame.

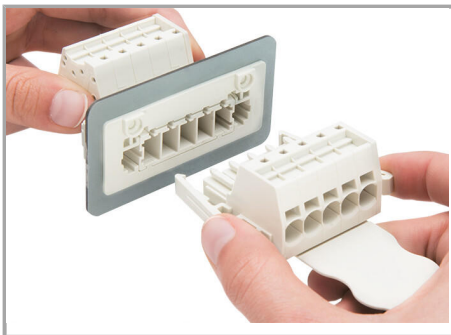

Inserting a female connector equipped with lateral locking levers.

Supus modificărilor.