

Fișă tehnică | Număr articol: 769-645/004-000

THT male header; 1.0 x 1.0 mm solder pin; straight; Pin spacing 5 mm; 15-pole; gray



www.wago.com/769-645/004-000



RoHS Compliant

BOMcheck.net

Culoare: ■

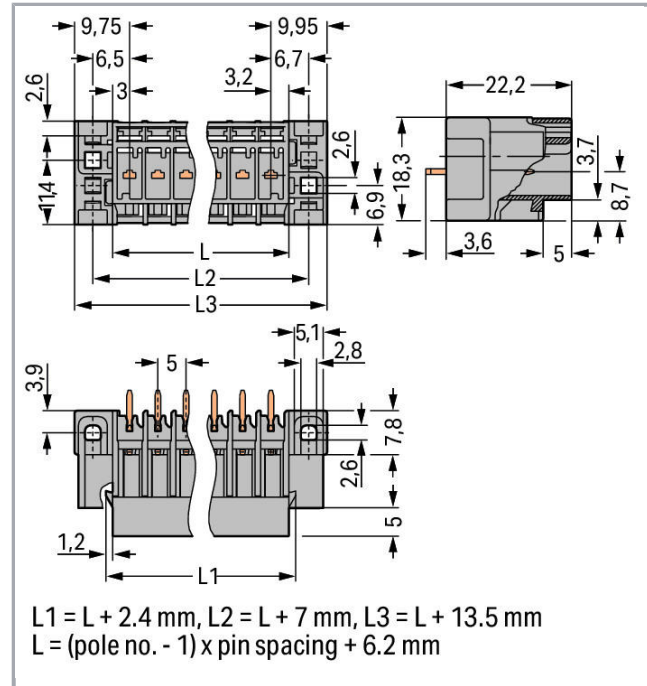

Date

Electrical data

Ratings per IEC/EN 60664-1

Nominal voltage (III/3)	250 V
Rated surge voltage (III/3)	4 kV
Rated voltage (III/2)	500 V
Rated surge voltage (III/2)	4 kV
Rated current	32 A
Legend (ratings)	(III / 3) ≙ Overvoltage category III / Pollution degree 3

Supus modificărilor.

WAGO Kontakttechnik GmbH & Co. KG
/Representative Office Romania
Sos. Pipera-Tunari nr. 1/1
building 1, 2nd floor | 077190 Voluntari, Ilfov
Tel.: +40-(0)31 421 85 68 | Email: info-RO@wago.com

Aveți întrebări despre produsele noastre?
Vă stăm la dispoziție pentru preluarea apelului la +40 (0) 31 421 85 68.

**Connection data**

Pole No.	15
Total number of potentials	15
Number of levels	1

Geometrical Data

Pin spacing	5 mm / 0.197 inch
Width	89,7 mm / 3.531 inch
Height from the surface	22,2 mm / 0.874 inch
Depth	18,3 mm / 0.72 inch

Mechanical data

Mounting type	Mounting flange
---------------	-----------------

Plug connection

Contact type (pluggable connector)	Male connector/plug
Connector (connection type)	for PCB
Mismating protection	No
Mating direction to the PCB	90°

PCB contact

PCB contact	THT
-------------	-----

Material Data

Color	gray
Insulation material	Polyamide 66 (PA 66)
Fire load	0,343 MJ
Weight	15,9 g

Commercial data

Product Group	18 (X-COM-System)
Packaging type	BOX
Country of origin	PL
GTIN	4017332412858

Supus modificărilor.





WAGO Kontakttechnik GmbH & Co. KG
 /Representative Office Romania
 Sos. Pipera-Tunari nr. 1/1
 building 1, 2nd floor | 077190 Voluntari, Ilfov
 Tel.: +40-(0)31 421 85 68 | Email: info-RO@wago.com

Aveți întrebări despre produsele noastre?
 Vă stăm la dispoziție pentru preluarea apelului la +40 (0) 31 421 85 68.

Customs tariff number

85366990990



Aprobări / certificate**Country specific Approvals**

Emblemă	Aprobare	Text de aprobare suplimentar	Nume certificat
	CCA DEKRA Certification B.V.	EN 60947	NTR NL-7626
	CCA DEKRA Certification B.V.	EN 61984	2190419.02
	CSA DEKRA Certification B.V.	C22.2 No. 158	1101144
	KEMA/KEUR DEKRA Certification B.V.	EN 60947	2190419.01

Ship Approvals

Emblemă	Aprobare	Text de aprobare suplimentar	Nume certificat
	DNV GL Det Norske Veritas, Germanischer Lloyd	-	TAE00001V2

UL-Approvals

Emblemă	Aprobare	Text de aprobare suplimentar	Nume certificat
	UR Underwriters Laboratories Inc.	UL 1977	20151210-E45171
	UR Underwriters Laboratories Inc.	UL 1059	20190731-E45172

Supus modificărilor.

WAGO Kontakttechnik GmbH & Co. KG
/Representative Office Romania
Sos. Pipera-Tunari nr. 1/1
building 1, 2nd floor | 077190 Voluntari, Ilfov
Tel.: +40-(0)31 421 85 68 | Email: info-RO@wago.com

Aveți întrebări despre produsele noastre?
Vă stăm la dispoziție pentru preluarea apelului la +40 (0) 31 421 85 68.

Counterpart

Produse compatibile

Coding

**Nr. articol: 769-435**















Coding pin; for coding of female plugs; for carrier terminal blocks / male connectors; orange

www.wago.com/769-435















Female plug

**Nr. articol: 769-101**1-conductor female plug; 4 mm²; 1-pole; 4,00 mm²; graywww.wago.com/769-101**Nr. articol: 769-102**1-conductor female plug; 4 mm²; 2-pole; 4,00 mm²; graywww.wago.com/769-102**Nr. articol: 769-102/000-036**1-conductor female plug; 4 mm²; 2-pole; 4,00 mm²; gray, green-yellowwww.wago.com/769-102/000-036**Nr. articol: 769-102/000-037**1-conductor female plug; 4 mm²; 2-pole; 4,00 mm²; green-yellow, graywww.wago.com/769-102/000-037**Nr. articol: 769-103**1-conductor female plug; 4 mm²; 3-pole; 4,00 mm²; graywww.wago.com/769-103**Nr. articol: 769-103/000-036**1-conductor female plug; 4 mm²; 3-pole; 4,00 mm²; gray, green-yellowwww.wago.com/769-103/000-036**Nr. articol: 769-103/000-037**1-conductor female plug; 4 mm²; 3-pole; 4,00 mm²; green-yellow, graywww.wago.com/769-103/000-037**Nr. articol: 769-103/000-038**1-conductor female plug; 4 mm²; 3-pole; 4,00 mm²; gray, blue, green-yellowwww.wago.com/769-103/000-038**Nr. articol: 769-103/000-039**1-conductor female plug; 4 mm²; 3-pole; 4,00 mm²; green-yellow, blue, graywww.wago.com/769-103/000-039**Nr. articol: 769-104**1-conductor female plug; 4 mm²; 4-pole; 4,00 mm²; graywww.wago.com/769-104**Nr. articol: 769-104/000-036**1-conductor female plug; 4 mm²; 4-pole; 4,00 mm²; gray, green-yellowwww.wago.com/769-104/000-036

Supus modificărilor.

	Nr. articol: 769-104/000-037 1-conductor female plug; 4 mm ² ; 4-pole; 4,00 mm ² ; green-yellow, gray	www.wago.com/769-104/000-037
	Nr. articol: 769-104/000-038 1-conductor female plug; 4 mm ² ; 4-pole; 4,00 mm ² ; gray, blue, green-yellow	www.wago.com/769-104/000-038
	Nr. articol: 769-104/000-039 1-conductor female plug; 4 mm ² ; 4-pole; 4,00 mm ² ; green-yellow, blue, gray	www.wago.com/769-104/000-039
	Nr. articol: 769-105 1-conductor female plug; 4 mm ² ; 5-pole; 4,00 mm ² ; gray	www.wago.com/769-105
	Nr. articol: 769-105/000-036 1-conductor female plug; 4 mm ² ; 5-pole; 4,00 mm ² ; gray, green-yellow	www.wago.com/769-105/000-036
	Nr. articol: 769-105/000-037 1-conductor female plug; 4 mm ² ; 5-pole; 4,00 mm ² ; green-yellow, gray	www.wago.com/769-105/000-037
	Nr. articol: 769-105/000-038 1-conductor female plug; 4 mm ² ; 5-pole; 4,00 mm ² ; gray, blue, green-yellow	www.wago.com/769-105/000-038
	Nr. articol: 769-105/000-039 1-conductor female plug; 4 mm ² ; 5-pole; 4,00 mm ² ; green-yellow, blue, gray	www.wago.com/769-105/000-039
	Nr. articol: 769-106 1-conductor female plug; 4 mm ² ; 6-pole; 4,00 mm ² ; gray	www.wago.com/769-106
	Nr. articol: 769-106/000-006 1-conductor female plug; 4 mm ² ; 6-pole; 4,00 mm ² ; blue	www.wago.com/769-106/000-006
	Nr. articol: 769-106/000-036 1-conductor female plug; 4 mm ² ; 6-pole; 4,00 mm ² ; gray, green-yellow	www.wago.com/769-106/000-036
	Nr. articol: 769-106/000-037 1-conductor female plug; 4 mm ² ; 6-pole; 4,00 mm ² ; green-yellow, gray	www.wago.com/769-106/000-037
	Nr. articol: 769-106/000-038 1-conductor female plug; 4 mm ² ; 6-pole; 4,00 mm ² ; gray, blue, green-yellow	www.wago.com/769-106/000-038
	Nr. articol: 769-106/000-039 1-conductor female plug; 4 mm ² ; 6-pole; 4,00 mm ² ; green-yellow, blue, gray	www.wago.com/769-106/000-039

Supus modificărilor.

	Nr. articol: 769-107 1-conductor female plug; 4 mm ² ; 7-pole; 4,00 mm ² ; gray	www.wago.com/769-107
	Nr. articol: 769-107/000-036 1-conductor female plug; 4 mm ² ; 7-pole; 4,00 mm ² ; gray, green-yellow	www.wago.com/769-107/000-036
	Nr. articol: 769-107/000-037 1-conductor female plug; 4 mm ² ; 7-pole; 4,00 mm ² ; green-yellow, gray	www.wago.com/769-107/000-037
	Nr. articol: 769-107/000-038 1-conductor female plug; 4 mm ² ; 7-pole; 4,00 mm ² ; gray, blue, green-yellow	www.wago.com/769-107/000-038
	Nr. articol: 769-107/000-039 1-conductor female plug; 4 mm ² ; 7-pole; 4,00 mm ² ; green-yellow, blue, gray	www.wago.com/769-107/000-039
	Nr. articol: 769-108 1-conductor female plug; 4 mm ² ; 8-pole; 4,00 mm ² ; gray	www.wago.com/769-108
	Nr. articol: 769-108/000-036 1-conductor female plug; 4 mm ² ; 8-pole; 4,00 mm ² ; gray, green-yellow	www.wago.com/769-108/000-036
	Nr. articol: 769-108/000-037 1-conductor female plug; 4 mm ² ; 8-pole; 4,00 mm ² ; green-yellow, gray	www.wago.com/769-108/000-037
	Nr. articol: 769-108/000-038 1-conductor female plug; 4 mm ² ; 8-pole; 4,00 mm ² ; gray, blue, green-yellow	www.wago.com/769-108/000-038
	Nr. articol: 769-108/000-039 1-conductor female plug; 4 mm ² ; 8-pole; 4,00 mm ² ; green-yellow, blue, gray	www.wago.com/769-108/000-039
	Nr. articol: 769-109 1-conductor female plug; 4 mm ² ; 9-pole; 4,00 mm ² ; gray	www.wago.com/769-109
	Nr. articol: 769-109/000-036 1-conductor female plug; 4 mm ² ; 9-pole; 4,00 mm ² ; gray, green-yellow	www.wago.com/769-109/000-036
	Nr. articol: 769-109/000-037 1-conductor female plug; 4 mm ² ; 9-pole; 4,00 mm ² ; green-yellow, gray	www.wago.com/769-109/000-037
	Nr. articol: 769-109/000-038 1-conductor female plug; 4 mm ² ; 9-pole; 4,00 mm ² ; gray, blue, green-yellow	www.wago.com/769-109/000-038

Supus modificărilor.

WAGO Kontakttechnik GmbH & Co. KG
 /Representative Office Romania
 Sos. Pipera-Tunari nr. 1/1
 building 1, 2nd floor | 077190 Voluntari, Ilfov
 Tel.: +40-(0)31 421 85 68 | Email: info-RO@wago.com

Aveți întrebări despre produsele noastre?
 Vă stăm la dispoziție pentru preluarea apelului la +40 (0) 31 421 85 68.



Nr. articol: 769-109/000-039

1-conductor female plug; 4 mm²; 9-pole; 4,00 mm²; green-yellow, blue, gray

www.wago.com/769-109/000-039



Nr. articol: 769-110

1-conductor female plug; 4 mm²; 10-pole; 4,00 mm²; gray

www.wago.com/769-110



Nr. articol: 769-110/000-036

1-conductor female plug; 4 mm²; 10-pole; 4,00 mm²; gray, green-yellow

www.wago.com/769-110/000-036



Nr. articol: 769-110/000-037

1-conductor female plug; 4 mm²; 10-pole; 4,00 mm²; green-yellow, gray

www.wago.com/769-110/000-037



Nr. articol: 769-110/000-038

1-conductor female plug; 4 mm²; 10-pole; 4,00 mm²; gray, blue, green-yellow

www.wago.com/769-110/000-038



Nr. articol: 769-110/000-039

1-conductor female plug; 4 mm²; 10-pole; 4,00 mm²; green-yellow, blue, gray

www.wago.com/769-110/000-039



Nr. articol: 769-111

1-conductor female plug; 4 mm²; 11-pole; 4,00 mm²; gray

www.wago.com/769-111



Nr. articol: 769-111/000-036

1-conductor female plug; 4 mm²; 11-pole; 4,00 mm²; gray, green-yellow

www.wago.com/769-111/000-036



Nr. articol: 769-111/000-037

1-conductor female plug; 4 mm²; 11-pole; 4,00 mm²; green-yellow, gray

www.wago.com/769-111/000-037



Nr. articol: 769-111/000-038

1-conductor female plug; 4 mm²; 11-pole; 4,00 mm²; gray, blue, green-yellow

www.wago.com/769-111/000-038



Nr. articol: 769-111/000-039

1-conductor female plug; 4 mm²; 11-pole; 4,00 mm²; green-yellow, blue, gray

www.wago.com/769-111/000-039



Nr. articol: 769-112

1-conductor female plug; 4 mm²; 12-pole; 4,00 mm²; gray

www.wago.com/769-112



Nr. articol: 769-112/000-036

1-conductor female plug; 4 mm²; 12-pole; 4,00 mm²; gray, green-yellow

www.wago.com/769-112/000-036



Nr. articol: 769-112/000-037

1-conductor female plug; 4 mm²; 12-pole; 4,00 mm²; green-yellow, gray

www.wago.com/769-112/000-037

Supus modificărilor.



Nr. articol: 769-112/000-038

1-conductor female plug; 4 mm²; 12-pole; 4,00 mm²; gray, blue, green-yellow

www.wago.com/769-112/000-038



Nr. articol: 769-112/000-039

1-conductor female plug; 4 mm²; 12-pole; 4,00 mm²; green-yellow, blue, gray

www.wago.com/769-112/000-039



Nr. articol: 769-113

1-conductor female plug; 4 mm²; 13-pole; 4,00 mm²; gray

www.wago.com/769-113



Nr. articol: 769-113/000-036

1-conductor female plug; 4 mm²; 13-pole; 4,00 mm²; gray, green-yellow

www.wago.com/769-113/000-036



Nr. articol: 769-113/000-037

1-conductor female plug; 4 mm²; 13-pole; 4,00 mm²; green-yellow, gray

www.wago.com/769-113/000-037



Nr. articol: 769-113/000-038

1-conductor female plug; 4 mm²; 13-pole; 4,00 mm²; gray, blue, green-yellow

www.wago.com/769-113/000-038



Nr. articol: 769-113/000-039

1-conductor female plug; 4 mm²; 13-pole; 4,00 mm²; green-yellow, blue, gray

www.wago.com/769-113/000-039



Nr. articol: 769-114

1-conductor female plug; 4 mm²; 14-pole; 4,00 mm²; gray

www.wago.com/769-114



Nr. articol: 769-114/000-036

1-conductor female plug; 4 mm²; 14-pole; 4,00 mm²; gray, green-yellow

www.wago.com/769-114/000-036



Nr. articol: 769-114/000-037

1-conductor female plug; 4 mm²; 14-pole; 4,00 mm²; green-yellow, gray

www.wago.com/769-114/000-037



Nr. articol: 769-114/000-038

1-conductor female plug; 4 mm²; 14-pole; 4,00 mm²; gray, blue, green-yellow

www.wago.com/769-114/000-038



Nr. articol: 769-114/000-039

1-conductor female plug; 4 mm²; 14-pole; 4,00 mm²; green-yellow, blue, gray

www.wago.com/769-114/000-039



Nr. articol: 769-115

1-conductor female plug; 4 mm²; 15-pole; 4,00 mm²; gray

www.wago.com/769-115



Nr. articol: 769-115/000-036

1-conductor female plug; 4 mm²; 15-pole; 4,00 mm²; gray, green-yellow

www.wago.com/769-115/000-036

Supus modificărilor.



Nr. articol: 769-115/000-037

1-conductor female plug; 4 mm²; 15-pole; 4,00 mm²; green-yellow, gray

www.wago.com/769-115/000-037



Nr. articol: 769-115/000-038

1-conductor female plug; 4 mm²; 15-pole; 4,00 mm²; gray, blue, green-yellow

www.wago.com/769-115/000-038



Nr. articol: 769-115/000-039

1-conductor female plug; 4 mm²; 15-pole; 4,00 mm²; green-yellow, blue, gray

www.wago.com/769-115/000-039



Nr. articol: 769-115/021-000

1-conductor female plug; Locking lever; 4 mm²; 15-pole; 4,00 mm²; gray

www.wago.com/769-115/021-000



Nr. articol: 769-121

2-conductor female connector; 4 mm²; 1-pole; 4,00 mm²; gray

www.wago.com/769-121



Nr. articol: 769-122

2-conductor female connector; 4 mm²; 2-pole; 4,00 mm²; gray

www.wago.com/769-122



Nr. articol: 769-123

2-conductor female connector; 4 mm²; 3-pole; 4,00 mm²; gray

www.wago.com/769-123



Nr. articol: 769-124

2-conductor female connector; 4 mm²; 4-pole; 4,00 mm²; gray

www.wago.com/769-124



Nr. articol: 769-125

2-conductor female connector; 4 mm²; 5-pole; 4,00 mm²; gray

www.wago.com/769-125



Nr. articol: 769-126

2-conductor female connector; 4 mm²; 6-pole; 4,00 mm²; gray

www.wago.com/769-126



Nr. articol: 769-127

2-conductor female connector; 4 mm²; 7-pole; 4,00 mm²; gray

www.wago.com/769-127



Nr. articol: 769-128

2-conductor female connector; 4 mm²; 8-pole; 4,00 mm²; gray

www.wago.com/769-128



Nr. articol: 769-129

2-conductor female connector; 4 mm²; 9-pole; 4,00 mm²; gray

www.wago.com/769-129



Nr. articol: 769-130

2-conductor female connector; 4 mm²; 10-pole; 4,00 mm²; gray

www.wago.com/769-130



Nr. articol: 769-131

2-conductor female connector; 4 mm²; 11-pole; 4,00 mm²; gray

www.wago.com/769-131



Nr. articol: 769-132

2-conductor female connector; 4 mm²; 12-pole; 4,00 mm²; gray

www.wago.com/769-132



Nr. articol: 769-133

2-conductor female connector; 4 mm²; 13-pole; 4,00 mm²; gray

www.wago.com/769-133

Supus modificărilor.

**Nr. articol: 769-134**2-conductor female connector; 4 mm²; 14-pole; 4,00 mm²; graywww.wago.com/769-134**Nr. articol: 769-135**2-conductor female connector; 4 mm²; 15-pole; 4,00 mm²; graywww.wago.com/769-135**Marking accessories****Nr. articol: 210-831**

Marking strips; on reel; 2.3 mm wide; plain; Self-adhesive; white

www.wago.com/210-831**Nr. articol: 210-832**

Marking strips; on reel; 3 mm wide; plain; Self-adhesive; white

www.wago.com/210-832**Nr. articol: 210-833**

Marking strips; on reel; 6 mm wide; plain; Self-adhesive; white

www.wago.com/210-833**Nr. articol: 210-834**

Marking strips; on reel; 5 mm wide; plain; Self-adhesive; white

www.wago.com/210-834**Descărcări****Documentation****Additional Information**

Technical explanations

Apr 3, 2019

pdf
2,1 MB

Descărcare

CAD/CAE-Data**CAD data**

2D/3D Models 769-645/004-000

URL

Descărcare

PCB Design

Symbol and Footprint 769-645/004-000

URL

Descărcare

CAX data for your PCB design, consisting of "schematic symbols and PCB footprints", allow easy integration of the WAGO component into your development environment.

Supported formats:

- Accel EDA 14 & 15
- Altium 6 to current version
- Cadence Allegro
- DesignSpark
- Eagle Libraries
- KiCad

Supus modificărilor.

WAGO Kontakttechnik GmbH & Co. KG
/Representative Office Romania
Sos. Pipera-Tunari nr. 1/1
building 1, 2nd floor | 077190 Voluntari, Ilfov
Tel.: +40-(0)31 421 85 68 | Email: info-RO@wago.com

Aveți întrebări despre produsele noastre?

Vă stăm la dispoziție pentru preluarea apelului la +40 (0) 31 421 85 68.

- Mentor Graphics BoardStation
- Mentor Graphics Design Architect
- Mentor Graphics Design Expedition 99 and 2000
- OrCAD 9.X PCB and Capture
- PADS PowerPCB 3, 3.5, 4.X, and 5.X
- PADS PowerPCB and PowerLogic 3.0
- PCAD 2000, 2001, 2002, 2004, and 2006
- Pulsonix 8.5 or newer
- STL
- 3D STEP
- TARGET 3001!
- View Logic ViewDraw
- Quadcept
- Zuken CadStar 3 and 4
- Zuken CR-5000 and CR-8000

PCB Component Libraries (EDA), PCB CAD Library Ultra Librarian

Installation Notes

Assembly

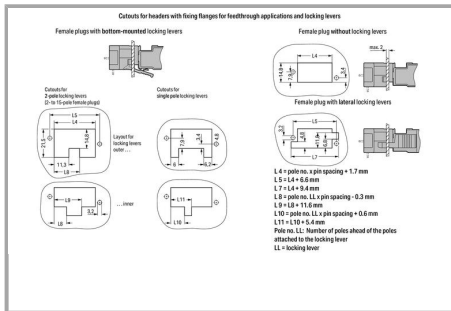

Cutouts for headers with fixing flanges for feedthrough applications and locking levers

Application

Supus modificărilor.

WAGO Kontakttechnik GmbH & Co. KG
 /Representative Office Romania
 Sos. Pipera-Tunari nr. 1/1
 building 1, 2nd floor | 077190 Voluntari, Ilfov
 Tel.: +40-(0)31 421 85 68 | Email: info-RO@wago.com

Aveți întrebări despre produsele noastre?
 Vă stăm la dispoziție pentru preluarea apelului la +40 (0) 31 421 85 68.

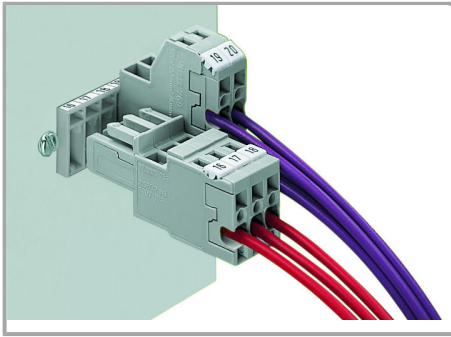

Male header with straight or angled solder pins and feedthrough flanges

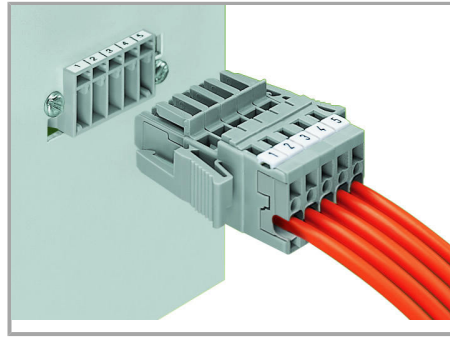

Male header and 1-conductor female plug with lateral locking levers

1-conductor female plug

2-conductor female plug

Familie de produse

X-COM

[Afișare globală produse din familie.](#)

Supus modificărilor.