

Fișă tehnică | Număr articol: 2003-911/1000-923

Double fuse plug; for 5 x 20 mm miniature metric fuse; with indicator lamp;
230 V; 10.4 mm wide; gray

www.wago.com/2003-911/1000-923

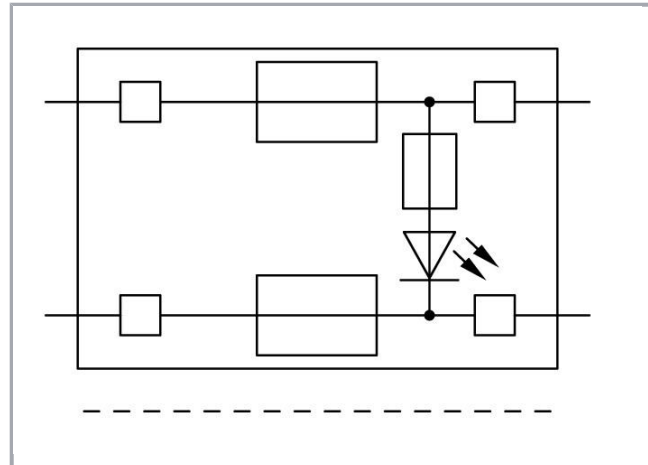
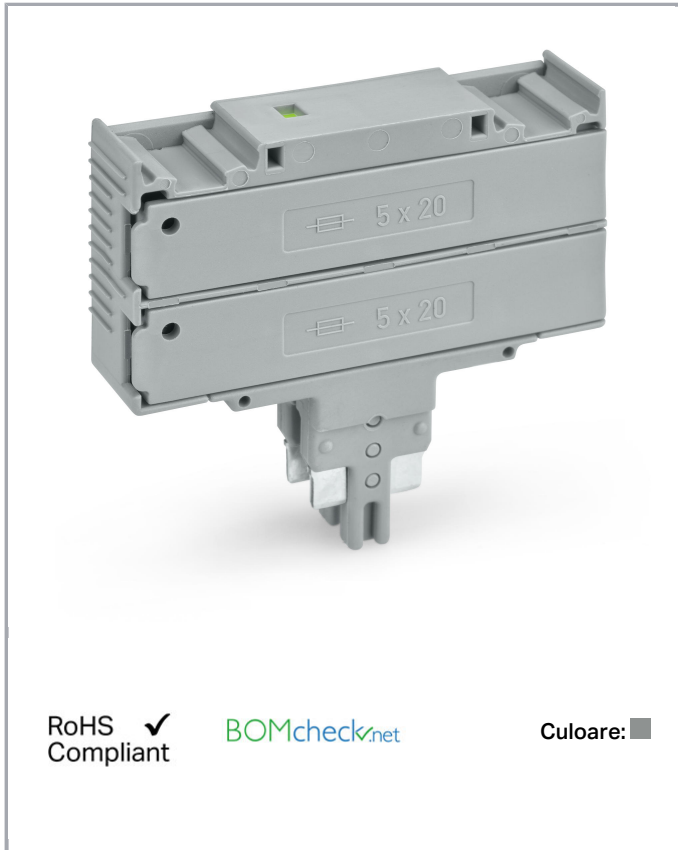

Descriere articol

Safety information 1:

Electrical ratings are given by the fuse and blown fuse indication.

Safety information 2:

LED 0.25 mA

Date

Electrical data

Ratings per IEC/EN 60664-1

| | |
|-------------------------|-------|
| Nominal voltage (III/3) | 250 V |
| Rated current | 6,3 A |

Supus modificărilor.

WAGO Kontakttechnik GmbH & Co. KG
/Representative Office Romania
Sos. Pipera-Tunari nr. 1/1
building 1, 2nd floor | 077190 Voluntari, Ilfov
Tel.: +40-(0)31 421 85 68 | Email: info-RO@wago.com

Aveți întrebări despre produsele noastre?

Vă stăm la dispoziție pentru preluarea apelului la +40 (0) 31 421 85 68.

| | |
|----------------------------|-------|
| Operation status indicator | 230 V |
|----------------------------|-------|

Approvals per UL 1059

| | |
|--------------------------------|---------|
| Rated voltage UL (Use Group B) | 250 V |
| Rated current UL (Use Group B) | 6,3 A |
| Rated voltage UL (Use Group C) | 250 V |
| Rated current UL (Use Group C) | 6,3 A |
| Approvals per | UL 1059 |

Geometrical Data

| | |
|-------|----------------------|
| Width | 10,4 mm / 0.409 inch |
|-------|----------------------|

Mechanical data

| | |
|---------------|----------------|
| Marking level | Center marking |
|---------------|----------------|

Material Data

| | |
|--------|-------|
| Color | gray |
| Weight | 12,8g |

Commercial data

| | |
|-----------------------|---------------|
| Packaging type | BOX |
| Country of origin | DE |
| GTIN | 4050821608134 |
| Customs tariff number | 85366990990 |

Aprobări / certificate

UL-Approvals

| Emblemă | Aprobare | Text de aprobare suplimentar | Nume certificat |
|--|--------------------------------------|------------------------------|---------------------|
|  | UL Underwriters Laboratories Inc. | UL 1059 | 20190402- E45172 |

Counterpart









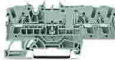

Supus modificărilor.

WAGO Kontakttechnik GmbH & Co. KG
/Representative Office Romania
Sos. Pipera-Tunari nr. 1/1
building 1, 2nd floor | 077190 Voluntari, Ilfov
Tel.: +40-(0)31 421 85 68 | Email: info-RO@wago.com

Aveți întrebări despre produsele noastre?
Vă stăm la dispoziție pentru preluarea apelului la +40 (0) 31 421 85 68.

Produse compatibile

clamps

| | | |
|--|---|--|
|  | Nr. articol: 2002-1661 2-conductor carrier terminal block; for DIN-rail 35 x 15 and 35 x 7.5; 2.5 mm ² ; Push-in CAGE CLAMP®; 2,50 mm ² ; gray | www.wago.com/2002-1661 |
|  | Nr. articol: 2002-1662 2-conductor carrier terminal block; for DIN-rail 35 x 15 and 35 x 7.5; 2.5 mm ² ; Push-in CAGE CLAMP®; 2,50 mm ² ; orange | www.wago.com/2002-1662 |
|  | Nr. articol: 2002-1761 3-conductor carrier terminal block; for DIN-rail 35 x 15 and 35 x 7.5; 2.5 mm ² ; Push-in CAGE CLAMP®; 2,50 mm ² ; gray | www.wago.com/2002-1761 |
|  | Nr. articol: 2002-1861 4-conductor carrier terminal block; for DIN-rail 35 x 15 and 35 x 7.5; 2.5 mm ² ; Push-in CAGE CLAMP®; 2,50 mm ² ; gray | www.wago.com/2002-1861 |
|  | Nr. articol: 2002-1961 2-conductor carrier terminal block; with additional jumper position; for DIN-rail 35 x 15 and 35 x 7.5; 2.5 mm ² ; Push-in CAGE CLAMP®; 2,50 mm ² ; gray | www.wago.com/2002-1961 |
|  | Nr. articol: 2002-2941 Double-deck, double-disconnect terminal block; L/L; for DIN-rail 35 x 15 and 35 x 7.5; 2.5 mm ² ; Push-in CAGE CLAMP®; 2,50 mm ² ; gray | www.wago.com/2002-2941 |
|  | Nr. articol: 2002-2961 Double-deck carrier terminal block; L/L; for DIN-rail 35 x 15 and 35 x 7.5; 2.5 mm ² ; Push-in CAGE CLAMP®; 2,50 mm ² ; gray | www.wago.com/2002-2961 |
|  | Nr. articol: 2002-2963 Double-deck carrier terminal block; L/N; for DIN-rail 35 x 15 and 35 x 7.5; 2.5 mm ² ; Push-in CAGE CLAMP®; 2,50 mm ² ; gray | www.wago.com/2002-2963 |
|  | Nr. articol: 2003-6640 Multilevel installation terminal block; 4 mm ² ; Carrier terminal block without knife; N/L/PE; Push-in CAGE CLAMP®; 2,50 mm ² ; gray | www.wago.com/2003-6640 |
|  | Nr. articol: 2003-6643 Multilevel installation terminal block; 4 mm ² ; Carrier terminal block without knife; P2/P1/PE; black upper deck; brown middle deck; green-yellow lower deck; Push-in CAGE CLAMP®; 2,50 mm ² ; gray | www.wago.com/2003-6643 |
|  | Nr. articol: 2003-6660 Multilevel installation terminal block; 4 mm ² ; Carrier terminal block without knife; P1/P2/PE; brown upper-deck; black middle-deck; green-yellow lower deck; Push-in CAGE CLAMP®; 2,50 mm ² ; gray | www.wago.com/2003-6660 |

General accessories















| | | |
|--|--|--|
|  | Nr. articol: 281-503 Shorting link; 5 x 20 mm; if the fuse plug is used as disconnect plug | www.wago.com/281-503 |
|--|--|--|

Marking accessories

| | | |
|--|--|--|
|  | Nr. articol: 2009-110 Marking strips; on reel; not stretchable; plain; snap-on type; white | www.wago.com/2009-110 |
|--|--|--|

Nr. articol: 2009-115

Supus modificărilor.

| | | |
|--|--|--|
|  | WMB-Inline; for Smart Printer; 1500 pieces on roll; stretchable 5 - 5.2 mm; plain; snap-on type; white | www.wago.com/2009-115 |
|  | Nr. articol: 2009-115/000-002 WMB-Inline; for Smart Printer; 1500 pieces on roll; stretchable 5 - 5.2 mm; plain; snap-on type; yellow | www.wago.com/2009-115/000-002 |
|  | Nr. articol: 2009-115/000-006 WMB-Inline; for Smart Printer; 1500 pieces on roll; stretchable 5 - 5.2 mm; plain; snap-on type; blue | www.wago.com/2009-115/000-006 |
|  | Nr. articol: 2009-115/000-007 WMB-Inline; for Smart Printer; 1500 pieces on roll; stretchable 5 - 5.2 mm; plain; snap-on type; gray | www.wago.com/2009-115/000-007 |
|  | Nr. articol: 2009-115/000-012 WMB-Inline; for Smart Printer; 1500 pieces on roll; stretchable 5 - 5.2 mm; plain; snap-on type; orange | www.wago.com/2009-115/000-012 |
|  | Nr. articol: 2009-115/000-017 WMB-Inline; for Smart Printer; 1500 pieces on roll; stretchable 5 - 5.2 mm; plain; snap-on type; light green | www.wago.com/2009-115/000-017 |
|  | Nr. articol: 2009-115/000-023 WMB-Inline; for Smart Printer; 1500 pieces on roll; stretchable 5 - 5.2 mm; plain; snap-on type; green | www.wago.com/2009-115/000-023 |
|  | Nr. articol: 2009-115/000-024 WMB-Inline; for Smart Printer; 1500 pieces on roll; stretchable 5 - 5.2 mm; plain; snap-on type; violet | www.wago.com/2009-115/000-024 |
|  | Nr. articol: 793-501 WMB marking card; as card; not stretchable; plain; snap-on type; white | www.wago.com/793-501 |
|  | Nr. articol: 793-501/000-002 WMB marking card; as card; not stretchable; plain; snap-on type; yellow | www.wago.com/793-501/000-002 |
|  | Nr. articol: 793-501/000-005 WMB marking card; as card; not stretchable; plain; snap-on type; red | www.wago.com/793-501/000-005 |
|  | Nr. articol: 793-501/000-006 WMB marking card; as card; not stretchable; plain; snap-on type; blue | www.wago.com/793-501/000-006 |
|  | Nr. articol: 793-501/000-007 WMB marking card; as card; not stretchable; plain; snap-on type; gray | www.wago.com/793-501/000-007 |
|  | Nr. articol: 793-501/000-012 WMB marking card; as card; not stretchable; plain; snap-on type; orange | www.wago.com/793-501/000-012 |

Supus modificărilor.

WAGO Kontakttechnik GmbH & Co. KG
 /Representative Office Romania
 Sos. Pipera-Tunari nr. 1/1
 building 1, 2nd floor | 077190 Voluntari, Ilfov
 Tel.: +40-(0)31 421 85 68 | Email: info-RO@wago.com

Aveți întrebări despre produsele noastre?
 Vă stăm la dispoziție pentru preluarea apelului la +40 (0) 31 421 85 68.

**Nr. articol: 793-501/000-017**

WMB marking card; as card; not stretchable; plain; snap-on type; light green

www.wago.com/793-501/000-017**Nr. articol: 793-501/000-023**

WMB marking card; as card; not stretchable; plain; snap-on type; green

www.wago.com/793-501/000-023**Nr. articol: 793-501/000-024**

WMB marking card; as card; not stretchable; plain; snap-on type; violet

www.wago.com/793-501/000-024**Nr. articol: 793-5501**

WMB marking card; as card; for terminal block width 5 - 17.5 mm; stretchable 5 - 5.2 mm; plain; snap-on type; white

www.wago.com/793-5501**Nr. articol: 793-5501/000-002**

WMB marking card; as card; for terminal block width 5 - 17.5 mm; stretchable 5 - 5.2 mm; plain; snap-on type; yellow

www.wago.com/793-5501/000-002**Nr. articol: 793-5501/000-005**

WMB marking card; as card; for terminal block width 5 - 17.5 mm; stretchable 5 - 5.2 mm; plain; snap-on type; red

www.wago.com/793-5501/000-005**Nr. articol: 793-5501/000-006**

WMB marking card; as card; for terminal block width 5 - 17.5 mm; stretchable 5 - 5.2 mm; plain; snap-on type; blue

www.wago.com/793-5501/000-006**Nr. articol: 793-5501/000-007**

WMB marking card; as card; for terminal block width 5 - 17.5 mm; stretchable 5 - 5.2 mm; plain; snap-on type; gray

www.wago.com/793-5501/000-007**Nr. articol: 793-5501/000-012**

WMB marking card; as card; for terminal block width 5 - 17.5 mm; stretchable 5 - 5.2 mm; plain; snap-on type; orange

www.wago.com/793-5501/000-012**Nr. articol: 793-5501/000-014**

WMB marking card; as card; for terminal block width 5 - 17.5 mm; stretchable 5 - 5.2 mm; plain; snap-on type; brown

www.wago.com/793-5501/000-014**Nr. articol: 793-5501/000-017**

WMB marking card; as card; for terminal block width 5 - 17.5 mm; stretchable 5 - 5.2 mm; plain; snap-on type; green

www.wago.com/793-5501/000-017**Nr. articol: 793-5501/000-023**

WMB marking card; as card; for terminal block width 5 - 17.5 mm; stretchable 5 - 5.2 mm; plain; snap-on type; light green

www.wago.com/793-5501/000-023**Nr. articol: 793-5501/000-024**

WMB marking card; as card; for terminal block width 5 - 17.5 mm; stretchable 5 - 5.2 mm; plain; snap-on type; violet

www.wago.com/793-5501/000-024

Supus modificărilor.

Descărcări Documentation

Additional Information
Technical explanations

Apr 3, 2019

pdf
2,1 MB

Descărcare

Installation Notes

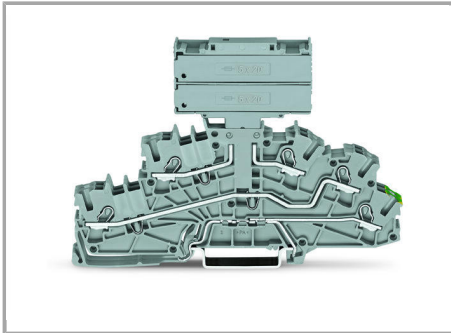

Double-fuse plugs with (5 x 25) mm miniature metric fuses can be used on carrier terminal blocks without N-knife disconnect in standard terminal block width.

Familie de produse

TOPJOB® S

TOPJOB® S: In various industrial applications and modern building installations, WAGO's wide and versatile range of rail-mount terminal blocks provides more than just reliable electrical connections.

[Afișare globală produse din familie.](#)

Supus modificărilor.