

## Fișă tehnică | Număr articol: 769-634/000-036

THT male header; 1.0 x 1.0 mm solder pin; straight; Pin spacing 5 mm; 4-pole; gray

[www.wago.com/769-634/000-036](http://www.wago.com/769-634/000-036)

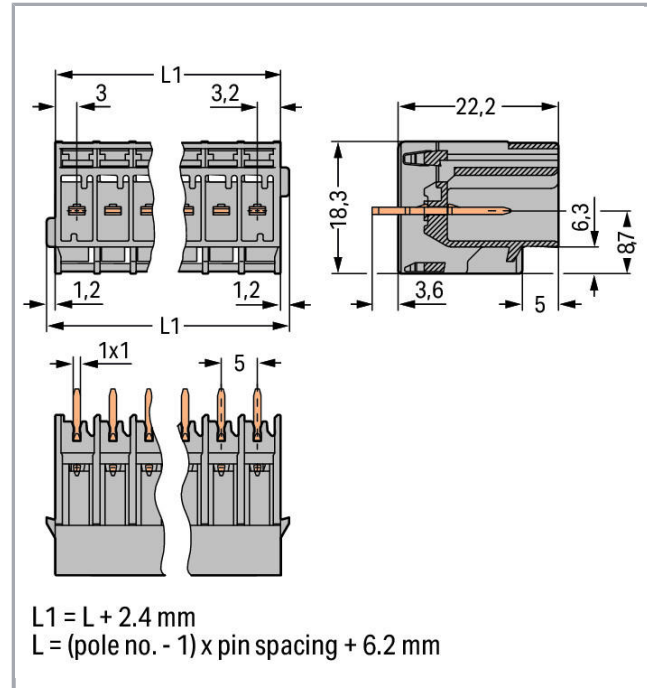
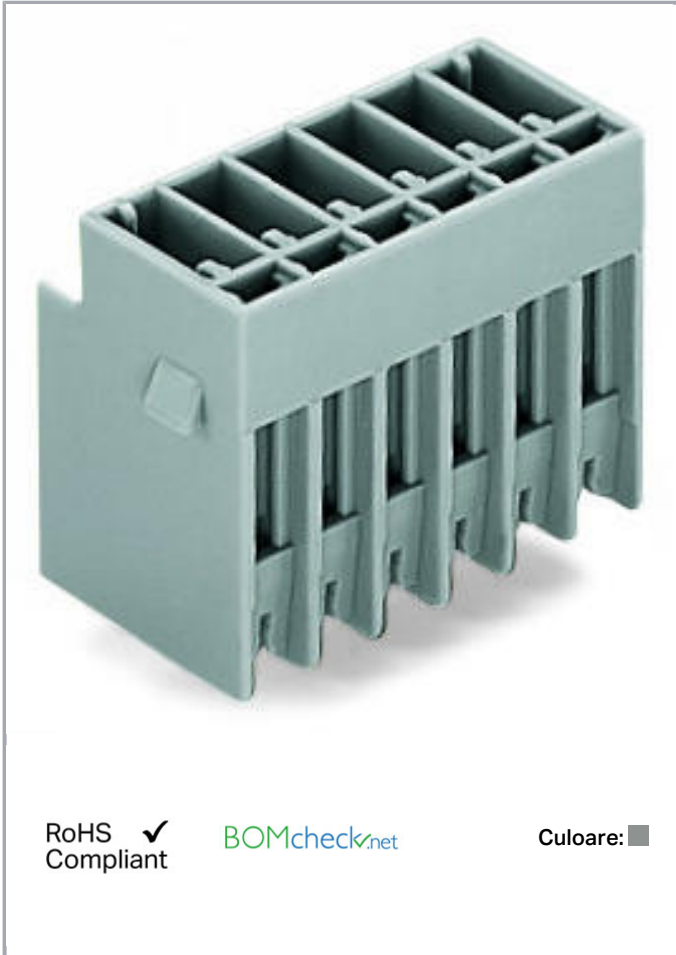

RoHS  Compliant

[BOMcheck.net](https://www.bomcheck.net)

Culoare: ■

### Date

#### Electrical data

#### Ratings per IEC/EN 60664-1

Nominal voltage (III/3)	250 V
Rated surge voltage (III/3)	4 kV
Rated voltage (III/2)	500 V
Rated surge voltage (III/2)	4 kV
Rated current	32 A

Supus modificărilor.

WAGO Kontakttechnik GmbH & Co. KG  
/Representative Office Romania  
Sos. Pipera-Tunari nr. 1/1  
building 1, 2nd floor | 077190 Voluntari, Ilfov  
Tel.: +40-(0)31 421 85 68 | Email: [info-RO@wago.com](mailto:info-RO@wago.com)

Aveți întrebări despre produsele noastre?  
Vă stăm la dispoziție pentru preluarea apelului la +40 (0) 31 421 85 68.



Legend (ratings)

(III / 3) ≙ Overvoltage category III / Pollution degree 3

**Connection data**

Pole No.	4
Total number of potentials	4
Number of levels	1

**Geometrical Data**

Pin spacing	5 mm / 0.197 inch
Width	23.6 mm / 0.929 inch
Height from the surface	22.2 mm / 0.874 inch
Depth	18.3 mm / 0.72 inch

**Plug connection**

Contact type (pluggable connector)	Male connector/plug
Connector (connection type)	for PCBs
Mismating protection	No
Mating direction to the PCB	90°

**PCB contact**

PCB contact	THT
-------------	-----

**Material Data**

Color	gray
Insulation material	Polyamide 66 (PA 66)
Weight	4,4 g

**Commercial data**

Packaging type	BOX
Country of origin	PL
GTIN	4055143296366
Customs tariff number	85366990990

**Aprobări / certificate****Country specific Approvals**

Nume



Supus modificărilor.

WAGO Kontakttechnik GmbH & Co. KG  
 /Representative Office Romania  
 Sos. Pipera-Tunari nr. 1/1  
 building 1, 2nd floor | 077190 Voluntari, Ilfov  
 Tel.: +40-(0)31 421 85 68 | Email: info-RO@wago.com

Aveți întrebări despre produsele noastre?  
 Vă stăm la dispoziție pentru preluarea apelului la +40 (0) 31 421 85 68.

Emblemă	Aprobare	Text de aprobare suplimentar	certificat
	CSA DEKRA Certification B.V.	C22.2 No. 158	1101144

## UL-Approvals

Emblemă	Aprobare	Text de aprobare suplimentar	Nume certificat
	UR Underwriters Laboratories Inc.	UL 1977	20151210- E45171
	UR Underwriters Laboratories Inc.	UL 1059	20190731- E45172

## Counterpart

## Produse compatibile















## Female plug

	<b>Nr. articol: 769-101</b> 1-conductor female plug; 4 mm <sup>2</sup> ; 1-pole; 4,00 mm <sup>2</sup> ; gray	<a href="http://www.wago.com/769-101">www.wago.com/769-101</a>
	<b>Nr. articol: 769-102</b> 1-conductor female plug; 4 mm <sup>2</sup> ; 2-pole; 4,00 mm <sup>2</sup> ; gray	<a href="http://www.wago.com/769-102">www.wago.com/769-102</a>
	<b>Nr. articol: 769-102/000-036</b> 1-conductor female plug; 4 mm <sup>2</sup> ; 2-pole; 4,00 mm <sup>2</sup> ; gray, green-yellow	<a href="http://www.wago.com/769-102/000-036">www.wago.com/769-102/000-036</a>
	<b>Nr. articol: 769-102/000-037</b> 1-conductor female plug; 4 mm <sup>2</sup> ; 2-pole; 4,00 mm <sup>2</sup> ; green-yellow, gray	<a href="http://www.wago.com/769-102/000-037">www.wago.com/769-102/000-037</a>
	<b>Nr. articol: 769-103</b> 1-conductor female plug; 4 mm <sup>2</sup> ; 3-pole; 4,00 mm <sup>2</sup> ; gray	<a href="http://www.wago.com/769-103">www.wago.com/769-103</a>
	<b>Nr. articol: 769-103/000-036</b> 1-conductor female plug; 4 mm <sup>2</sup> ; 3-pole; 4,00 mm <sup>2</sup> ; gray, green-yellow	<a href="http://www.wago.com/769-103/000-036">www.wago.com/769-103/000-036</a>

## Supus modificărilor.

WAGO Kontakttechnik GmbH & Co. KG  
/Representative Office Romania  
Sos. Pipera-Tunari nr. 1/1  
building 1, 2nd floor | 077190 Voluntari, Ilfov  
Tel.: +40-(0)31 421 85 68 | Email: info-RO@wago.com

Aveți întrebări despre produsele noastre?  
Vă stăm la dispoziție pentru preluarea apelului la +40 (0) 31 421 85 68.

	<b>Nr. articol: 769-103/000-037</b> 1-conductor female plug; 4 mm <sup>2</sup> ; 3-pole; 4,00 mm <sup>2</sup> ; green-yellow, gray	<a href="http://www.wago.com/769-103/000-037">www.wago.com/769-103/000-037</a>
	<b>Nr. articol: 769-103/000-038</b> 1-conductor female plug; 4 mm <sup>2</sup> ; 3-pole; 4,00 mm <sup>2</sup> ; gray, blue, green-yellow	<a href="http://www.wago.com/769-103/000-038">www.wago.com/769-103/000-038</a>
	<b>Nr. articol: 769-103/000-039</b> 1-conductor female plug; 4 mm <sup>2</sup> ; 3-pole; 4,00 mm <sup>2</sup> ; green-yellow, blue, gray	<a href="http://www.wago.com/769-103/000-039">www.wago.com/769-103/000-039</a>
	<b>Nr. articol: 769-104</b> 1-conductor female plug; 4 mm <sup>2</sup> ; 4-pole; 4,00 mm <sup>2</sup> ; gray	<a href="http://www.wago.com/769-104">www.wago.com/769-104</a>
	<b>Nr. articol: 769-104/000-036</b> 1-conductor female plug; 4 mm <sup>2</sup> ; 4-pole; 4,00 mm <sup>2</sup> ; gray, green-yellow	<a href="http://www.wago.com/769-104/000-036">www.wago.com/769-104/000-036</a>
	<b>Nr. articol: 769-104/000-037</b> 1-conductor female plug; 4 mm <sup>2</sup> ; 4-pole; 4,00 mm <sup>2</sup> ; green-yellow, gray	<a href="http://www.wago.com/769-104/000-037">www.wago.com/769-104/000-037</a>
	<b>Nr. articol: 769-104/000-038</b> 1-conductor female plug; 4 mm <sup>2</sup> ; 4-pole; 4,00 mm <sup>2</sup> ; gray, blue, green-yellow	<a href="http://www.wago.com/769-104/000-038">www.wago.com/769-104/000-038</a>
	<b>Nr. articol: 769-104/000-039</b> 1-conductor female plug; 4 mm <sup>2</sup> ; 4-pole; 4,00 mm <sup>2</sup> ; green-yellow, blue, gray	<a href="http://www.wago.com/769-104/000-039">www.wago.com/769-104/000-039</a>
	<b>Nr. articol: 769-104/021-000</b> 1-conductor female plug; Locking lever; 4 mm <sup>2</sup> ; 4-pole; 4,00 mm <sup>2</sup> ; gray	<a href="http://www.wago.com/769-104/021-000">www.wago.com/769-104/021-000</a>
	<b>Nr. articol: 769-121</b> 2-conductor female connector; 4 mm <sup>2</sup> ; 1-pole; 4,00 mm <sup>2</sup> ; gray	<a href="http://www.wago.com/769-121">www.wago.com/769-121</a>
	<b>Nr. articol: 769-122</b> 2-conductor female connector; 4 mm <sup>2</sup> ; 2-pole; 4,00 mm <sup>2</sup> ; gray	<a href="http://www.wago.com/769-122">www.wago.com/769-122</a>
	<b>Nr. articol: 769-123</b> 2-conductor female connector; 4 mm <sup>2</sup> ; 3-pole; 4,00 mm <sup>2</sup> ; gray	<a href="http://www.wago.com/769-123">www.wago.com/769-123</a>
	<b>Nr. articol: 769-124</b> 2-conductor female connector; 4 mm <sup>2</sup> ; 4-pole; 4,00 mm <sup>2</sup> ; gray	<a href="http://www.wago.com/769-124">www.wago.com/769-124</a>
<b>Coding</b>		
	<b>Nr. articol: 769-435</b> Coding pin; for coding of female plugs; for carrier terminal blocks / male connectors; orange	<a href="http://www.wago.com/769-435">www.wago.com/769-435</a>

Supus modificărilor.



## Descărcări

### Documentation

#### Additional Information

Technical explanations

Apr 3, 2019

pdf  
2,1 MB

Descărcare

## CAD/CAE-Data

### PCB Design

Symbol and Footprint 769-634/000-036

URL

Descărcare

CAD data for your PCB design, consisting of "schematic symbols and PCB footprints", allow easy integration of the WAGO component into your development environment.

#### Supported formats:

- Accel EDA 14 & 15
- Altium 6 to current version
- Cadence Allegro
- DesignSpark
- Eagle Libraries
- KiCad
- Mentor Graphics BoardStation
- Mentor Graphics Design Architect
- Mentor Graphics Design Expedition 99 and 2000
- OrCAD 9.X PCB and Capture
- PADS PowerPCB 3, 3.5, 4.X, and 5.X
- PADS PowerPCB and PowerLogic 3.0
- PCAD 2000, 2001, 2002, 2004, and 2006
- Pulsonix 8.5 or newer
- STL
- 3D STEP
- TARGET 3001!
- View Logic ViewDraw
- Quadcept
- Zuken CadStar 3 and 4
- Zuken CR-5000 and CR-8000

PCB Component Libraries (EDA), PCB CAD Library Ultra Librarian

Supus modificărilor.

WAGO Kontakttechnik GmbH & Co. KG  
 /Representative Office Romania  
 Sos. Pipera-Tunari nr. 1/1  
 building 1, 2nd floor | 077190 Voluntari, Ilfov  
 Tel.: +40-(0)31 421 85 68 | Email: info-RO@wago.com

Aveți întrebări despre produsele noastre?  
 Vă stăm la dispoziție pentru preluarea apelului la +40 (0) 31 421 85 68.

## Installation Notes

### Assembly

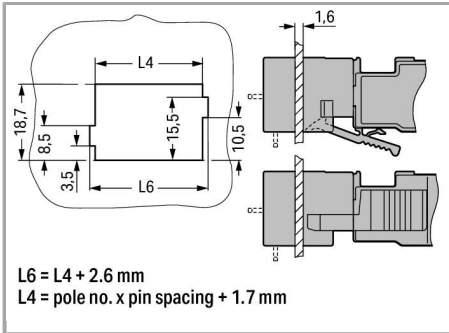

### Cutout

Male headers with solder pins

### Application

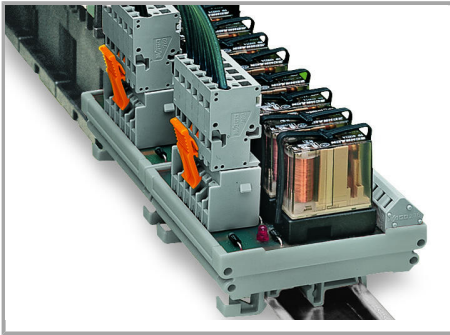

Male headers with straight solder pins and 1-conductor female plugs (picture shows a relay module)

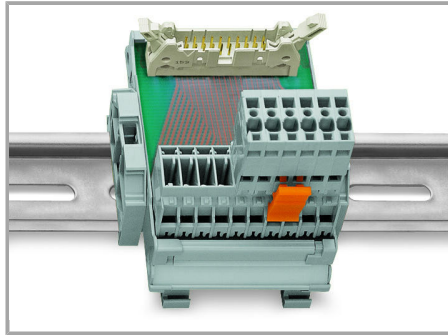

Male headers with solder pins for printed circuit boards

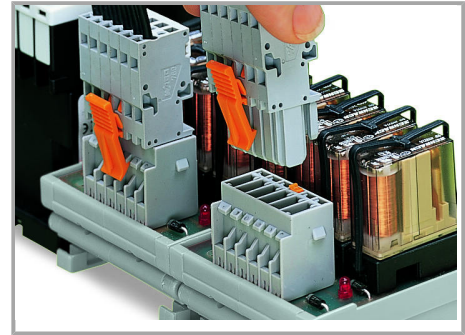

Pluggable PCB connection

Connection to a relay module inside the switchgear cabinet

Supus modificărilor.

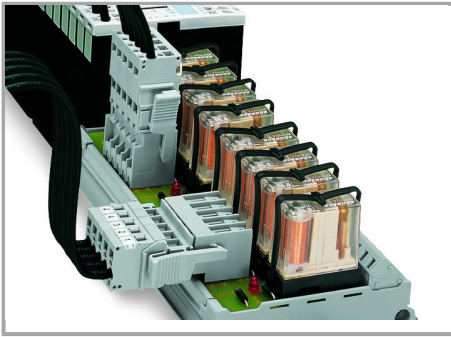

Male headers with solder pins:

Integrating PCB components into the system wiring.

## Familie de produse

### X-COM

[Afișare globală produse din familie.](#)

Supus modificărilor.