

Fișă tehnică | Număr articol: 769-613/005-000

1-conductor male connector; Snap-in flange; 4 mm²; Pin spacing 5 mm; 13-pole; 4,00 mm²; gray

www.wago.com/769-613/005-000



RoHS Compliant

BOMcheck.net

Culoare: ■

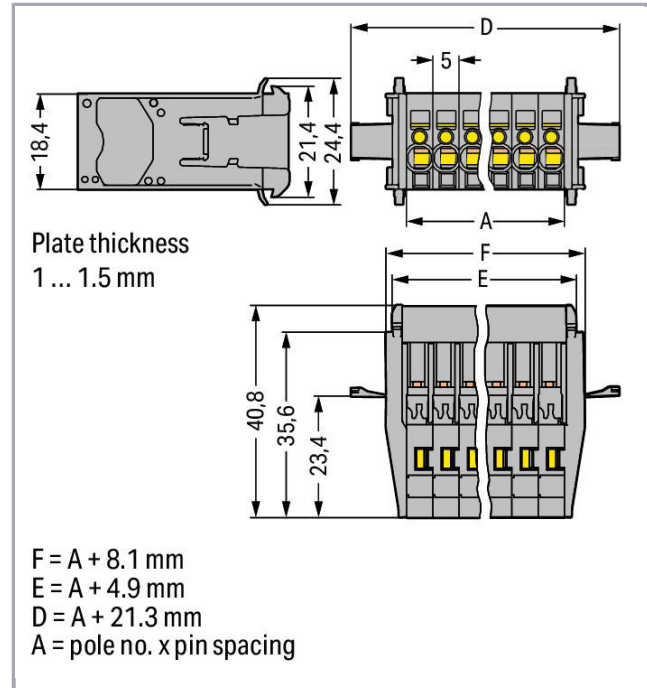

Date

Electrical data

Ratings per IEC/EN 60664-1

| | |
|-----------------------------|---|
| Nominal voltage (III/3) | 500 V |
| Rated surge voltage (III/3) | 6 kV |
| Rated current | 32 A |
| Legend (ratings) | (III / 3) ≙ Overvoltage category III / Pollution degree 3 |

Connection data

| | |
|---------------------------------|----------------|
| Connection technology | CAGE CLAMP® |
| Actuation type | Operating tool |
| Connectable conductor materials | Copper |

Supus modificărilor.

WAGO Kontakttechnik GmbH & Co. KG
/Representative Office Romania
Sos. Pipera-Tunari nr. 1/1
building 1, 2nd floor | 077190 Voluntari, Ilfov
Tel.: +40-(0)31 421 85 68 | Email: info-RO@wago.com

Aveți întrebări despre produsele noastre?
Vă stăm la dispoziție pentru preluarea apelului la +40 (0) 31 421 85 68.



| | |
|-----------------------------------|--|
| Nominal cross-section | 4 mm ² |
| Solid conductor | 0.08 ... 4 mm ² / 28 ... 12 AWG |
| Fine-stranded conductor | 0.08 ... 4 mm ² / 28 ... 12 AWG |
| Strip length | 8 ... 9 mm / 0.31 ... 0.35 inch |
| Pole No. | 13 |
| Total number of connection points | 13 |
| Total number of potentials | 13 |
| Wiring type | Front-entry wiring |

Geometrical Data

| | |
|-------------|----------------------|
| Pin spacing | 5 mm / 0.197 inch |
| Width | 86.3 mm / 3.398 inch |
| Height | 24.4 mm / 0.961 inch |
| Depth | 40.8 mm / 1.606 inch |

Mechanical data

| | |
|---------------|---------|
| Mounting type | Snap-in |
|---------------|---------|

Plug connection

| | |
|------------------------------------|---------------------|
| Contact type (pluggable connector) | Male connector/plug |
| Connector (connection type) | for conductors |

Material Data

| | |
|---------------------|----------------------|
| Color | gray |
| Insulation material | Polyamide 66 (PA 66) |
| Fire load | 0,798 MJ |
| Weight | 39,6 g |

Commercial data

| | |
|-----------------------|-------------------|
| Product Group | 18 (X-COM-System) |
| Packaging type | BOX |
| Country of origin | PL |
| GTIN | 4044918854535 |
| Customs tariff number | 85366990990 |



Supus modificărilor.

WAGO Kontakttechnik GmbH & Co. KG
 /Representative Office Romania
 Sos. Pipera-Tunari nr. 1/1
 building 1, 2nd floor | 077190 Voluntari, Ilfov
 Tel.: +40-(0)31 421 85 68 | Email: info-RO@wago.com



Aveți întrebări despre produsele noastre?
 Vă stăm la dispoziție pentru preluarea apelului la +40 (0) 31 421 85 68.

Aprobări / certificate

Country specific Approvals

| Emblemă | Aprobare | Text de aprobare suplimentar | Nume certificat |
|--|---------------------------------|------------------------------|-----------------|
|  | CCA DEKRA Certification B.V. | EN 61984 | 2190419.02 |
|  | CSA DEKRA Certification B.V. | C22.2 No. 158 | 1101144 |

UL-Approvals

| Emblemă | Aprobare | Text de aprobare suplimentar | Nume certificat |
|--|--------------------------------------|------------------------------|---------------------|
|  | UR Underwriters Laboratories Inc. | UL 1977 | 20151210- E45171 |
|  | UR Underwriters Laboratories Inc. | UL 1059 | 20190731- E45172 |

Counterpart

Produse compatibile

Coding



Nr. articol: 769-435

Coding pin; for coding of female plugs; for carrier terminal blocks / male connectors; orange















www.wago.com/769-435

Female plug

Supus modificărilor.

WAGO Kontakttechnik GmbH & Co. KG
/Representative Office Romania
Sos. Pipera-Tunari nr. 1/1
building 1, 2nd floor | 077190 Voluntari, Ilfov
Tel.: +40-(0)31 421 85 68 | Email: info-RO@wago.com

Aveți întrebări despre produsele noastre?
Vă stăm la dispoziție pentru preluarea apelului la +40 (0) 31 421 85 68.

| | | |
|---|---|--|
|  | Nr. articol: 769-101 1-conductor female plug; 4 mm ² ; 1-pole; 4,00 mm ² ; gray | www.wago.com/769-101 |
|  | Nr. articol: 769-101/000-016 1-conductor female plug; 4 mm ² ; 1-pole; 4,00 mm ² ; green-yellow | www.wago.com/769-101/000-016 |
|  | Nr. articol: 769-102 1-conductor female plug; 4 mm ² ; 2-pole; 4,00 mm ² ; gray | www.wago.com/769-102 |
|  | Nr. articol: 769-102/000-036 1-conductor female plug; 4 mm ² ; 2-pole; 4,00 mm ² ; gray, green-yellow | www.wago.com/769-102/000-036 |
|  | Nr. articol: 769-102/000-037 1-conductor female plug; 4 mm ² ; 2-pole; 4,00 mm ² ; green-yellow, gray | www.wago.com/769-102/000-037 |
|  | Nr. articol: 769-103 1-conductor female plug; 4 mm ² ; 3-pole; 4,00 mm ² ; gray | www.wago.com/769-103 |
|  | Nr. articol: 769-103/000-036 1-conductor female plug; 4 mm ² ; 3-pole; 4,00 mm ² ; gray, green-yellow | www.wago.com/769-103/000-036 |
|  | Nr. articol: 769-103/000-037 1-conductor female plug; 4 mm ² ; 3-pole; 4,00 mm ² ; green-yellow, gray | www.wago.com/769-103/000-037 |
|  | Nr. articol: 769-103/000-038 1-conductor female plug; 4 mm ² ; 3-pole; 4,00 mm ² ; gray, blue, green-yellow | www.wago.com/769-103/000-038 |
|  | Nr. articol: 769-103/000-039 1-conductor female plug; 4 mm ² ; 3-pole; 4,00 mm ² ; green-yellow, blue, gray | www.wago.com/769-103/000-039 |
|  | Nr. articol: 769-104 1-conductor female plug; 4 mm ² ; 4-pole; 4,00 mm ² ; gray | www.wago.com/769-104 |
|  | Nr. articol: 769-104/000-036 1-conductor female plug; 4 mm ² ; 4-pole; 4,00 mm ² ; gray, green-yellow | www.wago.com/769-104/000-036 |
|  | Nr. articol: 769-104/000-037 1-conductor female plug; 4 mm ² ; 4-pole; 4,00 mm ² ; green-yellow, gray | www.wago.com/769-104/000-037 |
|  | Nr. articol: 769-104/000-038 1-conductor female plug; 4 mm ² ; 4-pole; 4,00 mm ² ; gray, blue, green-yellow | www.wago.com/769-104/000-038 |

Supus modificărilor.



Nr. articol: 769-104/000-039

1-conductor female plug; 4 mm²; 4-pole; 4,00 mm²; green-yellow, blue, gray

www.wago.com/769-104/000-039



Nr. articol: 769-105

1-conductor female plug; 4 mm²; 5-pole; 4,00 mm²; gray

www.wago.com/769-105



Nr. articol: 769-105/000-036

1-conductor female plug; 4 mm²; 5-pole; 4,00 mm²; gray, green-yellow

www.wago.com/769-105/000-036



Nr. articol: 769-105/000-037

1-conductor female plug; 4 mm²; 5-pole; 4,00 mm²; green-yellow, gray

www.wago.com/769-105/000-037



Nr. articol: 769-105/000-038

1-conductor female plug; 4 mm²; 5-pole; 4,00 mm²; gray, blue, green-yellow

www.wago.com/769-105/000-038



Nr. articol: 769-105/000-039

1-conductor female plug; 4 mm²; 5-pole; 4,00 mm²; green-yellow, blue, gray

www.wago.com/769-105/000-039



Nr. articol: 769-106

1-conductor female plug; 4 mm²; 6-pole; 4,00 mm²; gray

www.wago.com/769-106



Nr. articol: 769-106/000-006

1-conductor female plug; 4 mm²; 6-pole; 4,00 mm²; blue

www.wago.com/769-106/000-006



Nr. articol: 769-106/000-036

1-conductor female plug; 4 mm²; 6-pole; 4,00 mm²; gray, green-yellow

www.wago.com/769-106/000-036



Nr. articol: 769-106/000-037

1-conductor female plug; 4 mm²; 6-pole; 4,00 mm²; green-yellow, gray

www.wago.com/769-106/000-037



Nr. articol: 769-106/000-038

1-conductor female plug; 4 mm²; 6-pole; 4,00 mm²; gray, blue, green-yellow

www.wago.com/769-106/000-038



Nr. articol: 769-106/000-039

1-conductor female plug; 4 mm²; 6-pole; 4,00 mm²; green-yellow, blue, gray

www.wago.com/769-106/000-039



Nr. articol: 769-107

1-conductor female plug; 4 mm²; 7-pole; 4,00 mm²; gray

www.wago.com/769-107



Nr. articol: 769-107/000-036

1-conductor female plug; 4 mm²; 7-pole; 4,00 mm²; gray, green-yellow

www.wago.com/769-107/000-036

Supus modificărilor.



Nr. articol: 769-107/000-037

1-conductor female plug; 4 mm²; 7-pole; 4,00 mm²; green-yellow, gray

www.wago.com/769-107/000-037



Nr. articol: 769-107/000-038

1-conductor female plug; 4 mm²; 7-pole; 4,00 mm²; gray, blue, green-yellow

www.wago.com/769-107/000-038



Nr. articol: 769-107/000-039

1-conductor female plug; 4 mm²; 7-pole; 4,00 mm²; green-yellow, blue, gray

www.wago.com/769-107/000-039



Nr. articol: 769-108

1-conductor female plug; 4 mm²; 8-pole; 4,00 mm²; gray

www.wago.com/769-108



Nr. articol: 769-108/000-036

1-conductor female plug; 4 mm²; 8-pole; 4,00 mm²; gray, green-yellow

www.wago.com/769-108/000-036



Nr. articol: 769-108/000-037

1-conductor female plug; 4 mm²; 8-pole; 4,00 mm²; green-yellow, gray

www.wago.com/769-108/000-037



Nr. articol: 769-108/000-038

1-conductor female plug; 4 mm²; 8-pole; 4,00 mm²; gray, blue, green-yellow

www.wago.com/769-108/000-038



Nr. articol: 769-108/000-039

1-conductor female plug; 4 mm²; 8-pole; 4,00 mm²; green-yellow, blue, gray

www.wago.com/769-108/000-039



Nr. articol: 769-109

1-conductor female plug; 4 mm²; 9-pole; 4,00 mm²; gray

www.wago.com/769-109



Nr. articol: 769-109/000-036

1-conductor female plug; 4 mm²; 9-pole; 4,00 mm²; gray, green-yellow

www.wago.com/769-109/000-036



Nr. articol: 769-109/000-037

1-conductor female plug; 4 mm²; 9-pole; 4,00 mm²; green-yellow, gray

www.wago.com/769-109/000-037



Nr. articol: 769-109/000-038

1-conductor female plug; 4 mm²; 9-pole; 4,00 mm²; gray, blue, green-yellow

www.wago.com/769-109/000-038



Nr. articol: 769-109/000-039

1-conductor female plug; 4 mm²; 9-pole; 4,00 mm²; green-yellow, blue, gray

www.wago.com/769-109/000-039



Nr. articol: 769-110

1-conductor female plug; 4 mm²; 10-pole; 4,00 mm²; gray

www.wago.com/769-110

Supus modificărilor.



Nr. articol: 769-110/000-036

1-conductor female plug; 4 mm²; 10-pole; 4,00 mm²; gray, green-yellow

www.wago.com/769-110/000-036



Nr. articol: 769-110/000-037

1-conductor female plug; 4 mm²; 10-pole; 4,00 mm²; green-yellow, gray

www.wago.com/769-110/000-037



Nr. articol: 769-110/000-038

1-conductor female plug; 4 mm²; 10-pole; 4,00 mm²; gray, blue, green-yellow

www.wago.com/769-110/000-038



Nr. articol: 769-110/000-039

1-conductor female plug; 4 mm²; 10-pole; 4,00 mm²; green-yellow, blue, gray

www.wago.com/769-110/000-039



Nr. articol: 769-111

1-conductor female plug; 4 mm²; 11-pole; 4,00 mm²; gray

www.wago.com/769-111



Nr. articol: 769-111/000-036

1-conductor female plug; 4 mm²; 11-pole; 4,00 mm²; gray, green-yellow

www.wago.com/769-111/000-036



Nr. articol: 769-111/000-037

1-conductor female plug; 4 mm²; 11-pole; 4,00 mm²; green-yellow, gray

www.wago.com/769-111/000-037



Nr. articol: 769-111/000-038

1-conductor female plug; 4 mm²; 11-pole; 4,00 mm²; gray, blue, green-yellow

www.wago.com/769-111/000-038



Nr. articol: 769-111/000-039

1-conductor female plug; 4 mm²; 11-pole; 4,00 mm²; green-yellow, blue, gray

www.wago.com/769-111/000-039



Nr. articol: 769-112

1-conductor female plug; 4 mm²; 12-pole; 4,00 mm²; gray

www.wago.com/769-112



Nr. articol: 769-112/000-036

1-conductor female plug; 4 mm²; 12-pole; 4,00 mm²; gray, green-yellow

www.wago.com/769-112/000-036



Nr. articol: 769-112/000-037

1-conductor female plug; 4 mm²; 12-pole; 4,00 mm²; green-yellow, gray

www.wago.com/769-112/000-037



Nr. articol: 769-112/000-038

1-conductor female plug; 4 mm²; 12-pole; 4,00 mm²; gray, blue, green-yellow

www.wago.com/769-112/000-038



















Nr. articol: 769-112/000-039

1-conductor female plug; 4 mm²; 12-pole; 4,00 mm²; green-yellow, blue, gray

www.wago.com/769-112/000-039

Supus modificărilor.

| | | |
|--|--|--|
|  | Nr. articol: 769-113 1-conductor female plug; 4 mm ² ; 13-pole; 4,00 mm ² ; gray | www.wago.com/769-113 |
|  | Nr. articol: 769-113/000-036 1-conductor female plug; 4 mm ² ; 13-pole; 4,00 mm ² ; gray, green-yellow | www.wago.com/769-113/000-036 |
|  | Nr. articol: 769-113/000-037 1-conductor female plug; 4 mm ² ; 13-pole; 4,00 mm ² ; green-yellow, gray | www.wago.com/769-113/000-037 |
|  | Nr. articol: 769-113/000-038 1-conductor female plug; 4 mm ² ; 13-pole; 4,00 mm ² ; gray, blue, green-yellow | www.wago.com/769-113/000-038 |
|  | Nr. articol: 769-113/000-039 1-conductor female plug; 4 mm ² ; 13-pole; 4,00 mm ² ; green-yellow, blue, gray | www.wago.com/769-113/000-039 |
|  | Nr. articol: 769-113/021-000 1-conductor female plug; Locking lever; 4 mm ² ; 13-pole; 4,00 mm ² ; gray | www.wago.com/769-113/021-000 |
|  | Nr. articol: 769-121 2-conductor female connector; 4 mm ² ; 1-pole; 4,00 mm ² ; gray | www.wago.com/769-121 |
|  | Nr. articol: 769-121/000-016 2-conductor female connector; 4 mm ² ; 1-pole; 4,00 mm ² ; green-yellow | www.wago.com/769-121/000-016 |
|  | Nr. articol: 769-122 2-conductor female connector; 4 mm ² ; 2-pole; 4,00 mm ² ; gray | www.wago.com/769-122 |
|  | Nr. articol: 769-123 2-conductor female connector; 4 mm ² ; 3-pole; 4,00 mm ² ; gray | www.wago.com/769-123 |
|  | Nr. articol: 769-124 2-conductor female connector; 4 mm ² ; 4-pole; 4,00 mm ² ; gray | www.wago.com/769-124 |
|  | Nr. articol: 769-125 2-conductor female connector; 4 mm ² ; 5-pole; 4,00 mm ² ; gray | www.wago.com/769-125 |
|  | Nr. articol: 769-126 2-conductor female connector; 4 mm ² ; 6-pole; 4,00 mm ² ; gray | www.wago.com/769-126 |
|  | Nr. articol: 769-127 2-conductor female connector; 4 mm ² ; 7-pole; 4,00 mm ² ; gray | www.wago.com/769-127 |
|  | Nr. articol: 769-128 2-conductor female connector; 4 mm ² ; 8-pole; 4,00 mm ² ; gray | www.wago.com/769-128 |
|  | Nr. articol: 769-129 2-conductor female connector; 4 mm ² ; 9-pole; 4,00 mm ² ; gray | www.wago.com/769-129 |

Supus modificărilor.



Nr. articol: 769-130
2-conductor female connector; 4 mm²; 10-pole; 4,00 mm²; gray

www.wago.com/769-130



Nr. articol: 769-131
2-conductor female connector; 4 mm²; 11-pole; 4,00 mm²; gray

www.wago.com/769-131



Nr. articol: 769-132
2-conductor female connector; 4 mm²; 12-pole; 4,00 mm²; gray

www.wago.com/769-132



Nr. articol: 769-133
2-conductor female connector; 4 mm²; 13-pole; 4,00 mm²; gray

www.wago.com/769-133

Protective Warning Marker



Nr. articol: 280-415
Protective warning marker; with high-voltage symbol, black; for 5 terminal blocks; yellow

www.wago.com/280-415

ferrule



Nr. articol: 216-101
Ferrule; Sleeve for 0.5 mm² / AWG 22; uninsulated; electro-tin plated

www.wago.com/216-101



Nr. articol: 216-102
Ferrule; Sleeve for 0.75 mm² / AWG 20; uninsulated; electro-tin plated

www.wago.com/216-102



Nr. articol: 216-103
Ferrule; Sleeve for 1 mm² / AWG 18; uninsulated; electro-tin plated

www.wago.com/216-103



Nr. articol: 216-104
Ferrule; Sleeve for 1.5 mm² / AWG 16; uninsulated; electro-tin plated

www.wago.com/216-104



Nr. articol: 216-201
Ferrule; Sleeve for 0.5 mm² / 20 AWG; insulated; electro-tin plated; white

www.wago.com/216-201



Nr. articol: 216-202
Ferrule; Sleeve for 0.75 mm² / 18 AWG; insulated; electro-tin plated; gray

www.wago.com/216-202



Nr. articol: 216-203
Ferrule; Sleeve for 1 mm² / AWG 18; insulated; electro-tin plated; red

www.wago.com/216-203



Nr. articol: 216-204
Ferrule; Sleeve for 1.5 mm² / AWG 16; insulated; electro-tin plated; black

www.wago.com/216-204



Nr. articol: 216-206
Ferrule; Sleeve for 2.5 mm² / AWG 14; insulated; electro-tin plated; blue

www.wago.com/216-206

Strain relief plate



Nr. articol: 769-410
Strain relief plate; gray

www.wago.com/769-410



Nr. articol: 769-414
Strain relief plate; gray

www.wago.com/769-414

tools

Supus modificărilor.

WAGO Kontakttechnik GmbH & Co. KG
/Representative Office Romania
Sos. Pipera-Tunari nr. 1/1
building 1, 2nd floor | 077190 Voluntari, Ilfov
Tel.: +40-(0)31 421 85 68 | Email: info-RO@wago.com

Aveți întrebări despre produsele noastre?
Vă stăm la dispoziție pentru preluarea apelului la +40 (0) 31 421 85 68.



Nr. articol: 210-490
Operating tool

www.wago.com/210-490



Nr. articol: 769-434
Push-button; loose

www.wago.com/769-434

Insulation stop



Nr. articol: 769-470
Insulation stop; 0.08 - 0.2 mm² "s" (0.14 mm² "f-st"); 5 pieces/strip; white

www.wago.com/769-470



Nr. articol: 769-471
Insulation stop; 0.25 - 0.5 mm²; 5 pieces/strip; light gray

www.wago.com/769-471



Nr. articol: 769-472
Insulation stop; 0.75 - 1 mm²; 5 pieces/strip; dark gray

www.wago.com/769-472

Marking accessories



Nr. articol: 2009-145
Mini-WSB Inline; for Smart Printer; 1700 pieces on roll; stretchable 5 - 5.2 mm; plain; snap-on type; white

www.wago.com/2009-145



Nr. articol: 2009-145/000-002
Mini-WSB Inline; for Smart Printer; 1700 pieces on roll; stretchable 5 - 5.2 mm; plain; snap-on type; yellow

www.wago.com/2009-145/000-002



Nr. articol: 2009-145/000-005
Mini-WSB Inline; for Smart Printer; 1700 pieces on roll; stretchable 5 - 5.2 mm; plain; snap-on type; red

www.wago.com/2009-145/000-005



Nr. articol: 2009-145/000-006
Mini-WSB Inline; for Smart Printer; 1700 pieces on roll; stretchable 5 - 5.2 mm; plain; snap-on type; blue

www.wago.com/2009-145/000-006



Nr. articol: 2009-145/000-007
Mini-WSB Inline; for Smart Printer; 1700 pieces on roll; stretchable 5 - 5.2 mm; plain; snap-on type; gray

www.wago.com/2009-145/000-007



Nr. articol: 2009-145/000-012
Mini-WSB Inline; for Smart Printer; 1700 pieces on roll; stretchable 5 - 5.2 mm; plain; snap-on type; orange

www.wago.com/2009-145/000-012



Nr. articol: 2009-145/000-023
Mini-WSB Inline; for Smart Printer; 1700 pieces on roll; stretchable 5 - 5.2 mm; plain; snap-on type; green

www.wago.com/2009-145/000-023



Nr. articol: 2009-145/000-024
Mini-WSB Inline; for Smart Printer; 1700 pieces on roll; stretchable 5 - 5.2 mm; plain; snap-on type; violet

www.wago.com/2009-145/000-024



Nr. articol: 210-831
Marking strips; on reel; 2.3 mm wide; plain; Self-adhesive; white











www.wago.com/210-831



Nr. articol: 210-832
Marking strips; on reel; 3 mm wide; plain; Self-adhesive; white

www.wago.com/210-832

Supus modificărilor.

| | | |
|--|---|--|
|  | Nr. articol: 210-833 Marking strips; on reel; 6 mm wide; plain; Self-adhesive; white | www.wago.com/210-833 |
|  | Nr. articol: 210-834 Marking strips; on reel; 5 mm wide; plain; Self-adhesive; white | www.wago.com/210-834 |
|  | Nr. articol: 248-501 Miniature WSB Quick marking system; plain; Marker width 5 mm; 10 strips with 10 markers per card | www.wago.com/248-501 |
|  | Nr. articol: 248-501/000-002 Mini-WSB marking card; as card; not stretchable; plain; snap-on type; yellow | www.wago.com/248-501/000-002 |
|  | Nr. articol: 248-501/000-005 Mini-WSB marking card; as card; not stretchable; plain; snap-on type; red | www.wago.com/248-501/000-005 |
|  | Nr. articol: 248-501/000-006 Mini-WSB marking card; as card; not stretchable; plain; snap-on type; blue | www.wago.com/248-501/000-006 |
|  | Nr. articol: 248-501/000-007 Mini-WSB marking card; as card; not stretchable; plain; snap-on type; gray | www.wago.com/248-501/000-007 |
|  | Nr. articol: 248-501/000-012 Mini-WSB marking card; as card; not stretchable; plain; snap-on type; orange | www.wago.com/248-501/000-012 |
|  | Nr. articol: 248-501/000-017 Mini-WSB marking card; as card; not stretchable; plain; snap-on type; light green | www.wago.com/248-501/000-017 |
|  | Nr. articol: 248-501/000-023 Mini-WSB marking card; as card; not stretchable; plain; snap-on type; green | www.wago.com/248-501/000-023 |
|  | Nr. articol: 248-501/000-024 Mini-WSB marking card; as card; not stretchable; plain; snap-on type; violet | www.wago.com/248-501/000-024 |

Descărcări

Documentation

Additional Information

| | | | |
|------------------------|-------------|---------------|------------|
| Technical explanations | Apr 3, 2019 | pdf 2,1 MB | Descărcare |
|------------------------|-------------|---------------|------------|

Supus modificărilor.

WAGO Kontakttechnik GmbH & Co. KG
/Representative Office Romania
Sos. Pipera-Tunari nr. 1/1
building 1, 2nd floor | 077190 Voluntari, Ilfov
Tel.: +40-(0)31 421 85 68 | Email: info-RO@wago.com

Aveți întrebări despre produsele noastre?
Vă stăm la dispoziție pentru preluarea apelului la +40 (0) 31 421 85 68.

CAD/CAE-Data

CAD data

| | | |
|------------------------------|---------------------|----------------------------|
| 2D/3D Models 769-613/005-000 | URL | Descărcare |
|------------------------------|---------------------|----------------------------|

CAE data

| | | |
|-----------------------------------|---------------------|----------------------------|
| EPLAN Data Portal 769-613/005-000 | URL | Descărcare |
|-----------------------------------|---------------------|----------------------------|

| | | |
|--------------------------------|---------------------|----------------------------|
| WSCAD Universe 769-613/005-000 | URL | Descărcare |
|--------------------------------|---------------------|----------------------------|

Installation Notes

Installation

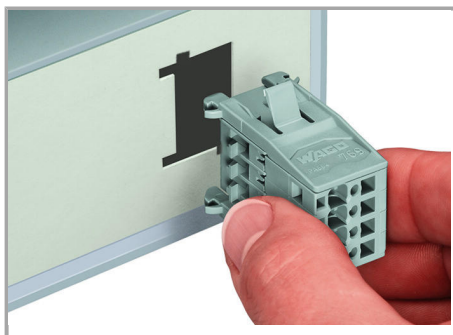

Insert male connector with snap-in flanges (769-604/005-000) into the cutout.



Male connector with snap-in flanges



Snap-in mounting without tools

Snap-in mounting without tools

Supus modificărilor.

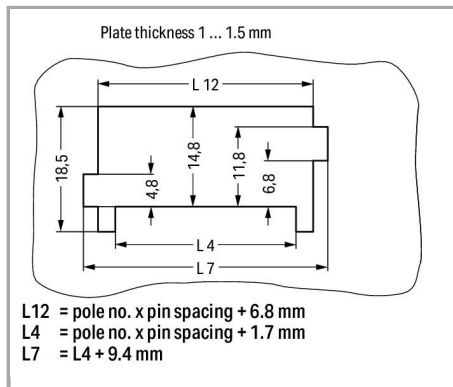

Sheet metal cutout

Male connectors with CAGE CLAMP® connection (769-6xx/005-000) and snap-in flanges

Inserting a conductor

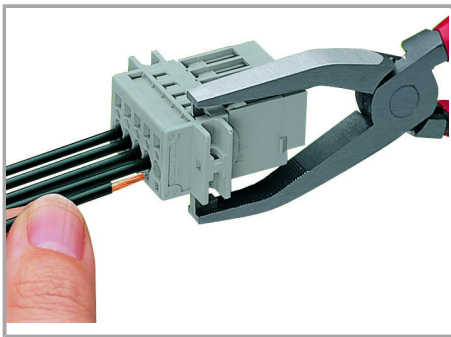

Operating tool

Inserting a conductor via operating tool (example shows a male connector).

Marking

Supus modificărilor.

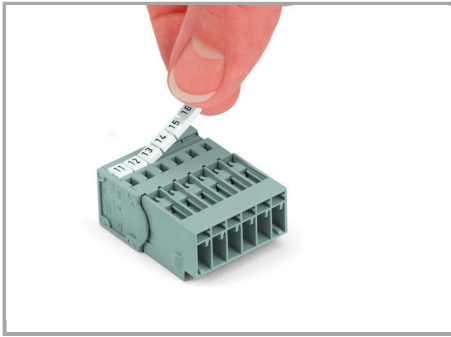

Labeling a male connector with
CAGE CLAMP® connection via Mini-WSB
quick markers.

Familie de produse

X-COM

Afișare globală produse din familie.

Supus modificărilor.