

Fișă tehnică | Număr articol: 769-636/004-000

THT male header; 1.0 x 1.0 mm solder pin; straight; Pin spacing 5 mm; 6-pole; gray



www.wago.com/769-636/004-000



RoHS Compliant

BOMcheck.net

Culoare: ■

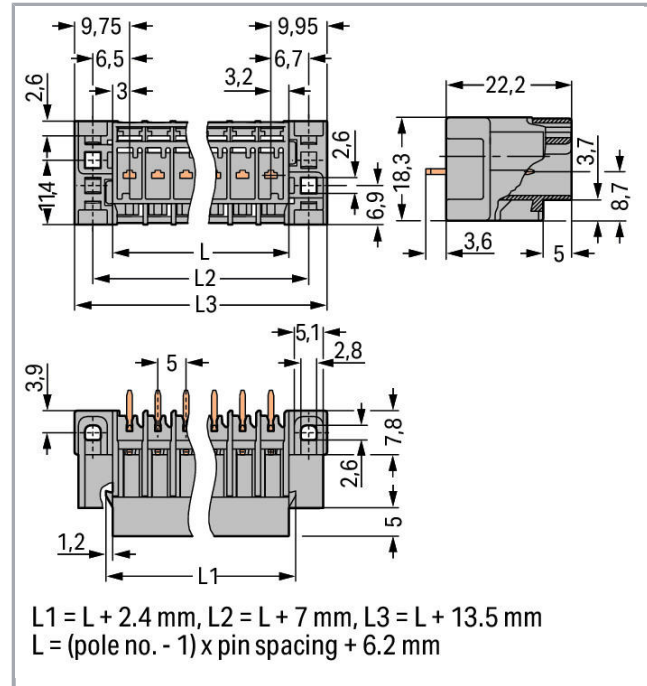

Date

Electrical data

Ratings per IEC/EN 60664-1

Nominal voltage (III/3)	250 V
Rated surge voltage (III/3)	4 kV
Rated voltage (III/2)	500 V
Rated surge voltage (III/2)	4 kV
Rated current	32 A
Legend (ratings)	(III / 3) ≙ Overvoltage category III / Pollution degree 3

Supus modificărilor.

WAGO Kontakttechnik GmbH & Co. KG
/Representative Office Romania
Sos. Pipera-Tunari nr. 1/1
building 1, 2nd floor | 077190 Voluntari, Ilfov
Tel.: +40-(0)31 421 85 68 | Email: info-RO@wago.com

Aveți întrebări despre produsele noastre?
Vă stăm la dispoziție pentru preluarea apelului la +40 (0) 31 421 85 68.

**Connection data**

Pole No.	6
Total number of potentials	6
Number of levels	1

Geometrical Data

Pin spacing	5 mm / 0.197 inch
Width	44,7 mm / 1.76 inch
Height from the surface	22,2 mm / 0.874 inch
Depth	18,3 mm / 0.72 inch

Mechanical data

Mounting type	Mounting flange
---------------	-----------------

Plug connection

Contact type (pluggable connector)	Male connector/plug
Connector (connection type)	for PCB
Mismating protection	No
Mating direction to the PCB	90°

PCB contact

PCB contact	THT
-------------	-----

Material Data

Color	gray
Insulation material	Polyamide 66 (PA 66)
Fire load	0,174 MJ
Weight	7,6 g

Commercial data

Product Group	18 (X-COM-System)
Packaging type	BOX
Country of origin	PL
GTIN	4044918270700

Supus modificărilor.

WAGO Kontakttechnik GmbH & Co. KG
 /Representative Office Romania
 Sos. Pipera-Tunari nr. 1/1
 building 1, 2nd floor | 077190 Voluntari, Ilfov
 Tel.: +40-(0)31 421 85 68 | Email: info-RO@wago.com





Aveți întrebări despre produsele noastre?
 Vă stăm la dispoziție pentru preluarea apelului la +40 (0) 31 421 85 68.

Customs tariff number

85366990990

Aprobări / certificate



Country specific Approvals

Emblemă	Aprobare	Text de aprobare suplimentar	Nume certificat
	CCA DEKRA Certification B.V.	EN 60947	NTR NL-7626
	CCA DEKRA Certification B.V.	EN 61984	2190419.02
	CSA DEKRA Certification B.V.	C22.2 No. 158	1101144
	KEMA/KEUR DEKRA Certification B.V.	EN 60947	2190419.01

Ship Approvals

Emblemă	Aprobare	Text de aprobare suplimentar	Nume certificat
	DNV GL Det Norske Veritas, Germanischer Lloyd	-	TAE00001V2

UL-Approvals

Emblemă	Aprobare	Text de aprobare suplimentar	Nume certificat
	UR Underwriters Laboratories Inc.	UL 1977	20151210-E45171
	UR Underwriters Laboratories Inc.	UL 1059	20190731-E45172

Supus modificărilor.



WAGO Kontakttechnik GmbH & Co. KG
/Representative Office Romania
Sos. Pipera-Tunari nr. 1/1
building 1, 2nd floor | 077190 Voluntari, Ilfov
Tel.: +40-(0)31 421 85 68 | Email: info-RO@wago.com

Aveți întrebări despre produsele noastre?
Vă stăm la dispoziție pentru preluarea apelului la +40 (0) 31 421 85 68.

Counterpart

Produce compatibile







Marking accessories

	Nr. articol: 210-831 Marking strips; on reel; 2.3 mm wide; plain; Self-adhesive; white	www.wago.com/210-831
	Nr. articol: 210-832 Marking strips; on reel; 3 mm wide; plain; Self-adhesive; white	www.wago.com/210-832
	Nr. articol: 210-833 Marking strips; on reel; 6 mm wide; plain; Self-adhesive; white	www.wago.com/210-833
	Nr. articol: 210-834 Marking strips; on reel; 5 mm wide; plain; Self-adhesive; white	www.wago.com/210-834

Coding

	Nr. articol: 769-435 Coding pin; for coding of female plugs; for carrier terminal blocks / male connectors; orange	www.wago.com/769-435
--	--	--















Female plug

	Nr. articol: 769-101 1-conductor female plug; 4 mm ² ; 1-pole; 4,00 mm ² ; gray	www.wago.com/769-101
	Nr. articol: 769-102 1-conductor female plug; 4 mm ² ; 2-pole; 4,00 mm ² ; gray	www.wago.com/769-102
	Nr. articol: 769-102/000-036 1-conductor female plug; 4 mm ² ; 2-pole; 4,00 mm ² ; gray, green-yellow	www.wago.com/769-102/000-036
	Nr. articol: 769-102/000-037 1-conductor female plug; 4 mm ² ; 2-pole; 4,00 mm ² ; green-yellow, gray	www.wago.com/769-102/000-037
	Nr. articol: 769-103 1-conductor female plug; 4 mm ² ; 3-pole; 4,00 mm ² ; gray	www.wago.com/769-103
	Nr. articol: 769-103/000-036 1-conductor female plug; 4 mm ² ; 3-pole; 4,00 mm ² ; gray, green-yellow	www.wago.com/769-103/000-036
	Nr. articol: 769-103/000-037 1-conductor female plug; 4 mm ² ; 3-pole; 4,00 mm ² ; green-yellow, gray	www.wago.com/769-103/000-037











Supus modificărilor.

WAGO Kontakttechnik GmbH & Co. KG
/Representative Office Romania
Sos. Pipera-Tunari nr. 1/1
building 1, 2nd floor | 077190 Voluntari, Ilfov
Tel.: +40-(0)31 421 85 68 | Email: info-RO@wago.com

Aveți întrebări despre produsele noastre?
Vă stăm la dispoziție pentru preluarea apelului la +40 (0) 31 421 85 68.

	Nr. articol: 769-103/000-038 1-conductor female plug; 4 mm ² ; 3-pole; 4,00 mm ² ; gray, blue, green-yellow	www.wago.com/769-103/000-038
	Nr. articol: 769-103/000-039 1-conductor female plug; 4 mm ² ; 3-pole; 4,00 mm ² ; green-yellow, blue, gray	www.wago.com/769-103/000-039
	Nr. articol: 769-104 1-conductor female plug; 4 mm ² ; 4-pole; 4,00 mm ² ; gray	www.wago.com/769-104
	Nr. articol: 769-104/000-036 1-conductor female plug; 4 mm ² ; 4-pole; 4,00 mm ² ; gray, green-yellow	www.wago.com/769-104/000-036
	Nr. articol: 769-104/000-037 1-conductor female plug; 4 mm ² ; 4-pole; 4,00 mm ² ; green-yellow, gray	www.wago.com/769-104/000-037
	Nr. articol: 769-104/000-038 1-conductor female plug; 4 mm ² ; 4-pole; 4,00 mm ² ; gray, blue, green-yellow	www.wago.com/769-104/000-038
	Nr. articol: 769-104/000-039 1-conductor female plug; 4 mm ² ; 4-pole; 4,00 mm ² ; green-yellow, blue, gray	www.wago.com/769-104/000-039
	Nr. articol: 769-105 1-conductor female plug; 4 mm ² ; 5-pole; 4,00 mm ² ; gray	www.wago.com/769-105
	Nr. articol: 769-105/000-036 1-conductor female plug; 4 mm ² ; 5-pole; 4,00 mm ² ; gray, green-yellow	www.wago.com/769-105/000-036
	Nr. articol: 769-105/000-037 1-conductor female plug; 4 mm ² ; 5-pole; 4,00 mm ² ; green-yellow, gray	www.wago.com/769-105/000-037
	Nr. articol: 769-105/000-038 1-conductor female plug; 4 mm ² ; 5-pole; 4,00 mm ² ; gray, blue, green-yellow	www.wago.com/769-105/000-038
	Nr. articol: 769-105/000-039 1-conductor female plug; 4 mm ² ; 5-pole; 4,00 mm ² ; green-yellow, blue, gray	www.wago.com/769-105/000-039
	Nr. articol: 769-106 1-conductor female plug; 4 mm ² ; 6-pole; 4,00 mm ² ; gray	www.wago.com/769-106
	Nr. articol: 769-106/000-006 1-conductor female plug; 4 mm ² ; 6-pole; 4,00 mm ² ; blue	www.wago.com/769-106/000-006

Supus modificărilor.

	Nr. articol: 769-106/000-036 1-conductor female plug; 4 mm ² ; 6-pole; 4,00 mm ² ; gray, green-yellow	www.wago.com/769-106/000-036
	Nr. articol: 769-106/000-037 1-conductor female plug; 4 mm ² ; 6-pole; 4,00 mm ² ; green-yellow, gray	www.wago.com/769-106/000-037
	Nr. articol: 769-106/000-038 1-conductor female plug; 4 mm ² ; 6-pole; 4,00 mm ² ; gray, blue, green-yellow	www.wago.com/769-106/000-038
	Nr. articol: 769-106/000-039 1-conductor female plug; 4 mm ² ; 6-pole; 4,00 mm ² ; green-yellow, blue, gray	www.wago.com/769-106/000-039
	Nr. articol: 769-106/021-000 1-conductor female plug; Locking lever; 4 mm ² ; 6-pole; 4,00 mm ² ; gray	www.wago.com/769-106/021-000
	Nr. articol: 769-121 2-conductor female connector; 4 mm ² ; 1-pole; 4,00 mm ² ; gray	www.wago.com/769-121
	Nr. articol: 769-122 2-conductor female connector; 4 mm ² ; 2-pole; 4,00 mm ² ; gray	www.wago.com/769-122
	Nr. articol: 769-123 2-conductor female connector; 4 mm ² ; 3-pole; 4,00 mm ² ; gray	www.wago.com/769-123
	Nr. articol: 769-124 2-conductor female connector; 4 mm ² ; 4-pole; 4,00 mm ² ; gray	www.wago.com/769-124
	Nr. articol: 769-125 2-conductor female connector; 4 mm ² ; 5-pole; 4,00 mm ² ; gray	www.wago.com/769-125
	Nr. articol: 769-126 2-conductor female connector; 4 mm ² ; 6-pole; 4,00 mm ² ; gray	www.wago.com/769-126

Descărcări

Documentation

Additional Information

Technical explanations	Apr 3, 2019	pdf 2,1 MB	Descărcare
------------------------	-------------	---------------	------------

CAD/CAE-Data

CAD data

2D/3D Models 769-636/004-000	URL	Descărcare
Supus modificărilor.		

PCB Design

Symbol and Footprint 769-636/004-000

URL

Descărcare

CAX data for your PCB design, consisting of "schematic symbols and PCB footprints", allow easy integration of the WAGO component into your development environment.

Supported formats:

- Accel EDA 14 & 15
- Altium 6 to current version
- Cadence Allegro
- DesignSpark
- Eagle Libraries
- KiCad
- Mentor Graphics BoardStation
- Mentor Graphics Design Architect
- Mentor Graphics Design Expedition 99 and 2000
- OrCAD 9.X PCB and Capture
- PADS PowerPCB 3, 3.5, 4.X, and 5.X
- PADS PowerPCB and PowerLogic 3.0
- PCAD 2000, 2001, 2002, 2004, and 2006
- Pulsonix 8.5 or newer
- STL
- 3D STEP
- TARGET 3001!
- View Logic ViewDraw
- Quadcept
- Zuken CadStar 3 and 4
- Zuken CR-5000 and CR-8000

PCB Component Libraries (EDA), PCB CAD Library Ultra Librarian

Installation Notes

Assembly

Supus modificărilor.

WAGO Kontakttechnik GmbH & Co. KG
/Representative Office Romania
Sos. Pipera-Tunari nr. 1/1
building 1, 2nd floor | 077190 Voluntari, Ilfov
Tel.: +40-(0)31 421 85 68 | Email: info-RO@wago.com

Aveți întrebări despre produsele noastre?
Vă stăm la dispoziție pentru preluarea apelului la +40 (0) 31 421 85 68.

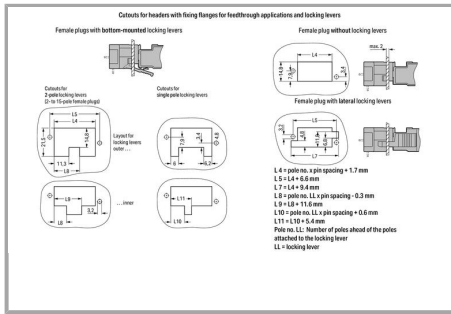

Cutouts for headers with fixing flanges for feedthrough applications and locking levers

Application

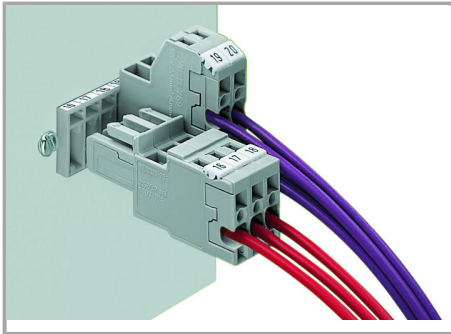

Male header with straight or angled solder pins and feedthrough flanges

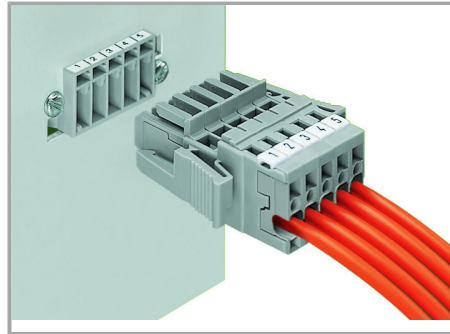

Male header and 1-conductor female plug with lateral locking levers

1-conductor female plug

2-conductor female plug

Familie de produse

X-COM

Afișare globală produse din familie.

Supus modificărilor.

WAGO Kontakttechnik GmbH & Co. KG
 /Representative Office Romania
 Sos. Pipera-Tunari nr. 1/1
 building 1, 2nd floor | 077190 Voluntari, Ilfov
 Tel.: +40-(0)31 421 85 68 | Email: info-RO@wago.com

Aveți întrebări despre produsele noastre?
 Vă stăm la dispoziție pentru preluarea apelului la +40 (0) 31 421 85 68.