

Fișă tehnică | Număr articol: 769-638/004-000

THT male header; 1.0 x 1.0 mm solder pin; straight; Pin spacing 5 mm; 8-pole; gray



www.wago.com/769-638/004-000



RoHS Compliant

BOMcheck.net

Culoare: ■

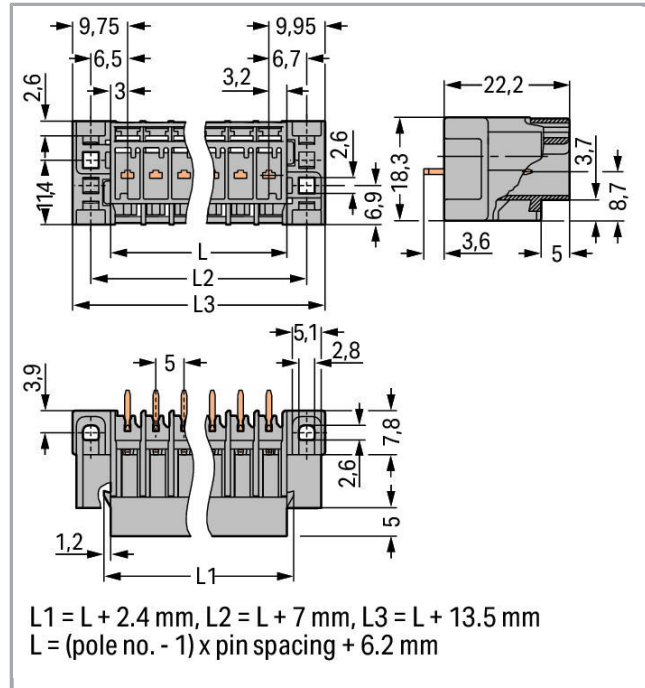

Date

Electrical data

Ratings per IEC/EN 60664-1

Nominal voltage (III/3)	250 V
Rated surge voltage (III/3)	4 kV
Rated voltage (III/2)	500 V
Rated surge voltage (III/2)	4 kV
Rated current	32 A
Legend (ratings)	(III / 3) ≙ Overvoltage category III / Pollution degree 3

Supus modificărilor.

WAGO Kontakttechnik GmbH & Co. KG
/Representative Office Romania
Sos. Pipera-Tunari nr. 1/1
building 1, 2nd floor | 077190 Voluntari, Ilfov
Tel.: +40-(0)31 421 85 68 | Email: info-RO@wago.com

Aveți întrebări despre produsele noastre?
Vă stăm la dispoziție pentru preluarea apelului la +40 (0) 31 421 85 68.

**Connection data**

Pole No.	8
Total number of potentials	8
Number of levels	1

Geometrical Data

Pin spacing	5 mm / 0.197 inch
Width	54.7 mm / 2.154 inch
Height from the surface	22.2 mm / 0.874 inch
Depth	18.3 mm / 0.72 inch

Mechanical data

Mounting type	Mounting flange
---------------	-----------------

Plug connection

Contact type (pluggable connector)	Male connector/plug
Connector (connection type)	for PCBs
Mismating protection	No
Mating direction to the PCB	90°

PCB contact

PCB contact	THT
-------------	-----

Material Data

Color	gray
Insulation material	Polyamide 66 (PA 66)
Fire load	0,211 MJ
Weight	9,4 g

Commercial data

Product Group	18 (X-COM-System)
Packaging type	BOX
Country of origin	PL
GTIN	4044918270731

Supus modificărilor.

WAGO Kontakttechnik GmbH & Co. KG
 /Representative Office Romania
 Sos. Pipera-Tunari nr. 1/1
 building 1, 2nd floor | 077190 Voluntari, Ilfov
 Tel.: +40-(0)31 421 85 68 | Email: info-RO@wago.com



Aveți întrebări despre produsele noastre?
 Vă stăm la dispoziție pentru preluarea apelului la +40 (0) 31 421 85 68.

Customs tariff number

85366990990

Aprobări / certificate



Country specific Approvals

Emblemă	Aprobare	Text de aprobare suplimentar	Nume certificat
	CCA DEKRA Certification B.V.	EN 60947	NTR NL-7626
	CCA DEKRA Certification B.V.	EN 61984	2190419.02
	CSA DEKRA Certification B.V.	C22.2 No. 158	1101144
	KEMA/KEUR DEKRA Certification B.V.	EN 60947	2190419.01

Ship Approvals

Emblemă	Aprobare	Text de aprobare suplimentar	Nume certificat
	DNV GL Det Norske Veritas, Germanischer Lloyd	-	TAE00001V2

UL-Approvals

Emblemă	Aprobare	Text de aprobare suplimentar	Nume certificat
	UR Underwriters Laboratories Inc.	UL 1977	20151210-E45171
	UR Underwriters Laboratories Inc.	UL 1059	20190731-E45172

Supus modificărilor.

WAGO Kontakttechnik GmbH & Co. KG
/Representative Office Romania
Sos. Pipera-Tunari nr. 1/1
building 1, 2nd floor | 077190 Voluntari, Ilfov
Tel.: +40-(0)31 421 85 68 | Email: info-RO@wago.com

Aveți întrebări despre produsele noastre?
Vă stăm la dispoziție pentru preluarea apelului la +40 (0) 31 421 85 68.

Counterpart

Produse compatibile

Coding

**Nr. articol: 769-435**















Coding pin; for coding of female plugs; for carrier terminal blocks / male connectors; orange

www.wago.com/769-435















Female plug

**Nr. articol: 769-101**1-conductor female plug; 4 mm²; 1-pole; 4,00 mm²; graywww.wago.com/769-101**Nr. articol: 769-102**1-conductor female plug; 4 mm²; 2-pole; 4,00 mm²; graywww.wago.com/769-102**Nr. articol: 769-102/000-036**1-conductor female plug; 4 mm²; 2-pole; 4,00 mm²; gray, green-yellowwww.wago.com/769-102/000-036**Nr. articol: 769-102/000-037**1-conductor female plug; 4 mm²; 2-pole; 4,00 mm²; green-yellow, graywww.wago.com/769-102/000-037**Nr. articol: 769-103**1-conductor female plug; 4 mm²; 3-pole; 4,00 mm²; graywww.wago.com/769-103**Nr. articol: 769-103/000-036**1-conductor female plug; 4 mm²; 3-pole; 4,00 mm²; gray, green-yellowwww.wago.com/769-103/000-036**Nr. articol: 769-103/000-037**1-conductor female plug; 4 mm²; 3-pole; 4,00 mm²; green-yellow, graywww.wago.com/769-103/000-037**Nr. articol: 769-103/000-038**1-conductor female plug; 4 mm²; 3-pole; 4,00 mm²; gray, blue, green-yellowwww.wago.com/769-103/000-038**Nr. articol: 769-103/000-039**1-conductor female plug; 4 mm²; 3-pole; 4,00 mm²; green-yellow, blue, graywww.wago.com/769-103/000-039**Nr. articol: 769-104**1-conductor female plug; 4 mm²; 4-pole; 4,00 mm²; graywww.wago.com/769-104**Nr. articol: 769-104/000-036**1-conductor female plug; 4 mm²; 4-pole; 4,00 mm²; gray, green-yellowwww.wago.com/769-104/000-036

Supus modificărilor.

	Nr. articol: 769-104/000-037 1-conductor female plug; 4 mm ² ; 4-pole; 4,00 mm ² ; green-yellow, gray	www.wago.com/769-104/000-037
	Nr. articol: 769-104/000-038 1-conductor female plug; 4 mm ² ; 4-pole; 4,00 mm ² ; gray, blue, green-yellow	www.wago.com/769-104/000-038
	Nr. articol: 769-104/000-039 1-conductor female plug; 4 mm ² ; 4-pole; 4,00 mm ² ; green-yellow, blue, gray	www.wago.com/769-104/000-039
	Nr. articol: 769-105 1-conductor female plug; 4 mm ² ; 5-pole; 4,00 mm ² ; gray	www.wago.com/769-105
	Nr. articol: 769-105/000-036 1-conductor female plug; 4 mm ² ; 5-pole; 4,00 mm ² ; gray, green-yellow	www.wago.com/769-105/000-036
	Nr. articol: 769-105/000-037 1-conductor female plug; 4 mm ² ; 5-pole; 4,00 mm ² ; green-yellow, gray	www.wago.com/769-105/000-037
	Nr. articol: 769-105/000-038 1-conductor female plug; 4 mm ² ; 5-pole; 4,00 mm ² ; gray, blue, green-yellow	www.wago.com/769-105/000-038
	Nr. articol: 769-105/000-039 1-conductor female plug; 4 mm ² ; 5-pole; 4,00 mm ² ; green-yellow, blue, gray	www.wago.com/769-105/000-039
	Nr. articol: 769-106 1-conductor female plug; 4 mm ² ; 6-pole; 4,00 mm ² ; gray	www.wago.com/769-106
	Nr. articol: 769-106/000-006 1-conductor female plug; 4 mm ² ; 6-pole; 4,00 mm ² ; blue	www.wago.com/769-106/000-006
	Nr. articol: 769-106/000-036 1-conductor female plug; 4 mm ² ; 6-pole; 4,00 mm ² ; gray, green-yellow	www.wago.com/769-106/000-036
	Nr. articol: 769-106/000-037 1-conductor female plug; 4 mm ² ; 6-pole; 4,00 mm ² ; green-yellow, gray	www.wago.com/769-106/000-037
	Nr. articol: 769-106/000-038 1-conductor female plug; 4 mm ² ; 6-pole; 4,00 mm ² ; gray, blue, green-yellow	www.wago.com/769-106/000-038
	Nr. articol: 769-106/000-039 1-conductor female plug; 4 mm ² ; 6-pole; 4,00 mm ² ; green-yellow, blue, gray	www.wago.com/769-106/000-039

Supus modificărilor.

	Nr. articol: 769-107 1-conductor female plug; 4 mm ² ; 7-pole; 4,00 mm ² ; gray	www.wago.com/769-107
	Nr. articol: 769-107/000-036 1-conductor female plug; 4 mm ² ; 7-pole; 4,00 mm ² ; gray, green-yellow	www.wago.com/769-107/000-036
	Nr. articol: 769-107/000-037 1-conductor female plug; 4 mm ² ; 7-pole; 4,00 mm ² ; green-yellow, gray	www.wago.com/769-107/000-037
	Nr. articol: 769-107/000-038 1-conductor female plug; 4 mm ² ; 7-pole; 4,00 mm ² ; gray, blue, green-yellow	www.wago.com/769-107/000-038
	Nr. articol: 769-107/000-039 1-conductor female plug; 4 mm ² ; 7-pole; 4,00 mm ² ; green-yellow, blue, gray	www.wago.com/769-107/000-039
	Nr. articol: 769-108 1-conductor female plug; 4 mm ² ; 8-pole; 4,00 mm ² ; gray	www.wago.com/769-108
	Nr. articol: 769-108/000-036 1-conductor female plug; 4 mm ² ; 8-pole; 4,00 mm ² ; gray, green-yellow	www.wago.com/769-108/000-036
	Nr. articol: 769-108/000-037 1-conductor female plug; 4 mm ² ; 8-pole; 4,00 mm ² ; green-yellow, gray	www.wago.com/769-108/000-037
	Nr. articol: 769-108/000-038 1-conductor female plug; 4 mm ² ; 8-pole; 4,00 mm ² ; gray, blue, green-yellow	www.wago.com/769-108/000-038
	Nr. articol: 769-108/000-039 1-conductor female plug; 4 mm ² ; 8-pole; 4,00 mm ² ; green-yellow, blue, gray	www.wago.com/769-108/000-039
	Nr. articol: 769-108/021-000 1-conductor female plug; Locking lever; 4 mm ² ; 8-pole; 4,00 mm ² ; gray	www.wago.com/769-108/021-000
	Nr. articol: 769-121 2-conductor female connector; 4 mm ² ; 1-pole; 4,00 mm ² ; gray	www.wago.com/769-121
	Nr. articol: 769-122 2-conductor female connector; 4 mm ² ; 2-pole; 4,00 mm ² ; gray	www.wago.com/769-122
	Nr. articol: 769-123 2-conductor female connector; 4 mm ² ; 3-pole; 4,00 mm ² ; gray	www.wago.com/769-123
	Nr. articol: 769-124 2-conductor female connector; 4 mm ² ; 4-pole; 4,00 mm ² ; gray	www.wago.com/769-124

Supus modificărilor.

WAGO Kontakttechnik GmbH & Co. KG
/Representative Office Romania
Sos. Pipera-Tunari nr. 1/1
building 1, 2nd floor | 077190 Voluntari, Ilfov
Tel.: +40-(0)31 421 85 68 | Email: info-RO@wago.com

Aveți întrebări despre produsele noastre?
Vă stăm la dispoziție pentru preluarea apelului la +40 (0) 31 421 85 68.



Nr. articol: 769-125
2-conductor female connector; 4 mm²; 5-pole; 4,00 mm²; gray

www.wago.com/769-125



Nr. articol: 769-126
2-conductor female connector; 4 mm²; 6-pole; 4,00 mm²; gray

www.wago.com/769-126



Nr. articol: 769-127
2-conductor female connector; 4 mm²; 7-pole; 4,00 mm²; gray

www.wago.com/769-127



Nr. articol: 769-128
2-conductor female connector; 4 mm²; 8-pole; 4,00 mm²; gray

www.wago.com/769-128

Marking accessories



Nr. articol: 210-831
Marking strips; on reel; 2.3 mm wide; plain; Self-adhesive; white

www.wago.com/210-831



Nr. articol: 210-832
Marking strips; on reel; 3 mm wide; plain; Self-adhesive; white

www.wago.com/210-832



Nr. articol: 210-833
Marking strips; on reel; 6 mm wide; plain; Self-adhesive; white

www.wago.com/210-833



Nr. articol: 210-834
Marking strips; on reel; 5 mm wide; plain; Self-adhesive; white

www.wago.com/210-834

Descărcări

Documentation

Additional Information

Technical explanations

Apr 3, 2019

pdf
2,1 MB

Descărcare

CAD/CAE-Data

CAD data

2D/3D Models 769-638/004-000

URL

Descărcare

PCB Design

Symbol and Footprint 769-638/004-000

URL

Descărcare

CAX data for your PCB design, consisting of "schematic symbols and PCB footprints", allow easy integration of the WAGO component into your development environment.

Supported formats:

- Accel EDA 14 & 15
- Altium 6 to current version

Supus modificărilor.

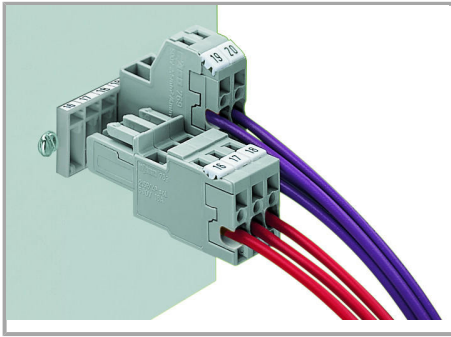

Male header with straight or angled solder pins and feedthrough flanges

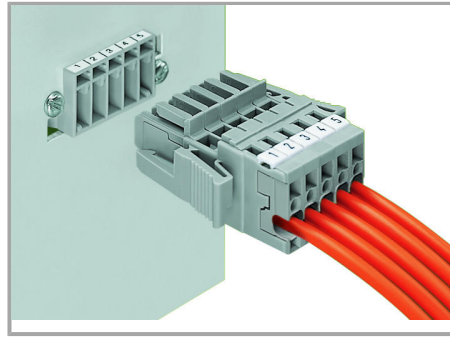

Male header and 1-conductor female plug with lateral locking levers

1-conductor female plug

2-conductor female plug

Familie de produse

X-COM

[Afișare globală produse din familie.](#)

Supus modificărilor.