

Fișă tehnică | Număr articol: 769-667

THT male header; 1.0 x 1.0 mm solder pin; angled; Pin spacing 5 mm; 7-pole;
gray



www.wago.com/769-667



RoHS Compliant

BOMcheck.net

Culoare: ■

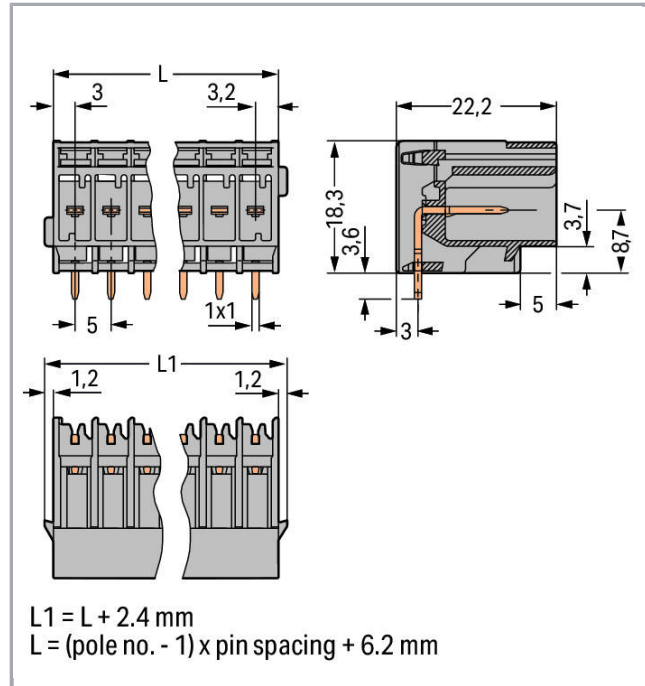

Date

Electrical data

Ratings per IEC/EN 60664-1

Nominal voltage (III/3)	250 V
Rated surge voltage (III/3)	4 kV
Rated voltage (III/2)	500 V
Rated surge voltage (III/2)	4 kV
Rated current	32 A
Legend (ratings)	(III / 3) ≙ Overvoltage category III / Pollution degree 3

Supus modificărilor.

WAGO Kontakttechnik GmbH & Co. KG
/Representative Office Romania
Sos. Pipera-Tunari nr. 1/1
building 1, 2nd floor | 077190 Voluntari, Ilfov
Tel.: +40-(0)31 421 85 68 | Email: info-RO@wago.com

Aveți întrebări despre produsele noastre?
Vă stăm la dispoziție pentru preluarea apelului la +40 (0) 31 421 85 68.



Connection data

Pole No.	7
Total number of potentials	7
Number of levels	1

Geometrical Data

Pin spacing	5 mm / 0.197 inch
Width	38,6 mm / 1.52 inch
Height from the surface	18,3 mm / 0.72 inch
Depth	22,2 mm / 0.874 inch

Plug connection

Contact type (pluggable connector)	Male connector/plug
Connector (connection type)	for PCB
Mismating protection	No
Mating direction to the PCB	0°

PCB contact

PCB contact	THT
-------------	-----

Material Data

Color	gray
Insulation material	Polyamide 66 (PA 66)
Fire load	0,158 MJ
Weight	7,8 g

Commercial data

Product Group	18 (X-COM-System)
Packaging type	BOX
Country of origin	PL
GTIN	4044918760416
Customs tariff number	85366990990

Supus modificărilor.

WAGO Kontakttechnik GmbH & Co. KG
 /Representative Office Romania
 Sos. Pipera-Tunari nr. 1/1
 building 1, 2nd floor | 077190 Voluntari, Ilfov
 Tel.: +40-(0)31 421 85 68 | Email: info-RO@wago.com

Aveți întrebări despre produsele noastre?
 Vă stăm la dispoziție pentru preluarea apelului la +40 (0) 31 421 85 68.

Aprobări / certificate



Country specific Approvals

Emblemă	Aprobare	Text de aprobare suplimentar	Nume certificat
	CCA DEKRA Certification B.V.	EN 60947	NTR NL-7626
	CCA DEKRA Certification B.V.	EN 61984	2190419.02
	CSA DEKRA Certification B.V.	C22.2 No. 158	1101144
	KEMA/KEUR DEKRA Certification B.V.	EN 60947	2190419.01

Ship Approvals

Emblemă	Aprobare	Text de aprobare suplimentar	Nume certificat
	DNV GL Det Norske Veritas, Germanischer Lloyd	-	TAE00001V2

UL-Approvals





Emblemă	Aprobare	Text de aprobare suplimentar	Nume certificat
	UR Underwriters Laboratories Inc.	UL 1977	20151210-E45171
	UR Underwriters Laboratories Inc.	UL 1059	20190731-E45172

Supus modificărilor.









Counterpart

Produse compatibile

Marking accessories

	Nr. articol: 210-831 Marking strips; on reel; 2.3 mm wide; plain; Self-adhesive; white	www.wago.com/210-831
	Nr. articol: 210-832 Marking strips; on reel; 3 mm wide; plain; Self-adhesive; white	www.wago.com/210-832
	Nr. articol: 210-833 Marking strips; on reel; 6 mm wide; plain; Self-adhesive; white	www.wago.com/210-833
	Nr. articol: 210-834 Marking strips; on reel; 5 mm wide; plain; Self-adhesive; white	www.wago.com/210-834

ferrule

	Nr. articol: 216-101 Ferrule; Sleeve for 0.5 mm ² / AWG 22; uninsulated; electro-tin plated	www.wago.com/216-101
	Nr. articol: 216-102 Ferrule; Sleeve for 0.75 mm ² / AWG 20; uninsulated; electro-tin plated	www.wago.com/216-102
	Nr. articol: 216-103 Ferrule; Sleeve for 1 mm ² / AWG 18; uninsulated; electro-tin plated	www.wago.com/216-103
	Nr. articol: 216-104 Ferrule; Sleeve for 1.5 mm ² / AWG 16; uninsulated; electro-tin plated	www.wago.com/216-104
	Nr. articol: 216-201 Ferrule; Sleeve for 0.5 mm ² / 20 AWG; insulated; electro-tin plated; white	www.wago.com/216-201
	Nr. articol: 216-202 Ferrule; Sleeve for 0.75 mm ² / 18 AWG; insulated; electro-tin plated; gray	www.wago.com/216-202
	Nr. articol: 216-203 Ferrule; Sleeve for 1 mm ² / AWG 18; insulated; electro-tin plated; red	www.wago.com/216-203
	Nr. articol: 216-204 Ferrule; Sleeve for 1.5 mm ² / AWG 16; insulated; electro-tin plated; black	www.wago.com/216-204
	Nr. articol: 216-206 Ferrule; Sleeve for 2.5 mm ² / AWG 14; insulated; electro-tin plated; blue	www.wago.com/216-206
	Nr. articol: 216-301 Ferrule; Sleeve for 0.25 mm ² / AWG 24; insulated; electro-tin plated; yellow	www.wago.com/216-301

Supus modificărilor.



Nr. articol: 216-302

Ferrule; Sleeve for 0.34 mm² / 22 AWG; insulated; electro-tin plated; greenwww.wago.com/216-302

Coding



Nr. articol: 769-435

Coding pin; for coding of female plugs; for carrier terminal blocks / male connectors; orange

www.wago.com/769-435

Female plug



Nr. articol: 769-101

1-conductor female plug; 4 mm²; 1-pole; 4,00 mm²; graywww.wago.com/769-101

Nr. articol: 769-102

1-conductor female plug; 4 mm²; 2-pole; 4,00 mm²; graywww.wago.com/769-102

Nr. articol: 769-102/000-036

1-conductor female plug; 4 mm²; 2-pole; 4,00 mm²; gray, green-yellowwww.wago.com/769-102/000-036

Nr. articol: 769-102/000-037

1-conductor female plug; 4 mm²; 2-pole; 4,00 mm²; green-yellow, graywww.wago.com/769-102/000-037

Nr. articol: 769-103

1-conductor female plug; 4 mm²; 3-pole; 4,00 mm²; graywww.wago.com/769-103

Nr. articol: 769-103/000-036

1-conductor female plug; 4 mm²; 3-pole; 4,00 mm²; gray, green-yellowwww.wago.com/769-103/000-036

Nr. articol: 769-103/000-037

1-conductor female plug; 4 mm²; 3-pole; 4,00 mm²; green-yellow, graywww.wago.com/769-103/000-037

Nr. articol: 769-103/000-038

1-conductor female plug; 4 mm²; 3-pole; 4,00 mm²; gray, blue, green-yellowwww.wago.com/769-103/000-038

Nr. articol: 769-103/000-039

1-conductor female plug; 4 mm²; 3-pole; 4,00 mm²; green-yellow, blue, graywww.wago.com/769-103/000-039

Nr. articol: 769-104

1-conductor female plug; 4 mm²; 4-pole; 4,00 mm²; graywww.wago.com/769-104

Nr. articol: 769-104/000-036

1-conductor female plug; 4 mm²; 4-pole; 4,00 mm²; gray, green-yellowwww.wago.com/769-104/000-036

Nr. articol: 769-104/000-037

1-conductor female plug; 4 mm²; 4-pole; 4,00 mm²; green-yellow, graywww.wago.com/769-104/000-037

Supus modificărilor.

WAGO Kontakttechnik GmbH & Co. KG
 /Representative Office Romania
 Sos. Pipera-Tunari nr. 1/1
 building 1, 2nd floor | 077190 Voluntari, Ilfov
 Tel.: +40-(0)31 421 85 68 | Email: info-RO@wago.com

Aveți întrebări despre produsele noastre?
 Vă stăm la dispoziție pentru preluarea apelului la +40 (0) 31 421 85 68.



Nr. articol: 769-104/000-038

1-conductor female plug; 4 mm²; 4-pole; 4,00 mm²; gray, blue, green-yellow

www.wago.com/769-104/000-038



Nr. articol: 769-104/000-039

1-conductor female plug; 4 mm²; 4-pole; 4,00 mm²; green-yellow, blue, gray

www.wago.com/769-104/000-039



Nr. articol: 769-105

1-conductor female plug; 4 mm²; 5-pole; 4,00 mm²; gray

www.wago.com/769-105



Nr. articol: 769-105/000-036

1-conductor female plug; 4 mm²; 5-pole; 4,00 mm²; gray, green-yellow

www.wago.com/769-105/000-036



Nr. articol: 769-105/000-037

1-conductor female plug; 4 mm²; 5-pole; 4,00 mm²; green-yellow, gray

www.wago.com/769-105/000-037



Nr. articol: 769-105/000-038

1-conductor female plug; 4 mm²; 5-pole; 4,00 mm²; gray, blue, green-yellow

www.wago.com/769-105/000-038



Nr. articol: 769-105/000-039

1-conductor female plug; 4 mm²; 5-pole; 4,00 mm²; green-yellow, blue, gray

www.wago.com/769-105/000-039



Nr. articol: 769-106

1-conductor female plug; 4 mm²; 6-pole; 4,00 mm²; gray

www.wago.com/769-106



Nr. articol: 769-106/000-006

1-conductor female plug; 4 mm²; 6-pole; 4,00 mm²; blue

www.wago.com/769-106/000-006



Nr. articol: 769-106/000-036

1-conductor female plug; 4 mm²; 6-pole; 4,00 mm²; gray, green-yellow

www.wago.com/769-106/000-036



Nr. articol: 769-106/000-037

1-conductor female plug; 4 mm²; 6-pole; 4,00 mm²; green-yellow, gray

www.wago.com/769-106/000-037



Nr. articol: 769-106/000-038

1-conductor female plug; 4 mm²; 6-pole; 4,00 mm²; gray, blue, green-yellow

www.wago.com/769-106/000-038



Nr. articol: 769-106/000-039

1-conductor female plug; 4 mm²; 6-pole; 4,00 mm²; green-yellow, blue, gray

www.wago.com/769-106/000-039



Nr. articol: 769-107

1-conductor female plug; 4 mm²; 7-pole; 4,00 mm²; gray

www.wago.com/769-107

Supus modificărilor.



Nr. articol: 769-107/000-036

1-conductor female plug; 4 mm²; 7-pole; 4,00 mm²; gray, green-yellow

www.wago.com/769-107/000-036



Nr. articol: 769-107/000-037

1-conductor female plug; 4 mm²; 7-pole; 4,00 mm²; green-yellow, gray

www.wago.com/769-107/000-037



Nr. articol: 769-107/000-038

1-conductor female plug; 4 mm²; 7-pole; 4,00 mm²; gray, blue, green-yellow

www.wago.com/769-107/000-038



Nr. articol: 769-107/000-039

1-conductor female plug; 4 mm²; 7-pole; 4,00 mm²; green-yellow, blue, gray

www.wago.com/769-107/000-039



Nr. articol: 769-107/021-000

1-conductor female plug; Locking lever; 4 mm²; 7-pole; 4,00 mm²; gray

www.wago.com/769-107/021-000



Nr. articol: 769-108

1-conductor female plug; 4 mm²; 8-pole; 4,00 mm²; gray

www.wago.com/769-108



Nr. articol: 769-108/000-036

1-conductor female plug; 4 mm²; 8-pole; 4,00 mm²; gray, green-yellow

www.wago.com/769-108/000-036



Nr. articol: 769-108/000-037

1-conductor female plug; 4 mm²; 8-pole; 4,00 mm²; green-yellow, gray

www.wago.com/769-108/000-037



Nr. articol: 769-108/000-038

1-conductor female plug; 4 mm²; 8-pole; 4,00 mm²; gray, blue, green-yellow

www.wago.com/769-108/000-038



Nr. articol: 769-108/000-039

1-conductor female plug; 4 mm²; 8-pole; 4,00 mm²; green-yellow, blue, gray

www.wago.com/769-108/000-039



Nr. articol: 769-109

1-conductor female plug; 4 mm²; 9-pole; 4,00 mm²; gray

www.wago.com/769-109



Nr. articol: 769-109/000-036

1-conductor female plug; 4 mm²; 9-pole; 4,00 mm²; gray, green-yellow

www.wago.com/769-109/000-036



Nr. articol: 769-109/000-037

1-conductor female plug; 4 mm²; 9-pole; 4,00 mm²; green-yellow, gray

www.wago.com/769-109/000-037



Nr. articol: 769-109/000-038

1-conductor female plug; 4 mm²; 9-pole; 4,00 mm²; gray, blue, green-yellow

www.wago.com/769-109/000-038

Supus modificărilor.



Nr. articol: 769-109/000-039

1-conductor female plug; 4 mm²; 9-pole; 4,00 mm²; green-yellow, blue, gray

www.wago.com/769-109/000-039



Nr. articol: 769-110

1-conductor female plug; 4 mm²; 10-pole; 4,00 mm²; gray

www.wago.com/769-110



Nr. articol: 769-110/000-036

1-conductor female plug; 4 mm²; 10-pole; 4,00 mm²; gray, green-yellow

www.wago.com/769-110/000-036



Nr. articol: 769-110/000-037

1-conductor female plug; 4 mm²; 10-pole; 4,00 mm²; green-yellow, gray

www.wago.com/769-110/000-037



Nr. articol: 769-110/000-038

1-conductor female plug; 4 mm²; 10-pole; 4,00 mm²; gray, blue, green-yellow

www.wago.com/769-110/000-038



Nr. articol: 769-110/000-039

1-conductor female plug; 4 mm²; 10-pole; 4,00 mm²; green-yellow, blue, gray

www.wago.com/769-110/000-039



Nr. articol: 769-111

1-conductor female plug; 4 mm²; 11-pole; 4,00 mm²; gray

www.wago.com/769-111



Nr. articol: 769-111/000-036

1-conductor female plug; 4 mm²; 11-pole; 4,00 mm²; gray, green-yellow

www.wago.com/769-111/000-036



Nr. articol: 769-111/000-037

1-conductor female plug; 4 mm²; 11-pole; 4,00 mm²; green-yellow, gray

www.wago.com/769-111/000-037



Nr. articol: 769-111/000-038

1-conductor female plug; 4 mm²; 11-pole; 4,00 mm²; gray, blue, green-yellow

www.wago.com/769-111/000-038



Nr. articol: 769-111/000-039

1-conductor female plug; 4 mm²; 11-pole; 4,00 mm²; green-yellow, blue, gray

www.wago.com/769-111/000-039



Nr. articol: 769-112

1-conductor female plug; 4 mm²; 12-pole; 4,00 mm²; gray

www.wago.com/769-112



Nr. articol: 769-112/000-036

1-conductor female plug; 4 mm²; 12-pole; 4,00 mm²; gray, green-yellow

www.wago.com/769-112/000-036



Nr. articol: 769-112/000-037

1-conductor female plug; 4 mm²; 12-pole; 4,00 mm²; green-yellow, gray

www.wago.com/769-112/000-037

Supus modificărilor.



Nr. articol: 769-112/000-038

1-conductor female plug; 4 mm²; 12-pole; 4,00 mm²; gray, blue, green-yellow

www.wago.com/769-112/000-038



Nr. articol: 769-112/000-039

1-conductor female plug; 4 mm²; 12-pole; 4,00 mm²; green-yellow, blue, gray

www.wago.com/769-112/000-039



Nr. articol: 769-113

1-conductor female plug; 4 mm²; 13-pole; 4,00 mm²; gray

www.wago.com/769-113



Nr. articol: 769-113/000-036

1-conductor female plug; 4 mm²; 13-pole; 4,00 mm²; gray, green-yellow

www.wago.com/769-113/000-036



Nr. articol: 769-113/000-037

1-conductor female plug; 4 mm²; 13-pole; 4,00 mm²; green-yellow, gray

www.wago.com/769-113/000-037



Nr. articol: 769-113/000-038

1-conductor female plug; 4 mm²; 13-pole; 4,00 mm²; gray, blue, green-yellow

www.wago.com/769-113/000-038



Nr. articol: 769-113/000-039

1-conductor female plug; 4 mm²; 13-pole; 4,00 mm²; green-yellow, blue, gray

www.wago.com/769-113/000-039



Nr. articol: 769-114

1-conductor female plug; 4 mm²; 14-pole; 4,00 mm²; gray

www.wago.com/769-114



Nr. articol: 769-114/000-036

1-conductor female plug; 4 mm²; 14-pole; 4,00 mm²; gray, green-yellow

www.wago.com/769-114/000-036



Nr. articol: 769-114/000-037

1-conductor female plug; 4 mm²; 14-pole; 4,00 mm²; green-yellow, gray

www.wago.com/769-114/000-037



Nr. articol: 769-114/000-038

1-conductor female plug; 4 mm²; 14-pole; 4,00 mm²; gray, blue, green-yellow

www.wago.com/769-114/000-038



Nr. articol: 769-114/000-039

1-conductor female plug; 4 mm²; 14-pole; 4,00 mm²; green-yellow, blue, gray

www.wago.com/769-114/000-039



Nr. articol: 769-115

1-conductor female plug; 4 mm²; 15-pole; 4,00 mm²; gray

www.wago.com/769-115



















Nr. articol: 769-115/000-036

1-conductor female plug; 4 mm²; 15-pole; 4,00 mm²; gray, green-yellow

www.wago.com/769-115/000-036

Supus modificărilor.

	Nr. articol: 769-115/000-037 1-conductor female plug; 4 mm ² ; 15-pole; 4,00 mm ² ; green-yellow, gray	www.wago.com/769-115/000-037
	Nr. articol: 769-115/000-038 1-conductor female plug; 4 mm ² ; 15-pole; 4,00 mm ² ; gray, blue, green-yellow	www.wago.com/769-115/000-038
	Nr. articol: 769-115/000-039 1-conductor female plug; 4 mm ² ; 15-pole; 4,00 mm ² ; green-yellow, blue, gray	www.wago.com/769-115/000-039
	Nr. articol: 769-122 2-conductor female connector; 4 mm ² ; 2-pole; 4,00 mm ² ; gray	www.wago.com/769-122
	Nr. articol: 769-123 2-conductor female connector; 4 mm ² ; 3-pole; 4,00 mm ² ; gray	www.wago.com/769-123
	Nr. articol: 769-124 2-conductor female connector; 4 mm ² ; 4-pole; 4,00 mm ² ; gray	www.wago.com/769-124
	Nr. articol: 769-125 2-conductor female connector; 4 mm ² ; 5-pole; 4,00 mm ² ; gray	www.wago.com/769-125
	Nr. articol: 769-126 2-conductor female connector; 4 mm ² ; 6-pole; 4,00 mm ² ; gray	www.wago.com/769-126
	Nr. articol: 769-127 2-conductor female connector; 4 mm ² ; 7-pole; 4,00 mm ² ; gray	www.wago.com/769-127
	Nr. articol: 769-128 2-conductor female connector; 4 mm ² ; 8-pole; 4,00 mm ² ; gray	www.wago.com/769-128
	Nr. articol: 769-129 2-conductor female connector; 4 mm ² ; 9-pole; 4,00 mm ² ; gray	www.wago.com/769-129
	Nr. articol: 769-130 2-conductor female connector; 4 mm ² ; 10-pole; 4,00 mm ² ; gray	www.wago.com/769-130
	Nr. articol: 769-131 2-conductor female connector; 4 mm ² ; 11-pole; 4,00 mm ² ; gray	www.wago.com/769-131
	Nr. articol: 769-132 2-conductor female connector; 4 mm ² ; 12-pole; 4,00 mm ² ; gray	www.wago.com/769-132
	Nr. articol: 769-133 2-conductor female connector; 4 mm ² ; 13-pole; 4,00 mm ² ; gray	www.wago.com/769-133
	Nr. articol: 769-134 2-conductor female connector; 4 mm ² ; 14-pole; 4,00 mm ² ; gray	www.wago.com/769-134
	Nr. articol: 769-135 2-conductor female connector; 4 mm ² ; 15-pole; 4,00 mm ² ; gray	www.wago.com/769-135

Supus modificărilor.

WAGO Kontakttechnik GmbH & Co. KG
/Representative Office Romania
Sos. Pipera-Tunari nr. 1/1
building 1, 2nd floor | 077190 Voluntari, Ilfov
Tel.: +40-(0)31 421 85 68 | Email: info-RO@wago.com

Aveți întrebări despre produsele noastre?
Vă stăm la dispoziție pentru preluarea apelului la +40 (0) 31 421 85 68.



Descărcări

Documentation

Additional Information

Technical explanations

Apr 3, 2019

pdf
2,1 MB

Descărcare

CAD/CAE-Data

CAD data

2D/3D Models 769-667

URL

Descărcare

PCB Design

Symbol and Footprint 769-667

URL

Descărcare

CAX data for your PCB design, consisting of "schematic symbols and PCB footprints", allow easy integration of the WAGO component into your development environment.

Supported formats:

- Accel EDA 14 & 15
- Altium 6 to current version
- Cadence Allegro
- DesignSpark
- Eagle Libraries
- KiCad
- Mentor Graphics BoardStation
- Mentor Graphics Design Architect
- Mentor Graphics Design Expedition 99 and 2000
- OrCAD 9.X PCB and Capture
- PADS PowerPCB 3, 3.5, 4.X, and 5.X
- PADS PowerPCB and PowerLogic 3.0
- PCAD 2000, 2001, 2002, 2004, and 2006
- Pulsonix 8.5 or newer
- STL
- 3D STEP
- TARGET 3001!
- View Logic ViewDraw
- Quadcept
- Zuken CadStar 3 and 4

—
Supus modificărilor.

- Zuken CR-5000 and CR-8000

PCB Component Libraries (EDA), PCB CAD Library Ultra Librarian

Installation Notes

Assembly

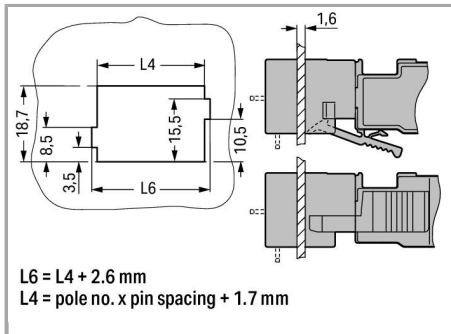

Cutout

Male headers with solder pins

Application

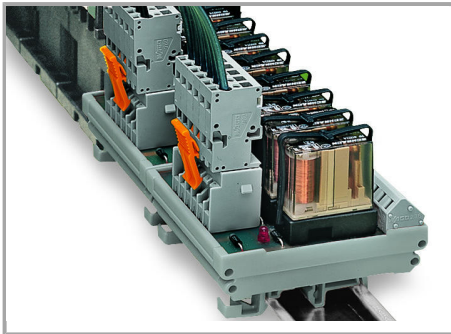

Male headers with straight solder pins and 1-conductor female plugs (picture shows a relay module)

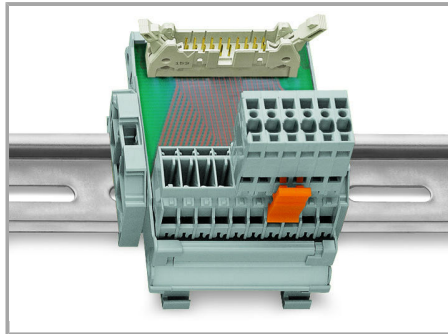

Male headers with solder pins for printed circuit boards

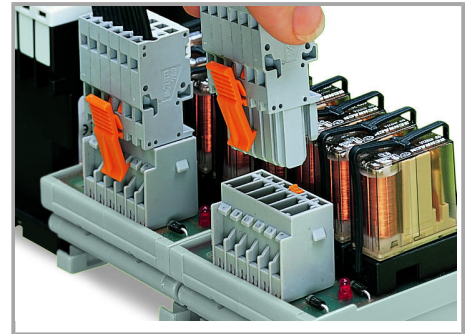

Pluggable PCB connection

Connection to a relay module inside the switchgear cabinet

Supus modificărilor.

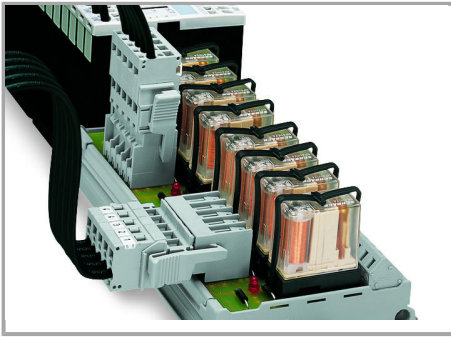

Male headers with solder pins:

Integrating PCB components into the system wiring.

Familie de produse

X-COM

[Afișare globală produse din familie.](#)

Supus modificărilor.