

Fișă tehnică | Număr articol: 722-234/005-000/039-000

Female connector for rail-mount terminal blocks; 0.6 x 1 mm pins; angled;
100% protected against mismatching; Locking lever; Pin spacing 5 mm; 4-pole;
light gray

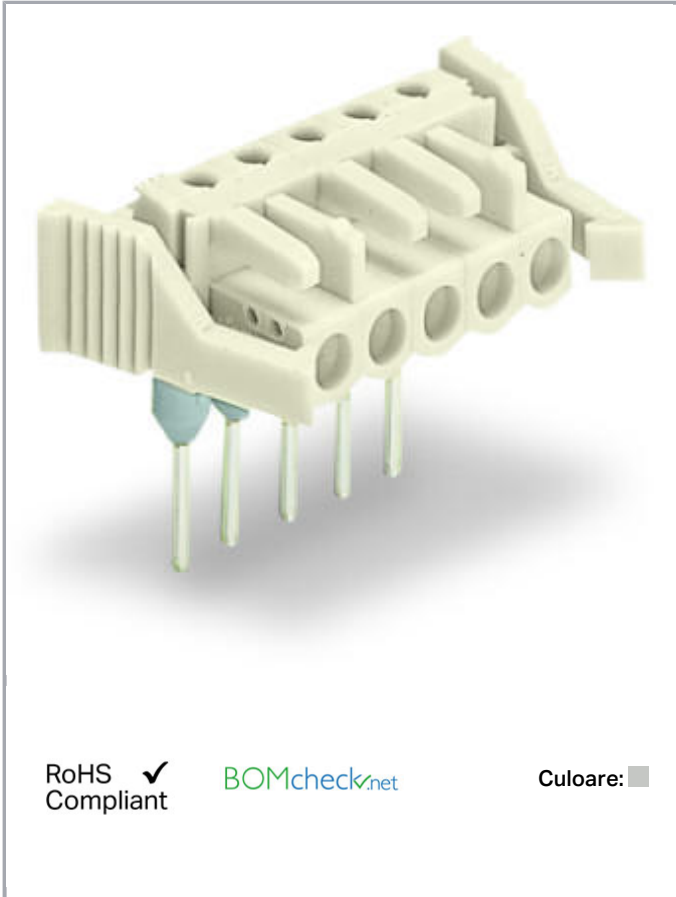

www.wago.com/722-234/005-000/039-000



Supus modificărilor.

WAGO Kontakttechnik GmbH & Co. KG
/Representative Office Romania
Sos. Pipera-Tunari nr. 1/1
building 1, 2nd floor | 077190 Voluntari, Ilfov
Tel.: +40-(0)31 421 85 68 | Email: info-RO@wago.com

Aveți întrebări despre produsele noastre?
Vă stăm la dispoziție pentru preluarea apelului la +40 (0) 31 421 85 68.

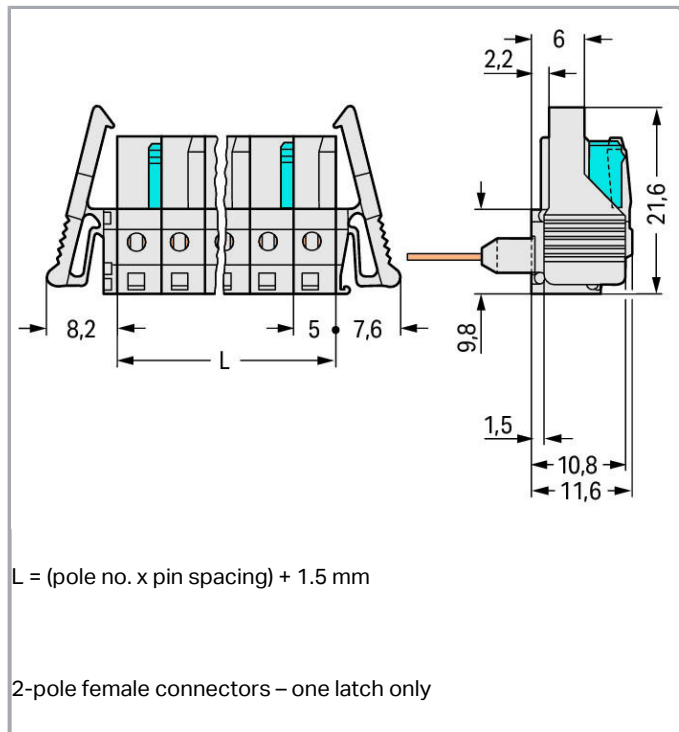

Descriere articol

- Pluggable connectors for rail-mount terminal blocks equipped with CAGE CLAMP® connection
- Female connectors with long contact pins connect to the termination ports of 280 Series Rail-Mount Terminal Blocks
- Female connectors are touch-proof when unmated, providing a pluggable, live output
- 100 % protected against mismatching
- With coding fingers

Safety information 1:

The *MULTI CONNECTION SYSTEM (MCS)* is designed without breaking capacity for compliance with DIN EN 61984. When used as intended, MCS Connectors shall not be connected/disconnected when live or under load. The circuit design should ensure header pins, which can be touched, are not live when unmated.

Date

Electrical data

Ratings per IEC/EN 60664-1

Ratings per	IEC/EN 60664-1
Nominal voltage (III/3)	320 V

Supus modificărilor.

WAGO Kontakttechnik GmbH & Co. KG
 /Representative Office Romania
 Sos. Pipera-Tunari nr. 1/1
 building 1, 2nd floor | 077190 Voluntari, Ilfov
 Tel.: +40-(0)31 421 85 68 | Email: info-RO@wago.com

Aveți întrebări despre produsele noastre?
 Vă stăm la dispoziție pentru preluarea apelului la +40 (0) 31 421 85 68.



Rated surge voltage (III/3)	4 kV
Rated voltage (III/2)	320 V
Rated surge voltage (III/2)	4 kV
Nominal voltage (II/2)	630 V
Rated surge voltage (II/2)	4 kV
Rated current	12 A
Legend (ratings)	(III / 2) $\hat{=}$ Overvoltage category III / Pollution degree 2

Approvals per UL 1059

Rated voltage UL (Use Group B)	300 V
Rated current UL (Use Group B)	15 A
Rated voltage UL (Use Group D)	300 V
Rated current UL (Use Group D)	10 A
Approvals per	UL 1059

Approvals per UL 1977

Rated voltage UL 1977	600 V
Rated current UL 1977	15 A

Approvals per CSA

Rated voltage CSA (Use Group B)	300 V
Rated current CSA (Use Group B)	15 A
Rated voltage CSA (Use Group D)	300 V
Rated current CSA (Use Group D)	10 A

Connection data

Pole No.	4
Total number of potentials	4
Number of connection types	1
Number of levels	1

Geometrical Data

Pin spacing	5 mm / 0.197 inch
Width	35.8 mm / 1.409 inch
Height	26.1 mm / 1.028 inch
Height from the surface	11.6 mm / 0.457 inch

Supus modificărilor.

WAGO Kontakttechnik GmbH & Co. KG
 /Representative Office Romania
 Sos. Pipera-Tunari nr. 1/1
 building 1, 2nd floor | 077190 Voluntari, Ilfov
 Tel.: +40-(0)31 421 85 68 | Email: info-RO@wago.com

Aveți întrebări despre produsele noastre?
 Vă stăm la dispoziție pentru preluarea apelului la +40 (0) 31 421 85 68.

Depth	18.25 mm / 0.719 inch
-------	-----------------------

Plug connection

Contact type (pluggable connector)	Female connector/socket
Connector (connection type)	for front-entry wiring terminal block
Mismatching protection	Yes
Locking of plug-in connection	locking lever
Mating direction to the rail-mount terminal block	0°

Material Data

Color	light gray
Material group	I
Insulation material	Polyamide 66 (PA 66)
Flammability class per UL94	V0
Contact material	Copper alloy
Contact plating	tin-plated
Fire load	0,099 MJ
Weight	5,3 g

Environmental Requirements

Limit temperature range	-60 ... +85 °C
-------------------------	----------------

Commercial data

Product Group	3 (Multi Conn. System)
Packaging type	BOX
Country of origin	DE
GTIN	4044918572453
Customs tariff number	85366990990

Aprobări / certificate

Country specific Approvals



Emblemă	Aprobare	Text de aprobare suplimentar	Nume certificat
	CSA DEKRA Certification B.V.	C22.2	1466354

Supus modificărilor.

Ship Approvals

Emblemă	Aprobare	Text de aprobare suplimentar	Nume certificat
	ABS American Bureau of Shipping	-	19- HG1869876- PDA

UL-Approvals

Emblemă	Aprobare	Text de aprobare suplimentar	Nume certificat
	UL Underwriters Laboratories Inc.	UL 1059	E45172- 19911118
	UR UL International Germany GmbH	UL 1977	E45171

Counterpart





Nr. articol 721-604

1-conductor male connector; 100% protected against mismatching; 2.5 mm²; Pin spacing 5 mm; 4-pole; 2,50 mm²; light graywww.wago.com/721-604

Produse compatibile

General accessories

	Nr. articol: 280-650/056-000 Spacer of same profile; suitable for 3-conductor terminal blocks of horizontal type; orange	www.wago.com/280-650/056-000
	Nr. articol: 280-654/056-000 Spacer of same profile; suitable for 3- and 4-conductor terminal blocks of angled type; orange	www.wago.com/280-654/056-000
	Nr. articol: 280-835/056-000 Spacer of same profile; suitable for 4-conductor terminal blocks of horizontal type; orange	www.wago.com/280-835/056-000

Supus modificărilor.

WAGO Kontakttechnik GmbH & Co. KG
/Representative Office Romania
Sos. Pipera-Tunari nr. 1/1
building 1, 2nd floor | 077190 Voluntari, Ilfov
Tel.: +40-(0)31 421 85 68 | Email: info-RO@wago.com

Aveți întrebări despre produsele noastre?
Vă stăm la dispoziție pentru preluarea apelului la +40 (0) 31 421 85 68.



Nr. articol: 280-902/056-000

Spacer of same profile; suitable for 2-conductor terminal blocks of horizontal type; orange

www.wago.com/280-902/056-000

tools



Nr. articol: 280-434

Operating tool; made of insulating material; 4-way

www.wago.com/280-434

check



Nr. articol: 210-136

Test plug; 2 mm Ø; with 500 mm cable; red

www.wago.com/210-136

Nr. articol: 210-137

Test plug; 2.3 mm Ø; with 500 mm cable; yellow

www.wago.com/210-137

Nr. articol: 231-661

Test plugs for female connectors; for 5 mm and 5.08 mm pin spacing; 2,50 mm²; light gray
www.wago.com/231-661

Descărcări

Documentation

Additional Information

Technical explanations

Apr 3, 2019

pdf
3,6 MB

Descărcare

CAD/CAE-Data

CAD data

2D/3D Models 722-234/005-000/039-000

URL

Descărcare

CAE data

EPLAN Data Portal 722-234/005-000/039-000

URL

Descărcare

Installation Notes

Familie de produse

<i>MCS</i> MIDI

Afișare globală produse din familie.

Supus modificărilor.

WAGO Kontakttechnik GmbH & Co. KG
/Representative Office Romania
Sos. Pipera-Tunari nr. 1/1
building 1, 2nd floor | 077190 Voluntari, Ilfov
Tel.: +40-(0)31 421 85 68 | Email: info-RO@wago.com

Aveți întrebări despre produsele noastre?
Vă stăm la dispoziție pentru preluarea apelului la +40 (0) 31 421 85 68.