

Fișă tehnică | Număr articol: 722-139/005-000/039-000

Female connector for rail-mount terminal blocks; 0.6 x 1 mm pins; straight;
100% protected against mismatching; Locking lever; Pin spacing 5 mm; 9-pole;
light gray

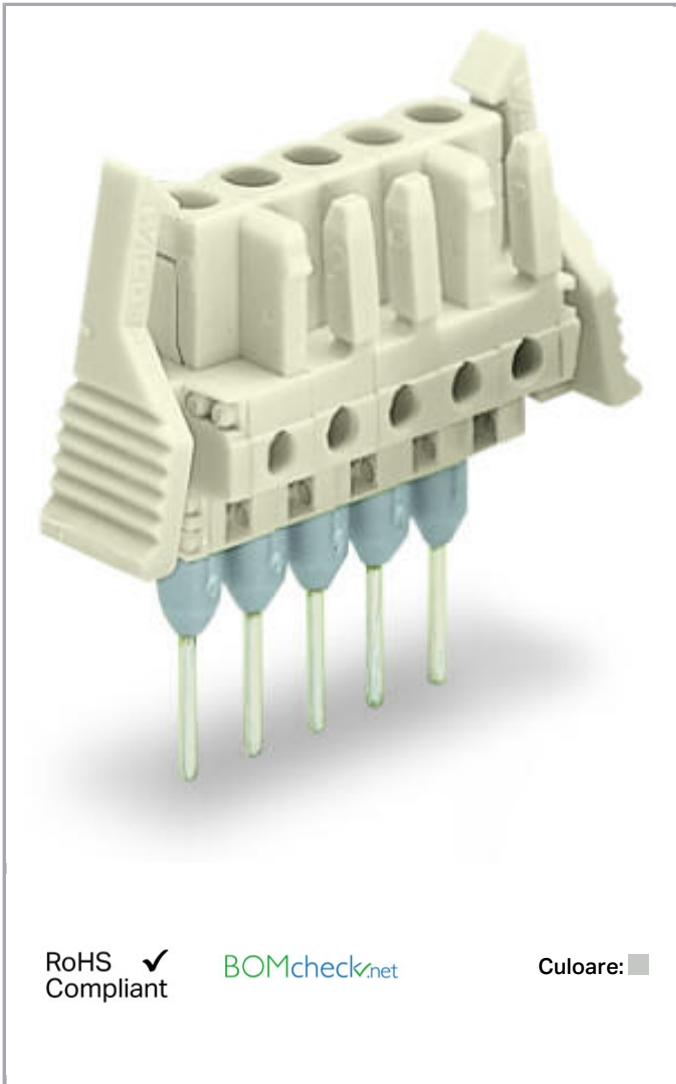

www.wago.com/722-139/005-000/039-000



RoHS Compliant

BOMcheck.net

Culoare: ■

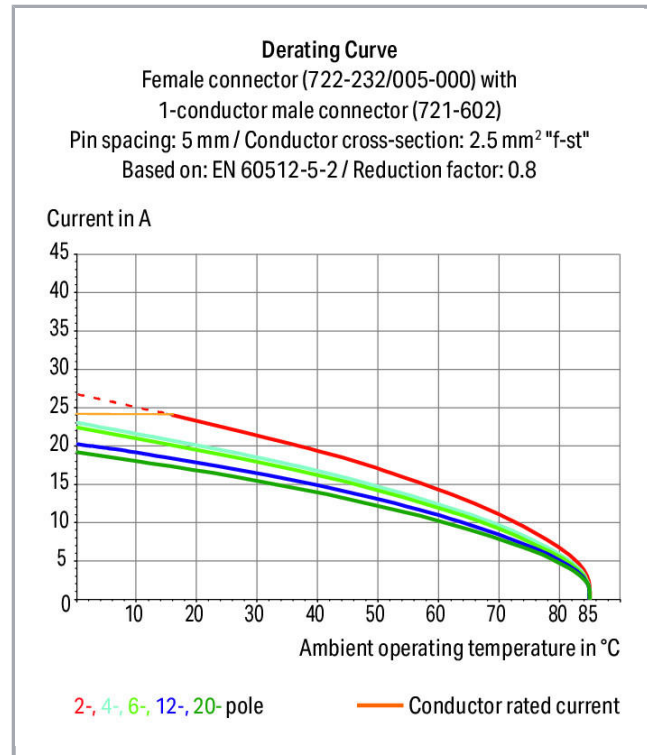

Supus modificărilor.

WAGO Kontakttechnik GmbH & Co. KG
/Representative Office Romania
Sos. Pipera-Tunari nr. 1/1
building 1, 2nd floor | 077190 Voluntari, Ilfov
Tel.: +40-(0)31 421 85 68 | Email: info-RO@wago.com

Aveți întrebări despre produsele noastre?
Vă stăm la dispoziție pentru preluarea apelului la +40 (0) 31 421 85 68.

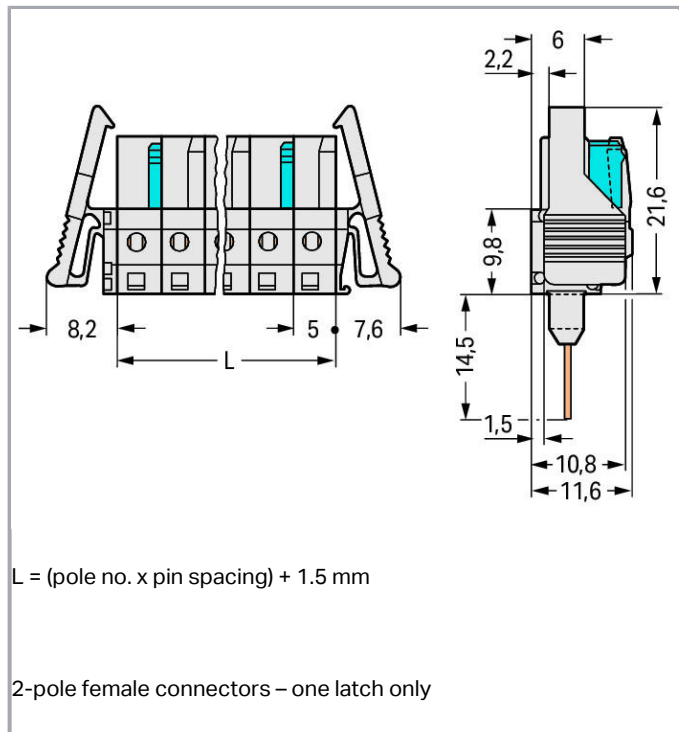

Descriere articol

- Pluggable connectors for rail-mount terminal blocks equipped with CAGE CLAMP® connection
- Female connectors with long contact pins connect to the termination ports of 280 Series Rail-Mount Terminal Blocks
- Female connectors are touch-proof when unmated, providing a pluggable, live output
- 100 % protected against mismatching
- With coding fingers

Safety information 1:

The *MULTI CONNECTION SYSTEM (MCS)* is designed without breaking capacity for compliance with DIN EN 61984. When used as intended, MCS Connectors shall not be connected/disconnected when live or under load. The circuit design should ensure header pins, which can be touched, are not live when unmated.

Date

Electrical data

Ratings per IEC/EN 60664-1

Ratings per	IEC/EN 60664-1
Nominal voltage (III/3)	320 V

Supus modificărilor.

WAGO Kontakttechnik GmbH & Co. KG
 /Representative Office Romania
 Sos. Pipera-Tunari nr. 1/1
 building 1, 2nd floor | 077190 Voluntari, Ilfov
 Tel.: +40-(0)31 421 85 68 | Email: info-RO@wago.com

Aveți întrebări despre produsele noastre?
 Vă stăm la dispoziție pentru preluarea apelului la +40 (0) 31 421 85 68.



Rated surge voltage (III/3)	4 kV
Rated voltage (III/2)	320 V
Rated surge voltage (III/2)	4 kV
Nominal voltage (II/2)	630 V
Rated surge voltage (II/2)	4 kV
Rated current	12 A
Legend (ratings)	(III / 2) $\hat{=}$ Overvoltage category III / Pollution degree 2

Approvals per UL 1059

Rated voltage UL (Use Group B)	300 V
Rated current UL (Use Group B)	15 A
Rated voltage UL (Use Group D)	300 V
Rated current UL (Use Group D)	10 A
Approvals per	UL 1059

Approvals per UL 1977

Rated voltage UL 1977	600 V
Rated current UL 1977	15 A

Approvals per CSA

Rated voltage CSA (Use Group B)	300 V
Rated current CSA (Use Group B)	15 A
Rated voltage CSA (Use Group D)	300 V
Rated current CSA (Use Group D)	10 A

Connection data

Pole No.	9
Total number of potentials	9
Number of connection types	1
Number of levels	1

Geometrical Data

Pin spacing	5 mm / 0.197 inch
Width	60.8 mm / 2.394 inch
Height	36.1 mm / 1.421 inch
Height from the surface	21.6 mm / 0.85 inch

Supus modificărilor.

WAGO Kontakttechnik GmbH & Co. KG
 /Representative Office Romania
 Sos. Pipera-Tunari nr. 1/1
 building 1, 2nd floor | 077190 Voluntari, Ilfov
 Tel.: +40-(0)31 421 85 68 | Email: info-RO@wago.com

Aveți întrebări despre produsele noastre?
 Vă stăm la dispoziție pentru preluarea apelului la +40 (0) 31 421 85 68.

Depth	11.6 mm / 0.457 inch
-------	----------------------

Plug connection

Contact type (pluggable connector)	Female connector/socket
Connector (connection type)	for front-entry wiring terminal block
Mismating protection	Yes
Locking of plug-in connection	locking lever
Mating direction to the rail-mount terminal block	90°

Material Data

Color	light gray
Material group	I
Insulation material	Polyamide 66 (PA 66)
Flammability class per UL94	V0
Contact material	Copper alloy
Contact plating	tin-plated
Fire load	0,185 MJ
Weight	10,4 g

Environmental Requirements

Limit temperature range	-60 ... +85 °C
-------------------------	----------------

Commercial data

Product Group	3 (Multi Conn. System)
Packaging type	BOX
Country of origin	DE
GTIN	4044918571487
Customs tariff number	85366990990

Aprobări / certificate

Country specific Approvals

Emblemă	Aprobare	Text de aprobare suplimentar	Nume certificat
	CSA DEKRA Certification B.V.	C22.2	1466354

Supus modificărilor.



WAGO Kontakttechnik GmbH & Co. KG
/Representative Office Romania
Sos. Pipera-Tunari nr. 1/1
building 1, 2nd floor | 077190 Voluntari, Ilfov
Tel.: +40-(0)31 421 85 68 | Email: info-RO@wago.com

Aveți întrebări despre produsele noastre?
Vă stăm la dispoziție pentru preluarea apelului la +40 (0) 31 421 85 68.

Ship Approvals

Emblemă	Aprobare	Text de aprobare suplimentar	Nume certificat
	ABS American Bureau of Shipping	-	19- HG1869876- PDA

UL-Approvals

Emblemă	Aprobare	Text de aprobare suplimentar	Nume certificat
	UL Underwriters Laboratories Inc.	UL 1059	E45172- 19911118
	UR UL International Germany GmbH	UL 1977	E45171

Counterpart





Nr. articol 721-609

1-conductor male connector; 100% protected against mismatching; 2.5 mm²; Pin spacing 5 mm; 9-pole; 2,50 mm²; light graywww.wago.com/721-609

Produse compatibile

General accessories

	Nr. articol: 280-650/056-000 Spacer of same profile; suitable for 3-conductor terminal blocks of horizontal type; orange	www.wago.com/280-650/056-000
	Nr. articol: 280-654/056-000 Spacer of same profile; suitable for 3- and 4-conductor terminal blocks of angled type; orange	www.wago.com/280-654/056-000
	Nr. articol: 280-835/056-000 Spacer of same profile; suitable for 4-conductor terminal blocks of horizontal type; orange	www.wago.com/280-835/056-000

Supus modificărilor.

WAGO Kontakttechnik GmbH & Co. KG
/Representative Office Romania
Sos. Pipera-Tunari nr. 1/1
building 1, 2nd floor | 077190 Voluntari, Ilfov
Tel.: +40-(0)31 421 85 68 | Email: info-RO@wago.com

Aveți întrebări despre produsele noastre?
Vă stăm la dispoziție pentru preluarea apelului la +40 (0) 31 421 85 68.



Nr. articol: 280-902/056-000

Spacer of same profile; suitable for 2-conductor terminal blocks of horizontal type; orange

www.wago.com/280-902/056-000

check



Nr. articol: 210-136

Test plug; 2 mm Ø; with 500 mm cable; red

www.wago.com/210-136



Nr. articol: 210-137

Test plug; 2.3 mm Ø; with 500 mm cable; yellow

www.wago.com/210-137



Nr. articol: 231-661

Test plugs for female connectors; for 5 mm and 5.08 mm pin spacing; 2,50 mm²; light gray

www.wago.com/231-661

Descărcări

Documentation

Additional Information

Technical explanations	Apr 3, 2019	pdf 3,6 MB	Descărcare
------------------------	-------------	---------------	------------

CAD/CAE-Data

CAD data

2D/3D Models 722-139/005-000/039-000	URL	Descărcare
--------------------------------------	-----	------------

CAE data

EPLAN Data Portal 722-139/005-000/039-000	URL	Descărcare
---	-----	------------

Installation Notes

Familie de produse

<i>MCS</i> MIDI

Afișare globală produse din familie.

Supus modificărilor.