

## Fișă tehnică | Număr articol: 722-136/005-000/039-000

Female connector for rail-mount terminal blocks; 0.6 x 1 mm pins; straight;  
100% protected against mismatching; Locking lever; Pin spacing 5 mm; 6-pole;  
light gray

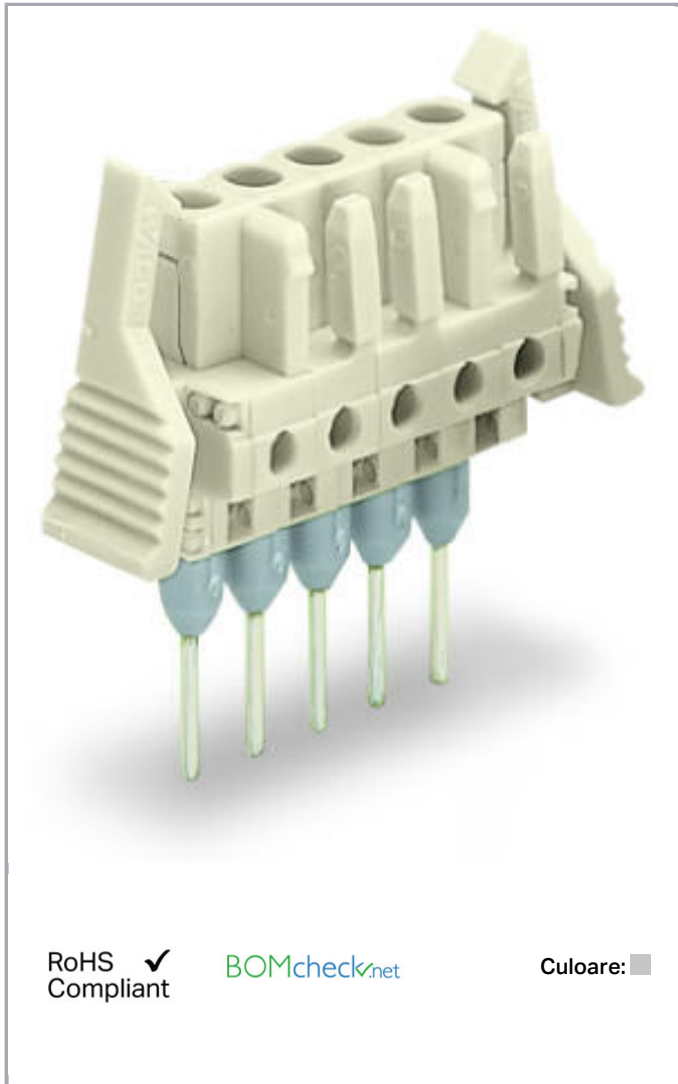

[www.wago.com/722-136/005-000/039-000](http://www.wago.com/722-136/005-000/039-000)



RoHS Compliant

Culoare:

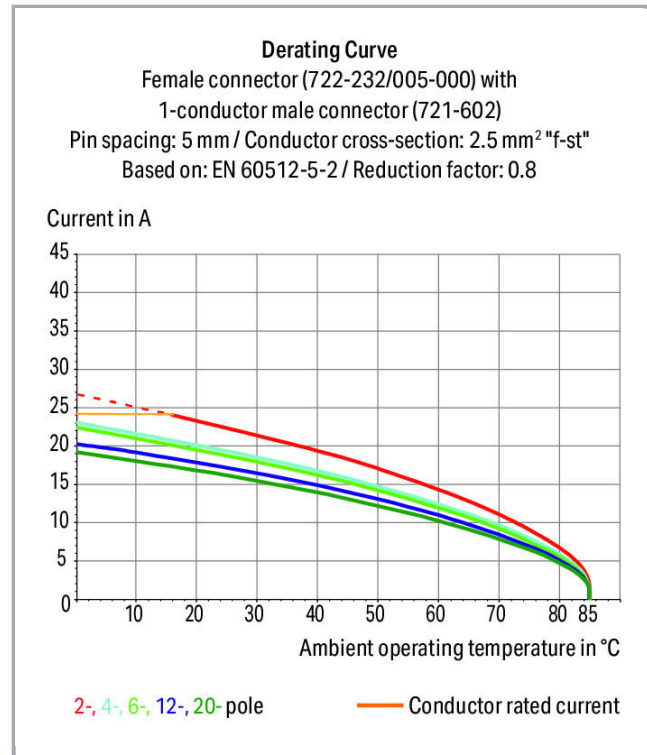

Supus modificărilor.

WAGO Kontakttechnik GmbH & Co. KG  
/Representative Office Romania  
Sos. Pipera-Tunari nr. 1/1  
building 1, 2nd floor | 077190 Voluntari, Ilfov  
Tel.: +40-(0)31 421 85 68 | Email: info-RO@wago.com

Aveți întrebări despre produsele noastre?  
Vă stăm la dispoziție pentru preluarea apelului la +40 (0) 31 421 85 68.

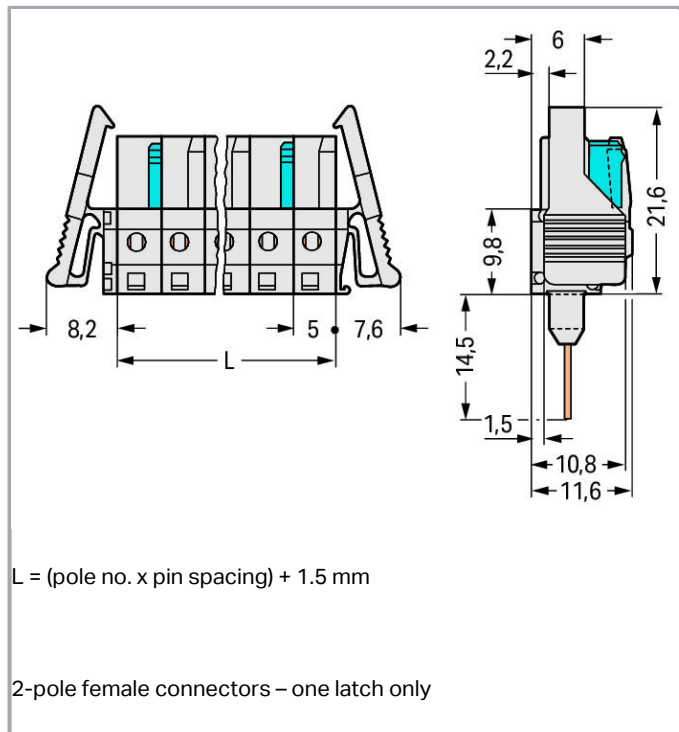

## Descriere articol

- Pluggable connectors for rail-mount terminal blocks equipped with CAGE CLAMP® connection
- Female connectors with long contact pins connect to the termination ports of 280 Series Rail-Mount Terminal Blocks
- Female connectors are touch-proof when unmated, providing a pluggable, live output
- 100 % protected against mismatching
- With coding fingers

### Safety information 1:

The *MULTI CONNECTION SYSTEM (MCS)* is designed without breaking capacity for compliance with DIN EN 61984. When used as intended, MCS Connectors shall not be connected/disconnected when live or under load. The circuit design should ensure header pins, which can be touched, are not live when unmated.

## Date

### Electrical data

### Ratings per IEC/EN 60664-1

| Ratings per             | IEC/EN 60664-1 |
|-------------------------|----------------|
| Nominal voltage (III/3) | 320 V          |

Supus modificărilor.

WAGO Kontakttechnik GmbH & Co. KG  
 /Representative Office Romania  
 Sos. Pipera-Tunari nr. 1/1  
 building 1, 2nd floor | 077190 Voluntari, Ilfov  
 Tel.: +40-(0)31 421 85 68 | Email: info-RO@wago.com

Aveți întrebări despre produsele noastre?  
 Vă stăm la dispoziție pentru preluarea apelului la +40 (0) 31 421 85 68.



|                             |   |
|-----------------------------|---|
| Rated surge voltage (III/3) | 4 kV  |
| Rated voltage (III/2)       | 320 V   |
| Rated surge voltage (III/2) | 4 kV  |
| Nominal voltage (II/2)      | 630 V   |
| Rated surge voltage (II/2)  | 4 kV  |
| Rated current               | 12 A  |
| Legend (ratings)            | (III / 2) $\hat{=}$ Overvoltage category III / Pollution degree 2 |

**Approvals per UL 1059**

|                                |         |
|--------------------------------|---------|
| Rated voltage UL (Use Group B) | 300 V   |
| Rated current UL (Use Group B) | 15 A    |
| Rated voltage UL (Use Group D) | 300 V   |
| Rated current UL (Use Group D) | 10 A    |
| Approvals per                  | UL 1059 |

**Approvals per UL 1977**

|                       |       |
|-----------------------|-------|
| Rated voltage UL 1977 | 600 V |
| Rated current UL 1977 | 15 A  |

**Approvals per CSA**

|                                 |       |
|---------------------------------|-------|
| Rated voltage CSA (Use Group B) | 300 V |
| Rated current CSA (Use Group B) | 15 A  |
| Rated voltage CSA (Use Group D) | 300 V |
| Rated current CSA (Use Group D) | 10 A  |

**Connection data**

|                            |   |
|----------------------------|---|
| Pole No.                   | 6 |
| Total number of potentials | 6 |
| Number of connection types | 1 |
| Number of levels           | 1 |

**Geometrical Data**

|                         |                      |
|-------------------------|----------------------|
| Pin spacing             | 5 mm / 0.197 inch    |
| Width                   | 45.8 mm / 1.803 inch |
| Height                  | 36.1 mm / 1.421 inch |
| Height from the surface | 21.6 mm / 0.85 inch  |

Supus modificărilor.

WAGO Kontakttechnik GmbH & Co. KG  
 /Representative Office Romania  
 Sos. Pipera-Tunari nr. 1/1  
 building 1, 2nd floor | 077190 Voluntari, Ilfov  
 Tel.: +40-(0)31 421 85 68 | Email: info-RO@wago.com

Aveți întrebări despre produsele noastre?  
 Vă stăm la dispoziție pentru preluarea apelului la +40 (0) 31 421 85 68.

|       |                      |
|-------|----------------------|
| Depth | 11.6 mm / 0.457 inch |
|-------|----------------------|

### Plug connection

|   |                                       |
|---|---------------------------------------|
| Contact type (pluggable connector)                | Female connector/socket               |
| Connector (connection type)                       | for front-entry wiring terminal block |
| Mismatching protection                            | Yes                                   |
| Locking of plug-in connection                     | locking lever                         |
| Mating direction to the rail-mount terminal block | 90°                                   |

### Material Data

|                             |                      |
|-----------------------------|----------------------|
| Color                       | light gray           |
| Material group              | I                    |
| Insulation material         | Polyamide 66 (PA 66) |
| Flammability class per UL94 | V0                   |
| Contact material            | Copper alloy         |
| Contact plating             | tin-plated           |
| Fire load                   | 0,133 MJ             |
| Weight                      | 7,2 g                |

### Environmental Requirements

|                         |                |
|-------------------------|----------------|
| Limit temperature range | -60 ... +85 °C |
|-------------------------|----------------|

### Commercial data

|                       |                        |
|-----------------------|------------------------|
| Product Group         | 3 (Multi Conn. System) |
| Packaging type        | BOX                    |
| Country of origin     | DE                     |
| GTIN                  | 4044918571425          |
| Customs tariff number | 85366990990            |

### Aprobări / certificate

#### Country specific Approvals

| Emblemă  | Aprobare                        | Text de aprobare suplimentar | Nume certificat |
|--|---------------------------------|------------------------------|-----------------|
|  | CSA<br>DEKRA Certification B.V. | C22.2                        | 1466354         |

Supus modificărilor.



WAGO Kontakttechnik GmbH & Co. KG  
/Representative Office Romania  
Sos. Pipera-Tunari nr. 1/1  
building 1, 2nd floor | 077190 Voluntari, Ilfov  
Tel.: +40-(0)31 421 85 68 | Email: info-RO@wago.com

Aveți întrebări despre produsele noastre?  
Vă stăm la dispoziție pentru preluarea apelului la +40 (0) 31 421 85 68.

## Ship Approvals

| Emblemă  | Aprobare                                  | Text de aprobare suplimentar | Nume certificat          |
|--|---|------------------------------|--------------------------|
|  | <b>ABS</b><br>American Bureau of Shipping | -                            | 19-<br>HG1869876-<br>PDA |

## UL-Approvals

| Emblemă  | Aprobare                                    | Text de aprobare suplimentar | Nume certificat     |
|--|---|------------------------------|---------------------|
|  | <b>UL</b><br>Underwriters Laboratories Inc. | UL 1059                      | E45172-<br>19911118 |
|  | <b>UR</b><br>UL International Germany GmbH  | UL 1977                      | E45171              |

## Counterpart





Nr. articol 721-606

1-conductor male connector; 100% protected against mismatching; 2.5 mm<sup>2</sup>; Pin spacing 5 mm; 6-pole; 2,50 mm<sup>2</sup>; light gray[www.wago.com/721-606](http://www.wago.com/721-606)

## Produse compatibile

## General accessories

|  |   |  |
|--|---|--|
|  | <b>Nr. articol: 280-650/056-000</b><br>Spacer of same profile; suitable for 3-conductor terminal blocks of horizontal type; orange    | <a href="http://www.wago.com/280-650/056-000">www.wago.com/280-650/056-000</a> |
|  | <b>Nr. articol: 280-654/056-000</b><br>Spacer of same profile; suitable for 3- and 4-conductor terminal blocks of angled type; orange | <a href="http://www.wago.com/280-654/056-000">www.wago.com/280-654/056-000</a> |
|  | <b>Nr. articol: 280-835/056-000</b><br>Spacer of same profile; suitable for 4-conductor terminal blocks of horizontal type; orange    | <a href="http://www.wago.com/280-835/056-000">www.wago.com/280-835/056-000</a> |

Supus modificărilor.

WAGO Kontakttechnik GmbH & Co. KG  
/Representative Office Romania  
Sos. Pipera-Tunari nr. 1/1  
building 1, 2nd floor | 077190 Voluntari, Ilfov  
Tel.: +40-(0)31 421 85 68 | Email: info-RO@wago.com

Aveți întrebări despre produsele noastre?  
Vă stăm la dispoziție pentru preluarea apelului la +40 (0) 31 421 85 68.



Nr. articol: 280-902/056-000

Spacer of same profile; suitable for 2-conductor terminal blocks of horizontal type; orange

[www.wago.com/280-902/056-000](http://www.wago.com/280-902/056-000)

check



Nr. articol: 210-136

Test plug; 2 mm Ø; with 500 mm cable; red

[www.wago.com/210-136](http://www.wago.com/210-136)



Nr. articol: 210-137

Test plug; 2.3 mm Ø; with 500 mm cable; yellow

[www.wago.com/210-137](http://www.wago.com/210-137)



Nr. articol: 231-661

Test plugs for female connectors; for 5 mm and 5.08 mm pin spacing; 2,50 mm<sup>2</sup>; light gray

[www.wago.com/231-661](http://www.wago.com/231-661)

## Descărcări

### Documentation

#### Additional Information

|                        |             |               |            |
|------------------------|-------------|---------------|------------|
| Technical explanations | Apr 3, 2019 | pdf<br>3,6 MB | Descărcare |
|------------------------|-------------|---------------|------------|

### CAD/CAE-Data

#### CAD data

|                                      |     |            |
|--------------------------------------|-----|------------|
| 2D/3D Models 722-136/005-000/039-000 | URL | Descărcare |
|--------------------------------------|-----|------------|

#### CAE data

|   |     |            |
|---|-----|------------|
| EPLAN Data Portal 722-136/005-000/039-000 | URL | Descărcare |
|---|-----|------------|

### Installation Notes

### Familie de produse

<i>MCS</i> MIDI

Afișare globală produse din familie.

Supus modificărilor.