

RoHS Compliant

BOMcheck.net

Culoare:

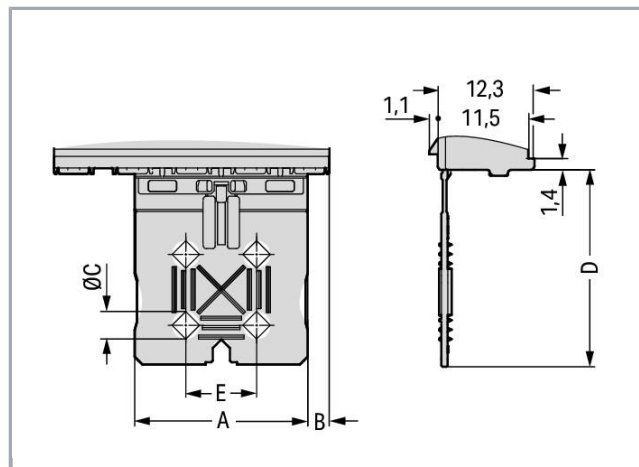

Date

Electrical data

Ratings per IEC/EN 60664-1

Legend (ratings)

(III / 2) ≙ Overvoltage category III / Pollution degree 2

Supus modificărilor.

WAGO Kontakttechnik GmbH & Co. KG
/Representative Office Romania
Sos. Pipera-Tunari nr. 1/1
building 1, 2nd floor | 077190 Voluntari, Ilfov
Tel.: +40-(0)31 421 85 68 | Email: info-RO@wago.com

Aveți întrebări despre produsele noastre?
Vă stăm la dispoziție pentru preluarea apelului la +40 (0) 31 421 85 68.



Approvals per UL 1059

Approvals per	UL 1059
---------------	---------

Connection data

Number of connection types	1
----------------------------	---

Geometrical Data

Pin spacing	7.5 mm / 0.295 inch
-------------	---------------------

Material Data

Color	light gray
Fire load	0,007 MJ
Weight	0,2 g

Commercial data

Product Group	26 (picoMAX)
Packaging type	BOX
Country of origin	DE
GTIN	4050821164913
Customs tariff number	85389099990

Counterpart

Descărcări

Documentation

Additional Information

Technical explanations	Apr 3, 2019	pdf 3,6 MB	Descărcare
------------------------	-------------	---------------	------------

Installation Notes

Strain Relief

Supus modificărilor.

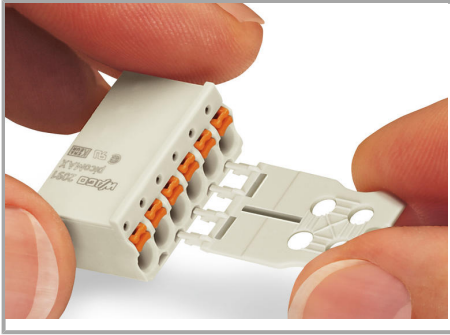

Gripping plates are suitable for factory and in-the-field assembly.

Supus modificărilor.