

Fișă tehnică | Număr articol: 2002-2248/099-000

Double-deck terminal block; Shield/through terminal block; Shield/N; with marker carrier; for DIN-rail 35 x 15 and 35 x 7.5; 2.5 mm<sup>2</sup>; Push-in CAGE CLAMP®; 2,50 mm<sup>2</sup>; gray

[www.wago.com/2002-2248/099-000](http://www.wago.com/2002-2248/099-000)

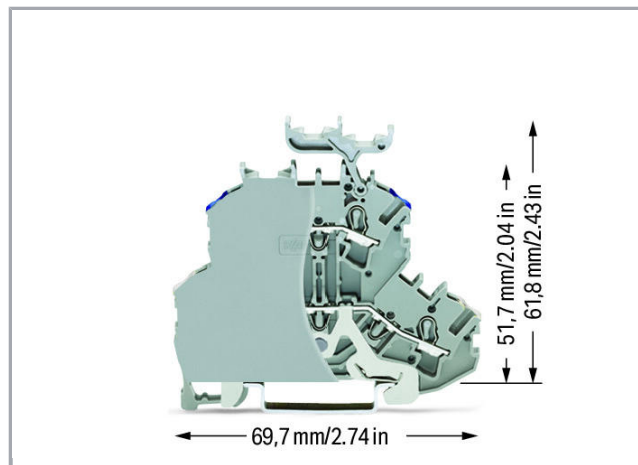

Supus modificărilor.

WAGO Kontakttechnik GmbH & Co. KG  
/Representative Office Romania  
Sos. Pipera-Tunari nr. 1/1  
building 1, 2nd floor | 077190 Voluntari, Ilfov  
Tel.: +40-(0)31 421 85 68 | Email: info-RO@wago.com

Aveți întrebări despre produsele noastre?  
Vă stăm la dispoziție pentru preluarea apelului la +40 (0) 31 421 85 68.

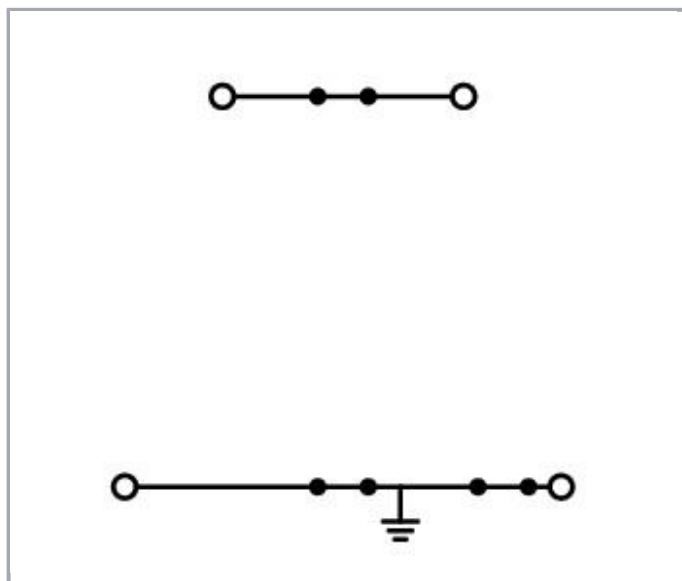
**Date****Electrical data****Ratings per IEC/EN 60664-1**

Ratings per	IEC/EN 60947-7-1
Nominal voltage (III/3)	800 V
Rated surge voltage (III/3)	8 kV
Rated current	24 A
Legend (ratings)	(III / 3) ≙ Overvoltage category III / Pollution degree 3

**Approvals per UL 1059**

Rated voltage UL (Use Group B)	600 V
Rated current UL (Use Group B)	20 A
Rated voltage UL (Use Group C)	600 V
Rated current UL (Use Group C)	20 A
Rated voltage UL (Use Group D)	600 V
Rated current UL (Use Group D)	5 A
Approvals per	UL 1059

**Connection data**

Connection technology	Push-in CAGE CLAMP®
Number of connection points (connection type)	2

Supus modificărilor.



Actuation type	Push-in Open Tool Slot
Connectable conductor materials	Copper
Nominal cross-section	2,5 mm <sup>2</sup>
Solid conductor	0,25 ... 4 mm <sup>2</sup> / 22 ... 12 AWG
Solid conductor; push-in termination	0,75 ... 4 mm <sup>2</sup> / 18 ... 12 AWG
Fine-stranded conductor	0,25 ... 4 mm <sup>2</sup> / 22 ... 12 AWG
Fine-stranded conductor; with insulated ferrule	1 ... 2,5 mm <sup>2</sup> / 18 ... 12 AWG
Fine-stranded conductor; with ferrule; push-in termination	1 ... 2,5 mm <sup>2</sup> / 18 ... 12 AWG
Strip length	10 ... 12 mm / 0.39 ... 0.47 inch
Number of connection points	2
Total number of connection points	4
Total number of potentials	2
Number of levels	2
Wiring type	Front-entry wiring
Note (conductor cross-section)	Depending on the conductor characteristic, a conductor with a smaller cross-section can also be inserted via push-in termination.

### Geometrical Data

Width	6,2 mm / 0.244 inch
Height from upper-edge of DIN-rail	61,8 mm / 2.433 inch
Depth	69,7 mm / 2.744 inch

### Mechanical data

Design	horizontal type
Mounting type	DIN-35 rail
Potential marking	Schirm//N
Marking level	Center/side marking

### Material Data

Color	gray
Insulation material	Polyamide 66 (PA 66)
Fire load	0,303 MJ
Weight	16,4 g

### Commercial data

Packaging type	BOX
----------------	-----

Supus modificărilor.



WAGO Kontakttechnik GmbH & Co. KG  
 /Representative Office Romania  
 Sos. Pipera-Tunari nr. 1/1  
 building 1, 2nd floor | 077190 Voluntari, Ilfov  
 Tel.: +40-(0)31 421 85 68 | Email: info-RO@wago.com

Aveți întrebări despre produsele noastre?  
 Vă stăm la dispoziție pentru preluarea apelului la +40 (0) 31 421 85 68.



Country of origin	DE
GTIN	4050821299165
Customs tariff number	85369010000

## Aprobări / certificate

### Country specific Approvals

Emblemă	Aprobare	Text de aprobare suplimentar	Nume certificat
	<b>CCA</b> DEKRA Certification B.V.	EN 60947	NTR NL 7730
	<b>CSA</b> DEKRA Certification B.V.	C22.2 No. 158	1536069
	<b>KEMA/KEUR</b> DEKRA Certification B.V.	EN 60947	71- 107687

### Ship Approvals

Emblemă	Aprobare	Text de aprobare suplimentar	Nume certificat
	<b>ABS</b> American Bureau of Shipping	EN 60947	20- HG1941090- PDA
	<b>BV</b> Bureau Veritas S.A.	EN 60947	38586/A0 BV
	<b>DNV GL</b> Det Norske Veritas, Germanischer Lloyd	-	TAE00001V2

### UL-Approvals

Emblemă	Aprobare	Text de aprobare suplimentar	Nume certificat
	<b>cURus</b> Underwriters Laboratories Inc.	UL 1059	E45172

Supus modificărilor.

WAGO Kontakttechnik GmbH & Co. KG  
/Representative Office Romania  
Sos. Pipera-Tunari nr. 1/1  
building 1, 2nd floor | 077190 Voluntari, Ilfov  
Tel.: +40-(0)31 421 85 68 | Email: info-RO@wago.com







Aveți întrebări despre produsele noastre?  
Vă stăm la dispoziție pentru preluarea apelului la +40 (0) 31 421 85 68.



## Counterpart

## Produce compatibile

### Carrier rail

	<b>Nr. articol: 210-112</b> Steel carrier rail; 35 x 7.5 mm; 1 mm thick; 2 m long; slotted; according to EN 60715; "Hole width 25 mm	<a href="http://www.wago.com/210-112">www.wago.com/210-112</a>
	<b>Nr. articol: 210-113</b> Steel carrier rail; 35 x 7.5 mm; 1 mm thick; 2 m long; unslotted; according to EN 60715	<a href="http://www.wago.com/210-113">www.wago.com/210-113</a>
	<b>Nr. articol: 210-114</b> Steel carrier rail; 35 x 15 mm; 1.5 mm thick; 2 m long; unslotted; similar to EN 60715	<a href="http://www.wago.com/210-114">www.wago.com/210-114</a>
	<b>Nr. articol: 210-115</b> Steel carrier rail; 35 x 7.5 mm; 1 mm thick; 2 m long; slotted; according to EN 60715; "Hole width 18 mm	<a href="http://www.wago.com/210-115">www.wago.com/210-115</a>
	<b>Nr. articol: 210-118</b> Steel carrier rail; 35 x 15 mm; 2.3 mm thick; 2 m long; unslotted; according to EN 60715	<a href="http://www.wago.com/210-118">www.wago.com/210-118</a>
	<b>Nr. articol: 210-196</b> Aluminum carrier rail; 35 x 8.2 mm; 1.6 mm thick; 2 m long; unslotted; similar to EN 60715; silver-colored	<a href="http://www.wago.com/210-196">www.wago.com/210-196</a>
	<b>Nr. articol: 210-197</b> Steel carrier rail; 35 x 15 mm; 1.5 mm thick; 2 m long; slotted; similar to EN 60715	<a href="http://www.wago.com/210-197">www.wago.com/210-197</a>
	<b>Nr. articol: 210-198</b> Copper carrier rail; 35 x 15 mm; 2.3 mm thick; 2 m long; unslotted; according to EN 60715; copper-colored	<a href="http://www.wago.com/210-198">www.wago.com/210-198</a>
	<b>Nr. articol: 210-504</b> Steel carrier rail; 35 x 7.5 mm; 1 mm thick; 2 m long; slotted; galvanized; according to EN 60715	<a href="http://www.wago.com/210-504">www.wago.com/210-504</a>
	<b>Nr. articol: 210-505</b> Steel carrier rail; 35 x 7.5 mm; 1 mm thick; 2 m long; unslotted; galvanized; according to EN 60715	<a href="http://www.wago.com/210-505">www.wago.com/210-505</a>

Supus modificărilor.

**Nr. articol: 210-506**

Steel carrier rail; 35 x 15 mm; 1.5 mm thick; 2 m long; unslotted; galvanized; similar to EN 60715

[www.wago.com/210-506](http://www.wago.com/210-506)**Nr. articol: 210-508**

Steel carrier rail; 35 x 15 mm; 1.5 mm thick; 2 m long; slotted; galvanized; similar to EN 60715

[www.wago.com/210-508](http://www.wago.com/210-508)**Jumper****Nr. articol: 2002-492**

Double-deck vertical jumper; insulated; light gray

[www.wago.com/2002-492](http://www.wago.com/2002-492)**Nr. articol: 2002-492/000-012**

Double-deck vertical jumper; insulated; orange

[www.wago.com/2002-492/000-012](http://www.wago.com/2002-492/000-012)**Nr. articol: 2004-402**

Push-in type jumper bar; insulated; 2-way; Nominal current 32 A; light gray

[www.wago.com/2004-402](http://www.wago.com/2004-402)**Nr. articol: 2004-403**

Push-in type jumper bar; insulated; 3-way; Nominal current 32 A; light gray

[www.wago.com/2004-403](http://www.wago.com/2004-403)**Nr. articol: 2004-404**

Push-in type jumper bar; insulated; 4-way; Nominal current 32 A; light gray

[www.wago.com/2004-404](http://www.wago.com/2004-404)**Nr. articol: 2004-405**

Push-in type jumper bar; insulated; 5-way; Nominal current 32 A; light gray

[www.wago.com/2004-405](http://www.wago.com/2004-405)**Nr. articol: 2004-405/011-000**

Star point jumper; insulated; 3-way (1-3-5); IN = IN terminal block; light gray

[www.wago.com/2004-405/011-000](http://www.wago.com/2004-405/011-000)**Nr. articol: 2004-406**

Push-in type jumper bar; insulated; 6-way; Nominal current 32 A; light gray

[www.wago.com/2004-406](http://www.wago.com/2004-406)**Nr. articol: 2004-406/020-000**

Delta jumper; insulated; 1-2 3-4 5-6; IN = IN terminal block; light gray

[www.wago.com/2004-406/020-000](http://www.wago.com/2004-406/020-000)**Nr. articol: 2004-407**

Push-in type jumper bar; insulated; 7-way; Nominal current 32 A; light gray

[www.wago.com/2004-407](http://www.wago.com/2004-407)**Nr. articol: 2004-408**

Push-in type jumper bar; insulated; 8-way; Nominal current 32 A; light gray

[www.wago.com/2004-408](http://www.wago.com/2004-408)**Nr. articol: 2004-409**

Push-in type jumper bar; insulated; 9-way; Nominal current 32 A; light gray

[www.wago.com/2004-409](http://www.wago.com/2004-409)**Nr. articol: 2004-410**















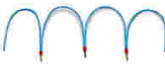

Push-in type jumper bar; insulated; 10-way; Nominal current 32 A; light gray

[www.wago.com/2004-410](http://www.wago.com/2004-410)**Nr. articol: 2004-433**

Push-in type jumper bar; insulated; from 1 to 3; Nominal current 32 A; light gray

[www.wago.com/2004-433](http://www.wago.com/2004-433)

Supus modificărilor.

	<b>Nr. articol: 2004-434</b> Push-in type jumper bar; insulated; from 1 to 4; Nominal current 32 A; light gray	<a href="http://www.wago.com/2004-434">www.wago.com/2004-434</a>
	<b>Nr. articol: 2004-435</b> Push-in type jumper bar; insulated; from 1 to 5; Nominal current 32 A; light gray	<a href="http://www.wago.com/2004-435">www.wago.com/2004-435</a>
	<b>Nr. articol: 2004-436</b> Push-in type jumper bar; insulated; from 1 to 6; Nominal current 32 A; light gray	<a href="http://www.wago.com/2004-436">www.wago.com/2004-436</a>
	<b>Nr. articol: 2004-437</b> Push-in type jumper bar; insulated; from 1 to 7; Nominal current 32 A; light gray	<a href="http://www.wago.com/2004-437">www.wago.com/2004-437</a>
	<b>Nr. articol: 2004-438</b> Push-in type jumper bar; insulated; from 1 to 8; Nominal current 32 A; light gray	<a href="http://www.wago.com/2004-438">www.wago.com/2004-438</a>
	<b>Nr. articol: 2004-439</b> Push-in type jumper bar; insulated; from 1 to 9; Nominal current 32 A; light gray	<a href="http://www.wago.com/2004-439">www.wago.com/2004-439</a>
	<b>Nr. articol: 2004-440</b> Push-in type jumper bar; insulated; from 1 to 10; Nominal current 32 A; light gray	<a href="http://www.wago.com/2004-440">www.wago.com/2004-440</a>
	<b>Nr. articol: 210-103</b> Wire commoning chain; insulated; 50 connections; black	<a href="http://www.wago.com/210-103">www.wago.com/210-103</a>
	<b>Nr. articol: 210-123</b> Wire commoning chain; insulated; 50 connections	<a href="http://www.wago.com/210-123">www.wago.com/210-123</a>
<b>Protective Warning Marker</b>		
	<b>Nr. articol: 2002-115</b> Protective warning marker; with high-voltage symbol, black; for 5 terminal blocks; yellow	<a href="http://www.wago.com/2002-115">www.wago.com/2002-115</a>
<b>tools</b>		
	<b>Nr. articol: 210-658</b> Operating tool; Blade: 3.5 x 0.5 mm; with a partially insulated shaft; angled; short	<a href="http://www.wago.com/210-658">www.wago.com/210-658</a>
	<b>Nr. articol: 210-720</b> Operating tool; Blade: 3.5 x 0.5 mm; with a partially insulated shaft	<a href="http://www.wago.com/210-720">www.wago.com/210-720</a>
<b>Push-In type wire jumper</b>		
	<b>Nr. articol: 2009-412</b> Push-in type wire jumper; insulated; wire length 60 mm; Conductor cross section 1.5 mm <sup>2</sup> ; suitable for 2001, 2002, 2003 and 2022 Series rail-mounted terminal blocks; black	<a href="http://www.wago.com/2009-412">www.wago.com/2009-412</a>
	<b>Nr. articol: 2009-414</b> Push-in type wire jumper; insulated; wire length 110 mm; Conductor cross section 1.5 mm <sup>2</sup> ; suitable for 2001, 2002, 2003 and 2022 Series rail-mounted terminal blocks; black	<a href="http://www.wago.com/2009-414">www.wago.com/2009-414</a>
	<b>Nr. articol: 2009-414/000-005</b> Push-in type wire jumper; insulated; wire length 110 mm; Conductor cross section 1.5 mm <sup>2</sup> ; suitable for 2001, 2002, 2003 and 2022 Series rail-mounted terminal blocks; red	<a href="http://www.wago.com/2009-414/000-005">www.wago.com/2009-414/000-005</a>
	<b>Nr. articol: 2009-414/000-006</b> Push-in type wire jumper; insulated; wire length 110 mm; Conductor cross section 1.5 mm <sup>2</sup> ; suitable for 2001, 2002, 2003 and 2022 Series rail-mounted terminal blocks; blue	<a href="http://www.wago.com/2009-414/000-006">www.wago.com/2009-414/000-006</a>

Supus modificărilor.

**Nr. articol: 2009-416**

Push-in type wire jumper; insulated; wire length 250 mm; Conductor cross section 1.5 mm<sup>2</sup>; suitable for 2001, 2002, 2003 and 2022 Series rail-mounted terminal blocks; black [www.wago.com/2009-416](http://www.wago.com/2009-416)

**ferrule****Nr. articol: 216-241**

Ferrule; Sleeve for 0.5 mm<sup>2</sup> / 20 AWG; insulated; electro-tin plated; electrolytic copper; gastight crimped; acc. to DIN 46228, Part 4/09.90; white [www.wago.com/216-241](http://www.wago.com/216-241)

**Nr. articol: 216-242**

Ferrule; Sleeve for 0.75 mm<sup>2</sup> / 18 AWG; insulated; electro-tin plated; electrolytic copper; gastight crimped; acc. to DIN 46228, Part 4/09.90; gray [www.wago.com/216-242](http://www.wago.com/216-242)

**Nr. articol: 216-243**

Ferrule; Sleeve for 1 mm<sup>2</sup> / AWG 18; insulated; electro-tin plated; electrolytic copper; gastight crimped; acc. to DIN 46228, Part 4/09.90; red [www.wago.com/216-243](http://www.wago.com/216-243)

**Nr. articol: 216-244**

Ferrule; Sleeve for 1.5 mm<sup>2</sup> / AWG 16; insulated; electro-tin plated; electrolytic copper; gastight crimped; acc. to DIN 46228, Part 4/09.90; black [www.wago.com/216-244](http://www.wago.com/216-244)

**Nr. articol: 216-246**

Ferrule; Sleeve for 2.5 mm<sup>2</sup> / AWG 14; insulated; electro-tin plated; electrolytic copper; gastight crimped; acc. to DIN 46228, Part 4/09.90; blue [www.wago.com/216-246](http://www.wago.com/216-246)

**Nr. articol: 216-262**

Ferrule; Sleeve for 0.75 mm<sup>2</sup> / 18 AWG; insulated; electro-tin plated; electrolytic copper; gastight crimped; acc. to DIN 46228, Part 4/09.90; gray [www.wago.com/216-262](http://www.wago.com/216-262)

**Nr. articol: 216-263**

Ferrule; Sleeve for 1 mm<sup>2</sup> / AWG 18; insulated; electro-tin plated; electrolytic copper; gastight crimped; acc. to DIN 46228, Part 4/09.90; red [www.wago.com/216-263](http://www.wago.com/216-263)

**Nr. articol: 216-264**

Ferrule; Sleeve for 1.5 mm<sup>2</sup> / AWG 16; insulated; electro-tin plated; electrolytic copper; gastight crimped; acc. to DIN 46228, Part 4/09.90; black [www.wago.com/216-264](http://www.wago.com/216-264)

**Nr. articol: 216-266**

Ferrule; Sleeve for 2.5 mm<sup>2</sup> / AWG 14; insulated; electro-tin plated; electrolytic copper; gastight crimped; acc. to DIN 46228, Part 4/09.90; blue [www.wago.com/216-266](http://www.wago.com/216-266)

**Insulation stop****Nr. articol: 2002-171**

Insulation stop; 0.25 - 0.5 mm<sup>2</sup>; 5 pieces/strip; light gray [www.wago.com/2002-171](http://www.wago.com/2002-171)

**Nr. articol: 2002-172**

Insulation stop; 0.75 - 1 mm<sup>2</sup>; 5 pieces/strip; dark gray [www.wago.com/2002-172](http://www.wago.com/2002-172)

**check****Nr. articol: 2002-611**

TOPJOB®S L-type test plug module; modular; 1-pole; 2,50 mm<sup>2</sup>; gray [www.wago.com/2002-611](http://www.wago.com/2002-611)

**Nr. articol: 2002-649**

TOPJOB®S L-type spacer module; modular; e.g., for bridging commoned terminal blocks; gray [www.wago.com/2002-649](http://www.wago.com/2002-649)

**Nr. articol: 2009-174**

Test plug adapter; for 4 mm Ø test plugs; for testing TOPJOB®S rail-mounted terminal blocks; gray [www.wago.com/2009-174](http://www.wago.com/2009-174)

Supus modificărilor.



**Nr. articol: 2009-182**Testing tap; for max. 2.5 mm<sup>2</sup>; tool-free connection for individual test wires 0.08 - 2.5 mm; gray[www.wago.com/2009-182](http://www.wago.com/2009-182)**Marking accessories****Nr. articol: 2009-110**

Marking strips; on reel; not stretchable; plain; snap-on type; white

[www.wago.com/2009-110](http://www.wago.com/2009-110)**Nr. articol: 2009-115**

WMB-Inline; for Smart Printer; 1500 pieces on roll; stretchable 5 - 5.2 mm; plain; snap-on type; white

[www.wago.com/2009-115](http://www.wago.com/2009-115)**Nr. articol: 2009-115/000-002**

WMB-Inline; for Smart Printer; 1500 pieces on roll; stretchable 5 - 5.2 mm; plain; snap-on type; yellow

[www.wago.com/2009-115/000-002](http://www.wago.com/2009-115/000-002)**Nr. articol: 2009-115/000-005**

WMB-Inline; for Smart Printer; 1500 pieces on roll; stretchable 5 - 5.2 mm; plain; snap-on type; red

[www.wago.com/2009-115/000-005](http://www.wago.com/2009-115/000-005)**Nr. articol: 2009-115/000-006**

WMB-Inline; for Smart Printer; 1500 pieces on roll; stretchable 5 - 5.2 mm; plain; snap-on type; blue

[www.wago.com/2009-115/000-006](http://www.wago.com/2009-115/000-006)**Nr. articol: 2009-115/000-007**

WMB-Inline; for Smart Printer; 1500 pieces on roll; stretchable 5 - 5.2 mm; plain; snap-on type; gray

[www.wago.com/2009-115/000-007](http://www.wago.com/2009-115/000-007)**Nr. articol: 2009-115/000-012**

WMB-Inline; for Smart Printer; 1500 pieces on roll; stretchable 5 - 5.2 mm; plain; snap-on type; orange

[www.wago.com/2009-115/000-012](http://www.wago.com/2009-115/000-012)**Nr. articol: 2009-115/000-017**

WMB-Inline; for Smart Printer; 1500 pieces on roll; stretchable 5 - 5.2 mm; plain; snap-on type; light green

[www.wago.com/2009-115/000-017](http://www.wago.com/2009-115/000-017)**Nr. articol: 2009-115/000-023**

WMB-Inline; for Smart Printer; 1500 pieces on roll; stretchable 5 - 5.2 mm; plain; snap-on type; green

[www.wago.com/2009-115/000-023](http://www.wago.com/2009-115/000-023)**Nr. articol: 2009-115/000-024**

WMB-Inline; for Smart Printer; 1500 pieces on roll; stretchable 5 - 5.2 mm; plain; snap-on type; violet

[www.wago.com/2009-115/000-024](http://www.wago.com/2009-115/000-024)**Nr. articol: 2009-135**

WMB-Inline; for Smart Printer; on reel; stretchable 5 - 5.2 mm; plain; snap-on type; white

[www.wago.com/2009-135](http://www.wago.com/2009-135)**Nr. articol: 2009-145**















Mini-WSB Inline; for Smart Printer; 1700 pieces on roll; stretchable 5 - 5.2 mm; plain; snap-on type; white

[www.wago.com/2009-145](http://www.wago.com/2009-145)**Nr. articol: 2009-145/000-002**

Mini-WSB Inline; for Smart Printer; 1700 pieces on roll; stretchable 5 - 5.2 mm; plain; snap-on type; yellow

[www.wago.com/2009-145/000-002](http://www.wago.com/2009-145/000-002)

Supus modificărilor.

	<b>Nr. articol: 2009-145/000-005</b> Mini-WSB Inline; for Smart Printer; 1700 pieces on roll; stretchable 5 - 5.2 mm; plain; snap-on type; red /000-005	<a href="http://www.wago.com/2009-145/000-005">www.wago.com/2009-145/000-005</a>
	<b>Nr. articol: 2009-145/000-006</b> Mini-WSB Inline; for Smart Printer; 1700 pieces on roll; stretchable 5 - 5.2 mm; plain; snap-on type; blue	<a href="http://www.wago.com/2009-145/000-006">www.wago.com/2009-145/000-006</a>
	<b>Nr. articol: 2009-145/000-007</b> Mini-WSB Inline; for Smart Printer; 1700 pieces on roll; stretchable 5 - 5.2 mm; plain; snap-on type; gray	<a href="http://www.wago.com/2009-145/000-007">www.wago.com/2009-145/000-007</a>
	<b>Nr. articol: 2009-145/000-012</b> Mini-WSB Inline; for Smart Printer; 1700 pieces on roll; stretchable 5 - 5.2 mm; plain; snap-on type; orange	<a href="http://www.wago.com/2009-145/000-012">www.wago.com/2009-145/000-012</a>
	<b>Nr. articol: 2009-145/000-023</b> Mini-WSB Inline; for Smart Printer; 1700 pieces on roll; stretchable 5 - 5.2 mm; plain; snap-on type; green	<a href="http://www.wago.com/2009-145/000-023">www.wago.com/2009-145/000-023</a>
	<b>Nr. articol: 2009-145/000-024</b> Mini-WSB Inline; for Smart Printer; 1700 pieces on roll; stretchable 5 - 5.2 mm; plain; snap-on type; violet	<a href="http://www.wago.com/2009-145/000-024">www.wago.com/2009-145/000-024</a>
	<b>Nr. articol: 2009-191</b> Group marker carrier	<a href="http://www.wago.com/2009-191">www.wago.com/2009-191</a>
	<b>Nr. articol: 2009-192</b> Group marker carrier	<a href="http://www.wago.com/2009-192">www.wago.com/2009-192</a>
	<b>Nr. articol: 2009-193</b> Group marker carrier	<a href="http://www.wago.com/2009-193">www.wago.com/2009-193</a>
	<b>Nr. articol: 2009-198</b> Adaptor	<a href="http://www.wago.com/2009-198">www.wago.com/2009-198</a>
	<b>Nr. articol: 248-501</b> Miniature WSB Quick marking system; plain; Marker width 5 mm; 10 strips with 10 markers per card	<a href="http://www.wago.com/248-501">www.wago.com/248-501</a>
	<b>Nr. articol: 248-501/000-002</b> Mini-WSB marking card; as card; not stretchable; plain; snap-on type; yellow	<a href="http://www.wago.com/248-501/000-002">www.wago.com/248-501/000-002</a>
	<b>Nr. articol: 248-501/000-005</b> Mini-WSB marking card; as card; not stretchable; plain; snap-on type; red	<a href="http://www.wago.com/248-501/000-005">www.wago.com/248-501/000-005</a>
	<b>Nr. articol: 248-501/000-006</b> Mini-WSB marking card; as card; not stretchable; plain; snap-on type; blue	<a href="http://www.wago.com/248-501/000-006">www.wago.com/248-501/000-006</a>
	<b>Nr. articol: 248-501/000-007</b> Mini-WSB marking card; as card; not stretchable; plain; snap-on type; gray	<a href="http://www.wago.com/248-501/000-007">www.wago.com/248-501/000-007</a>

Supus modificărilor.

WAGO Kontakttechnik GmbH & Co. KG  
/Representative Office Romania  
Sos. Pipera-Tunari nr. 1/1  
building 1, 2nd floor | 077190 Voluntari, Ilfov  
Tel.: +40-(0)31 421 85 68 | Email: info-RO@wago.com

Aveți întrebări despre produsele noastre?  
Vă stăm la dispoziție pentru preluarea apelului la +40 (0) 31 421 85 68.



**Nr. articol: 248-501/000-012**  
Mini-WSB marking card; as card; not stretchable; plain; snap-on type; orange

[www.wago.com/248-501/000-012](http://www.wago.com/248-501/000-012)



**Nr. articol: 248-501/000-017**  
Mini-WSB marking card; as card; not stretchable; plain; snap-on type; light green

[www.wago.com/248-501/000-017](http://www.wago.com/248-501/000-017)



**Nr. articol: 248-501/000-023**  
Mini-WSB marking card; as card; not stretchable; plain; snap-on type; green

[www.wago.com/248-501/000-023](http://www.wago.com/248-501/000-023)



**Nr. articol: 248-501/000-024**  
Mini-WSB marking card; as card; not stretchable; plain; snap-on type; violet

[www.wago.com/248-501/000-024](http://www.wago.com/248-501/000-024)



**Nr. articol: 793-501**  
WMB marking card; as card; not stretchable; plain; snap-on type; white

[www.wago.com/793-501](http://www.wago.com/793-501)



**Nr. articol: 793-501/000-002**  
WMB marking card; as card; not stretchable; plain; snap-on type; yellow

[www.wago.com/793-501/000-002](http://www.wago.com/793-501/000-002)



**Nr. articol: 793-501/000-005**  
WMB marking card; as card; not stretchable; plain; snap-on type; red

[www.wago.com/793-501/000-005](http://www.wago.com/793-501/000-005)



**Nr. articol: 793-501/000-006**  
WMB marking card; as card; not stretchable; plain; snap-on type; blue

[www.wago.com/793-501/000-006](http://www.wago.com/793-501/000-006)



**Nr. articol: 793-501/000-007**  
WMB marking card; as card; not stretchable; plain; snap-on type; gray

[www.wago.com/793-501/000-007](http://www.wago.com/793-501/000-007)



**Nr. articol: 793-501/000-012**  
WMB marking card; as card; not stretchable; plain; snap-on type; orange

[www.wago.com/793-501/000-012](http://www.wago.com/793-501/000-012)



**Nr. articol: 793-501/000-017**  
WMB marking card; as card; not stretchable; plain; snap-on type; light green

[www.wago.com/793-501/000-017](http://www.wago.com/793-501/000-017)



**Nr. articol: 793-501/000-023**  
WMB marking card; as card; not stretchable; plain; snap-on type; green

[www.wago.com/793-501/000-023](http://www.wago.com/793-501/000-023)



**Nr. articol: 793-501/000-024**  
WMB marking card; as card; not stretchable; plain; snap-on type; violet

[www.wago.com/793-501/000-024](http://www.wago.com/793-501/000-024)

**Nr. articol: 793-5501**  
WMB marking card; as card; for terminal block width 5 - 17.5 mm; stretchable 5 - 5.2 mm; plain; snap- [www.wago.com/793-5501](http://www.wago.com/793-5501)

Supus modificărilor.



on type; white

**Nr. articol: 793-5501/000-002**

WMB marking card; as card; for terminal block width 5 - 17.5 mm; stretchable 5 - 5.2 mm; plain; snap-on type; yellow

[www.wago.com/793-5501/000-002](http://www.wago.com/793-5501/000-002)**Nr. articol: 793-5501/000-005**

WMB marking card; as card; for terminal block width 5 - 17.5 mm; stretchable 5 - 5.2 mm; plain; snap-on type; red

[www.wago.com/793-5501/000-005](http://www.wago.com/793-5501/000-005)**Nr. articol: 793-5501/000-006**

WMB marking card; as card; for terminal block width 5 - 17.5 mm; stretchable 5 - 5.2 mm; plain; snap-on type; blue

[www.wago.com/793-5501/000-006](http://www.wago.com/793-5501/000-006)**Nr. articol: 793-5501/000-007**

WMB marking card; as card; for terminal block width 5 - 17.5 mm; stretchable 5 - 5.2 mm; plain; snap-on type; gray

[www.wago.com/793-5501/000-007](http://www.wago.com/793-5501/000-007)**Nr. articol: 793-5501/000-012**

WMB marking card; as card; for terminal block width 5 - 17.5 mm; stretchable 5 - 5.2 mm; plain; snap-on type; orange

[www.wago.com/793-5501/000-012](http://www.wago.com/793-5501/000-012)**Nr. articol: 793-5501/000-014**

WMB marking card; as card; for terminal block width 5 - 17.5 mm; stretchable 5 - 5.2 mm; plain; snap-on type; brown

[www.wago.com/793-5501/000-014](http://www.wago.com/793-5501/000-014)**Nr. articol: 793-5501/000-017**

WMB marking card; as card; for terminal block width 5 - 17.5 mm; stretchable 5 - 5.2 mm; plain; snap-on type; green

[www.wago.com/793-5501/000-017](http://www.wago.com/793-5501/000-017)**Nr. articol: 793-5501/000-023**

WMB marking card; as card; for terminal block width 5 - 17.5 mm; stretchable 5 - 5.2 mm; plain; snap-on type; light green

[www.wago.com/793-5501/000-023](http://www.wago.com/793-5501/000-023)**Nr. articol: 793-5501/000-024**

WMB marking card; as card; for terminal block width 5 - 17.5 mm; stretchable 5 - 5.2 mm; plain; snap-on type; violet

[www.wago.com/793-5501/000-024](http://www.wago.com/793-5501/000-024)

## Descărcări

### Documentation

#### Additional Information

Technical explanations

Apr 3, 2019

pdf  
2,1 MB

Descărcare

## CAD/CAE-Data

### CAD data

Supus modificărilor.

WAGO Kontakttechnik GmbH & Co. KG  
/Representative Office Romania  
Sos. Pipera-Tunari nr. 1/1  
building 1, 2nd floor | 077190 Voluntari, Ilfov  
Tel.: +40-(0)31 421 85 68 | Email: info-RO@wago.com

Aveți întrebări despre produsele noastre?  
Vă stăm la dispoziție pentru preluarea apelului la +40 (0) 31 421 85 68.

2D/3D Models 2002-2248/099-000

[URL](#)

[Descărcare](#)

#### CAE data

EPLAN Data Portal 2002-2248/099-000

[URL](#)

[Descărcare](#)

WSCAD Universe 2002-2248/099-000

[URL](#)

[Descărcare](#)

## Installation Notes

### Conductor termination

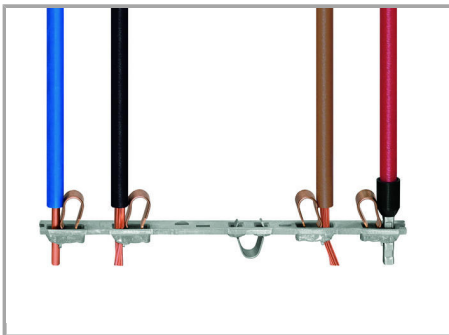

All conductor types at a glance

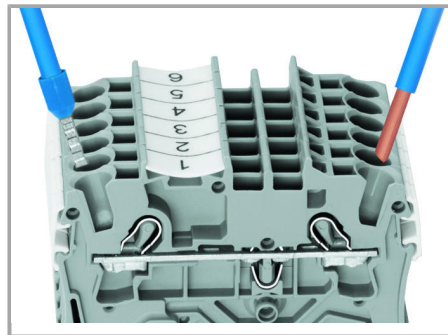

Terminating solid and ferruled conductors via push-in connection.

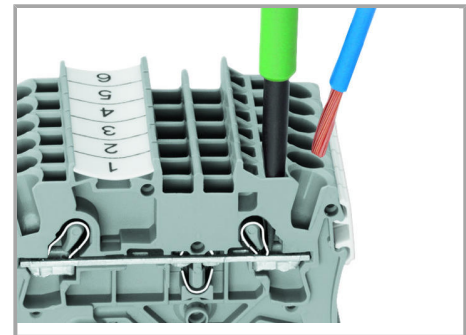

Inserting a conductor via operating tool.

Connecting fine-stranded conductors without ferrules, or small cross-sectional conductors that cannot be pushed in, is performed similarly to the original CAGE CLAMP® – just use an operating tool.

#### The smart feature:

To open the clamp, the operating tool is inserted vertically. The conductor entry is less than 15 degrees for easier wiring.

Supus modificărilor.

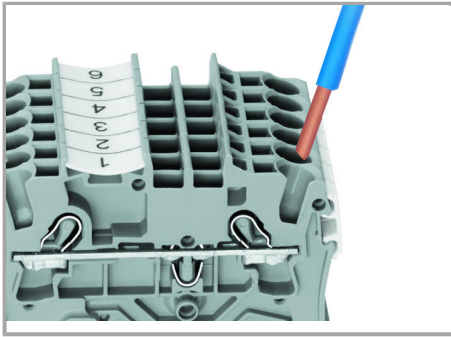

Inserting conductors via push-in termination.



Conductor termination – Insulation stop.

Solid conductors with cross-sections from either one size above, or up to two sizes below, the rated cross-section can be simply pushed in – no tools needed.

#### Marking

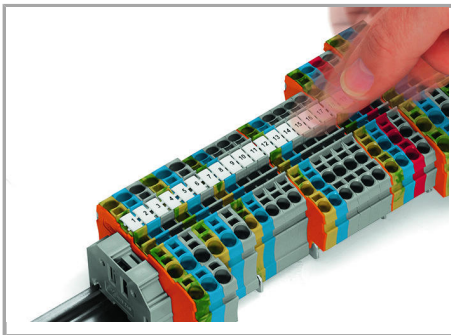

Snapping WMB Inline markers into marker slots.

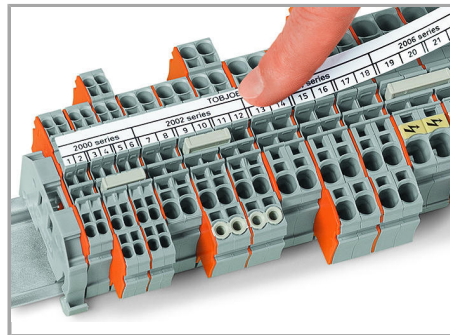

Supus modificărilor.

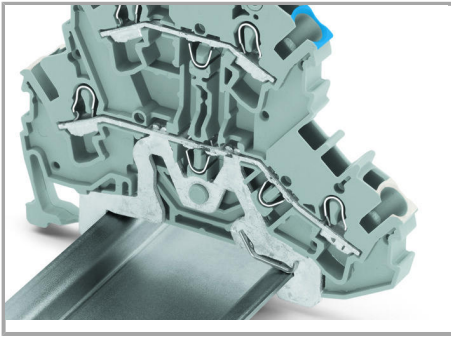

Supus modificărilor.

WAGO Kontakttechnik GmbH & Co. KG  
/Representative Office Romania  
Sos. Pipera-Tunari nr. 1/1  
building 1, 2nd floor | 077190 Voluntari, Ilfov  
Tel.: +40-(0)31 421 85 68 | Email: info-RO@wago.com

Aveți întrebări despre produsele noastre?  
Vă stăm la dispoziție pentru preluarea apelului la +40 (0) 31 421 85 68.



Both ground and shield conductor terminal blocks have a contact foot in the bottom level, automatically establishing direct contact to the carrier rail or busbar.

The flexible double-deck marker carrier, which is placed above the wiring level, can be pushed aside during wiring. The carrier has two staggered levels for WMB markers that perfectly line up to the terminal block decks.

With a terminal block width of just 5.2 mm, an effective width of just 2.6 mm for terminal blocks of same or different potentials can be realized for conductors ranging 0.25 mm<sup>2</sup> ... 4 mm<sup>2</sup> (22 ... 12 AWG).

Shielded control cables are becoming an increasingly common solution to external signal interference.

Front-entry shield conductor terminal blocks are ideally suited to connect braided cables. Like front-entry ground conductor terminal blocks, they are equipped with a grounding foot for direct electrical connection to the rail, however they differ significantly by their white insulated housing. Front-entry shield conductor terminal blocks can be directly mounted beside signal-conductor terminal blocks, providing excellent deflection of interfering signals.

## Familie de produse

### TOPJOB® S

TOPJOB® S: In various industrial applications and modern building installations, WAGO's wide and versatile range of rail-mount terminal blocks provides more than just reliable electrical connections.

[Afișare globală produse din familie.](#)

Supus modificărilor.