

## Fișă tehnică | Număr articol: 2000-2203

Double-deck terminal block; Through/through terminal block; L/N; without marker carrier; Blue conductor entry upper deck; for DIN-rail 35 x 15 and 35 x 7.5; 1 mm<sup>2</sup>; Push-in CAGE CLAMP®; 1,00 mm<sup>2</sup>; gray

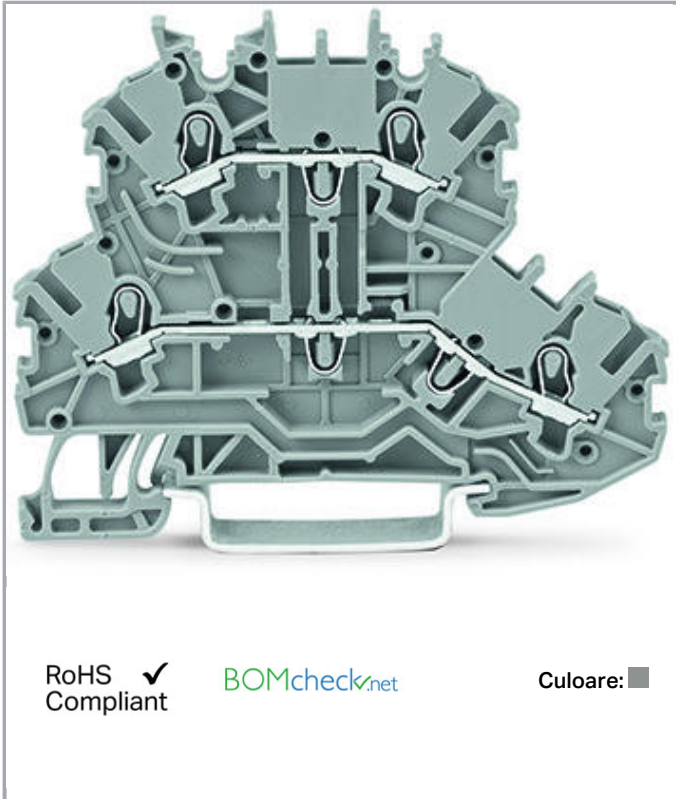

[www.wago.com/2000-2203](http://www.wago.com/2000-2203)



RoHS  Compliant

[BOMcheck.net](https://www.bomcheck.net)

Culoare: ■

### Date

#### Electrical data

#### Ratings per IEC/EN 60664-1

Ratings per	IEC/EN 60947-7-1
Nominal voltage (III/3)	500 V
Rated surge voltage (III/3)	6 kV
Rated current	13,5 A
Rated current 2	16 A
Legend (ratings)	(III / 3) ≙ Overvoltage category III / Pollution degree 3

#### Approvals per UL 1059

Rated voltage UL (Use Group B)	300 V
--------------------------------	-------

Supus modificărilor.

WAGO Kontakttechnik GmbH & Co. KG  
/Representative Office Romania  
Sos. Pipera-Tunari nr. 1/1  
building 1, 2nd floor | 077190 Voluntari, Ilfov  
Tel.: +40-(0)31 421 85 68 | Email: info-RO@wago.com

Aveți întrebări despre produsele noastre?  
Vă stăm la dispoziție pentru preluarea apelului la +40 (0) 31 421 85 68.



Rated current UL (Use Group B)	15 A
Rated voltage UL (Use Group C)	300 V
Rated current UL (Use Group C)	15 A
Approvals per	UL 1059

### Approvals per CSA

Rated voltage CSA (Use Group B)	600 V
Rated current CSA (Use Group B)	10 A
Rated voltage CSA (Use Group C)	600 V
Rated current CSA (Use Group C)	10 A

### Connection data

Connection technology	Push-in CAGE CLAMP®
Number of connection points (connection type)	2
Actuation type	Push-in Open Tool Slot
Connectable conductor materials	Copper
Nominal cross-section	1 mm <sup>2</sup>
Solid conductor	0,14 ... 1,5 mm <sup>2</sup> / 24 ... 16 AWG
Solid conductor; push-in termination	0,5 ... 1,5 mm <sup>2</sup> / 20 ... 16 AWG
Fine-stranded conductor	0,14 ... 1,5 mm <sup>2</sup> / 24 ... 16 AWG
Fine-stranded conductor; with insulated ferrule	0,5 ... 0,75 mm <sup>2</sup> / 20 ... 18 AWG
Fine-stranded conductor; with ferrule; push-in termination	0,5 ... 0,75 mm <sup>2</sup> / 20 ... 18 AWG
Strip length	9 ... 11 mm / 0.35 ... 0.43 inch
Number of connection points	2
Total number of connection points	4
Total number of potentials	2
Number of levels	2
Wiring type	Front-entry wiring
Note (conductor cross-section)	Depending on the conductor characteristic, a conductor with a smaller cross-section can also be inserted via push-in termination.

### Geometrical Data

Width	3,5 mm / 0.138 inch
Height from upper-edge of DIN-rail	51,7 mm / 2.035 inch
Depth	69,7 mm / 2.744 inch

Supus modificărilor.

WAGO Kontakttechnik GmbH & Co. KG  
/Representative Office Romania  
Sos. Pipera-Tunari nr. 1/1  
building 1, 2nd floor | 077190 Voluntari, Ilfov  
Tel.: +40-(0)31 421 85 68 | Email: info-RO@wago.com

Aveți întrebări despre produsele noastre?  
Vă stăm la dispoziție pentru preluarea apelului la +40 (0) 31 421 85 68.

## Mechanical data

Design	horizontal type
Mounting type	DIN-35 rail
Potential marking	L/N
Marking level	Center/side marking

## Material Data

Color	gray
Insulation material	Polyamide 66 (PA 66)
Fire load	0,152 MJ
Weight	7,1 g

## Commercial data

Product Group	22 (TOPJOB S)
Packaging type	BOX
Country of origin	CN
GTIN	4055143267717
Customs tariff number	85369010000

## Aprobări / certificate

### Ex-Approvals



Emblemă	Aprobare	Text de aprobare suplimentar	Nume certificat
	<b>AEx</b> Underwriters Laboratories Inc.	UL 60079	E185892
	<b>ATEX</b> Physikalisch Technische Bundesanstalt	EN 60079	PTB 11 ATEX 1041 U (II 2 G Ex e IIC GB / I M 2 Ex e I Mb)

### Country specific Approvals

Emblemă	Aprobare	Text de aprobare suplimentar	Nume certificat
	<b>CCA</b> DEKRA Certification B.V.	EN 60947	NTR NL 7671

Supus modificărilor.



CCA

	CCA DEKRA Certification B.V.	EN 60947	71- 102841
	CSA DEKRA Certification B.V.	C22.2 No. 158	2130762



## Counterpart

## Produse compatibile

## End plate

	Nr. articol: 2000-2291 End and intermediate plate; 0.7 mm thick; gray	<a href="http://www.wago.com/2000-2291">www.wago.com/2000-2291</a>
	Nr. articol: 2000-2292 End and intermediate plate; 0.7 mm thick; orange	<a href="http://www.wago.com/2000-2292">www.wago.com/2000-2292</a>















## Jumper

	Nr. articol: 2000-402 Push-in type jumper bar; insulated; 2-way; Nominal current 14 A; light gray	<a href="http://www.wago.com/2000-402">www.wago.com/2000-402</a>
	Nr. articol: 2000-402/000-005 Push-in type jumper bar; insulated; 2-way; Nominal current 14 A; red	<a href="http://www.wago.com/2000-402/000-005">www.wago.com/2000-402/000-005</a>
	Nr. articol: 2000-402/000-006 Push-in type jumper bar; insulated; 2-way; Nominal current 14 A; blue	<a href="http://www.wago.com/2000-402/000-006">www.wago.com/2000-402/000-006</a>

## Supus modificărilor.

WAGO Kontakttechnik GmbH & Co. KG  
/Representative Office Romania  
Sos. Pipera-Tunari nr. 1/1  
building 1, 2nd floor | 077190 Voluntari, Ilfov  
Tel.: +40-(0)31 421 85 68 | Email: info-RO@wago.com

Aveți întrebări despre produsele noastre?  
Vă stăm la dispoziție pentru preluarea apelului la +40 (0) 31 421 85 68.

	<b>Nr. articol: 2000-402/000-018</b> Push-in type jumper bar; insulated; 2-way; Nominal current 14 A; yellow-green	<a href="http://www.wago.com/2000-402/000-018">www.wago.com/2000-402/000-018</a>
	<b>Nr. articol: 2000-403</b> Push-in type jumper bar; insulated; 3-way; Nominal current 14 A; light gray	<a href="http://www.wago.com/2000-403">www.wago.com/2000-403</a>
	<b>Nr. articol: 2000-403/000-005</b> Push-in type jumper bar; insulated; 3-way; Nominal current 14 A; red	<a href="http://www.wago.com/2000-403/000-005">www.wago.com/2000-403/000-005</a>
	<b>Nr. articol: 2000-403/000-006</b> Push-in type jumper bar; insulated; 3-way; Nominal current 14 A; blue	<a href="http://www.wago.com/2000-403/000-006">www.wago.com/2000-403/000-006</a>
	<b>Nr. articol: 2000-404</b> Push-in type jumper bar; insulated; 4-way; Nominal current 14 A; light gray	<a href="http://www.wago.com/2000-404">www.wago.com/2000-404</a>
	<b>Nr. articol: 2000-404/000-005</b> Push-in type jumper bar; insulated; 4-way; Nominal current 14 A; red	<a href="http://www.wago.com/2000-404/000-005">www.wago.com/2000-404/000-005</a>
	<b>Nr. articol: 2000-404/000-006</b> Push-in type jumper bar; insulated; 4-way; Nominal current 14 A; blue	<a href="http://www.wago.com/2000-404/000-006">www.wago.com/2000-404/000-006</a>
	<b>Nr. articol: 2000-405</b> Push-in type jumper bar; insulated; 5-way; Nominal current 14 A; light gray	<a href="http://www.wago.com/2000-405">www.wago.com/2000-405</a>
	<b>Nr. articol: 2000-405/000-005</b> Push-in type jumper bar; insulated; 5-way; Nominal current 14 A; red	<a href="http://www.wago.com/2000-405/000-005">www.wago.com/2000-405/000-005</a>
	<b>Nr. articol: 2000-405/000-006</b> Push-in type jumper bar; insulated; 5-way; Nominal current 14 A; blue	<a href="http://www.wago.com/2000-405/000-006">www.wago.com/2000-405/000-006</a>
	<b>Nr. articol: 2000-405/011-000</b> Star point jumper; insulated; 3-way (1-3-5); IN = IN terminal block; light gray	<a href="http://www.wago.com/2000-405/011-000">www.wago.com/2000-405/011-000</a>
	<b>Nr. articol: 2000-406</b> Push-in type jumper bar; insulated; 6-way; Nominal current 14 A; light gray	<a href="http://www.wago.com/2000-406">www.wago.com/2000-406</a>
	<b>Nr. articol: 2000-406/000-005</b> Push-in type jumper bar; insulated; 6-way; Nominal current 14 A; red	<a href="http://www.wago.com/2000-406/000-005">www.wago.com/2000-406/000-005</a>
	<b>Nr. articol: 2000-406/000-006</b> Push-in type jumper bar; insulated; 6-way; Nominal current 14 A; blue	<a href="http://www.wago.com/2000-406/000-006">www.wago.com/2000-406/000-006</a>

Supus modificărilor.

**Nr. articol: 2000-406/020-000**

Delta jumper; insulated; 1-2 3-4 5-6; IN = IN terminal block; light gray

[www.wago.com/2000-406/020-000](http://www.wago.com/2000-406/020-000)**Nr. articol: 2000-407**

Push-in type jumper bar; insulated; 7-way; Nominal current 14 A; light gray

[www.wago.com/2000-407](http://www.wago.com/2000-407)**Nr. articol: 2000-407/000-005**

Push-in type jumper bar; insulated; 7-way; Nominal current 14 A; red

[www.wago.com/2000-407/000-005](http://www.wago.com/2000-407/000-005)**Nr. articol: 2000-407/000-006**

Push-in type jumper bar; insulated; 7-way; Nominal current 14 A; blue

[www.wago.com/2000-407/000-006](http://www.wago.com/2000-407/000-006)**Nr. articol: 2000-408**

Push-in type jumper bar; insulated; 8-way; Nominal current 14 A; light gray

[www.wago.com/2000-408](http://www.wago.com/2000-408)**Nr. articol: 2000-408/000-005**

Push-in type jumper bar; insulated; 8-way; Nominal current 14 A; red

[www.wago.com/2000-408/000-005](http://www.wago.com/2000-408/000-005)**Nr. articol: 2000-408/000-006**

Push-in type jumper bar; insulated; 8-way; Nominal current 14 A; blue

[www.wago.com/2000-408/000-006](http://www.wago.com/2000-408/000-006)**Nr. articol: 2000-409**

Push-in type jumper bar; insulated; 9-way; Nominal current 14 A; light gray

[www.wago.com/2000-409](http://www.wago.com/2000-409)**Nr. articol: 2000-409/000-005**

Push-in type jumper bar; insulated; 9-way; Nominal current 14 A; red

[www.wago.com/2000-409/000-005](http://www.wago.com/2000-409/000-005)**Nr. articol: 2000-409/000-006**

Push-in type jumper bar; insulated; 9-way; Nominal current 14 A; blue

[www.wago.com/2000-409/000-006](http://www.wago.com/2000-409/000-006)**Nr. articol: 2000-410**

Push-in type jumper bar; insulated; 10-way; Nominal current 14 A; light gray

[www.wago.com/2000-410](http://www.wago.com/2000-410)**Nr. articol: 2000-410/000-005**

Push-in type jumper bar; insulated; 10-way; Nominal current 14 A; red

[www.wago.com/2000-410/000-005](http://www.wago.com/2000-410/000-005)**Nr. articol: 2000-410/000-006**

Push-in type jumper bar; insulated; 10-way; Nominal current 14 A; blue

[www.wago.com/2000-410/000-006](http://www.wago.com/2000-410/000-006)**Nr. articol: 2000-433**

















Push-in type jumper bar; insulated; from 1 to 3; Nominal current 14 A; light gray

[www.wago.com/2000-433](http://www.wago.com/2000-433)**Nr. articol: 2000-433/000-005**

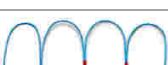















Push-in type jumper bar; insulated; from 1 to 3; Nominal current 14 A; red

[www.wago.com/2000-433/000-005](http://www.wago.com/2000-433/000-005)

Supus modificărilor.















	<b>Nr. articol: 2000-433/000-006</b> Push-in type jumper bar; insulated; from 1 to 3; Nominal current 14 A; blue	<a href="http://www.wago.com/2000-433/000-006">www.wago.com/2000-433/000-006</a>
	<b>Nr. articol: 2000-434</b> Push-in type jumper bar; insulated; from 1 to 4; Nominal current 14 A; light gray	<a href="http://www.wago.com/2000-434">www.wago.com/2000-434</a>
	<b>Nr. articol: 2000-435</b> Push-in type jumper bar; insulated; from 1 to 5; Nominal current 14 A; light gray	<a href="http://www.wago.com/2000-435">www.wago.com/2000-435</a>
	<b>Nr. articol: 2000-436</b> Push-in type jumper bar; insulated; from 1 to 6; Nominal current 14 A; light gray	<a href="http://www.wago.com/2000-436">www.wago.com/2000-436</a>
	<b>Nr. articol: 2000-437</b> Push-in type jumper bar; insulated; from 1 to 7; Nominal current 14 A; light gray	<a href="http://www.wago.com/2000-437">www.wago.com/2000-437</a>
	<b>Nr. articol: 2000-438</b> Push-in type jumper bar; insulated; from 1 to 8; Nominal current 14 A; light gray	<a href="http://www.wago.com/2000-438">www.wago.com/2000-438</a>
	<b>Nr. articol: 2000-439</b> Push-in type jumper bar; insulated; from 1 to 9; Nominal current 14 A; light gray	<a href="http://www.wago.com/2000-439">www.wago.com/2000-439</a>
	<b>Nr. articol: 2000-440</b> Push-in type jumper bar; insulated; from 1 to 10; Nominal current 14 A; light gray	<a href="http://www.wago.com/2000-440">www.wago.com/2000-440</a>
	<b>Nr. articol: 2000-492</b> Double-deck vertical jumper; insulated; light gray	<a href="http://www.wago.com/2000-492">www.wago.com/2000-492</a>
	<b>Nr. articol: 210-103</b> Wire commoning chain; insulated; 50 connections; black	<a href="http://www.wago.com/210-103">www.wago.com/210-103</a>
	<b>Nr. articol: 210-123</b> Wire commoning chain; insulated; 50 connections	<a href="http://www.wago.com/210-123">www.wago.com/210-123</a>
<b>Push-In type wire jumper</b>		
	<b>Nr. articol: 2009-402</b> Push-in type wire jumper; insulated; wire length 60 mm; Conductor cross section 0.75 mm <sup>2</sup> ; suitable for 2000 and 2020 Series rail-mounted terminal blocks; gray	<a href="http://www.wago.com/2009-402">www.wago.com/2009-402</a>
	<b>Nr. articol: 2009-404</b> Push-in type wire jumper; insulated; wire length 110 mm; Conductor cross section 0.75 mm <sup>2</sup> ; suitable for 2000 and 2020 Series rail-mounted terminal blocks; gray	<a href="http://www.wago.com/2009-404">www.wago.com/2009-404</a>
	<b>Nr. articol: 2009-406</b> Push-in type wire jumper; insulated; wire length 250 mm; Conductor cross section 0.75 mm <sup>2</sup> ; suitable for 2000 and 2020 Series rail-mounted terminal blocks; gray	<a href="http://www.wago.com/2009-406">www.wago.com/2009-406</a>
<b>check</b>		
	<b>Nr. articol: 2000-510</b> TOPJOB®S L-type test plug module; modular; for jumper contact slot; 1,00 mm <sup>2</sup> ; gray	<a href="http://www.wago.com/2000-510">www.wago.com/2000-510</a>
	<b>Nr. articol: 2000-511</b> TOPJOB®S L-type test plug module; modular; for jumper contact slot; 1-pole; 1,00 mm <sup>2</sup> ; gray	<a href="http://www.wago.com/2000-511">www.wago.com/2000-511</a>

Supus modificărilor.

	<b>Nr. articol: 2000-549</b> Spacer module; modular; e.g., for bridging commoned terminal blocks; gray	<a href="http://www.wago.com/2000-549">www.wago.com/2000-549</a>
	<b>Nr. articol: 2000-552</b> Modular TOPJOB®S connector; modular; for jumper contact slot; 2-pole; 1,00 mm <sup>2</sup> ; gray	<a href="http://www.wago.com/2000-552">www.wago.com/2000-552</a>
	<b>Nr. articol: 2000-553</b> Modular TOPJOB®S connector; modular; for jumper contact slot; 3-pole; 1,00 mm <sup>2</sup> ; gray	<a href="http://www.wago.com/2000-553">www.wago.com/2000-553</a>
	<b>Nr. articol: 2000-554</b> Modular TOPJOB®S connector; modular; for jumper contact slot; 4-pole; 1,00 mm <sup>2</sup> ; gray	<a href="http://www.wago.com/2000-554">www.wago.com/2000-554</a>
	<b>Nr. articol: 2000-555</b> Modular TOPJOB®S connector; modular; for jumper contact slot; 5-pole; 1,00 mm <sup>2</sup> ; gray	<a href="http://www.wago.com/2000-555">www.wago.com/2000-555</a>
	<b>Nr. articol: 2000-556</b> Modular TOPJOB®S connector; modular; for jumper contact slot; 6-pole; 1,00 mm <sup>2</sup> ; gray	<a href="http://www.wago.com/2000-556">www.wago.com/2000-556</a>
	<b>Nr. articol: 2000-557</b> Modular TOPJOB®S connector; modular; for jumper contact slot; 7-pole; 1,00 mm <sup>2</sup> ; gray	<a href="http://www.wago.com/2000-557">www.wago.com/2000-557</a>
	<b>Nr. articol: 2000-558</b> Modular TOPJOB®S connector; modular; for jumper contact slot; 8-pole; 1,00 mm <sup>2</sup> ; gray	<a href="http://www.wago.com/2000-558">www.wago.com/2000-558</a>
	<b>Nr. articol: 2000-559</b> Modular TOPJOB®S connector; modular; for jumper contact slot; 9-pole; 1,00 mm <sup>2</sup> ; gray	<a href="http://www.wago.com/2000-559">www.wago.com/2000-559</a>
	<b>Nr. articol: 2000-560</b> Modular TOPJOB®S connector; modular; for jumper contact slot; 10-pole; 1,00 mm <sup>2</sup> ; gray	<a href="http://www.wago.com/2000-560">www.wago.com/2000-560</a>
	<b>Nr. articol: 2009-174</b> Test plug adapter; for 4 mm Ø test plugs; for testing TOPJOB®S rail-mounted terminal blocks; gray	<a href="http://www.wago.com/2009-174">www.wago.com/2009-174</a>
	<b>Nr. articol: 2009-182</b> Testing tap; for max. 2.5 mm <sup>2</sup> ; tool-free connection for individual test wires 0.08 - 2.5 mm; gray	<a href="http://www.wago.com/2009-182">www.wago.com/2009-182</a>
	<b>Nr. articol: 210-136</b> Test plug; 2 mm Ø; with 500 mm cable; red	<a href="http://www.wago.com/210-136">www.wago.com/210-136</a>
	<b>Nr. articol: 210-137</b> Test plug; 2.3 mm Ø; with 500 mm cable; yellow	<a href="http://www.wago.com/210-137">www.wago.com/210-137</a>
<b>Carrier rail</b>		
	<b>Nr. articol: 210-112</b> Steel carrier rail; 35 x 7.5 mm; 1 mm thick; 2 m long; slotted; according to EN 60715; "Hole width 25 mm	<a href="http://www.wago.com/210-112">www.wago.com/210-112</a>
	<b>Nr. articol: 210-113</b> Steel carrier rail; 35 x 7.5 mm; 1 mm thick; 2 m long; unslotted; according to EN 60715	<a href="http://www.wago.com/210-113">www.wago.com/210-113</a>
	<b>Nr. articol: 210-114</b> Steel carrier rail; 35 x 15 mm; 1.5 mm thick; 2 m long; unslotted; similar to EN 60715	<a href="http://www.wago.com/210-114">www.wago.com/210-114</a>
	<b>Nr. articol: 210-115</b>	

Supus modificărilor.



	Steel carrier rail; 35 x 7.5 mm; 1 mm thick; 2 m long; slotted; according to EN 60715; "Hole width 18 mm	<a href="http://www.wago.com/210-115">www.wago.com/210-115</a>
	<b>Nr. articol: 210-118</b> Steel carrier rail; 35 x 15 mm; 2.3 mm thick; 2 m long; unslotted; according to EN 60715	<a href="http://www.wago.com/210-118">www.wago.com/210-118</a>
	<b>Nr. articol: 210-196</b> Aluminum carrier rail; 35 x 8.2 mm; 1.6 mm thick; 2 m long; unslotted; similar to EN 60715; silver-colored	<a href="http://www.wago.com/210-196">www.wago.com/210-196</a>
	<b>Nr. articol: 210-197</b> Steel carrier rail; 35 x 15 mm; 1.5 mm thick; 2 m long; slotted; similar to EN 60715	<a href="http://www.wago.com/210-197">www.wago.com/210-197</a>
	<b>Nr. articol: 210-198</b> Copper carrier rail; 35 x 15 mm; 2.3 mm thick; 2 m long; unslotted; according to EN 60715; copper-colored	<a href="http://www.wago.com/210-198">www.wago.com/210-198</a>
<b>tools</b>		
	<b>Nr. articol: 210-647</b> Operating tool; Blade: 2.5 x 0.4 mm; with a partially insulated shaft	<a href="http://www.wago.com/210-647">www.wago.com/210-647</a>
	<b>Nr. articol: 210-648</b> Operating tool; Blade: 2.5 x 0.4 mm; with a partially insulated shaft; angled; short	<a href="http://www.wago.com/210-648">www.wago.com/210-648</a>
	<b>Nr. articol: 210-719</b> Operating tool; Blade: 2.5 x 0.4 mm; with a partially insulated shaft	<a href="http://www.wago.com/210-719">www.wago.com/210-719</a>
<b>Marking accessories</b>		
	<b>Nr. articol: 2000-121</b> Adaptor	<a href="http://www.wago.com/2000-121">www.wago.com/2000-121</a>
	<b>Nr. articol: 2009-110</b> Marking strips; on reel; not stretchable; plain; snap-on type; white	<a href="http://www.wago.com/2009-110">www.wago.com/2009-110</a>
	<b>Nr. articol: 2009-113</b> WMB-Inline; for Smart Printer; 2300 pieces on roll; plain; snap-on type; white	<a href="http://www.wago.com/2009-113">www.wago.com/2009-113</a>
	<b>Nr. articol: 2009-113/000-002</b> WMB-Inline; for Smart Printer; 2300 pieces on roll; plain; snap-on type; yellow	<a href="http://www.wago.com/2009-113/000-002">www.wago.com/2009-113/000-002</a>
	<b>Nr. articol: 2009-113/000-005</b> WMB-Inline; for Smart Printer; 2300 pieces on roll; plain; snap-on type; red	<a href="http://www.wago.com/2009-113/000-005">www.wago.com/2009-113/000-005</a>
	<b>Nr. articol: 2009-113/000-006</b> WMB-Inline; for Smart Printer; 2300 pieces on roll; plain; snap-on type; blue	<a href="http://www.wago.com/2009-113/000-006">www.wago.com/2009-113/000-006</a>
	<b>Nr. articol: 2009-113/000-007</b> WMB-Inline; for Smart Printer; 2300 pieces on roll; plain; snap-on type; gray	<a href="http://www.wago.com/2009-113/000-007">www.wago.com/2009-113/000-007</a>

Supus modificărilor.

	<b>Nr. articol: 2009-113/000-012</b> WMB-Inline; for Smart Printer; 2300 pieces on roll; plain; snap-on type; orange	<a href="http://www.wago.com/2009-113/000-012">www.wago.com/2009-113/000-012</a>
	<b>Nr. articol: 2009-113/000-017</b> WMB-Inline; for Smart Printer; 2300 pieces on roll; plain; snap-on type; light green	<a href="http://www.wago.com/2009-113/000-017">www.wago.com/2009-113/000-017</a>
	<b>Nr. articol: 2009-113/000-023</b> WMB-Inline; for Smart Printer; 2300 pieces on roll; plain; snap-on type; green	<a href="http://www.wago.com/2009-113/000-023">www.wago.com/2009-113/000-023</a>
	<b>Nr. articol: 2009-113/000-024</b> WMB-Inline; for Smart Printer; 2300 pieces on roll; plain; snap-on type; violet	<a href="http://www.wago.com/2009-113/000-024">www.wago.com/2009-113/000-024</a>
	<b>Nr. articol: 793-3501</b> WMB marking card; as card; plain; snap-on type; white	<a href="http://www.wago.com/793-3501">www.wago.com/793-3501</a>
<b>ferrule</b>		
	<b>Nr. articol: 216-241</b> Ferrule; Sleeve for 0.5 mm <sup>2</sup> / 20 AWG; insulated; electro-tin plated; electrolytic copper; gastight crimped; acc. to DIN 46228, Part 4/09.90; white	<a href="http://www.wago.com/216-241">www.wago.com/216-241</a>
	<b>Nr. articol: 216-242</b> Ferrule; Sleeve for 0.75 mm <sup>2</sup> / 18 AWG; insulated; electro-tin plated; electrolytic copper; gastight crimped; acc. to DIN 46228, Part 4/09.90; gray	<a href="http://www.wago.com/216-242">www.wago.com/216-242</a>
	<b>Nr. articol: 216-243</b> Ferrule; Sleeve for 1 mm <sup>2</sup> / AWG 18; insulated; electro-tin plated; electrolytic copper; gastight crimped; acc. to DIN 46228, Part 4/09.90; red	<a href="http://www.wago.com/216-243">www.wago.com/216-243</a>
<b>Protective Warning Marker</b>		
	<b>Nr. articol: 2000-115</b> Protective warning marker; with high-voltage symbol, black; for 5 terminal blocks; yellow	<a href="http://www.wago.com/2000-115">www.wago.com/2000-115</a>

## Descărcări

### Documentation

#### Additional Information

Technical explanations	Apr 3, 2019	pdf 2,1 MB	Descărcare
------------------------	-------------	---------------	------------

### CAD/CAE-Data

#### CAD data

2D/3D Models 2000-2203	URL	Descărcare
------------------------	-----	------------

#### CAE data

Supus modificărilor.

WAGO Kontakttechnik GmbH & Co. KG  
/Representative Office Romania  
Sos. Pipera-Tunari nr. 1/1  
building 1, 2nd floor | 077190 Voluntari, Ilfov  
Tel.: +40-(0)31 421 85 68 | Email: info-RO@wago.com

Aveți întrebări despre produsele noastre?  
Vă stăm la dispoziție pentru preluarea apelului la +40 (0) 31 421 85 68.

## Installation Notes

### Conductor termination

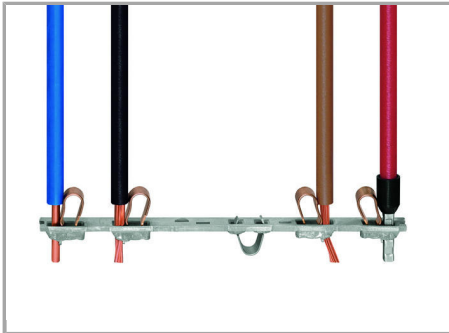

All conductor types at a glance

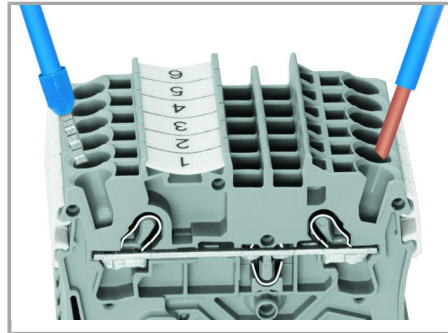

Terminating solid and ferruled conductors via push-in connection.

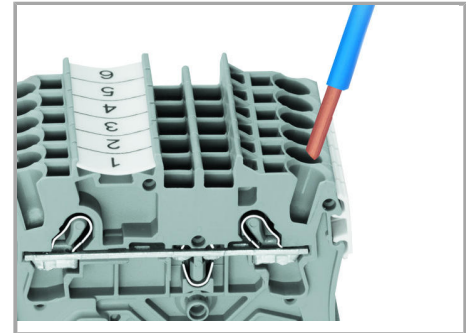

Inserting conductors via push-in termination.

**Solid conductors** with cross-sections from either one size above, or up to two sizes below, the rated cross-section can be simply pushed in – no tools needed.

Supus modificărilor.

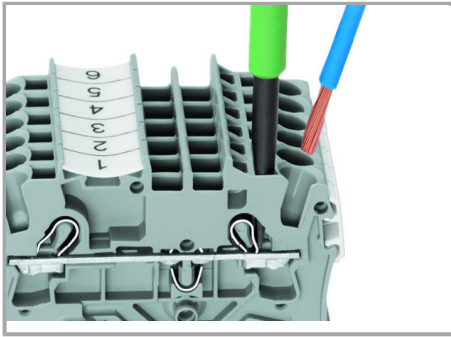

Inserting a conductor via operating tool.

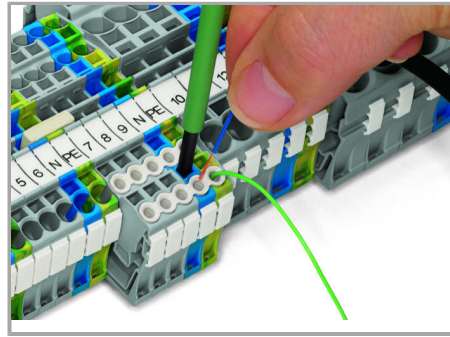

Conductor termination – Insulation stop.

Connecting fine-stranded conductors without ferrules, or small cross-sectional conductors that cannot be pushed in, is performed similarly to the original CAGE CLAMP® – just use an operating tool.

#### The smart feature:

To open the clamp, the operating tool is inserted vertically. The conductor entry is less than 15 degrees for easier wiring.

#### Marking

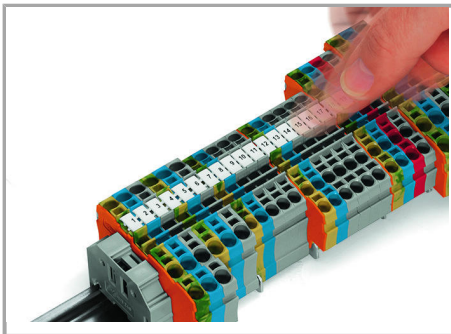

Snapping WMB Inline markers into marker slots.

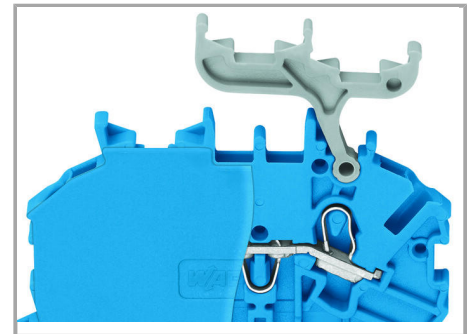
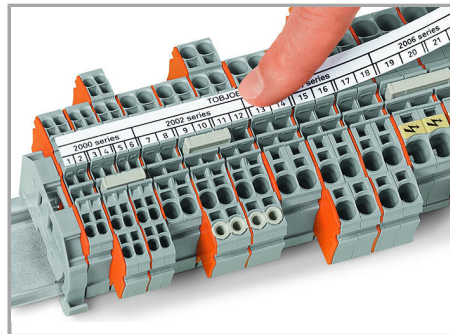

#### Double-Deck Terminal Blocks

A double-deck marker carrier (2000-121) can be retrofitted to double-deck terminal blocks without a marker carrier.

Supus modificărilor.



## Familie de produse

### TOPJOB® S

TOPJOB® S: In various industrial applications and modern building installations, WAGO's wide and versatile range of rail-mount terminal blocks provides more than just reliable electrical connections.

[Afișare globală produse din familie.](#)

Supus modificărilor.

---

WAGO Kontakttechnik GmbH & Co. KG  
/Representative Office Romania  
Sos. Pipera-Tunari nr. 1/1  
building 1, 2nd floor | 077190 Voluntari, Ilfov  
Tel.: +40-(0)31 421 85 68 | Email: [info-RO@wago.com](mailto:info-RO@wago.com)

Aveți întrebări despre produsele noastre?  
Vă stăm la dispoziție pentru preluarea apelului la +40 (0) 31 421 85 68.