

Fișă tehnică | Număr articol: 270-577

3-conductor sensor/actuator terminal block; with colored conductor entries;  
2.5 mm<sup>2</sup>; CAGE CLAMP®; 2,50 mm<sup>2</sup>; orange

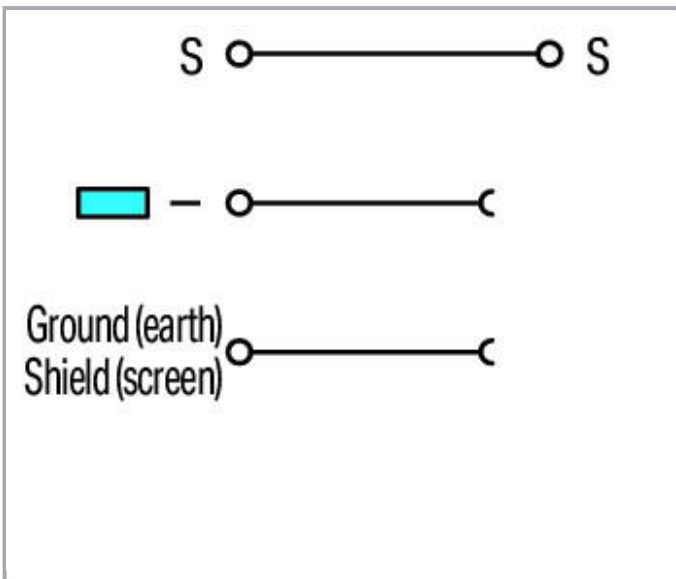

[www.wago.com/270-577](http://www.wago.com/270-577)

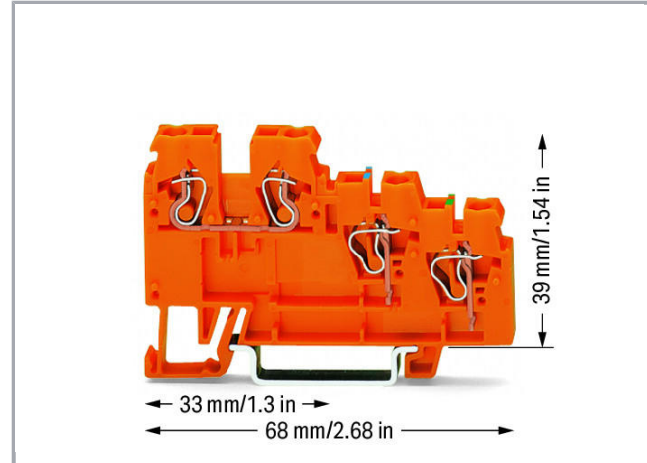
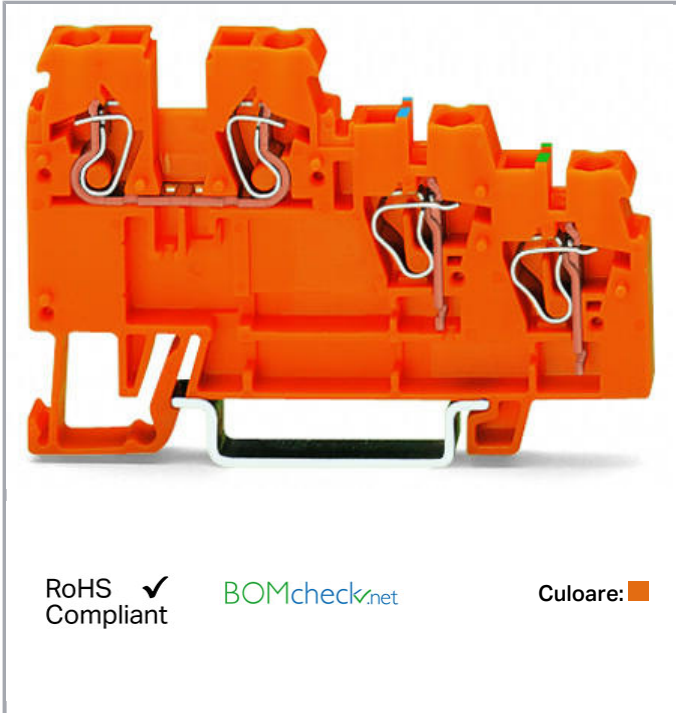

Date

Supus modificărilor.

WAGO Kontakttechnik GmbH & Co. KG  
/Representative Office Romania  
Sos. Pipera-Tunari nr. 1/1  
building 1, 2nd floor | 077190 Voluntari, Ilfov  
Tel.: +40-(0)31 421 85 68 | Email: info-RO@wago.com

Aveți întrebări despre produsele noastre?  
Vă stăm la dispoziție pentru preluarea apelului la +40 (0) 31 421 85 68.



## Electrical data

### Ratings per IEC/EN 60664-1

Nominal voltage (III/3)	250 V
Rated surge voltage (III/3)	4 kV
Rated current	18 A
Legend (ratings)	(III / 3) $\triangleq$ Overvoltage category III / Pollution degree 3

## Connection data

Connection technology	CAGE CLAMP®
Actuation type	Operating tool
Connectable conductor materials	Copper
Solid conductor	0,08 ... 2,5 mm <sup>2</sup> / 28 ... 12 AWG
Fine-stranded conductor	0,08 ... 2,5 mm <sup>2</sup> / 28 ... 12 AWG
Strip length	6 ... 7 mm / 0.24 ... 0.28 inch
Total number of connection points	4
Total number of potentials	3
Number of levels	3
Wiring type	Front-entry wiring
Note (conductor cross-section)	12 AWG: THHN, THWN

## Geometrical Data

Width	5 mm / 0.197 inch
Height from upper-edge of DIN-rail	39 mm / 1.535 inch
Depth	68 mm / 2.677 inch

## Mechanical data

Design	horizontal type
Mounting type	DIN-35 rail
Marking level	Side marking

## Material Data

Color	orange
Fire load	0,172 MJ
Weight	8,9 g



Supus modificărilor.

## Commercial data

Product Group	1 (Rail Mounted Terminal Blocks)
Packaging type	BOX
Country of origin	CN
GTIN	4050821035275
Customs tariff number	85369010000

## Aprobări / certificate

### Country specific Approvals

Emblemă	Aprobare	Text de aprobare suplimentar	Nume certificat
	CCA DEKRA Certification B.V.	EN 60947	2143311.03
	CCA DEKRA Certification B.V.	EN 60947	NTR NL 6828
	CSA DEKRA Certification B.V.	C22.2	1565649

### UL-Approvals

Emblemă	Aprobare	Text de aprobare suplimentar	Nume certificat
	UR Underwriters Laboratories Inc.	UL 1059	20190731- E45172

## Counterpart













## Produse compatibile

Supus modificărilor.

WAGO Kontakttechnik GmbH & Co. KG  
/Representative Office Romania  
Sos. Pipera-Tunari nr. 1/1  
building 1, 2nd floor | 077190 Voluntari, Ilfov  
Tel.: +40-(0)31 421 85 68 | Email: info-RO@wago.com

Aveți întrebări despre produsele noastre?  
Vă stăm la dispoziție pentru preluarea apelului la +40 (0) 31 421 85 68.















## Marking accessories

	<b>Nr. articol: 2009-115</b> WMB-Inline; for Smart Printer; 1500 pieces on roll; stretchable 5 - 5.2 mm; plain; snap-on type; white	<a href="http://www.wago.com/2009-115">www.wago.com/2009-115</a>
	<b>Nr. articol: 2009-115/000-002</b> WMB-Inline; for Smart Printer; 1500 pieces on roll; stretchable 5 - 5.2 mm; plain; snap-on type; yellow	<a href="http://www.wago.com/2009-115/000-002">www.wago.com/2009-115/000-002</a>
	<b>Nr. articol: 2009-115/000-006</b> WMB-Inline; for Smart Printer; 1500 pieces on roll; stretchable 5 - 5.2 mm; plain; snap-on type; blue	<a href="http://www.wago.com/2009-115/000-006">www.wago.com/2009-115/000-006</a>
	<b>Nr. articol: 2009-115/000-007</b> WMB-Inline; for Smart Printer; 1500 pieces on roll; stretchable 5 - 5.2 mm; plain; snap-on type; gray	<a href="http://www.wago.com/2009-115/000-007">www.wago.com/2009-115/000-007</a>
	<b>Nr. articol: 2009-115/000-012</b> WMB-Inline; for Smart Printer; 1500 pieces on roll; stretchable 5 - 5.2 mm; plain; snap-on type; orange	<a href="http://www.wago.com/2009-115/000-012">www.wago.com/2009-115/000-012</a>
	<b>Nr. articol: 2009-115/000-017</b> WMB-Inline; for Smart Printer; 1500 pieces on roll; stretchable 5 - 5.2 mm; plain; snap-on type; light green	<a href="http://www.wago.com/2009-115/000-017">www.wago.com/2009-115/000-017</a>
	<b>Nr. articol: 2009-115/000-023</b> WMB-Inline; for Smart Printer; 1500 pieces on roll; stretchable 5 - 5.2 mm; plain; snap-on type; green	<a href="http://www.wago.com/2009-115/000-023">www.wago.com/2009-115/000-023</a>
	<b>Nr. articol: 2009-115/000-024</b> WMB-Inline; for Smart Printer; 1500 pieces on roll; stretchable 5 - 5.2 mm; plain; snap-on type; violet	<a href="http://www.wago.com/2009-115/000-024">www.wago.com/2009-115/000-024</a>
	<b>Nr. articol: 2009-145</b> Mini-WSB Inline; for Smart Printer; 1700 pieces on roll; stretchable 5 - 5.2 mm; plain; snap-on type; white	<a href="http://www.wago.com/2009-145">www.wago.com/2009-145</a>
	<b>Nr. articol: 2009-145/000-002</b> Mini-WSB Inline; for Smart Printer; 1700 pieces on roll; stretchable 5 - 5.2 mm; plain; snap-on type; yellow	<a href="http://www.wago.com/2009-145/000-002">www.wago.com/2009-145/000-002</a>
	<b>Nr. articol: 2009-145/000-005</b> Mini-WSB Inline; for Smart Printer; 1700 pieces on roll; stretchable 5 - 5.2 mm; plain; snap-on type; red	<a href="http://www.wago.com/2009-145/000-005">www.wago.com/2009-145/000-005</a>
	<b>Nr. articol: 2009-145/000-006</b> Mini-WSB Inline; for Smart Printer; 1700 pieces on roll; stretchable 5 - 5.2 mm; plain; snap-on type; blue	<a href="http://www.wago.com/2009-145/000-006">www.wago.com/2009-145/000-006</a>
	<b>Nr. articol: 2009-145/000-007</b> Mini-WSB Inline; for Smart Printer; 1700 pieces on roll; stretchable 5 - 5.2 mm; plain; snap-on type; gray	<a href="http://www.wago.com/2009-145/000-007">www.wago.com/2009-145/000-007</a>















Supus modificărilor.

WAGO Kontakttechnik GmbH & Co. KG  
/Representative Office Romania  
Sos. Pipera-Tunari nr. 1/1  
building 1, 2nd floor | 077190 Voluntari, Ilfov  
Tel.: +40-(0)31 421 85 68 | Email: info-RO@wago.com

Aveți întrebări despre produsele noastre?  
Vă stăm la dispoziție pentru preluarea apelului la +40 (0) 31 421 85 68.

	<p><b>Nr. articol: 2009-145/000-012</b>                  Mini-WSB Inline; for Smart Printer; 1700 pieces on roll; stretchable 5 - 5.2 mm; plain; snap-on type; orange</p>	<a href="http://www.wago.com/2009-145/000-012">www.wago.com/2009-145/000-012</a>
	<p><b>Nr. articol: 2009-145/000-023</b>                  Mini-WSB Inline; for Smart Printer; 1700 pieces on roll; stretchable 5 - 5.2 mm; plain; snap-on type; green</p>	<a href="http://www.wago.com/2009-145/000-023">www.wago.com/2009-145/000-023</a>
	<p><b>Nr. articol: 2009-145/000-024</b>                  Mini-WSB Inline; for Smart Printer; 1700 pieces on roll; stretchable 5 - 5.2 mm; plain; snap-on type; violet</p>	<a href="http://www.wago.com/2009-145/000-024">www.wago.com/2009-145/000-024</a>
	<p><b>Nr. articol: 248-501</b>                  Miniature WSB Quick marking system; plain; Marker width 5 mm; 10 strips with 10 markers per card</p>	<a href="http://www.wago.com/248-501">www.wago.com/248-501</a>
	<p><b>Nr. articol: 248-501/000-002</b>                  Mini-WSB marking card; as card; not stretchable; plain; snap-on type; yellow</p>	<a href="http://www.wago.com/248-501/000-002">www.wago.com/248-501/000-002</a>
	<p><b>Nr. articol: 248-501/000-005</b>                  Mini-WSB marking card; as card; not stretchable; plain; snap-on type; red</p>	<a href="http://www.wago.com/248-501/000-005">www.wago.com/248-501/000-005</a>
	<p><b>Nr. articol: 248-501/000-006</b>                  Mini-WSB marking card; as card; not stretchable; plain; snap-on type; blue</p>	<a href="http://www.wago.com/248-501/000-006">www.wago.com/248-501/000-006</a>
	<p><b>Nr. articol: 248-501/000-007</b>                  Mini-WSB marking card; as card; not stretchable; plain; snap-on type; gray</p>	<a href="http://www.wago.com/248-501/000-007">www.wago.com/248-501/000-007</a>
	<p><b>Nr. articol: 248-501/000-012</b>                  Mini-WSB marking card; as card; not stretchable; plain; snap-on type; orange</p>	<a href="http://www.wago.com/248-501/000-012">www.wago.com/248-501/000-012</a>
	<p><b>Nr. articol: 248-501/000-017</b>                  Mini-WSB marking card; as card; not stretchable; plain; snap-on type; light green</p>	<a href="http://www.wago.com/248-501/000-017">www.wago.com/248-501/000-017</a>
	<p><b>Nr. articol: 248-501/000-023</b>                  Mini-WSB marking card; as card; not stretchable; plain; snap-on type; green</p>	<a href="http://www.wago.com/248-501/000-023">www.wago.com/248-501/000-023</a>
	<p><b>Nr. articol: 248-501/000-024</b>                  Mini-WSB marking card; as card; not stretchable; plain; snap-on type; violet</p>	<a href="http://www.wago.com/248-501/000-024">www.wago.com/248-501/000-024</a>
	<p><b>Nr. articol: 709-177</b>                  Marking strips; on reel; 7.5 mm wide; not stretchable; plain; snap-on type; translucent</p>	<a href="http://www.wago.com/709-177">www.wago.com/709-177</a>
	<p><b>Nr. articol: 709-178</b>                  Marking strips; on reel; 7.5 mm wide; not stretchable; plain; snap-on type; white</p>	<a href="http://www.wago.com/709-178">www.wago.com/709-178</a>

Supus modificărilor.

	<b>Nr. articol: 709-196</b> Marking strips; for laser printer; translucent	<a href="http://www.wago.com/709-196">www.wago.com/709-196</a>
	<b>Nr. articol: 709-198</b> Marking strips; white	<a href="http://www.wago.com/709-198">www.wago.com/709-198</a>
	<b>Nr. articol: 793-501</b> WMB marking card; as card; not stretchable; plain; snap-on type; white	<a href="http://www.wago.com/793-501">www.wago.com/793-501</a>
	<b>Nr. articol: 793-501/000-002</b> WMB marking card; as card; not stretchable; plain; snap-on type; yellow	<a href="http://www.wago.com/793-501/000-002">www.wago.com/793-501/000-002</a>
	<b>Nr. articol: 793-501/000-005</b> WMB marking card; as card; not stretchable; plain; snap-on type; red	<a href="http://www.wago.com/793-501/000-005">www.wago.com/793-501/000-005</a>
	<b>Nr. articol: 793-501/000-006</b> WMB marking card; as card; not stretchable; plain; snap-on type; blue	<a href="http://www.wago.com/793-501/000-006">www.wago.com/793-501/000-006</a>
	<b>Nr. articol: 793-501/000-007</b> WMB marking card; as card; not stretchable; plain; snap-on type; gray	<a href="http://www.wago.com/793-501/000-007">www.wago.com/793-501/000-007</a>
	<b>Nr. articol: 793-501/000-012</b> WMB marking card; as card; not stretchable; plain; snap-on type; orange	<a href="http://www.wago.com/793-501/000-012">www.wago.com/793-501/000-012</a>
	<b>Nr. articol: 793-501/000-017</b> WMB marking card; as card; not stretchable; plain; snap-on type; light green	<a href="http://www.wago.com/793-501/000-017">www.wago.com/793-501/000-017</a>
	<b>Nr. articol: 793-501/000-023</b> WMB marking card; as card; not stretchable; plain; snap-on type; green	<a href="http://www.wago.com/793-501/000-023">www.wago.com/793-501/000-023</a>
	<b>Nr. articol: 793-501/000-024</b> WMB marking card; as card; not stretchable; plain; snap-on type; violet	<a href="http://www.wago.com/793-501/000-024">www.wago.com/793-501/000-024</a>
	<b>Nr. articol: 793-5501</b> WMB marking card; as card; for terminal block width 5 - 17.5 mm; stretchable 5 - 5.2 mm; plain; snap-on type; white	<a href="http://www.wago.com/793-5501">www.wago.com/793-5501</a>
	<b>Nr. articol: 793-5501/000-002</b> WMB marking card; as card; for terminal block width 5 - 17.5 mm; stretchable 5 - 5.2 mm; plain; snap-on type; yellow	<a href="http://www.wago.com/793-5501/000-002">www.wago.com/793-5501/000-002</a>
	<b>Nr. articol: 793-5501/000-005</b> WMB marking card; as card; for terminal block width 5 - 17.5 mm; stretchable 5 - 5.2 mm; plain; snap-on type; red	<a href="http://www.wago.com/793-5501/000-005">www.wago.com/793-5501/000-005</a>
	<b>Nr. articol: 793-5501/000-006</b>	

Supus modificărilor.



WMB marking card; as card; for terminal block width 5 - 17.5 mm; stretchable 5 - 5.2 mm; plain; snap-on type; blue

[www.wago.com/793-5501/000-006](http://www.wago.com/793-5501/000-006)



**Nr. articol: 793-5501/000-007**

WMB marking card; as card; for terminal block width 5 - 17.5 mm; stretchable 5 - 5.2 mm; plain; snap-on type; gray

[www.wago.com/793-5501/000-007](http://www.wago.com/793-5501/000-007)



**Nr. articol: 793-5501/000-012**

WMB marking card; as card; for terminal block width 5 - 17.5 mm; stretchable 5 - 5.2 mm; plain; snap-on type; orange

[www.wago.com/793-5501/000-012](http://www.wago.com/793-5501/000-012)



**Nr. articol: 793-5501/000-017**

WMB marking card; as card; for terminal block width 5 - 17.5 mm; stretchable 5 - 5.2 mm; plain; snap-on type; green

[www.wago.com/793-5501/000-017](http://www.wago.com/793-5501/000-017)



**Nr. articol: 793-5501/000-023**

WMB marking card; as card; for terminal block width 5 - 17.5 mm; stretchable 5 - 5.2 mm; plain; snap-on type; light green

[www.wago.com/793-5501/000-023](http://www.wago.com/793-5501/000-023)



**Nr. articol: 793-5501/000-024**

WMB marking card; as card; for terminal block width 5 - 17.5 mm; stretchable 5 - 5.2 mm; plain; snap-on type; violet

[www.wago.com/793-5501/000-024](http://www.wago.com/793-5501/000-024)

#### End plate



**Nr. articol: 270-321**

End and intermediate plate; 1 mm thick; for triple-deck terminal blocks; orange

[www.wago.com/270-321](http://www.wago.com/270-321)

#### ferrule



**Nr. articol: 216-121**

Ferrule; Sleeve for 0.5 mm<sup>2</sup> / AWG 22; uninsulated; electro-tin plated

[www.wago.com/216-121](http://www.wago.com/216-121)



**Nr. articol: 216-122**

Ferrule; Sleeve for 0.75 mm<sup>2</sup> / AWG 20; uninsulated; electro-tin plated

[www.wago.com/216-122](http://www.wago.com/216-122)



**Nr. articol: 216-123**

Ferrule; Sleeve for 1 mm<sup>2</sup> / AWG 18; uninsulated; electro-tin plated

[www.wago.com/216-123](http://www.wago.com/216-123)



**Nr. articol: 216-124**

Ferrule; Sleeve for 1.5 mm<sup>2</sup> / AWG 16; uninsulated; electro-tin plated

[www.wago.com/216-124](http://www.wago.com/216-124)



**Nr. articol: 216-131**

Ferrule; Sleeve for 0.25 mm<sup>2</sup> / AWG 24; uninsulated; electro-tin plated

[www.wago.com/216-131](http://www.wago.com/216-131)



**Nr. articol: 216-132**

Ferrule; Sleeve for 0.34 mm<sup>2</sup> / AWG 24; uninsulated; electro-tin plated

[www.wago.com/216-132](http://www.wago.com/216-132)



**Nr. articol: 216-221**

Ferrule; Sleeve for 0.5 mm<sup>2</sup> / 20 AWG; insulated; electro-tin plated; white

[www.wago.com/216-221](http://www.wago.com/216-221)



















**Nr. articol: 216-222**

Ferrule; Sleeve for 0.75 mm<sup>2</sup> / 18 AWG; insulated; electro-tin plated; gray

[www.wago.com/216-222](http://www.wago.com/216-222)

Supus modificărilor.

	<b>Nr. articol:</b> 216-223 Ferrule; Sleeve for 1 mm <sup>2</sup> / AWG 18; insulated; electro-tin plated; red	<a href="http://www.wago.com/216-223">www.wago.com/216-223</a>
	<b>Nr. articol:</b> 216-224 Ferrule; Sleeve for 1.5 mm <sup>2</sup> / AWG 16; insulated; electro-tin plated; black	<a href="http://www.wago.com/216-224">www.wago.com/216-224</a>
	<b>Nr. articol:</b> 216-321 Ferrule; Sleeve for 0.25 mm <sup>2</sup> / AWG 24; insulated; electro-tin plated; yellow	<a href="http://www.wago.com/216-321">www.wago.com/216-321</a>
	<b>Nr. articol:</b> 216-322 Ferrule; Sleeve for 0.34 mm <sup>2</sup> / 22 AWG; insulated; electro-tin plated; green	<a href="http://www.wago.com/216-322">www.wago.com/216-322</a>
<b>Jumper</b>		
	<b>Nr. articol:</b> 270-409 Jumper; unplated; 9-way; Nominal current 18 A; silver-colored	<a href="http://www.wago.com/270-409">www.wago.com/270-409</a>
	<b>Nr. articol:</b> 270-417 Jumper; unplated; 17-way; Nominal current 18 A; silver-colored	<a href="http://www.wago.com/270-417">www.wago.com/270-417</a>
	<b>Nr. articol:</b> 270-480 Jumper; unplated; 80-way; Nominal current 18 A; silver-colored	<a href="http://www.wago.com/270-480">www.wago.com/270-480</a>
	<b>Nr. articol:</b> 870-402 Push-in type jumper bar; insulated; 2-way; Nominal current 18 A; light gray	<a href="http://www.wago.com/870-402">www.wago.com/870-402</a>
	<b>Nr. articol:</b> 870-403 Push-in type jumper bar; insulated; 3-way; Nominal current 18 A; light gray	<a href="http://www.wago.com/870-403">www.wago.com/870-403</a>
	<b>Nr. articol:</b> 870-404 Push-in type jumper bar; insulated; 4-way; Nominal current 18 A; light gray	<a href="http://www.wago.com/870-404">www.wago.com/870-404</a>
	<b>Nr. articol:</b> 870-405 Push-in type jumper bar; insulated; 5-way; Nominal current 18 A; light gray	<a href="http://www.wago.com/870-405">www.wago.com/870-405</a>
	<b>Nr. articol:</b> 870-405/011-000 Ready-made push-in type jumper bar; insulated; 3-way (1-3-5); Nominal current 18 A; light gray	<a href="http://www.wago.com/870-405/011-000">www.wago.com/870-405/011-000</a>
	<b>Nr. articol:</b> 870-406 Push-in type jumper bar; insulated; 6-way; Nominal current 18 A; light gray	<a href="http://www.wago.com/870-406">www.wago.com/870-406</a>
	<b>Nr. articol:</b> 870-407 Push-in type jumper bar; insulated; 7-way; Nominal current 18 A; light gray	<a href="http://www.wago.com/870-407">www.wago.com/870-407</a>
	<b>Nr. articol:</b> 870-407/011-000 Ready-made push-in type jumper bar; insulated; 1-3-5-7; Nominal current 18 A; light gray	<a href="http://www.wago.com/870-407/011-000">www.wago.com/870-407/011-000</a>
	<b>Nr. articol:</b> 870-408 Push-in type jumper bar; insulated; 8-way; Nominal current 18 A; light gray	<a href="http://www.wago.com/870-408">www.wago.com/870-408</a>
	<b>Nr. articol:</b> 870-409 Push-in type jumper bar; insulated; 9-way; Nominal current 18 A; light gray	<a href="http://www.wago.com/870-409">www.wago.com/870-409</a>

Supus modificărilor.





Nr. articol: 870-409/011-000

Ready-made push-in type jumper bar; insulated; 1-3-5-7-9; Nominal current 18 A; light gray

[www.wago.com/870-409/011-000](http://www.wago.com/870-409/011-000)

#### Insulation stop



Nr. articol: 280-470

Insulation stop; 0.08 - 0.2 mm<sup>2</sup> "s" (0.14 mm<sup>2</sup> "f-st"); 5 pieces/strip; white

[www.wago.com/280-470](http://www.wago.com/280-470)



Nr. articol: 280-471

Insulation stop; 0.25 - 0.5 mm<sup>2</sup>; 5 pieces/strip; light gray

[www.wago.com/280-471](http://www.wago.com/280-471)



Nr. articol: 280-472

Insulation stop; 0.75 - 1 mm<sup>2</sup>; 5 pieces/strip

[www.wago.com/280-472](http://www.wago.com/280-472)

#### tools



Nr. articol: 210-657

Operating tool; Blade: 3.5 x 0.5 mm; with a partially insulated shaft; short

[www.wago.com/210-657](http://www.wago.com/210-657)



Nr. articol: 210-720

Operating tool; Blade: 3.5 x 0.5 mm; with a partially insulated shaft

[www.wago.com/210-720](http://www.wago.com/210-720)

## Descărcări

### Documentation

#### Additional Information

Technical explanations

Apr 3, 2019

pdf  
2,1 MB

Descărcare

### CAD/CAE-Data

#### CAD data

2D/3D Models 270-577

URL

Descărcare

#### CAE data

EPLAN Data Portal 270-577

URL

Descărcare

WSCAD Universe 270-577

URL

Descărcare

## Installation Notes

### Commoning

Supus modificărilor.

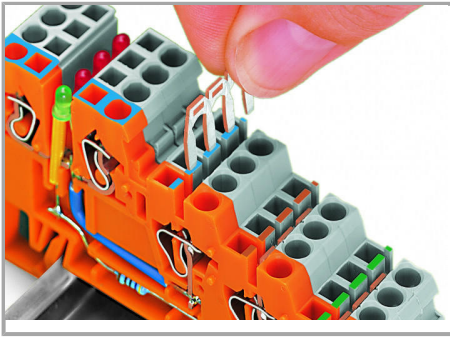

Inserting a jumper.

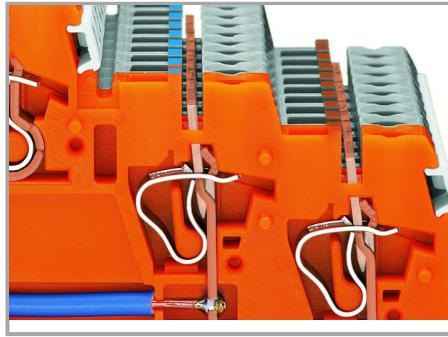

Commoning a supply voltage using uninsulated push-in type jumper bars, 2- to 9-way or 17-way (2 x 8 bits), depending on application.



Commoning signal level voltage via insulated push-in type jumper bars (870 Series) – 2- to 9-way, depending on application.

**Sensor LED terminal blocks cannot be commoned!**

#### Marking

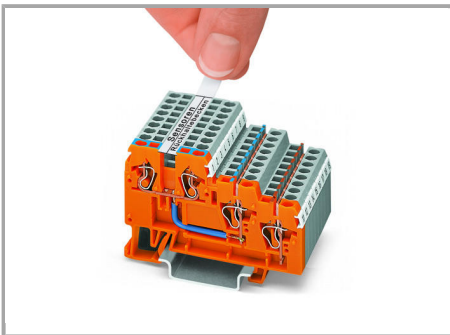

Marking strip (Item No. 709-196)

**Not suitable for LED terminal blocks!**

Supus modificărilor.