

Fișă tehnică | Număr articol: 745-604/011-000

PCB terminal block; 16 mm²; Pin spacing 15 mm; 4-pole; CAGE CLAMP®; commoning option; 16,00 mm²; gray

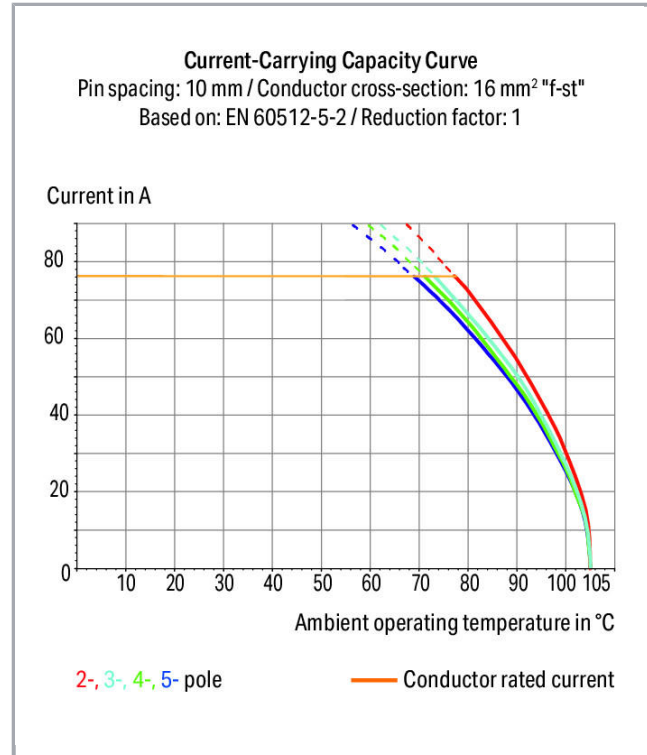

www.wago.com/745-604/011-000

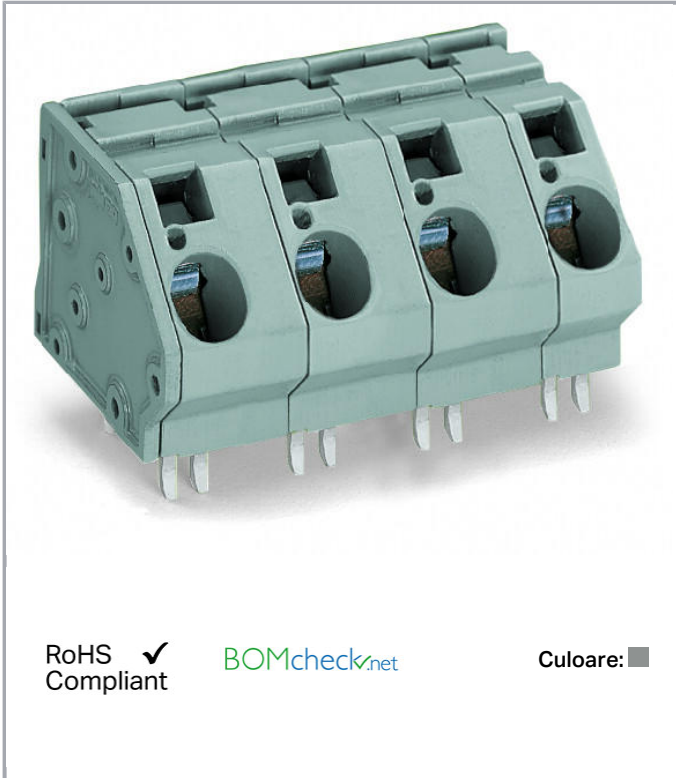

Supus modificărilor.

WAGO Kontakttechnik GmbH & Co. KG
/Representative Office Romania
Sos. Pipera-Tunari nr. 1/1
building 1, 2nd floor | 077190 Voluntari, Ilfov
Tel.: +40-(0)31 421 85 68 | Email: info-RO@wago.com

Aveți întrebări despre produsele noastre?
Vă stăm la dispoziție pentru preluarea apelului la +40 (0) 31 421 85 68.

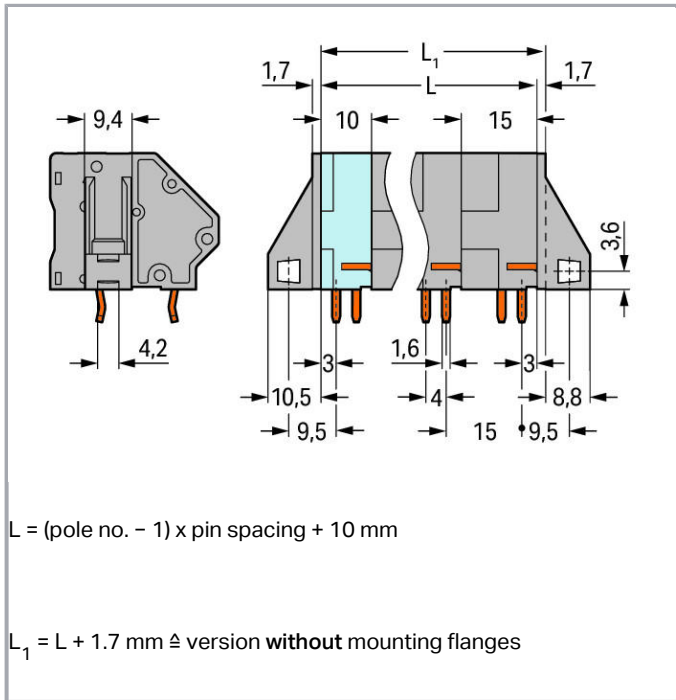

Descriere articol

- PCB terminal strips with screwdriver-actuated CAGE CLAMP® connection
- Versions with Ex approval
- Unrestricted UL approval up to 600 V with 20 mm pin spacing
- Common and distribute potentials via comb-style jumper bars
- Four solder pins for high mechanical stability
- Integrated testing tap
- Marker slot for Mini-WSB markers

Date

Electrical data

Ratings per IEC/EN 60664-1

Ratings per	IEC/EN 60664-1
Nominal voltage (III/3)	630 V
Rated surge voltage (III/3)	8 kV
Rated voltage (III/2)	630 V
Rated surge voltage (III/2)	8 kV
Nominal voltage (II/2)	1000 V

Supus modificărilor.

WAGO Kontakttechnik GmbH & Co. KG
 /Representative Office Romania
 Sos. Pipera-Tunari nr. 1/1
 building 1, 2nd floor | 077190 Voluntari, Ilfov
 Tel.: +40-(0)31 421 85 68 | Email: info-RO@wago.com

Aveți întrebări despre produsele noastre?
 Vă stăm la dispoziție pentru preluarea apelului la +40 (0) 31 421 85 68.



Rated surge voltage (II/2)	8 kV
Rated current	76 A
Legend (ratings)	(III / 2) \triangleq Overvoltage category III / Pollution degree 2

Approvals per UL 1059

Rated voltage UL (Use Group B)	300 V
Rated current UL (Use Group B)	65 A
Rated voltage UL (Use Group C)	300 V
Rated current UL (Use Group C)	65 A
Rated voltage UL (Use Group D)	600 V
Rated current UL (Use Group D)	5 A
Approvals per	UL 1059

Approvals per CSA

Rated voltage CSA (Use Group B)	300 V
Rated current CSA (Use Group B)	65 A
Rated voltage CSA (Use Group C)	300 V
Rated current CSA (Use Group C)	65 A
Rated voltage CSA (Use Group D)	600 V
Rated current CSA (Use Group D)	5 A

Connection data

Connection technology	CAGE CLAMP [®]
Actuation type	Operating tool
Solid conductor	0,2 ... 16 mm ² / 24 ... 6 AWG
Fine-stranded conductor	0,2 ... 16 mm ² / 24 ... 6 AWG
Fine-stranded conductor; with insulated ferrule	0,25 ... 10 mm ²
Fine-stranded conductor; with uninsulated ferrule	0,25 ... 10 mm ²
Strip length	12 ... 13 mm / 0.47 ... 0.51 inch
Conductor connection direction to PCB	45°
Pole No.	4
Total number of connection points	4
Total number of potentials	4
Number of connection types	1
Number of levels	1
Number of jumper slots	1

Supus modificărilor.

WAGO Kontakttechnik GmbH & Co. KG
 /Representative Office Romania
 Sos. Pipera-Tunari nr. 1/1
 building 1, 2nd floor | 077190 Voluntari, Ilfov
 Tel.: +40-(0)31 421 85 68 | Email: info-RO@wago.com

Aveți întrebări despre produsele noastre?
 Vă stăm la dispoziție pentru preluarea apelului la +40 (0) 31 421 85 68.



Geometrical Data

Pin spacing	15 mm / 0.591 inch
Width	76 mm / 2.992 inch
Height	33,5 mm / 1.319 inch
Height from the surface	27 mm / 1.063 inch
Depth	33,4 mm / 1.315 inch
Solder pin length	6,5 mm
Solder pin dimensions	1,2 x 1,6 mm
Drilled hole diameter with tolerance	2,2 ^(+0,1) mm

Mechanical data

Mounting type	Mounting flange
Mounting type	Panel mounting

PCB contact

PCB contact	THT
Solder pin arrangement	over the entire terminal strip (in-line)
Number of solder pins per potential	4

Material Data

Color	gray
Material group	I
Insulation material	Polyamide 66 (PA 66)
Flammability class per UL94	V0
Clamping spring material	Chrome nickel spring steel (CrNi)
Contact material	Electrolytic copper (E _{Cu})
Contact plating	tin-plated
Fire load	0,78 MJ
Weight	44,9 g

Environmental Requirements

Limit temperature range	-60 ... +105 °C
-------------------------	-----------------

Commercial data

Product Group	4 (Printed Circuit)
---------------	---------------------

Supus modificărilor.

WAGO Kontakttechnik GmbH & Co. KG
 /Representative Office Romania
 Sos. Pipera-Tunari nr. 1/1
 building 1, 2nd floor | 077190 Voluntari, Ilfov
 Tel.: +40-(0)31 421 85 68 | Email: info-RO@wago.com

Aveți întrebări despre produsele noastre?
 Vă stăm la dispoziție pentru preluarea apelului la +40 (0) 31 421 85 68.

Packaging type	BOX
Country of origin	PL
GTIN	4044918302982
Customs tariff number	85369010000

Aprobări / certificate

Country specific Approvals

Emblemă	Aprobare	Text de aprobare suplimentar	Nume certificat
	CSA DEKRA Certification B.V.	C22.2 No. 158	1604421





UL-Approvals

Emblemă	Aprobare	Text de aprobare suplimentar	Nume certificat
	UR Underwriters Laboratories Inc.	UL 1059	E45172 sec6

Counterpart

Produse compatibile

















Marking accessories

	Nr. articol: 2009-145 Mini-WSB Inline; for Smart Printer; 1700 pieces on roll; stretchable 5 - 5.2 mm; plain; snap-on type; white	www.wago.com/2009-145
	Nr. articol: 2009-145/000-002 Mini-WSB Inline; for Smart Printer; 1700 pieces on roll; stretchable 5 - 5.2 mm; plain; snap-on type; yellow	www.wago.com/2009-145/000-002
	Nr. articol: 2009-145/000-005 Mini-WSB Inline; for Smart Printer; 1700 pieces on roll; stretchable 5 - 5.2 mm; plain; snap-on type; red	www.wago.com/2009-145/000-005
	Nr. articol: 2009-145/000-006 Mini-WSB Inline; for Smart Printer; 1700 pieces on roll; stretchable 5 - 5.2 mm; plain; snap-on type; blue	www.wago.com/2009-145/000-006

















Supus modificărilor.

WAGO Kontakttechnik GmbH & Co. KG
/Representative Office Romania
Sos. Pipera-Tunari nr. 1/1
building 1, 2nd floor | 077190 Voluntari, Ilfov
Tel.: +40-(0)31 421 85 68 | Email: info-RO@wago.com

















Aveți întrebări despre produsele noastre?
Vă stăm la dispoziție pentru preluarea apelului la +40 (0) 31 421 85 68.

	Nr. articol: 2009-145/000-007 Mini-WSB Inline; for Smart Printer; 1700 pieces on roll; stretchable 5 - 5.2 mm; plain; snap-on type; gray	www.wago.com/2009-145/000-007
	Nr. articol: 2009-145/000-012 Mini-WSB Inline; for Smart Printer; 1700 pieces on roll; stretchable 5 - 5.2 mm; plain; snap-on type; orange	www.wago.com/2009-145/000-012
	Nr. articol: 2009-145/000-023 Mini-WSB Inline; for Smart Printer; 1700 pieces on roll; stretchable 5 - 5.2 mm; plain; snap-on type; green	www.wago.com/2009-145/000-023
	Nr. articol: 2009-145/000-024 Mini-WSB Inline; for Smart Printer; 1700 pieces on roll; stretchable 5 - 5.2 mm; plain; snap-on type; violet	www.wago.com/2009-145/000-024
	Nr. articol: 248-501 Miniature WSB Quick marking system; plain; Marker width 5 mm; 10 strips with 10 markers per card	www.wago.com/248-501
Jumper		
	Nr. articol: 745-631 Comb-style jumper bar; 2-way (1-3)	www.wago.com/745-631
	Nr. articol: 745-632 Comb-style jumper bar; 2-way	www.wago.com/745-632
	Nr. articol: 745-633 Comb-style jumper bar; 3-way	www.wago.com/745-633
	Nr. articol: 745-634 Comb-style jumper bar; 4-way	www.wago.com/745-634
ferrule		
	Nr. articol: 216-101 Ferrule; Sleeve for 0.5 mm ² / AWG 22; uninsulated; electro-tin plated	www.wago.com/216-101
	Nr. articol: 216-102 Ferrule; Sleeve for 0.75 mm ² / AWG 20; uninsulated; electro-tin plated	www.wago.com/216-102
	Nr. articol: 216-103 Ferrule; Sleeve for 1 mm ² / AWG 18; uninsulated; electro-tin plated	www.wago.com/216-103
	Nr. articol: 216-104 Ferrule; Sleeve for 1.5 mm ² / AWG 16; uninsulated; electro-tin plated	www.wago.com/216-104
	Nr. articol: 216-106 Ferrule; Sleeve for 2.5 mm ² / AWG 14; uninsulated; electro-tin plated	www.wago.com/216-106
	Nr. articol: 216-107 Ferrule; Sleeve for 4 mm ² / AWG 12; uninsulated; electro-tin plated	www.wago.com/216-107
	Nr. articol: 216-108 Ferrule; Sleeve for 6 mm ² / AWG 10; uninsulated; electro-tin plated	www.wago.com/216-108

Supus modificărilor.

	Nr. articol: 216-109 Ferrule; Sleeve for 10 mm ² / AWG 8; uninsulated; electro-tin plated	www.wago.com/216-109
	Nr. articol: 216-110 Ferrule; Sleeve for 16 mm ² / AWG 6; uninsulated; electro-tin plated	www.wago.com/216-110
	Nr. articol: 216-121 Ferrule; Sleeve for 0.5 mm ² / AWG 22; uninsulated; electro-tin plated	www.wago.com/216-121
	Nr. articol: 216-122 Ferrule; Sleeve for 0.75 mm ² / AWG 20; uninsulated; electro-tin plated	www.wago.com/216-122
	Nr. articol: 216-123 Ferrule; Sleeve for 1 mm ² / AWG 18; uninsulated; electro-tin plated	www.wago.com/216-123
	Nr. articol: 216-124 Ferrule; Sleeve for 1.5 mm ² / AWG 16; uninsulated; electro-tin plated	www.wago.com/216-124
	Nr. articol: 216-131 Ferrule; Sleeve for 0.25 mm ² / AWG 24; uninsulated; electro-tin plated	www.wago.com/216-131
	Nr. articol: 216-132 Ferrule; Sleeve for 0.34 mm ² / AWG 24; uninsulated; electro-tin plated	www.wago.com/216-132
	Nr. articol: 216-141 Ferrule; Sleeve for 0.5 mm ² / 20 AWG; uninsulated; electro-tin plated; electrolytic copper; gastight crimped; acc. to DIN 46228, Part 1/08.92	www.wago.com/216-141
	Nr. articol: 216-142 Ferrule; Sleeve for 0.75 mm ² / 18 AWG; uninsulated; electro-tin plated; electrolytic copper; gastight crimped; acc. to DIN 46228, Part 1/08.92	www.wago.com/216-142
	Nr. articol: 216-143 Ferrule; Sleeve for 1 mm ² / AWG 18; uninsulated; electro-tin plated; electrolytic copper; gastight crimped; acc. to DIN 46228, Part 1/08.92	www.wago.com/216-143
	Nr. articol: 216-144 Ferrule; Sleeve for 1.5 mm ² / AWG 16; uninsulated; electro-tin plated; electrolytic copper; gastight crimped; acc. to DIN 46228, Part 1/08.92	www.wago.com/216-144
	Nr. articol: 216-151 Ferrule; Sleeve for 0.25 mm ² / AWG 24; uninsulated; electro-tin plated	www.wago.com/216-151
	Nr. articol: 216-152 Ferrule; Sleeve for 0.34 mm ² / AWG 24; uninsulated; electro-tin plated	www.wago.com/216-152
	Nr. articol: 216-201 Ferrule; Sleeve for 0.5 mm ² / 20 AWG; insulated; electro-tin plated; white	www.wago.com/216-201
	Nr. articol: 216-202 Ferrule; Sleeve for 0.75 mm ² / 18 AWG; insulated; electro-tin plated; gray	www.wago.com/216-202
	Nr. articol: 216-203 Ferrule; Sleeve for 1 mm ² / AWG 18; insulated; electro-tin plated; red	www.wago.com/216-203











Supus modificărilor.

	Nr. articol: 216-204 Ferrule; Sleeve for 1.5 mm ² / AWG 16; insulated; electro-tin plated; black	www.wago.com/216-204
	Nr. articol: 216-205 Ferrule; Sleeve for 2.08 mm ² / AWG 14; insulated; electro-tin plated; yellow	www.wago.com/216-205
	Nr. articol: 216-206 Ferrule; Sleeve for 2.5 mm ² / AWG 14; insulated; electro-tin plated; blue	www.wago.com/216-206
	Nr. articol: 216-207 Ferrule; Sleeve for 4 mm ² / AWG 12; insulated; electro-tin plated; gray	www.wago.com/216-207
	Nr. articol: 216-208 Ferrule; Sleeve for 6 mm ² / AWG 10; insulated; electro-tin plated; electrolytic copper; gastight crimped; acc. to DIN 46228, Part 4/09.90; yellow	www.wago.com/216-208
	Nr. articol: 216-209 Ferrule; Sleeve for 10 mm ² / AWG 8; insulated; electro-tin plated; red	www.wago.com/216-209
	Nr. articol: 216-210 Ferrule; Sleeve for 16 mm ² / AWG 6; insulated; electro-tin plated; electrolytic copper; gastight crimped; acc. to DIN 46228, Part 4/09.90; blue	www.wago.com/216-210
	Nr. articol: 216-221 Ferrule; Sleeve for 0.5 mm ² / 20 AWG; insulated; electro-tin plated; white	www.wago.com/216-221
	Nr. articol: 216-222 Ferrule; Sleeve for 0.75 mm ² / 18 AWG; insulated; electro-tin plated; gray	www.wago.com/216-222
	Nr. articol: 216-223 Ferrule; Sleeve for 1 mm ² / AWG 18; insulated; electro-tin plated; red	www.wago.com/216-223
	Nr. articol: 216-224 Ferrule; Sleeve for 1.5 mm ² / AWG 16; insulated; electro-tin plated; black	www.wago.com/216-224
	Nr. articol: 216-241 Ferrule; Sleeve for 0.5 mm ² / 20 AWG; insulated; electro-tin plated; electrolytic copper; gastight crimped; acc. to DIN 46228, Part 4/09.90; white	www.wago.com/216-241
	Nr. articol: 216-242 Ferrule; Sleeve for 0.75 mm ² / 18 AWG; insulated; electro-tin plated; electrolytic copper; gastight crimped; acc. to DIN 46228, Part 4/09.90; gray	www.wago.com/216-242
	Nr. articol: 216-243 Ferrule; Sleeve for 1 mm ² / AWG 18; insulated; electro-tin plated; electrolytic copper; gastight crimped; acc. to DIN 46228, Part 4/09.90; red	www.wago.com/216-243
	Nr. articol: 216-244 Ferrule; Sleeve for 1.5 mm ² / AWG 16; insulated; electro-tin plated; electrolytic copper; gastight crimped; acc. to DIN 46228, Part 4/09.90; black	www.wago.com/216-244
	Nr. articol: 216-246 Ferrule; Sleeve for 2.5 mm ² / AWG 14; insulated; electro-tin plated; electrolytic copper; gastight crimped; acc. to DIN 46228, Part 4/09.90; blue	www.wago.com/216-246
	Nr. articol: 216-262 Ferrule; Sleeve for 0.75 mm ² / 18 AWG; insulated; electro-tin plated; electrolytic copper; gastight crimped; acc. to DIN 46228, Part 4/09.90; gray	www.wago.com/216-262

Supus modificărilor.

WAGO Kontakttechnik GmbH & Co. KG
/Representative Office Romania
Sos. Pipera-Tunari nr. 1/1
building 1, 2nd floor | 077190 Voluntari, Ilfov
Tel.: +40-(0)31 421 85 68 | Email: info-RO@wago.com

Aveți întrebări despre produsele noastre?
Vă stăm la dispoziție pentru preluarea apelului la +40 (0) 31 421 85 68.

	Nr. articol: 216-263 Ferrule; Sleeve for 1 mm ² / AWG 18; insulated; electro-tin plated; electrolytic copper; gastight crimped; acc. to DIN 46228, Part 4/09.90; red	www.wago.com/216-263
	Nr. articol: 216-264 Ferrule; Sleeve for 1.5 mm ² / AWG 16; insulated; electro-tin plated; electrolytic copper; gastight crimped; acc. to DIN 46228, Part 4/09.90; black	www.wago.com/216-264
	Nr. articol: 216-266 Ferrule; Sleeve for 2.5 mm ² / AWG 14; insulated; electro-tin plated; electrolytic copper; gastight crimped; acc. to DIN 46228, Part 4/09.90; blue	www.wago.com/216-266
	Nr. articol: 216-267 Ferrule; Sleeve for 4 mm ² / AWG 12; insulated; electro-tin plated; electrolytic copper; gastight crimped; acc. to DIN 46228, Part 4/09.90; gray	www.wago.com/216-267
	Nr. articol: 216-284 Ferrule; Sleeve for 1.5 mm ² / AWG 16; insulated; electro-tin plated; electrolytic copper; gastight crimped; acc. to DIN 46228, Part 4/09.90; black	www.wago.com/216-284
	Nr. articol: 216-286 Ferrule; Sleeve for 2.5 mm ² / AWG 14; insulated; electro-tin plated; electrolytic copper; gastight crimped; acc. to DIN 46228, Part 4/09.90; blue	www.wago.com/216-286
	Nr. articol: 216-287 Ferrule; Sleeve for 4 mm ² / AWG 12; insulated; electro-tin plated; electrolytic copper; gastight crimped; acc. to DIN 46228, Part 4/09.90; gray	www.wago.com/216-287
	Nr. articol: 216-288 Ferrule; Sleeve for 6 mm ² / AWG 10; insulated; electro-tin plated; electrolytic copper; gastight crimped; acc. to DIN 46228, Part 4/09.90; yellow	www.wago.com/216-288
	Nr. articol: 216-289 Ferrule; Sleeve for 10 mm ² / AWG 8; insulated; electro-tin plated; electrolytic copper; gastight crimped; acc. to DIN 46228, Part 4/09.90; red	www.wago.com/216-289
	Nr. articol: 216-301 Ferrule; Sleeve for 0.25 mm ² / AWG 24; insulated; electro-tin plated; yellow	www.wago.com/216-301
	Nr. articol: 216-302 Ferrule; Sleeve for 0.34 mm ² / 22 AWG; insulated; electro-tin plated; green	www.wago.com/216-302
	Nr. articol: 216-321 Ferrule; Sleeve for 0.25 mm ² / AWG 24; insulated; electro-tin plated; yellow	www.wago.com/216-321
	Nr. articol: 216-322 Ferrule; Sleeve for 0.34 mm ² / 22 AWG; insulated; electro-tin plated; green	www.wago.com/216-322

Descărcări

Documentation

Additional Information

Technical explanations	Apr 3, 2019	pdf 3,6 MB	Descărcare
------------------------	-------------	---------------	------------

Supus modificărilor.

WAGO Kontakttechnik GmbH & Co. KG
/Representative Office Romania
Sos. Pipera-Tunari nr. 1/1
building 1, 2nd floor | 077190 Voluntari, Ilfov
Tel.: +40-(0)31 421 85 68 | Email: info-RO@wago.com

Aveți întrebări despre produsele noastre?
Vă stăm la dispoziție pentru preluarea apelului la +40 (0) 31 421 85 68.



CAD/CAE-Data

CAD data

2D/3D Models 745-604/011-000	URL	Descărcare
------------------------------	-----	------------

CAE data

EPLAN Data Portal 745-604/011-000	URL	Descărcare
-----------------------------------	-----	------------

PCB Design

Symbol and Footprint 745-604/011-000	URL	Descărcare
--------------------------------------	-----	------------

CAX data for your PCB design, consisting of "schematic symbols and PCB footprints", allow easy integration of the WAGO component into your development environment.

Supported formats:

- Accel EDA 14 & 15
- Altium 6 to current version
- Cadence Allegro
- DesignSpark
- Eagle Libraries
- KiCad
- Mentor Graphics BoardStation
- Mentor Graphics Design Architect
- Mentor Graphics Design Expedition 99 and 2000
- OrCAD 9.X PCB and Capture
- PADS PowerPCB 3, 3.5, 4.X, and 5.X
- PADS PowerPCB and PowerLogic 3.0
- PCAD 2000, 2001, 2002, 2004, and 2006
- Pulsonix 8.5 or newer
- STL
- 3D STEP
- TARGET 3001!
- View Logic ViewDraw
- Quadcept
- Zuken CadStar 3 and 4
- Zuken CR-5000 and CR-8000

PCB Component Libraries (EDA), PCB CAD Library Ultra Librarian

Supus modificărilor.

WAGO Kontakttechnik GmbH & Co. KG
 /Representative Office Romania
 Sos. Pipera-Tunari nr. 1/1
 building 1, 2nd floor | 077190 Voluntari, Ilfov
 Tel.: +40-(0)31 421 85 68 | Email: info-RO@wago.com

Aveți întrebări despre produsele noastre?
 Vă stăm la dispoziție pentru preluarea apelului la +40 (0) 31 421 85 68.

Installation Notes

Conductor termination

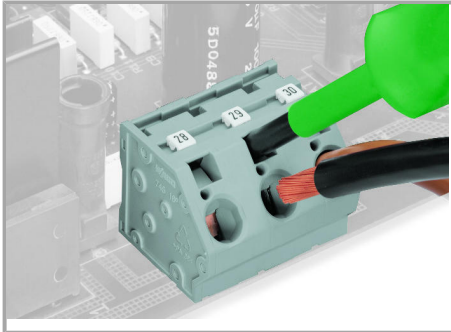

Inserting/removing a conductor via 5.5 mm screwdriver – 745 Series, 16 mm².

Marking

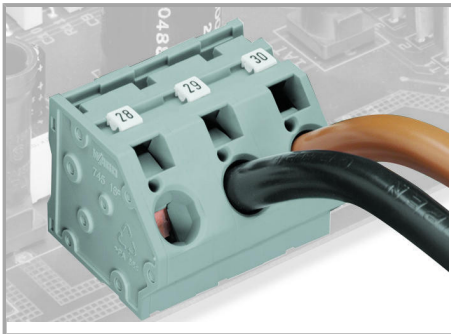

Marking via miniature WSB and WMB markers or factory direct marking – 745 Series.

Testing

Supus modificărilor.

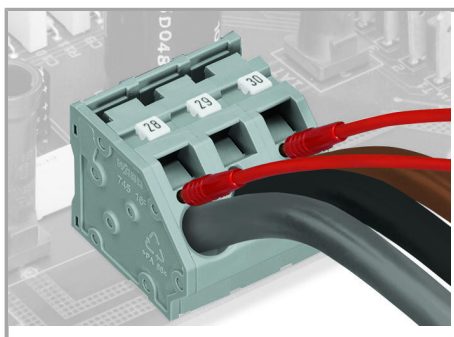

Testing with test plug – 745 Series.

Commoning

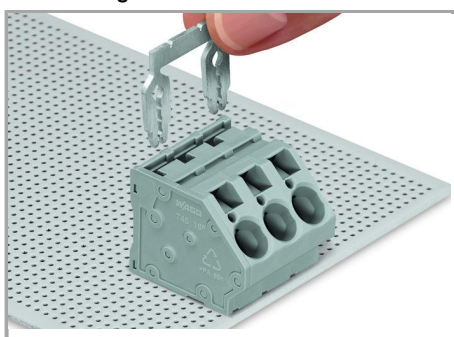

Inserting a comb-style jumper bar.

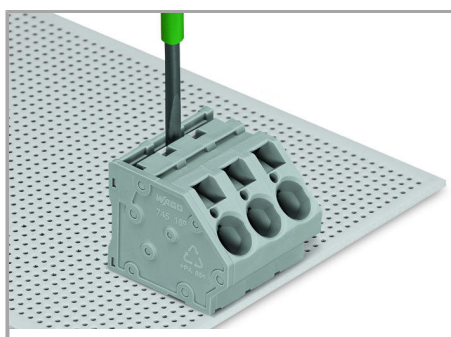

To insert a comb-style jumper bar, push it down using a screwdriver until it hits the backstop – 745 Series.

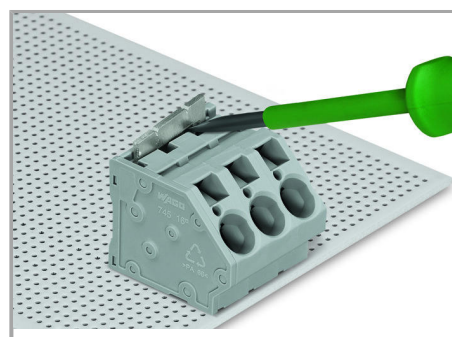

To remove the comb-style jumper bar, lift it up using a screwdriver – 745 Series.

Supus modificărilor.