

Fișă tehnică | Număr articol: 280-875

4-conductor disconnect/test terminal block; with shield contact; with test port; for DIN-rail 35 x 15 and 35 x 7.5; 2.5 mm²; CAGE CLAMP®; 2,50 mm²; gray

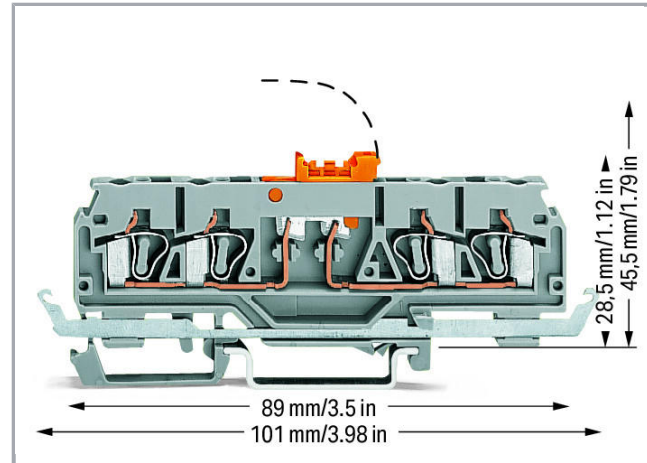

www.wago.com/280-875

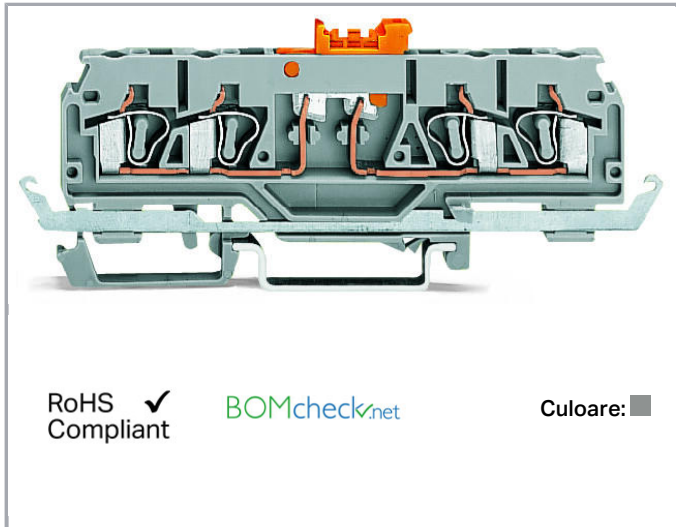

Descriere articol

Note:

Terminating Aluminum Conductors

WAGO spring clamp terminal blocks are suitable for solid aluminum conductors up to 4 mm²/12 AWG if WAGO "Alu-Plus" Contact Paste is used for termination.

"Alu-Plus" Contact Paste Advantages:

- Automatically destroys the oxide film during clamping.
- Prevents fresh oxidation at the clamping point.
- Prevents electrolytic corrosion between aluminum and copper conductors (in the same terminal block).
- Provides long-term protection against corrosion.

Using terminal blocks with CAGE CLAMP® Spring Pressure Connection Technology, **aluminum conductors must first be cleaned with a blade** and then immediately be inserted into the clamping units filled with "Alu-Plus" Contact Paste.

It is also possible to apply WAGO "Alu-Plus" **additionally** on the whole surface of the aluminum conductor before termination.

Please note that the nominal currents must be adapted to the reduced conductivity of the aluminum conductors::

2.5 mm² = 16 A

4 mm² = 22 A

Supus modificărilor.

WAGO Kontakttechnik GmbH & Co. KG
/Representative Office Romania
Sos. Pipera-Tunari nr. 1/1
building 1, 2nd floor | 077190 Voluntari, Ilfov
Tel.: +40-(0)31 421 85 68 | Email: info-RO@wago.com

Aveți întrebări despre produsele noastre?
Vă stăm la dispoziție pentru preluarea apelului la +40 (0) 31 421 85 68.

**Date****Electrical data****Ratings per IEC/EN 60664-1**

Nominal voltage (III/3)	250 V
Rated surge voltage (III/3)	4 kV
Rated current	16 A
Legend (ratings)	(III / 3) \triangleq Overvoltage category III / Pollution degree 3

Connection data

Connection technology	CAGE CLAMP [®]
Actuation type	Operating tool
Connectable conductor materials	Copper Aluminum
Solid conductor	0,08 ... 2,5 mm ² / 28 ... 12 AWG
Fine-stranded conductor	0,08 ... 2,5 mm ² / 28 ... 12 AWG
Strip length	8 ... 9 mm / 0.31 ... 0.35 inch
Total number of connection points	4
Total number of potentials	2
Number of levels	1
Wiring type	Front-entry wiring
Note (conductor cross-section)	12 AWG: THHN, THWN

Geometrical Data

Width	5 mm / 0.197 inch
Height from upper-edge of DIN-rail	28,5 mm / 1.122 inch
Depth	101 mm / 3.976 inch

Mechanical data

Design	horizontal type
Mounting type	DIN-35 rail
Marking level	Center/side marking

Material Data

Color	gray
Insulation material	Polyamide 66 (PA 66)

Supus modificărilor.

WAGO Kontakttechnik GmbH & Co. KG
 /Representative Office Romania
 Sos. Pipera-Tunari nr. 1/1
 building 1, 2nd floor | 077190 Voluntari, Ilfov
 Tel.: +40-(0)31 421 85 68 | Email: info-RO@wago.com

Aveți întrebări despre produsele noastre?
 Vă stăm la dispoziție pentru preluarea apelului la +40 (0) 31 421 85 68.



Fire load	0,191 MJ
Weight	14,2g

Commercial data





Product Group	1 (Rail Mounted Terminal Blocks)
Packaging type	BOX
Country of origin	CN
GTIN	4050821014676
Customs tariff number	85365080900

Aprobări / certificate

Country specific Approvals

Emblemă	Aprobare	Text de aprobare suplimentar	Nume certificat
	CCA DEKRA Certification B.V.	EN 60947	2157201.01
	CSA DEKRA Certification B.V.	C22.2	1536071

Ship Approvals

Emblemă	Aprobare	Text de aprobare suplimentar	Nume certificat
	ABS American Bureau of Shipping	EN 60947	20-HG1941090-PDA
	BV Bureau Veritas S.A.	EN 60947	07436/E0 BV
	DNV GL Det Norske Veritas, Germanischer Lloyd	-	TAE00001V2
	LR Lloyds Register	EN 60947	91/20112 (E9)

Supus modificărilor.

WAGO Kontakttechnik GmbH & Co. KG
/Representative Office Romania
Sos. Pipera-Tunari nr. 1/1
building 1, 2nd floor | 077190 Voluntari, Ilfov
Tel.: +40-(0)31 421 85 68 | Email: info-RO@wago.com

Aveți întrebări despre produsele noastre?
Vă stăm la dispoziție pentru preluarea apelului la +40 (0) 31 421 85 68.

UL-Approvals

Emblemă	Aprobare	Text de aprobare suplimentar	Nume certificat
	UL Underwriters Laboratories Inc.	UL 1059	20170731- E45172





Counterpart

Produse compatibile

Protective Warning Marker

	Nr. articol: 280-415 Protective warning marker; with high-voltage symbol, black; for 5 terminal blocks; yellow	www.wago.com/280-415
------------------------------------------------------------------------------------	--------------------------------------------------------------------------------------------------------------------------	----------------------------------------------------------------

















Carrier rail

	Nr. articol: 210-112 Steel carrier rail; 35 x 7.5 mm; 1 mm thick; 2 m long; slotted; according to EN 60715; "Hole width 25 mm	www.wago.com/210-112
	Nr. articol: 210-113 Steel carrier rail; 35 x 7.5 mm; 1 mm thick; 2 m long; unslotted; according to EN 60715	www.wago.com/210-113
	Nr. articol: 210-114 Steel carrier rail; 35 x 15 mm; 1.5 mm thick; 2 m long; unslotted; similar to EN 60715	www.wago.com/210-114
	Nr. articol: 210-115 Steel carrier rail; 35 x 7.5 mm; 1 mm thick; 2 m long; slotted; according to EN 60715; "Hole width 18 mm	www.wago.com/210-115
	Nr. articol: 210-118 Steel carrier rail; 35 x 15 mm; 2.3 mm thick; 2 m long; unslotted; according to EN 60715	www.wago.com/210-118
	Nr. articol: 210-196	













Supus modificărilor.

WAGO Kontakttechnik GmbH & Co. KG
/Representative Office Romania
Sos. Pipera-Tunari nr. 1/1
building 1, 2nd floor | 077190 Voluntari, Ilfov
Tel.: +40-(0)31 421 85 68 | Email: info-RO@wago.com













Aveți întrebări despre produsele noastre?
Vă stăm la dispoziție pentru preluarea apelului la +40 (0) 31 421 85 68.

	Aluminum carrier rail; 35 x 8.2 mm; 1.6 mm thick; 2 m long; unslotted; similar to EN 60715; silver-colored	www.wago.com/210-196
	Nr. articol: 210-197 Steel carrier rail; 35 x 15 mm; 1.5 mm thick; 2 m long; slotted; similar to EN 60715	www.wago.com/210-197
	Nr. articol: 210-198 Copper carrier rail; 35 x 15 mm; 2.3 mm thick; 2 m long; unslotted; according to EN 60715; copper-colored	www.wago.com/210-198
	Nr. articol: 210-504 Steel carrier rail; 35 x 7.5 mm; 1 mm thick; 2 m long; slotted; galvanized; according to EN 60715	www.wago.com/210-504
	Nr. articol: 210-505 Steel carrier rail; 35 x 7.5 mm; 1 mm thick; 2 m long; unslotted; galvanized; according to EN 60715	www.wago.com/210-505
	Nr. articol: 210-506 Steel carrier rail; 35 x 15 mm; 1.5 mm thick; 2 m long; unslotted; galvanized; similar to EN 60715	www.wago.com/210-506
	Nr. articol: 210-508 Steel carrier rail; 35 x 15 mm; 1.5 mm thick; 2 m long; slotted; galvanized; similar to EN 60715	www.wago.com/210-508
check		
	Nr. articol: 210-136 Test plug; 2 mm Ø; with 500 mm cable; red	www.wago.com/210-136
	Nr. articol: 210-137 Test plug; 2.3 mm Ø; with 500 mm cable; yellow	www.wago.com/210-137
	Nr. articol: 249-141 L-type test plug module; modular; with spring-loaded contact pin; Center module; 1,50 mm ² ; gray	www.wago.com/249-141
ferrule		
	Nr. articol: 216-101 Ferrule; Sleeve for 0.5 mm ² / AWG 22; uninsulated; electro-tin plated	www.wago.com/216-101
	Nr. articol: 216-102 Ferrule; Sleeve for 0.75 mm ² / AWG 20; uninsulated; electro-tin plated	www.wago.com/216-102
	Nr. articol: 216-103 Ferrule; Sleeve for 1 mm ² / AWG 18; uninsulated; electro-tin plated	www.wago.com/216-103
	Nr. articol: 216-104 Ferrule; Sleeve for 1.5 mm ² / AWG 16; uninsulated; electro-tin plated	www.wago.com/216-104
	Nr. articol: 216-201 Ferrule; Sleeve for 0.5 mm ² / 20 AWG; insulated; electro-tin plated; white	www.wago.com/216-201
	Nr. articol: 216-202 Ferrule; Sleeve for 0.75 mm ² / 18 AWG; insulated; electro-tin plated; gray	www.wago.com/216-202
	Nr. articol: 216-203 Ferrule; Sleeve for 1 mm ² / AWG 18; insulated; electro-tin plated; red	www.wago.com/216-203













Supus modificărilor.

	Nr. articol: 216-204 Ferrule; Sleeve for 1.5 mm ² / AWG 16; insulated; electro-tin plated; black	www.wago.com/216-204
	Nr. articol: 216-301 Ferrule; Sleeve for 0.25 mm ² / AWG 24; insulated; electro-tin plated; yellow	www.wago.com/216-301
	Nr. articol: 216-302 Ferrule; Sleeve for 0.34 mm ² / 22 AWG; insulated; electro-tin plated; green	www.wago.com/216-302
Insulation stop		
	Nr. articol: 280-470 Insulation stop; 0.08 - 0.2 mm ² "s" (0.14 mm ² "f-st"); 5 pieces/strip; white	www.wago.com/280-470
	Nr. articol: 280-471 Insulation stop; 0.25 - 0.5 mm ² ; 5 pieces/strip; light gray	www.wago.com/280-471
	Nr. articol: 280-472 Insulation stop; 0.75 - 1 mm ² ; 5 pieces/strip	www.wago.com/280-472
assembling		
	Nr. articol: 209-106 Mounting carrier; for isolated mounting on DIN 35 rails; gray	www.wago.com/209-106
	Nr. articol: 709-153 Cover; Type 1; suitable for cover carrier, type 1; 1 m long; transparent	www.wago.com/709-153
Female plug		
	Nr. articol: 232-132/005-000 Female connector for rail-mount terminal blocks; 0.6 x 1 mm pins; straight; Pin spacing 5 mm; 2-pole; gray	www.wago.com/232-132/005-000
	Nr. articol: 232-132/005-000/039-000 Female connector for rail-mount terminal blocks; 0.6 x 1 mm pins; straight; Locking lever; Pin spacing 5 mm; 2-pole; gray	www.wago.com/232-132/005-000/039-000
	Nr. articol: 232-133/005-000 Female connector for rail-mount terminal blocks; 0.6 x 1 mm pins; straight; Pin spacing 5 mm; 3-pole; gray	www.wago.com/232-133/005-000
	Nr. articol: 232-133/005-000/039-000 Female connector for rail-mount terminal blocks; 0.6 x 1 mm pins; straight; Locking lever; Pin spacing 5 mm; 3-pole; gray	www.wago.com/232-133/005-000/039-000
	Nr. articol: 232-134/005-000 Female connector for rail-mount terminal blocks; 0.6 x 1 mm pins; straight; Pin spacing 5 mm; 4-pole; gray	www.wago.com/232-134/005-000
	Nr. articol: 232-134/005-000/039-000 Female connector for rail-mount terminal blocks; 0.6 x 1 mm pins; straight; Locking lever; Pin spacing 5 mm; 4-pole; gray	www.wago.com/232-134/005-000/039-000
	Nr. articol: 232-135/005-000	

Supus modificărilor.













	Female connector for rail-mount terminal blocks; 0.6 x 1 mm pins; straight; Pin spacing 5 mm; 5-pole; gray	www.wago.com/232-135/005-000
	Nr. articol: 232-135/005-000/039-000 Female connector for rail-mount terminal blocks; 0.6 x 1 mm pins; straight; Locking lever; Pin spacing 5 mm; 5-pole; gray	www.wago.com/232-135/005-000/039-000
	Nr. articol: 232-136/005-000 Female connector for rail-mount terminal blocks; 0.6 x 1 mm pins; straight; Pin spacing 5 mm; 6-pole; gray	www.wago.com/232-136/005-000
	Nr. articol: 232-136/005-000/039-000 Female connector for rail-mount terminal blocks; 0.6 x 1 mm pins; straight; Locking lever; Pin spacing 5 mm; 6-pole; gray	www.wago.com/232-136/005-000/039-000
	Nr. articol: 232-137/005-000 Female connector for rail-mount terminal blocks; 0.6 x 1 mm pins; straight; Pin spacing 5 mm; 7-pole; gray	www.wago.com/232-137/005-000
	Nr. articol: 232-137/005-000/039-000 Female connector for rail-mount terminal blocks; 0.6 x 1 mm pins; straight; Locking lever; Pin spacing 5 mm; 7-pole; gray	www.wago.com/232-137/005-000/039-000
	Nr. articol: 232-138/005-000 Female connector for rail-mount terminal blocks; 0.6 x 1 mm pins; straight; Pin spacing 5 mm; 8-pole; gray	www.wago.com/232-138/005-000
	Nr. articol: 232-138/005-000/039-000 Female connector for rail-mount terminal blocks; 0.6 x 1 mm pins; straight; Locking lever; Pin spacing 5 mm; 8-pole; gray	www.wago.com/232-138/005-000/039-000
	Nr. articol: 232-139/005-000 Female connector for rail-mount terminal blocks; 0.6 x 1 mm pins; straight; Pin spacing 5 mm; 9-pole; gray	www.wago.com/232-139/005-000
	Nr. articol: 232-139/005-000/039-000 Female connector for rail-mount terminal blocks; 0.6 x 1 mm pins; straight; Locking lever; Pin spacing 5 mm; 9-pole; gray	www.wago.com/232-139/005-000/039-000
	Nr. articol: 232-140/005-000 Female connector for rail-mount terminal blocks; 0.6 x 1 mm pins; straight; Pin spacing 5 mm; 10-pole; gray	www.wago.com/232-140/005-000
	Nr. articol: 232-140/005-000/039-000 Female connector for rail-mount terminal blocks; 0.6 x 1 mm pins; straight; Locking lever; Pin spacing 5 mm; 10-pole; gray	www.wago.com/232-140/005-000/039-000
	Nr. articol: 232-142/005-000 Female connector for rail-mount terminal blocks; 0.6 x 1 mm pins; straight; Pin spacing 5 mm; 12-pole; gray	www.wago.com/232-142/005-000
	Nr. articol: 232-142/005-000/039-000	

Supus modificărilor.













	Female connector for rail-mount terminal blocks; 0.6 x 1 mm pins; straight; Locking lever; Pin spacing 5 mm; 12-pole; gray	www.wago.com/232-142/005-000/039-000
	Nr. articol: 232-146/005-000 Female connector for rail-mount terminal blocks; 0.6 x 1 mm pins; straight; Pin spacing 5 mm; 16-pole; gray	www.wago.com/232-146/005-000
	Nr. articol: 232-146/005-000/039-000 Female connector for rail-mount terminal blocks; 0.6 x 1 mm pins; straight; Locking lever; Pin spacing 5 mm; 16-pole; gray	www.wago.com/232-146/005-000/039-000
	Nr. articol: 232-147/005-000/039-000 Female connector for rail-mount terminal blocks; 0.6 x 1 mm pins; straight; Locking lever; Pin spacing 5 mm; 17-pole; gray	www.wago.com/232-147/005-000/039-000
	Nr. articol: 232-150/005-000 Female connector for rail-mount terminal blocks; 0.6 x 1 mm pins; straight; Pin spacing 5 mm; 20-pole; gray	www.wago.com/232-150/005-000
	Nr. articol: 232-150/005-000/039-000 Female connector for rail-mount terminal blocks; 0.6 x 1 mm pins; straight; Locking lever; Pin spacing 5 mm; 20-pole; gray	www.wago.com/232-150/005-000/039-000
	Nr. articol: 232-232/005-000 Female connector for rail-mount terminal blocks; 0.6 x 1 mm pins; angled; Pin spacing 5 mm; 2-pole; gray	www.wago.com/232-232/005-000
	Nr. articol: 232-232/005-000/039-000 Female connector for rail-mount terminal blocks; 0.6 x 1 mm pins; angled; Locking lever; Pin spacing 5 mm; 2-pole; gray	www.wago.com/232-232/005-000/039-000
	Nr. articol: 232-233/005-000 Female connector for rail-mount terminal blocks; 0.6 x 1 mm pins; angled; Pin spacing 5 mm; 3-pole; gray	www.wago.com/232-233/005-000
	Nr. articol: 232-233/005-000/039-000 Female connector for rail-mount terminal blocks; 0.6 x 1 mm pins; angled; Locking lever; Pin spacing 5 mm; 3-pole; gray	www.wago.com/232-233/005-000/039-000
	Nr. articol: 232-234/005-000 Female connector for rail-mount terminal blocks; 0.6 x 1 mm pins; angled; Pin spacing 5 mm; 4-pole; gray	www.wago.com/232-234/005-000
	Nr. articol: 232-234/005-000/039-000 Female connector for rail-mount terminal blocks; 0.6 x 1 mm pins; angled; Locking lever; Pin spacing 5 mm; 4-pole; gray	www.wago.com/232-234/005-000/039-000
	Nr. articol: 232-235/005-000 Female connector for rail-mount terminal blocks; 0.6 x 1 mm pins; angled; Pin spacing 5 mm; 5-pole; gray	www.wago.com/232-235/005-000

Nr. articol: 232-235/005-000/039-000













Supus modificărilor.

	Female connector for rail-mount terminal blocks; 0.6 x 1 mm pins; angled; Locking lever; Pin spacing 5 mm; 5-pole; gray	www.wago.com/232-235/005-000/039-000
	Nr. articol: 232-236/005-000 Female connector for rail-mount terminal blocks; 0.6 x 1 mm pins; angled; Pin spacing 5 mm; 6-pole; gray	www.wago.com/232-236/005-000
	Nr. articol: 232-236/005-000/039-000 Female connector for rail-mount terminal blocks; 0.6 x 1 mm pins; angled; Locking lever; Pin spacing 5 mm; 6-pole; gray	www.wago.com/232-236/005-000/039-000
	Nr. articol: 232-237/005-000 Female connector for rail-mount terminal blocks; 0.6 x 1 mm pins; angled; Pin spacing 5 mm; 7-pole; gray	www.wago.com/232-237/005-000
	Nr. articol: 232-238/005-000 Female connector for rail-mount terminal blocks; 0.6 x 1 mm pins; angled; Pin spacing 5 mm; 8-pole; gray	www.wago.com/232-238/005-000
	Nr. articol: 232-239/005-000 Female connector for rail-mount terminal blocks; 0.6 x 1 mm pins; angled; Pin spacing 5 mm; 9-pole; gray	www.wago.com/232-239/005-000
	Nr. articol: 232-240/005-000 Female connector for rail-mount terminal blocks; 0.6 x 1 mm pins; angled; Pin spacing 5 mm; 10-pole; gray	www.wago.com/232-240/005-000
	Nr. articol: 232-240/005-000/039-000 Female connector for rail-mount terminal blocks; 0.6 x 1 mm pins; angled; Locking lever; Pin spacing 5 mm; 10-pole; gray	www.wago.com/232-240/005-000/039-000
	Nr. articol: 232-242/005-000 Female connector for rail-mount terminal blocks; 0.6 x 1 mm pins; angled; Pin spacing 5 mm; 12-pole; gray	www.wago.com/232-242/005-000
	Nr. articol: 232-242/005-000/039-000 Female connector for rail-mount terminal blocks; 0.6 x 1 mm pins; angled; Locking lever; Pin spacing 5 mm; 12-pole; gray	www.wago.com/232-242/005-000/039-000
	Nr. articol: 232-246/005-000 Female connector for rail-mount terminal blocks; 0.6 x 1 mm pins; angled; Pin spacing 5 mm; 16-pole; gray	www.wago.com/232-246/005-000
	Nr. articol: 232-246/005-000/039-000 Female connector for rail-mount terminal blocks; 0.6 x 1 mm pins; angled; Locking lever; Pin spacing 5 mm; 16-pole; gray	www.wago.com/232-246/005-000/039-000
	Nr. articol: 232-250/005-000 Female connector for rail-mount terminal blocks; 0.6 x 1 mm pins; angled; Pin spacing 5 mm; 20-pole; gray	www.wago.com/232-250/005-000
	Nr. articol: 232-250/005-000/039-000	













Supus modificărilor.

	Female connector for rail-mount terminal blocks; 0.6 x 1 mm pins; angled; Locking lever; Pin spacing 5 mm; 20-pole; gray	www.wago.com/232-250/005-000/039-000
	Nr. articol: 232-732/005-000 THT female header; 0.6 x 1.0 mm solder pin; gray	www.wago.com/232-732/005-000
	Nr. articol: 232-733/005-000 THT female header; 0.6 x 1.0 mm solder pin; gray	www.wago.com/232-733/005-000
	Nr. articol: 232-734/005-000 THT female header; 0.6 x 1.0 mm solder pin; gray	www.wago.com/232-734/005-000
	Nr. articol: 232-734/005-000/039-000 THT female header; 0.6 x 1.0 mm solder pin; gray	www.wago.com/232-734/005-000/039-000
	Nr. articol: 232-735/005-000 THT female header; 0.6 x 1.0 mm solder pin; gray	www.wago.com/232-735/005-000
	Nr. articol: 232-735/005-000/039-000 THT female header; 0.6 x 1.0 mm solder pin; gray	www.wago.com/232-735/005-000/039-000
	Nr. articol: 232-736/005-000 THT female header; 0.6 x 1.0 mm solder pin; gray	www.wago.com/232-736/005-000
	Nr. articol: 232-736/005-000/039-000 THT female header; 0.6 x 1.0 mm solder pin; gray	www.wago.com/232-736/005-000/039-000
	Nr. articol: 232-738/005-000 THT female header; 0.6 x 1.0 mm solder pin; gray	www.wago.com/232-738/005-000
	Nr. articol: 232-740/005-000 THT female header; 0.6 x 1.0 mm solder pin; gray	www.wago.com/232-740/005-000
	Nr. articol: 232-742/005-000 THT female header; 0.6 x 1.0 mm solder pin; gray	www.wago.com/232-742/005-000
	Nr. articol: 232-832/005-000 THT female header; 0.6 x 1.0 mm solder pin; angled; Pin spacing 7.5 mm; 2-pole; gray	www.wago.com/232-832/005-000

Supus modificărilor.

	Nr. articol: 232-833/005-000 THT female header; 0.6 x 1.0 mm solder pin; angled; Pin spacing 7.5 mm; 3-pole; gray	www.wago.com/232-833/005-000
	Nr. articol: 232-834/005-000 THT female header; 0.6 x 1.0 mm solder pin; angled; Pin spacing 7.5 mm; 4-pole; gray	www.wago.com/232-834/005-000
	Nr. articol: 232-836/005-000 THT female header; 0.6 x 1.0 mm solder pin; angled; Pin spacing 7.5 mm; 6-pole; gray	www.wago.com/232-836/005-000
	Nr. articol: 232-836/005-000/039-000 THT female header; 0.6 x 1.0 mm solder pin; angled; Locking lever; Pin spacing 7.5 mm; 6-pole; gray	www.wago.com/232-836/005-000/039-000
	Nr. articol: 232-840/005-000 THT female header; 0.6 x 1.0 mm solder pin; angled; Pin spacing 7.5 mm; 10-pole; gray	www.wago.com/232-840/005-000
	Nr. articol: 232-842/005-000 THT female header; 0.6 x 1.0 mm solder pin; angled; Pin spacing 7.5 mm; 12-pole; gray	www.wago.com/232-842/005-000
	Nr. articol: 722-132/005-000 Female connector for rail-mount terminal blocks; 0.6 x 1 mm pins; straight; 100% protected against mismatching; Pin spacing 5 mm; 2-pole; light gray	www.wago.com/722-132/005-000
	Nr. articol: 722-132/005-000/039-000 Female connector for rail-mount terminal blocks; 0.6 x 1 mm pins; straight; 100% protected against mismatching; Locking lever; Pin spacing 5 mm; 2-pole; light gray	www.wago.com/722-132/005-000/039-000
	Nr. articol: 722-133/005-000 Female connector for rail-mount terminal blocks; 0.6 x 1 mm pins; straight; 100% protected against mismatching; Pin spacing 5 mm; 3-pole; light gray	www.wago.com/722-133/005-000
	Nr. articol: 722-133/005-000/039-000 Female connector for rail-mount terminal blocks; 0.6 x 1 mm pins; straight; 100% protected against mismatching; Locking lever; Pin spacing 5 mm; 3-pole; light gray	www.wago.com/722-133/005-000/039-000
	Nr. articol: 722-134/005-000 Female connector for rail-mount terminal blocks; 0.6 x 1 mm pins; straight; 100% protected against mismatching; Pin spacing 5 mm; 4-pole; light gray	www.wago.com/722-134/005-000
	Nr. articol: 722-134/005-000/039-000 Female connector for rail-mount terminal blocks; 0.6 x 1 mm pins; straight; 100% protected against mismatching; Locking lever; Pin spacing 5 mm; 4-pole; light gray	www.wago.com/722-134/005-000/039-000
	Nr. articol: 722-135/005-000 Female connector for rail-mount terminal blocks; 0.6 x 1 mm pins; straight; 100% protected against mismatching; Pin spacing 5 mm; 5-pole; light gray	www.wago.com/722-135/005-000
	Nr. articol: 722-135/005-000/039-000	













Supus modificărilor.

	Female connector for rail-mount terminal blocks; 0.6 x 1 mm pins; straight; 100% protected against mismatching; Locking lever; Pin spacing 5 mm; 5-pole; light gray	www.wago.com/722-135/005-000/039-000
	Nr. articol: 722-136/005-000 Female connector for rail-mount terminal blocks; 0.6 x 1 mm pins; straight; 100% protected against mismatching; Pin spacing 5 mm; 6-pole; light gray	www.wago.com/722-136/005-000
	Nr. articol: 722-136/005-000/039-000 Female connector for rail-mount terminal blocks; 0.6 x 1 mm pins; straight; 100% protected against mismatching; Locking lever; Pin spacing 5 mm; 6-pole; light gray	www.wago.com/722-136/005-000/039-000
	Nr. articol: 722-137/005-000 Female connector for rail-mount terminal blocks; 0.6 x 1 mm pins; straight; 100% protected against mismatching; Pin spacing 5 mm; 7-pole; light gray	www.wago.com/722-137/005-000
	Nr. articol: 722-137/005-000/039-000 Female connector for rail-mount terminal blocks; 0.6 x 1 mm pins; straight; 100% protected against mismatching; Locking lever; Pin spacing 5 mm; 7-pole; light gray	www.wago.com/722-137/005-000/039-000
	Nr. articol: 722-138/005-000 Female connector for rail-mount terminal blocks; 0.6 x 1 mm pins; straight; 100% protected against mismatching; Pin spacing 5 mm; 8-pole; light gray	www.wago.com/722-138/005-000
	Nr. articol: 722-138/005-000/039-000 Female connector for rail-mount terminal blocks; 0.6 x 1 mm pins; straight; 100% protected against mismatching; Locking lever; Pin spacing 5 mm; 8-pole; light gray	www.wago.com/722-138/005-000/039-000
	Nr. articol: 722-139/005-000 Female connector for rail-mount terminal blocks; 0.6 x 1 mm pins; straight; 100% protected against mismatching; Pin spacing 5 mm; 9-pole; light gray	www.wago.com/722-139/005-000
	Nr. articol: 722-139/005-000/039-000 Female connector for rail-mount terminal blocks; 0.6 x 1 mm pins; straight; 100% protected against mismatching; Locking lever; Pin spacing 5 mm; 9-pole; light gray	www.wago.com/722-139/005-000/039-000
	Nr. articol: 722-140/005-000 Female connector for rail-mount terminal blocks; 0.6 x 1 mm pins; straight; 100% protected against mismatching; Pin spacing 5 mm; 10-pole; light gray	www.wago.com/722-140/005-000
	Nr. articol: 722-140/005-000/039-000 Female connector for rail-mount terminal blocks; 0.6 x 1 mm pins; straight; 100% protected against mismatching; Locking lever; Pin spacing 5 mm; 10-pole; light gray	www.wago.com/722-140/005-000/039-000
	Nr. articol: 722-141/005-000 Female connector for rail-mount terminal blocks; 0.6 x 1 mm pins; straight; 100% protected against mismatching; Pin spacing 5 mm; 11-pole; light gray	www.wago.com/722-141/005-000
	Nr. articol: 722-142/005-000 Female connector for rail-mount terminal blocks; 0.6 x 1 mm pins; straight; 100% protected against mismatching; Pin spacing 5 mm; 12-pole; light gray	www.wago.com/722-142/005-000













Supus modificărilor.

WAGO Kontakttechnik GmbH & Co. KG
 /Representative Office Romania
 Sos. Pipera-Tunari nr. 1/1
 building 1, 2nd floor | 077190 Voluntari, Ilfov
 Tel.: +40-(0)31 421 85 68 | Email: info-RO@wago.com

Aveți întrebări despre produsele noastre?
 Vă stăm la dispoziție pentru preluarea apelului la +40 (0) 31 421 85 68.













	Nr. articol: 722-142/005-007/039-000 Female connector for rail-mount terminal blocks; gray	www.wago.com/722-142/005-007/039-000
	Nr. articol: 722-143/005-000 Female connector for rail-mount terminal blocks; 0.6 x 1 mm pins; straight; 100% protected against mismatching; Pin spacing 5 mm; 13-pole; light gray	www.wago.com/722-143/005-000
	Nr. articol: 722-144/005-000 Female connector for rail-mount terminal blocks; 0.6 x 1 mm pins; straight; 100% protected against mismatching; Pin spacing 5 mm; 14-pole; light gray	www.wago.com/722-144/005-000
	Nr. articol: 722-144/005-000/039-000 Female connector for rail-mount terminal blocks; 0.6 x 1 mm pins; straight; 100% protected against mismatching; Locking lever; Pin spacing 5 mm; 14-pole; light gray	www.wago.com/722-144/005-000/039-000
	Nr. articol: 722-145/005-000 Female connector for rail-mount terminal blocks; 0.6 x 1 mm pins; straight; 100% protected against mismatching; Pin spacing 5 mm; 15-pole; light gray	www.wago.com/722-145/005-000
	Nr. articol: 722-146/005-000 Female connector for rail-mount terminal blocks; 0.6 x 1 mm pins; straight; 100% protected against mismatching; Pin spacing 5 mm; 16-pole; light gray	www.wago.com/722-146/005-000
	Nr. articol: 722-146/005-000/039-000 Female connector for rail-mount terminal blocks; 0.6 x 1 mm pins; straight; 100% protected against mismatching; Locking lever; Pin spacing 5 mm; 16-pole; light gray	www.wago.com/722-146/005-000/039-000
	Nr. articol: 722-150/005-000 Female connector for rail-mount terminal blocks; 0.6 x 1 mm pins; straight; 100% protected against mismatching; Pin spacing 5 mm; 20-pole; light gray	www.wago.com/722-150/005-000
	Nr. articol: 722-150/005-000/039-000 Female connector for rail-mount terminal blocks; 0.6 x 1 mm pins; straight; 100% protected against mismatching; Locking lever; Pin spacing 5 mm; 20-pole; light gray	www.wago.com/722-150/005-000/039-000
	Nr. articol: 722-232/005-000 Female connector for rail-mount terminal blocks; 0.6 x 1 mm pins; angled; 100% protected against mismatching; Pin spacing 5 mm; 2-pole; light gray	www.wago.com/722-232/005-000
	Nr. articol: 722-232/005-000/039-000 Female connector for rail-mount terminal blocks; 0.6 x 1 mm pins; angled; 100% protected against mismatching; Locking lever; Pin spacing 5 mm; 2-pole; light gray	www.wago.com/722-232/005-000/039-000
	Nr. articol: 722-233/005-000 Female connector for rail-mount terminal blocks; 0.6 x 1 mm pins; angled; 100% protected against mismatching; Pin spacing 5 mm; 3-pole; light gray	www.wago.com/722-233/005-000
	Nr. articol: 722-233/005-000/039-000 Female connector for rail-mount terminal blocks; 0.6 x 1 mm pins; angled; 100% protected against mismatching; Locking lever; Pin spacing 5 mm; 3-pole; light gray	www.wago.com/722-233/005-000/039-000
	Nr. articol: 722-234/005-000	

Supus modificărilor.

	Female connector for rail-mount terminal blocks; 0.6 x 1 mm pins; angled; 100% protected against mismatching; Pin spacing 5 mm; 4-pole; light gray	www.wago.com/722-234/005-000
	Nr. articol: 722-234/005-000/039-000 Female connector for rail-mount terminal blocks; 0.6 x 1 mm pins; angled; 100% protected against mismatching; Locking lever; Pin spacing 5 mm; 4-pole; light gray	www.wago.com/722-234/005-000/039-000
	Nr. articol: 722-235/005-000 Female connector for rail-mount terminal blocks; 0.6 x 1 mm pins; angled; 100% protected against mismatching; Pin spacing 5 mm; 5-pole; light gray	www.wago.com/722-235/005-000
	Nr. articol: 722-235/005-000/039-000 Female connector for rail-mount terminal blocks; 0.6 x 1 mm pins; angled; 100% protected against mismatching; Locking lever; Pin spacing 5 mm; 5-pole; light gray	www.wago.com/722-235/005-000/039-000
	Nr. articol: 722-236/005-000 Female connector for rail-mount terminal blocks; 0.6 x 1 mm pins; angled; 100% protected against mismatching; Pin spacing 5 mm; 6-pole; light gray	www.wago.com/722-236/005-000
	Nr. articol: 722-236/005-000/039-000 Female connector for rail-mount terminal blocks; 0.6 x 1 mm pins; angled; 100% protected against mismatching; Locking lever; Pin spacing 5 mm; 6-pole; light gray	www.wago.com/722-236/005-000/039-000
	Nr. articol: 722-237/005-000 Female connector for rail-mount terminal blocks; 0.6 x 1 mm pins; angled; 100% protected against mismatching; Pin spacing 5 mm; 7-pole; light gray	www.wago.com/722-237/005-000
	Nr. articol: 722-237/005-000/039-000 Female connector for rail-mount terminal blocks; 0.6 x 1 mm pins; angled; 100% protected against mismatching; Locking lever; Pin spacing 5 mm; 7-pole; light gray	www.wago.com/722-237/005-000/039-000
	Nr. articol: 722-238/005-000 Female connector for rail-mount terminal blocks; 0.6 x 1 mm pins; angled; 100% protected against mismatching; Pin spacing 5 mm; 8-pole; light gray	www.wago.com/722-238/005-000
	Nr. articol: 722-239/005-000 Female connector for rail-mount terminal blocks; 0.6 x 1 mm pins; angled; 100% protected against mismatching; Pin spacing 5 mm; 9-pole; light gray	www.wago.com/722-239/005-000
	Nr. articol: 722-239/005-000/039-000 Female connector for rail-mount terminal blocks; 0.6 x 1 mm pins; angled; 100% protected against mismatching; Locking lever; Pin spacing 5 mm; 9-pole; light gray	www.wago.com/722-239/005-000/039-000
	Nr. articol: 722-240/005-000 Female connector for rail-mount terminal blocks; 0.6 x 1 mm pins; angled; 100% protected against mismatching; Pin spacing 5 mm; 10-pole; light gray	www.wago.com/722-240/005-000
	Nr. articol: 722-240/005-000/039-000 Female connector for rail-mount terminal blocks; 0.6 x 1 mm pins; angled; 100% protected against mismatching; Locking lever; Pin spacing 5 mm; 10-pole; light gray	www.wago.com/722-240/005-000/039-000

Nr. articol: 722-241/005-000



Supus modificărilor.

	Female connector for rail-mount terminal blocks; 0.6 x 1 mm pins; angled; 100% protected against mismatching; Pin spacing 5 mm; 11-pole; light gray	www.wago.com/722-241/005-000
	Nr. articol: 722-242/005-000 Female connector for rail-mount terminal blocks; 0.6 x 1 mm pins; angled; 100% protected against mismatching; Pin spacing 5 mm; 12-pole; light gray	www.wago.com/722-242/005-000
	Nr. articol: 722-242/005-000/039-000 Female connector for rail-mount terminal blocks; 0.6 x 1 mm pins; angled; 100% protected against mismatching; Locking lever; Pin spacing 5 mm; 12-pole; light gray	www.wago.com/722-242/005-000/039-000
	Nr. articol: 722-243/005-000 Female connector for rail-mount terminal blocks; 0.6 x 1 mm pins; angled; 100% protected against mismatching; Pin spacing 5 mm; 13-pole; light gray	www.wago.com/722-243/005-000
	Nr. articol: 722-244/005-000 Female connector for rail-mount terminal blocks; 0.6 x 1 mm pins; angled; 100% protected against mismatching; Pin spacing 5 mm; 14-pole; light gray	www.wago.com/722-244/005-000
	Nr. articol: 722-244/005-000/039-000 Female connector for rail-mount terminal blocks; 0.6 x 1 mm pins; angled; 100% protected against mismatching; Locking lever; Pin spacing 5 mm; 14-pole; light gray	www.wago.com/722-244/005-000/039-000
	Nr. articol: 722-246/005-000 Female connector for rail-mount terminal blocks; 0.6 x 1 mm pins; angled; 100% protected against mismatching; Pin spacing 5 mm; 16-pole; light gray	www.wago.com/722-246/005-000
	Nr. articol: 722-246/005-000/039-000 Female connector for rail-mount terminal blocks; 0.6 x 1 mm pins; angled; 100% protected against mismatching; Locking lever; Pin spacing 5 mm; 16-pole; light gray	www.wago.com/722-246/005-000/039-000
	Nr. articol: 722-250/005-000 Female connector for rail-mount terminal blocks; 0.6 x 1 mm pins; angled; 100% protected against mismatching; Pin spacing 5 mm; 20-pole; light gray	www.wago.com/722-250/005-000
General accessories		
	Nr. articol: 231-162/003-000 Male connector for rail-mount terminal blocks; 1.2 x 1.2 mm pins; straight; Pin spacing 5 mm; 2-pole; gray	www.wago.com/231-162/003-000
	Nr. articol: 231-163/003-000 Male connector for rail-mount terminal blocks; 1.2 x 1.2 mm pins; straight; Pin spacing 5 mm; 3-pole; gray	www.wago.com/231-163/003-000
	Nr. articol: 231-164/003-000 Male connector for rail-mount terminal blocks; 1.2 x 1.2 mm pins; straight; Pin spacing 5 mm; 4-pole; gray	www.wago.com/231-164/003-000
	Nr. articol: 231-165/003-000 Male connector for rail-mount terminal blocks; 1.2 x 1.2 mm pins; straight; Pin spacing 5 mm; 5-pole; gray	www.wago.com/231-165/003-000





Supus modificărilor.

WAGO Kontakttechnik GmbH & Co. KG
 /Representative Office Romania
 Sos. Pipera-Tunari nr. 1/1
 building 1, 2nd floor | 077190 Voluntari, Ilfov
 Tel.: +40-(0)31 421 85 68 | Email: info-RO@wago.com

Aveți întrebări despre produsele noastre?
 Vă stăm la dispoziție pentru preluarea apelului la +40 (0) 31 421 85 68.















	Nr. articol: 231-166/003-000 Male connector for rail-mount terminal blocks; 1.2 x 1.2 mm pins; straight; Pin spacing 5 mm; 6-pole; gray	www.wago.com/231-166/003-000
	Nr. articol: 231-167/003-000 Male connector for rail-mount terminal blocks; 1.2 x 1.2 mm pins; straight; Pin spacing 5 mm; 7-pole; gray	www.wago.com/231-167/003-000
	Nr. articol: 231-168/003-000 Male connector for rail-mount terminal blocks; 1.2 x 1.2 mm pins; straight; Pin spacing 5 mm; 8-pole; gray	www.wago.com/231-168/003-000
	Nr. articol: 231-169/003-000 Male connector for rail-mount terminal blocks; 1.2 x 1.2 mm pins; straight; Pin spacing 5 mm; 9-pole; gray	www.wago.com/231-169/003-000
	Nr. articol: 231-170/003-000 Male connector for rail-mount terminal blocks; 1.2 x 1.2 mm pins; straight; Pin spacing 5 mm; 10-pole; gray	www.wago.com/231-170/003-000
	Nr. articol: 231-171/003-000 Male connector for rail-mount terminal blocks; 1.2 x 1.2 mm pins; straight; Pin spacing 5 mm; 11-pole; gray	www.wago.com/231-171/003-000
	Nr. articol: 231-172/003-000 Male connector for rail-mount terminal blocks; 1.2 x 1.2 mm pins; straight; Pin spacing 5 mm; 12-pole; gray	www.wago.com/231-172/003-000
	Nr. articol: 231-176/003-000 Male connector for rail-mount terminal blocks; 1.2 x 1.2 mm pins; straight; Pin spacing 5 mm; 16-pole; gray	www.wago.com/231-176/003-000
	Nr. articol: 231-180/003-000 Male connector for rail-mount terminal blocks; 1.2 x 1.2 mm pins; straight; Pin spacing 5 mm; 20-pole; gray	www.wago.com/231-180/003-000

Marking accessories















	Nr. articol: 2009-115 WMB-Inline; for Smart Printer; 1500 pieces on roll; stretchable 5 - 5.2 mm; plain; snap-on type; white	www.wago.com/2009-115
	Nr. articol: 2009-115/000-002 WMB-Inline; for Smart Printer; 1500 pieces on roll; stretchable 5 - 5.2 mm; plain; snap-on type; yellow	www.wago.com/2009-115/000-002
	Nr. articol: 2009-115/000-006 WMB-Inline; for Smart Printer; 1500 pieces on roll; stretchable 5 - 5.2 mm; plain; snap-on type; blue	www.wago.com/2009-115/000-006
	Nr. articol: 2009-115/000-007 WMB-Inline; for Smart Printer; 1500 pieces on roll; stretchable 5 - 5.2 mm; plain; snap-on type; gray	www.wago.com/2009-115/000-007

Nr. articol: 2009-115/000-012















Supus modificărilor.

	WMB-Inline; for Smart Printer; 1500 pieces on roll; stretchable 5 - 5.2 mm; plain; snap-on type; orange	www.wago.com/2009-115/000-012
	Nr. articol: 2009-115/000-017 WMB-Inline; for Smart Printer; 1500 pieces on roll; stretchable 5 - 5.2 mm; plain; snap-on type; light green	www.wago.com/2009-115/000-017
	Nr. articol: 2009-115/000-023 WMB-Inline; for Smart Printer; 1500 pieces on roll; stretchable 5 - 5.2 mm; plain; snap-on type; green	www.wago.com/2009-115/000-023
	Nr. articol: 2009-115/000-024 WMB-Inline; for Smart Printer; 1500 pieces on roll; stretchable 5 - 5.2 mm; plain; snap-on type; violet	www.wago.com/2009-115/000-024
	Nr. articol: 2009-145 Mini-WSB Inline; for Smart Printer; 1700 pieces on roll; stretchable 5 - 5.2 mm; plain; snap-on type; white	www.wago.com/2009-145/000-000
	Nr. articol: 2009-145/000-002 Mini-WSB Inline; for Smart Printer; 1700 pieces on roll; stretchable 5 - 5.2 mm; plain; snap-on type; yellow	www.wago.com/2009-145/000-002
	Nr. articol: 2009-145/000-005 Mini-WSB Inline; for Smart Printer; 1700 pieces on roll; stretchable 5 - 5.2 mm; plain; snap-on type; red	www.wago.com/2009-145/000-005
	Nr. articol: 2009-145/000-006 Mini-WSB Inline; for Smart Printer; 1700 pieces on roll; stretchable 5 - 5.2 mm; plain; snap-on type; blue	www.wago.com/2009-145/000-006
	Nr. articol: 2009-145/000-007 Mini-WSB Inline; for Smart Printer; 1700 pieces on roll; stretchable 5 - 5.2 mm; plain; snap-on type; gray	www.wago.com/2009-145/000-007
	Nr. articol: 2009-145/000-012 Mini-WSB Inline; for Smart Printer; 1700 pieces on roll; stretchable 5 - 5.2 mm; plain; snap-on type; orange	www.wago.com/2009-145/000-012
	Nr. articol: 2009-145/000-023 Mini-WSB Inline; for Smart Printer; 1700 pieces on roll; stretchable 5 - 5.2 mm; plain; snap-on type; green	www.wago.com/2009-145/000-023
	Nr. articol: 2009-145/000-024 Mini-WSB Inline; for Smart Printer; 1700 pieces on roll; stretchable 5 - 5.2 mm; plain; snap-on type; violet	www.wago.com/2009-145/000-024
	Nr. articol: 248-501 Miniature WSB Quick marking system; plain; Marker width 5 mm; 10 strips with 10 markers per card	www.wago.com/248-501/000-000
	Nr. articol: 248-501/000-002 Mini-WSB marking card; as card; not stretchable; plain; snap-on type; yellow	www.wago.com/248-501/000-002





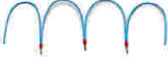











Supus modificărilor.

	Nr. articol: 248-501/000-005 Mini-WSB marking card; as card; not stretchable; plain; snap-on type; red	www.wago.com/248-501/000-005
	Nr. articol: 248-501/000-006 Mini-WSB marking card; as card; not stretchable; plain; snap-on type; blue	www.wago.com/248-501/000-006
	Nr. articol: 248-501/000-007 Mini-WSB marking card; as card; not stretchable; plain; snap-on type; gray	www.wago.com/248-501/000-007
	Nr. articol: 248-501/000-012 Mini-WSB marking card; as card; not stretchable; plain; snap-on type; orange	www.wago.com/248-501/000-012
	Nr. articol: 248-501/000-017 Mini-WSB marking card; as card; not stretchable; plain; snap-on type; light green	www.wago.com/248-501/000-017
	Nr. articol: 248-501/000-023 Mini-WSB marking card; as card; not stretchable; plain; snap-on type; green	www.wago.com/248-501/000-023
	Nr. articol: 248-501/000-024 Mini-WSB marking card; as card; not stretchable; plain; snap-on type; violet	www.wago.com/248-501/000-024
	Nr. articol: 793-501 WMB marking card; as card; not stretchable; plain; snap-on type; white	www.wago.com/793-501
	Nr. articol: 793-501/000-002 WMB marking card; as card; not stretchable; plain; snap-on type; yellow	www.wago.com/793-501/000-002
	Nr. articol: 793-501/000-005 WMB marking card; as card; not stretchable; plain; snap-on type; red	www.wago.com/793-501/000-005
	Nr. articol: 793-501/000-006 WMB marking card; as card; not stretchable; plain; snap-on type; blue	www.wago.com/793-501/000-006
	Nr. articol: 793-501/000-007 WMB marking card; as card; not stretchable; plain; snap-on type; gray	www.wago.com/793-501/000-007
	Nr. articol: 793-501/000-012 WMB marking card; as card; not stretchable; plain; snap-on type; orange	www.wago.com/793-501/000-012
	Nr. articol: 793-501/000-017 WMB marking card; as card; not stretchable; plain; snap-on type; light green	www.wago.com/793-501/000-017

Supus modificărilor.

	Nr. articol: 793-501/000-023 WMB marking card; as card; not stretchable; plain; snap-on type; green	www.wago.com/793-501/000-023
	Nr. articol: 793-501/000-024 WMB marking card; as card; not stretchable; plain; snap-on type; violet	www.wago.com/793-501/000-024
	Nr. articol: 793-5501 WMB marking card; as card; for terminal block width 5 - 17.5 mm; stretchable 5 - 5.2 mm; plain; snap-on type; white	www.wago.com/793-5501
	Nr. articol: 793-5501/000-002 WMB marking card; as card; for terminal block width 5 - 17.5 mm; stretchable 5 - 5.2 mm; plain; snap-on type; yellow	www.wago.com/793-5501/000-002
	Nr. articol: 793-5501/000-005 WMB marking card; as card; for terminal block width 5 - 17.5 mm; stretchable 5 - 5.2 mm; plain; snap-on type; red	www.wago.com/793-5501/000-005
	Nr. articol: 793-5501/000-006 WMB marking card; as card; for terminal block width 5 - 17.5 mm; stretchable 5 - 5.2 mm; plain; snap-on type; blue	www.wago.com/793-5501/000-006
	Nr. articol: 793-5501/000-007 WMB marking card; as card; for terminal block width 5 - 17.5 mm; stretchable 5 - 5.2 mm; plain; snap-on type; gray	www.wago.com/793-5501/000-007
	Nr. articol: 793-5501/000-012 WMB marking card; as card; for terminal block width 5 - 17.5 mm; stretchable 5 - 5.2 mm; plain; snap-on type; orange	www.wago.com/793-5501/000-012
	Nr. articol: 793-5501/000-017 WMB marking card; as card; for terminal block width 5 - 17.5 mm; stretchable 5 - 5.2 mm; plain; snap-on type; green	www.wago.com/793-5501/000-017
	Nr. articol: 793-5501/000-023 WMB marking card; as card; for terminal block width 5 - 17.5 mm; stretchable 5 - 5.2 mm; plain; snap-on type; light green	www.wago.com/793-5501/000-023
	Nr. articol: 793-5501/000-024 WMB marking card; as card; for terminal block width 5 - 17.5 mm; stretchable 5 - 5.2 mm; plain; snap-on type; violet	www.wago.com/793-5501/000-024
Jumper		
	Nr. articol: 210-103 Wire commoning chain; insulated; 50 connections; black	www.wago.com/210-103
	Nr. articol: 210-123 Wire commoning chain; insulated; 50 connections	www.wago.com/210-123
	Nr. articol: 249-123 Push-in type wire jumper; insulated; wire length 180 mm; Conductor cross section 0.75 mm ²	www.wago.com/249-123

Supus modificărilor.

	Nr. articol: 249-125 Push-in type wire jumper; insulated; wire length 60 mm; Conductor cross section 0.75 mm ²	www.wago.com/249-125
	Nr. articol: 249-126 Push-in type wire jumper; insulated; wire length 110 mm; Conductor cross section 0.75 mm ²	www.wago.com/249-126
	Nr. articol: 249-127 Push-in type wire jumper; insulated; wire length 250 mm; Conductor cross section 0.75 mm ²	www.wago.com/249-127
	Nr. articol: 280-482 Comb-style jumper bar; insulated; 2-way; IN = IN terminal block; gray	www.wago.com/280-482
	Nr. articol: 280-483 Comb-style jumper bar; insulated; 3-way; IN = IN terminal block; gray	www.wago.com/280-483
	Nr. articol: 280-484 Comb-style jumper bar; insulated; 4-way; IN = IN terminal block; gray	www.wago.com/280-484
	Nr. articol: 280-485 Comb-style jumper bar; insulated; 5-way; IN = IN terminal block; gray	www.wago.com/280-485
	Nr. articol: 280-490 Comb-style jumper bar; insulated; 10-way; IN = IN terminal block; gray	www.wago.com/280-490
	Nr. articol: 280-492 Alternate comb-style jumper bar; insulated; 2-way; IN = IN terminal block; gray	www.wago.com/280-492
	Nr. articol: 709-110 Wire commoning chain; insulated; 4 connections; 3 x 110 mm; black	www.wago.com/709-110
	Nr. articol: 709-111 Wire commoning chain; insulated; 3 connections; 2 x 120 mm; black	www.wago.com/709-111
	Nr. articol: 709-112 Wire commoning chain; insulated; 3 connections; 2 x 170 mm; black	www.wago.com/709-112
tools		
	Nr. articol: 210-657 Operating tool; Blade: 3.5 x 0.5 mm; with a partially insulated shaft; short	www.wago.com/210-657
	Nr. articol: 210-658 Operating tool; Blade: 3.5 x 0.5 mm; with a partially insulated shaft; angled; short	www.wago.com/210-658
	Nr. articol: 210-720 Operating tool; Blade: 3.5 x 0.5 mm; with a partially insulated shaft	www.wago.com/210-720
End plate		
	Nr. articol: 280-373 End and intermediate plate; 2.5 mm thick; orange	www.wago.com/280-373
	Nr. articol: 280-376 End and intermediate plate; 2.5 mm thick; gray	www.wago.com/280-376

Supus modificărilor.

Descărcări Documentation

Additional Information

Technical explanations	Apr 3, 2019	pdf 2,1 MB	Descărcare
------------------------	-------------	---------------	------------

CAD/CAE-Data

CAE data

EPLAN Data Portal 280-875	URL	Descărcare
WSCAD Universe 280-875	URL	Descărcare

Installation Notes

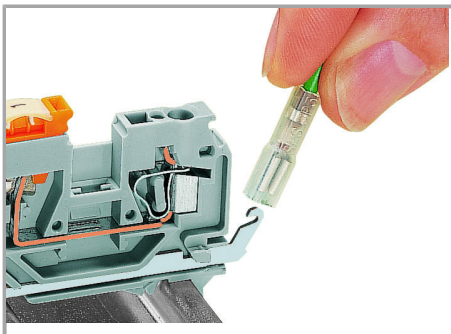

Shield contact via (2.5 x 0.8) mm solder
/crimp quick disconnect terminal

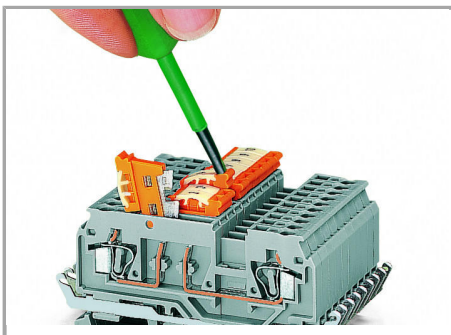

Pivoting a knife disconnect.

Supus modificărilor.

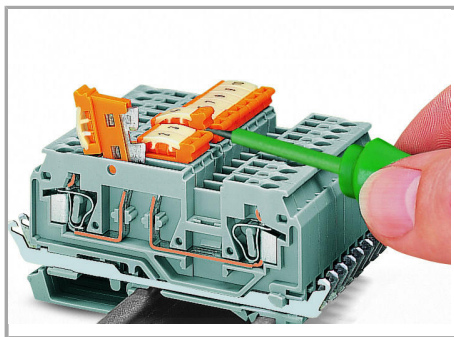

Pivoting knife disconnect clearly indicates circuit state by defined, notched positions "ON" <—> "OFF."

Testing

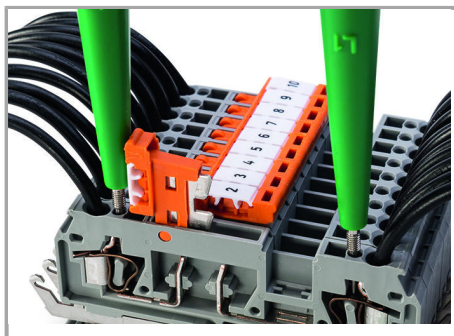

Testing with voltage tester.

Marking

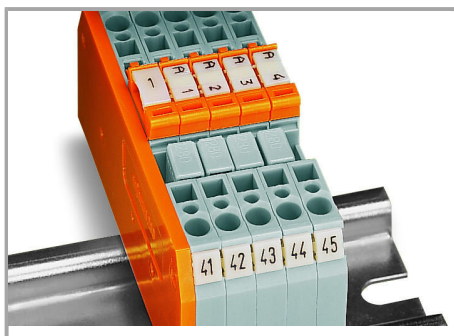

Terminal block labeling – via WMB (center position) and Mini-WSB markers (on the sides)

Supus modificărilor.