

Fișă tehnică | Număr articol: 2200-1204

2-conductor through terminal block; with push-button; 1 mm²; with test port; suitable for Ex i applications; side and center marking; for DIN-rail 35 x 15 and 35 x 7.5; Push-in CAGE CLAMP®; 1,00 mm²; blue

www.wago.com/2200-1204

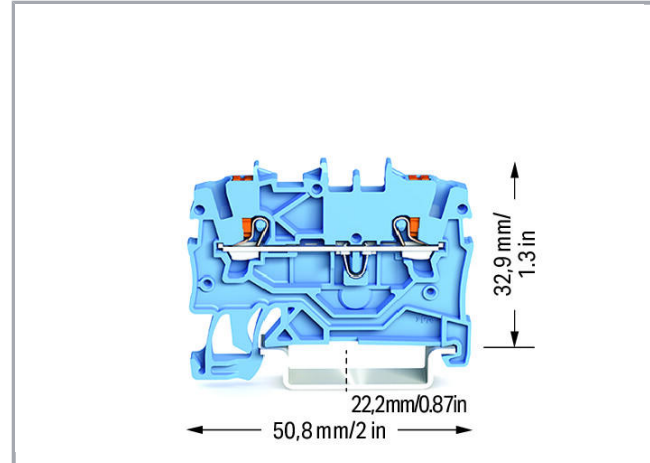
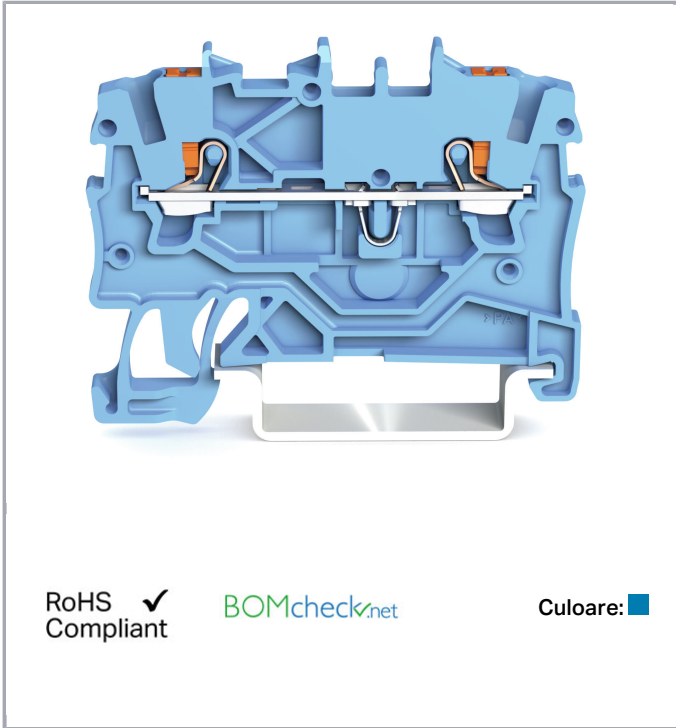

RoHS Compliant

BOMcheck.net

Culoare: ■

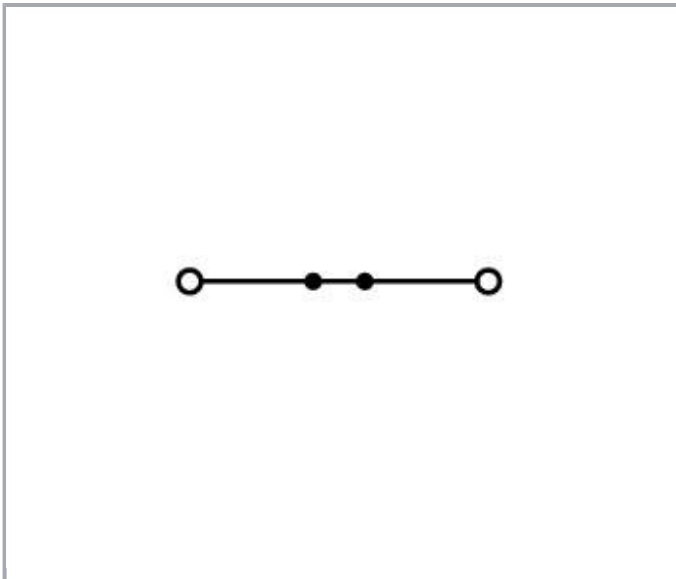

Date

Supus modificărilor.

WAGO Kontakttechnik GmbH & Co. KG
/Representative Office Romania
Sos. Pipera-Tunari nr. 1/1
building 1, 2nd floor | 077190 Voluntari, Ilfov
Tel.: +40-(0)31 421 85 68 | Email: info-RO@wago.com

Aveți întrebări despre produsele noastre?
Vă stăm la dispoziție pentru preluarea apelului la +40 (0) 31 421 85 68.



Electrical data

Ratings per IEC/EN 60664-1

Ratings per	IEC/EN 60947-7-1
Nominal voltage (III/3)	800 V
Rated surge voltage (III/3)	8 kV
Rated current	13,5 A
Rated current 2	17,5 A
Legend (ratings)	(III / 3) ≙ Overvoltage category III / Pollution degree 3

Approvals per UL 1059

Rated voltage UL (Use Group B)	600 V
Rated current UL (Use Group B)	10 A
Rated voltage UL (Use Group C)	600 V
Rated current UL (Use Group C)	10 A
Approvals per	UL 1059

Connection data

Connection technology	Push-in CAGE CLAMP®
Actuation type	Push-in Push-button
Connectable conductor materials	Copper
Nominal cross-section	1 mm ²
Solid conductor	0,14 ... 1,5 mm ² / 24 ... 16 AWG
Solid conductor; push-in termination	0,5 ... 1,5 mm ² / 20 ... 16 AWG
Fine-stranded conductor	0,14 ... 1,5 mm ² / 24 ... 16 AWG
Fine-stranded conductor; with insulated ferrule	0,5 ... 0,75 mm ² / 20 ... 18 AWG
Fine-stranded conductor; with ferrule; push-in termination	0,5 ... 0,75 mm ² / 20 ... 18 AWG
Strip length	9 ... 11 mm / 0.35 ... 0.43 inch
Total number of connection points	2
Total number of potentials	1
Number of levels	1
Wiring type	Front-entry wiring
Note (conductor cross-section)	Depending on the conductor characteristic, a conductor with a smaller cross-section can also be inserted via push-in termination.
Number of jumper slots	2

Supus modificărilor.

Geometrical Data

Width	3,5 mm / 0.138 inch
Height from upper-edge of DIN-rail	32,9 mm / 1.295 inch
Depth	48,5 mm / 1.909 inch

Mechanical data

Design	horizontal type
Mounting type	DIN-35 rail
Marking level	Center/side marking

Material Data



Color	blue
Insulation material	Polyamide 66 (PA 66)
Weight	3,5 g

Commercial data

Packaging type	BOX
Country of origin	DE
GTIN	4055143691581
Customs tariff number	85369010000

Aprobări / certificate

Ex-Approvals



Emblemă	Aprobare	Text de aprobare suplimentar	Nume certificat
	AEx Underwriters Laboratories Inc.	UL 60079	4788311594
	ATEX Physikalisch Technische Bundesanstalt	IEC 60079-0	PTB 18 ATEX 1003 U
	IECEX Physikalisch Technische Bundesanstalt	IEC 60079	IECEX PTB 18.0010U (Ex eb IIC Gb and Ex eb I Mb)

Supus modificărilor.



WAGO Kontakttechnik GmbH & Co. KG
/Representative Office Romania
Sos. Pipera-Tunari nr. 1/1
building 1, 2nd floor | 077190 Voluntari, Ilfov
Tel.: +40-(0)31 421 85 68 | Email: info-RO@wago.com

Aveți întrebări despre produsele noastre?
Vă stăm la dispoziție pentru preluarea apelului la +40 (0) 31 421 85 68.

Country specific Approvals

Emblemă	Aprobare	Text de aprobare suplimentar	Nume certificat
	CCA DEKRA Certification B.V.	EN 60947	NTR NL 7663
	CSA DEKRA Certification B.V.	C22.2	70173737
	KEMA/KEUR DEKRA Certification B.V.	IEC 60947	71- 102874

Ship Approvals

Emblemă	Aprobare	Text de aprobare suplimentar	Nume certificat
	ABS American Bureau of Shipping	-	19- HG1866350- PDA
	DNV GL Det Norske Veritas, Germanischer Lloyd	-	TAE00003JT
	LR Lloyds Register	-	19/20050

UL-Approvals

Emblemă	Aprobare	Text de aprobare suplimentar	Nume certificat
	cURus Underwriters Laboratories Inc.	UL 1059	4788311592













Counterpart

Supus modificărilor.

WAGO Kontakttechnik GmbH & Co. KG
/Representative Office Romania
Sos. Pipera-Tunari nr. 1/1
building 1, 2nd floor | 077190 Voluntari, Ilfov
Tel.: +40-(0)31 421 85 68 | Email: info-RO@wago.com

Aveți întrebări despre produsele noastre?
Vă stăm la dispoziție pentru preluarea apelului la +40 (0) 31 421 85 68.

















Produse compatibile

ferrule		
	Nr. articol: 216-241 Ferrule; Sleeve for 0.5 mm ² / 20 AWG; insulated; electro-tin plated; electrolytic copper; gastight crimped; acc. to DIN 46228, Part 4/09.90; white	www.wago.com/216-241
	Nr. articol: 216-242 Ferrule; Sleeve for 0.75 mm ² / 18 AWG; insulated; electro-tin plated; electrolytic copper; gastight crimped; acc. to DIN 46228, Part 4/09.90; gray	www.wago.com/216-242
	Nr. articol: 216-243 Ferrule; Sleeve for 1 mm ² / AWG 18; insulated; electro-tin plated; electrolytic copper; gastight crimped; acc. to DIN 46228, Part 4/09.90; red	www.wago.com/216-243
check		
	Nr. articol: 2000-510 TOPJOB®S L-type test plug module; modular; for jumper contact slot; 1,00 mm ² ; gray	www.wago.com/2000-510
	Nr. articol: 2000-511 TOPJOB®S L-type test plug module; modular; for jumper contact slot; 1-pole; 1,00 mm ² ; gray	www.wago.com/2000-511
	Nr. articol: 2000-549 Spacer module; modular; e.g., for bridging commoned terminal blocks; gray	www.wago.com/2000-549
	Nr. articol: 2000-552 Modular TOPJOB®S connector; modular; for jumper contact slot; 2-pole; 1,00 mm ² ; gray	www.wago.com/2000-552
	Nr. articol: 2000-553 Modular TOPJOB®S connector; modular; for jumper contact slot; 3-pole; 1,00 mm ² ; gray	www.wago.com/2000-553
	Nr. articol: 2000-554 Modular TOPJOB®S connector; modular; for jumper contact slot; 4-pole; 1,00 mm ² ; gray	www.wago.com/2000-554
	Nr. articol: 2000-555 Modular TOPJOB®S connector; modular; for jumper contact slot; 5-pole; 1,00 mm ² ; gray	www.wago.com/2000-555
	Nr. articol: 2000-556 Modular TOPJOB®S connector; modular; for jumper contact slot; 6-pole; 1,00 mm ² ; gray	www.wago.com/2000-556
	Nr. articol: 2000-557 Modular TOPJOB®S connector; modular; for jumper contact slot; 7-pole; 1,00 mm ² ; gray	www.wago.com/2000-557
	Nr. articol: 2000-558 Modular TOPJOB®S connector; modular; for jumper contact slot; 8-pole; 1,00 mm ² ; gray	www.wago.com/2000-558















Supus modificărilor.

WAGO Kontakttechnik GmbH & Co. KG
/Representative Office Romania
Sos. Pipera-Tunari nr. 1/1
building 1, 2nd floor | 077190 Voluntari, Ilfov
Tel.: +40-(0)31 421 85 68 | Email: info-RO@wago.com















Aveți întrebări despre produsele noastre?
Vă stăm la dispoziție pentru preluarea apelului la +40 (0) 31 421 85 68.

	Nr. articol: 2000-559 Modular TOPJOB®S connector; modular; for jumper contact slot; 9-pole; 1,00 mm ² ; gray	www.wago.com/2000-559
	Nr. articol: 2000-560 Modular TOPJOB®S connector; modular; for jumper contact slot; 10-pole; 1,00 mm ² ; gray	www.wago.com/2000-560
	Nr. articol: 2009-174 Test plug adapter; for 4 mm Ø test plugs; for testing TOPJOB®S rail-mounted terminal blocks; gray	www.wago.com/2009-174
	Nr. articol: 2009-182 Testing tap; for max. 2.5 mm ² ; tool-free connection for individual test wires 0.08 - 2.5 mm; gray	www.wago.com/2009-182
	Nr. articol: 210-136 Test plug; 2 mm Ø; with 500 mm cable; red	www.wago.com/210-136
	Nr. articol: 210-137 Test plug; 2.3 mm Ø; with 500 mm cable; yellow	www.wago.com/210-137
Carrier rail		
	Nr. articol: 210-112 Steel carrier rail; 35 x 7.5 mm; 1 mm thick; 2 m long; slotted; according to EN 60715; "Hole width 25 mm	www.wago.com/210-112
	Nr. articol: 210-113 Steel carrier rail; 35 x 7.5 mm; 1 mm thick; 2 m long; unslotted; according to EN 60715	www.wago.com/210-113
	Nr. articol: 210-114 Steel carrier rail; 35 x 15 mm; 1.5 mm thick; 2 m long; unslotted; similar to EN 60715	www.wago.com/210-114
	Nr. articol: 210-115 Steel carrier rail; 35 x 7.5 mm; 1 mm thick; 2 m long; slotted; according to EN 60715; "Hole width 18 mm	www.wago.com/210-115
	Nr. articol: 210-118 Steel carrier rail; 35 x 15 mm; 2.3 mm thick; 2 m long; unslotted; according to EN 60715	www.wago.com/210-118
	Nr. articol: 210-196 Aluminum carrier rail; 35 x 8.2 mm; 1.6 mm thick; 2 m long; unslotted; similar to EN 60715; silver-colored	www.wago.com/210-196
	Nr. articol: 210-197 Steel carrier rail; 35 x 15 mm; 1.5 mm thick; 2 m long; slotted; similar to EN 60715	www.wago.com/210-197
	Nr. articol: 210-198 Copper carrier rail; 35 x 15 mm; 2.3 mm thick; 2 m long; unslotted; according to EN 60715; copper-colored	www.wago.com/210-198
Marking accessories		
	Nr. articol: 2009-110 Marking strips; on reel; not stretchable; plain; snap-on type; white	www.wago.com/2009-110
	Nr. articol: 2009-113 WMB-Inline; for Smart Printer; 2300 pieces on roll; plain; snap-on type; white	www.wago.com/2009-113

Supus modificărilor.

	Nr. articol: 2009-113/000-002 WMB-Inline; for Smart Printer; 2300 pieces on roll; plain; snap-on type; yellow	www.wago.com/2009-113/000-002
	Nr. articol: 2009-113/000-005 WMB-Inline; for Smart Printer; 2300 pieces on roll; plain; snap-on type; red	www.wago.com/2009-113/000-005
	Nr. articol: 2009-113/000-006 WMB-Inline; for Smart Printer; 2300 pieces on roll; plain; snap-on type; blue	www.wago.com/2009-113/000-006
	Nr. articol: 2009-113/000-007 WMB-Inline; for Smart Printer; 2300 pieces on roll; plain; snap-on type; gray	www.wago.com/2009-113/000-007
	Nr. articol: 2009-113/000-012 WMB-Inline; for Smart Printer; 2300 pieces on roll; plain; snap-on type; orange	www.wago.com/2009-113/000-012
	Nr. articol: 2009-113/000-017 WMB-Inline; for Smart Printer; 2300 pieces on roll; plain; snap-on type; light green	www.wago.com/2009-113/000-017
	Nr. articol: 2009-113/000-023 WMB-Inline; for Smart Printer; 2300 pieces on roll; plain; snap-on type; green	www.wago.com/2009-113/000-023
	Nr. articol: 2009-113/000-024 WMB-Inline; for Smart Printer; 2300 pieces on roll; plain; snap-on type; violet	www.wago.com/2009-113/000-024
	Nr. articol: 793-3501 WMB marking card; as card; plain; snap-on type; white	www.wago.com/793-3501
tools		
	Nr. articol: 210-647 Operating tool; Blade: 2.5 x 0.4 mm; with a partially insulated shaft	www.wago.com/210-647
	Nr. articol: 210-648 Operating tool; Blade: 2.5 x 0.4 mm; with a partially insulated shaft; angled; short	www.wago.com/210-648
	Nr. articol: 210-719 Operating tool; Blade: 2.5 x 0.4 mm; with a partially insulated shaft	www.wago.com/210-719
Push-In type wire jumper		
	Nr. articol: 2009-402 Push-in type wire jumper; insulated; wire length 60 mm; Conductor cross section 0.75 mm ² ; suitable for 2000 and 2020 Series rail-mounted terminal blocks; gray	www.wago.com/2009-402
	Nr. articol: 2009-404 Push-in type wire jumper; insulated; wire length 110 mm; Conductor cross section 0.75 mm ² ; suitable for 2000 and 2020 Series rail-mounted terminal blocks; gray	www.wago.com/2009-404















Supus modificărilor.

	Nr. articol: 2009-406 Push-in type wire jumper; insulated; wire length 250 mm; Conductor cross section 0.75 mm ² ; suitable for 2000 and 2020 Series rail-mounted terminal blocks; gray	www.wago.com/2009-406
End plate		
	Nr. articol: 2000-1291 End and intermediate plate; 0.7 mm thick; gray	www.wago.com/2000-1291
	Nr. articol: 2000-1292 End and intermediate plate; 0.7 mm thick; orange	www.wago.com/2000-1292
Jumper		
	Nr. articol: 2000-402 Push-in type jumper bar; insulated; 2-way; Nominal current 14 A; light gray	www.wago.com/2000-402
	Nr. articol: 2000-402/000-005 Push-in type jumper bar; insulated; 2-way; Nominal current 14 A; red	www.wago.com/2000-402/000-005
	Nr. articol: 2000-402/000-006 Push-in type jumper bar; insulated; 2-way; Nominal current 14 A; blue	www.wago.com/2000-402/000-006
	Nr. articol: 2000-402/000-018 Push-in type jumper bar; insulated; 2-way; Nominal current 14 A; yellow-green	www.wago.com/2000-402/000-018
	Nr. articol: 2000-403 Push-in type jumper bar; insulated; 3-way; Nominal current 14 A; light gray	www.wago.com/2000-403
	Nr. articol: 2000-403/000-005 Push-in type jumper bar; insulated; 3-way; Nominal current 14 A; red	www.wago.com/2000-403/000-005
	Nr. articol: 2000-403/000-006 Push-in type jumper bar; insulated; 3-way; Nominal current 14 A; blue	www.wago.com/2000-403/000-006
	Nr. articol: 2000-404 Push-in type jumper bar; insulated; 4-way; Nominal current 14 A; light gray	www.wago.com/2000-404
	Nr. articol: 2000-404/000-005 Push-in type jumper bar; insulated; 4-way; Nominal current 14 A; red	www.wago.com/2000-404/000-005
	Nr. articol: 2000-404/000-006 Push-in type jumper bar; insulated; 4-way; Nominal current 14 A; blue	www.wago.com/2000-404/000-006
	Nr. articol: 2000-405 Push-in type jumper bar; insulated; 5-way; Nominal current 14 A; light gray	www.wago.com/2000-405

















Supus modificărilor.

WAGO Kontakttechnik GmbH & Co. KG
/Representative Office Romania
Sos. Pipera-Tunari nr. 1/1
building 1, 2nd floor | 077190 Voluntari, Ilfov
Tel.: +40-(0)31 421 85 68 | Email: info-RO@wago.com

Aveți întrebări despre produsele noastre?
Vă stăm la dispoziție pentru preluarea apelului la +40 (0) 31 421 85 68.

	Nr. articol: 2000-405/000-005 Push-in type jumper bar; insulated; 5-way; Nominal current 14 A; red	www.wago.com/2000-405/000-005
	Nr. articol: 2000-405/000-006 Push-in type jumper bar; insulated; 5-way; Nominal current 14 A; blue	www.wago.com/2000-405/000-006
	Nr. articol: 2000-405/011-000 Star point jumper; insulated; 3-way (1-3-5); IN = IN terminal block; light gray	www.wago.com/2000-405/011-000
	Nr. articol: 2000-406 Push-in type jumper bar; insulated; 6-way; Nominal current 14 A; light gray	www.wago.com/2000-406
	Nr. articol: 2000-406/000-005 Push-in type jumper bar; insulated; 6-way; Nominal current 14 A; red	www.wago.com/2000-406/000-005
	Nr. articol: 2000-406/000-006 Push-in type jumper bar; insulated; 6-way; Nominal current 14 A; blue	www.wago.com/2000-406/000-006
	Nr. articol: 2000-406/020-000 Delta jumper; insulated; 1-2 3-4 5-6; IN = IN terminal block; light gray	www.wago.com/2000-406/020-000
	Nr. articol: 2000-407 Push-in type jumper bar; insulated; 7-way; Nominal current 14 A; light gray	www.wago.com/2000-407
	Nr. articol: 2000-407/000-005 Push-in type jumper bar; insulated; 7-way; Nominal current 14 A; red	www.wago.com/2000-407/000-005
	Nr. articol: 2000-407/000-006 Push-in type jumper bar; insulated; 7-way; Nominal current 14 A; blue	www.wago.com/2000-407/000-006
	Nr. articol: 2000-408 Push-in type jumper bar; insulated; 8-way; Nominal current 14 A; light gray	www.wago.com/2000-408
	Nr. articol: 2000-408/000-005 Push-in type jumper bar; insulated; 8-way; Nominal current 14 A; red	www.wago.com/2000-408/000-005
	Nr. articol: 2000-408/000-006 Push-in type jumper bar; insulated; 8-way; Nominal current 14 A; blue	www.wago.com/2000-408/000-006
	Nr. articol: 2000-409 Push-in type jumper bar; insulated; 9-way; Nominal current 14 A; light gray	www.wago.com/2000-409

Supus modificărilor.

	Nr. articol: 2000-409/000-005 Push-in type jumper bar; insulated; 9-way; Nominal current 14 A; red	www.wago.com/2000-409/000-005
	Nr. articol: 2000-409/000-006 Push-in type jumper bar; insulated; 9-way; Nominal current 14 A; blue	www.wago.com/2000-409/000-006
	Nr. articol: 2000-410 Push-in type jumper bar; insulated; 10-way; Nominal current 14 A; light gray	www.wago.com/2000-410
	Nr. articol: 2000-410/000-005 Push-in type jumper bar; insulated; 10-way; Nominal current 14 A; red	www.wago.com/2000-410/000-005
	Nr. articol: 2000-410/000-006 Push-in type jumper bar; insulated; 10-way; Nominal current 14 A; blue	www.wago.com/2000-410/000-006
	Nr. articol: 2000-433 Push-in type jumper bar; insulated; from 1 to 3; Nominal current 14 A; light gray	www.wago.com/2000-433
	Nr. articol: 2000-433/000-005 Push-in type jumper bar; insulated; from 1 to 3; Nominal current 14 A; red	www.wago.com/2000-433/000-005
	Nr. articol: 2000-433/000-006 Push-in type jumper bar; insulated; from 1 to 3; Nominal current 14 A; blue	www.wago.com/2000-433/000-006
	Nr. articol: 2000-434 Push-in type jumper bar; insulated; from 1 to 4; Nominal current 14 A; light gray	www.wago.com/2000-434
	Nr. articol: 2000-435 Push-in type jumper bar; insulated; from 1 to 5; Nominal current 14 A; light gray	www.wago.com/2000-435
	Nr. articol: 2000-436 Push-in type jumper bar; insulated; from 1 to 6; Nominal current 14 A; light gray	www.wago.com/2000-436
	Nr. articol: 2000-437 Push-in type jumper bar; insulated; from 1 to 7; Nominal current 14 A; light gray	www.wago.com/2000-437
	Nr. articol: 2000-438 Push-in type jumper bar; insulated; from 1 to 8; Nominal current 14 A; light gray	www.wago.com/2000-438
	Nr. articol: 2000-439 Push-in type jumper bar; insulated; from 1 to 9; Nominal current 14 A; light gray	www.wago.com/2000-439
	Nr. articol: 2000-440 Push-in type jumper bar; insulated; from 1 to 10; Nominal current 14 A; light gray	www.wago.com/2000-440
	Nr. articol: 210-103 Wire commoning chain; insulated; 50 connections; black	www.wago.com/210-103

Supus modificărilor.

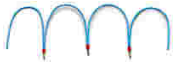

Nr. articol: 210-123

Wire commoning chain; insulated; 50 connections

www.wago.com/210-123

Descărcări

Documentation

Additional Information

Technical explanations

Apr 3, 2019

pdf
2,1 MB

[Descărcare](#)

CAD/CAE-Data

CAD data

2D/3D Models 2200-1204

[URL](#)

[Descărcare](#)

CAE data

EPLAN Data Portal 2200-1204

[URL](#)

[Descărcare](#)

Installation Notes

Conductor termination

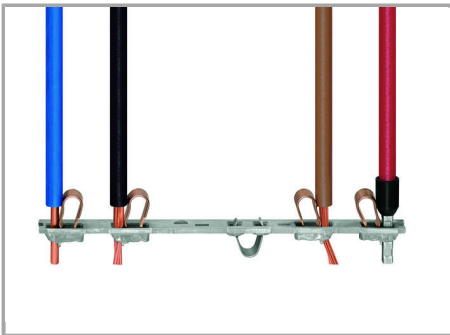

All conductor types at a glance

Familie de produse

TOPJOB® S

TOPJOB® S: In various industrial applications and modern building installations, WAGO's wide and versatile range of rail-mount terminal blocks provides more than just reliable electrical connections.

[Afișare globală produse din familie.](#)

Supus modificărilor.