

## Fișă tehnică | Număr articol: 2002-2602

Double-deck terminal block; Through/through terminal block; same profile as double-deck disconnect terminal block; N/L; without marker carrier; Blue conductor entry lower deck; for DIN-rail 35 x 15 and 35 x 7.5; 2.5 mm<sup>2</sup>; Push-in CAGE CLAMP®; 2,50 mm<sup>2</sup>; gray

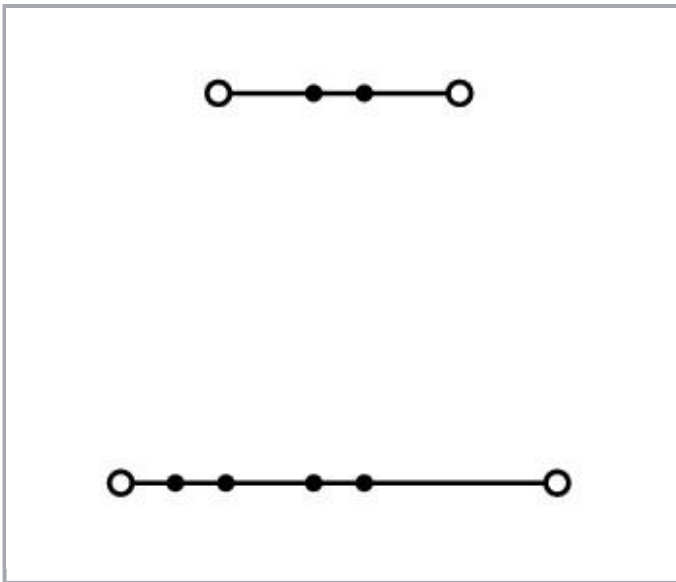

[www.wago.com/2002-2602](http://www.wago.com/2002-2602)

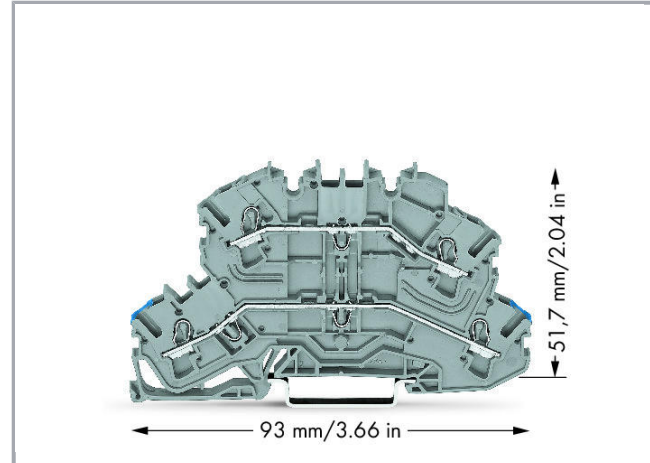
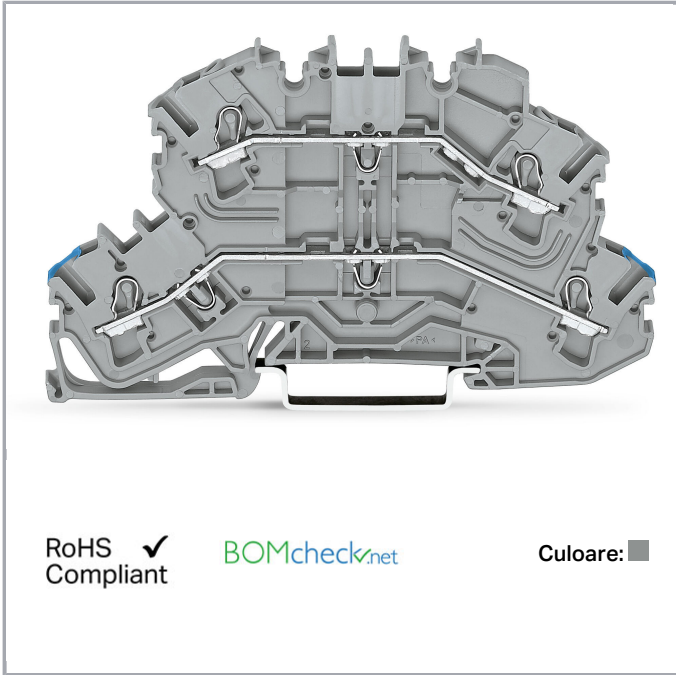

### Date

### Electrical data

Supus modificărilor.

WAGO Kontakttechnik GmbH & Co. KG  
/Representative Office Romania  
Sos. Pipera-Tunari nr. 1/1  
building 1, 2nd floor | 077190 Voluntari, Ilfov  
Tel.: +40-(0)31 421 85 68 | Email: info-RO@wago.com

Aveți întrebări despre produsele noastre?  
Vă stăm la dispoziție pentru preluarea apelului la +40 (0) 31 421 85 68.



### Ratings per IEC/EN 60664-1

Ratings per	IEC/EN 60947-7-1
Nominal voltage (III/3)	500 V
Rated surge voltage (III/3)	6 kV
Rated current	24 A
Legend (ratings)	(III / 3) $\hat{=}$ Overvoltage category III / Pollution degree 3

### Approvals per UL 1059

Rated voltage UL (Use Group B)	300 V
Rated current UL (Use Group B)	20 A
Rated voltage UL (Use Group C)	300 V
Rated current UL (Use Group C)	20 A
Approvals per	UL 1059

### Approvals per CSA

Rated voltage CSA (Use Group B)	300 V
Rated current CSA (Use Group B)	20 A
Rated voltage CSA (Use Group C)	300 V
Rated current CSA (Use Group C)	20 A

### Connection data

Connection technology	Push-in CAGE CLAMP <sup>®</sup>
Actuation type	Push-in Open Tool Slot
Connectable conductor materials	Copper
Nominal cross-section	2,5 mm <sup>2</sup>
Solid conductor	0,25 ... 4 mm <sup>2</sup> / 22 ... 12 AWG
Solid conductor; push-in termination	0,75 ... 4 mm <sup>2</sup> / 18 ... 12 AWG
Fine-stranded conductor	0,25 ... 4 mm <sup>2</sup> / 22 ... 12 AWG
Fine-stranded conductor; with insulated ferrule	1 ... 2,5 mm <sup>2</sup> / 18 ... 12 AWG
Fine-stranded conductor; with ferrule; push-in termination	1 ... 2,5 mm <sup>2</sup> / 18 ... 12 AWG
Strip length	10 ... 12 mm / 0.39 ... 0.47 inch
Total number of connection points	4
Total number of potentials	2
Number of levels	2
Wiring type	Front-entry wiring

Supus modificărilor.

WAGO Kontakttechnik GmbH & Co. KG  
/Representative Office Romania  
Sos. Pipera-Tunari nr. 1/1  
building 1, 2nd floor | 077190 Voluntari, Ilfov  
Tel.: +40-(0)31 421 85 68 | Email: info-RO@wago.com

Aveți întrebări despre produsele noastre?  
Vă stăm la dispoziție pentru preluarea apelului la +40 (0) 31 421 85 68.



Note (conductor cross-section)

Depending on the conductor characteristic, a conductor with a smaller cross-section can also be inserted via push-in termination.

## Geometrical Data

Width	5,2 mm / 0.205 inch
Height from upper-edge of DIN-rail	51,7 mm / 2.035 inch
Depth	93 mm / 3.661 inch

## Mechanical data

Design	horizontal type
Mounting type	DIN-35 rail
Potential marking	N/L
Marking level	Center/side marking

## Material Data

Color	gray
Insulation material	Polyamide 66 (PA 66)
Fire load	0,264 MJ
Weight	13,9g

## Commercial data

Product Group	22 (TOPJOB S)
Packaging type	BOX
Country of origin	DE
GTIN	4050821403814
Customs tariff number	85369010000

## Aprobări / certificate

### Country specific Approvals

Emblemă	Aprobare	Text de aprobare suplimentar	Nume certificat
	<b>CCA</b> DEKRA Certification B.V.	EN 60947	NTR NL 7730
	<b>CSA</b> DEKRA Certification B.V.	C22.2 No. 158	1536069

Supus modificărilor.

WAGO Kontakttechnik GmbH & Co. KG  
/Representative Office Romania  
Sos. Pipera-Tunari nr. 1/1  
building 1, 2nd floor | 077190 Voluntari, Ilfov  
Tel.: +40-(0)31 421 85 68 | Email: info-RO@wago.com

Aveți întrebări despre produsele noastre?  
Vă stăm la dispoziție pentru preluarea apelului la +40 (0) 31 421 85 68.





KEMA/KEUR  
DEKRA Certification B.V.

EN 60947

71-  
107687

### Ship Approvals

Emblemă	Aprobare	Text de aprobare suplimentar	Nume certificat
	<b>ABS</b> American Bureau of Shipping	EN 60947	20- HG1941090- PDA
	<b>DNV GL</b> Det Norske Veritas, Germanischer Lloyd	-	TAE00001V2

### UL-Approvals

Emblemă	Aprobare	Text de aprobare suplimentar	Nume certificat
	<b>UR</b> Underwriters Laboratories Inc.	UL 1059	E45172

### Counterpart















### Produse compatibile

### Carrier rail















Supus modificărilor.

WAGO Kontakttechnik GmbH & Co. KG  
/Representative Office Romania  
Sos. Pipera-Tunari nr. 1/1  
building 1, 2nd floor | 077190 Voluntari, Ilfov  
Tel.: +40-(0)31 421 85 68 | Email: info-RO@wago.com

Aveți întrebări despre produsele noastre?  
Vă stăm la dispoziție pentru preluarea apelului la +40 (0) 31 421 85 68.

	<b>Nr. articol: 210-112</b> Steel carrier rail; 35 x 7.5 mm; 1 mm thick; 2 m long; slotted; according to EN 60715; "Hole width 25 mm	<a href="http://www.wago.com/210-112">www.wago.com/210-112</a>
	<b>Nr. articol: 210-113</b> Steel carrier rail; 35 x 7.5 mm; 1 mm thick; 2 m long; unslotted; according to EN 60715	<a href="http://www.wago.com/210-113">www.wago.com/210-113</a>
	<b>Nr. articol: 210-114</b> Steel carrier rail; 35 x 15 mm; 1.5 mm thick; 2 m long; unslotted; similar to EN 60715	<a href="http://www.wago.com/210-114">www.wago.com/210-114</a>
	<b>Nr. articol: 210-115</b> Steel carrier rail; 35 x 7.5 mm; 1 mm thick; 2 m long; slotted; according to EN 60715; "Hole width 18 mm	<a href="http://www.wago.com/210-115">www.wago.com/210-115</a>
	<b>Nr. articol: 210-118</b> Steel carrier rail; 35 x 15 mm; 2.3 mm thick; 2 m long; unslotted; according to EN 60715	<a href="http://www.wago.com/210-118">www.wago.com/210-118</a>
	<b>Nr. articol: 210-196</b> Aluminum carrier rail; 35 x 8.2 mm; 1.6 mm thick; 2 m long; unslotted; similar to EN 60715; silver-colored	<a href="http://www.wago.com/210-196">www.wago.com/210-196</a>
	<b>Nr. articol: 210-197</b> Steel carrier rail; 35 x 15 mm; 1.5 mm thick; 2 m long; slotted; similar to EN 60715	<a href="http://www.wago.com/210-197">www.wago.com/210-197</a>
	<b>Nr. articol: 210-198</b> Copper carrier rail; 35 x 15 mm; 2.3 mm thick; 2 m long; unslotted; according to EN 60715; copper-colored	<a href="http://www.wago.com/210-198">www.wago.com/210-198</a>
	<b>Nr. articol: 210-504</b> Steel carrier rail; 35 x 7.5 mm; 1 mm thick; 2 m long; slotted; galvanized; according to EN 60715	<a href="http://www.wago.com/210-504">www.wago.com/210-504</a>
	<b>Nr. articol: 210-505</b> Steel carrier rail; 35 x 7.5 mm; 1 mm thick; 2 m long; unslotted; galvanized; according to EN 60715	<a href="http://www.wago.com/210-505">www.wago.com/210-505</a>
	<b>Nr. articol: 210-506</b> Steel carrier rail; 35 x 15 mm; 1.5 mm thick; 2 m long; unslotted; galvanized; similar to EN 60715	<a href="http://www.wago.com/210-506">www.wago.com/210-506</a>
	<b>Nr. articol: 210-508</b> Steel carrier rail; 35 x 15 mm; 1.5 mm thick; 2 m long; slotted; galvanized; similar to EN 60715	<a href="http://www.wago.com/210-508">www.wago.com/210-508</a>
<b>End plate</b>		
	<b>Nr. articol: 2002-2691</b> End and intermediate plate; 1 mm thick; gray	<a href="http://www.wago.com/2002-2691">www.wago.com/2002-2691</a>
	<b>Nr. articol: 2002-2692</b> End and intermediate plate; 1 mm thick; orange	<a href="http://www.wago.com/2002-2692">www.wago.com/2002-2692</a>
<b>Jumper</b>		
	<b>Nr. articol: 2002-400</b> Adjacent jumper for continuous commoning; insulated; 2-way; Nominal current 25 A; light gray	<a href="http://www.wago.com/2002-400">www.wago.com/2002-400</a>
	<b>Nr. articol: 2002-402</b> Push-in type jumper bar; insulated; 2-way; Nominal current 25 A; light gray	<a href="http://www.wago.com/2002-402">www.wago.com/2002-402</a>

Supus modificărilor.

	<b>Nr. articol:</b> 2002-402/000-005 Push-in type jumper bar; insulated; 2-way; Nominal current 25 A; red	<a href="http://www.wago.com/2002-402/000-005">www.wago.com/2002-402/000-005</a>
	<b>Nr. articol:</b> 2002-402/000-006 Push-in type jumper bar; insulated; 2-way; Nominal current 25 A; blue	<a href="http://www.wago.com/2002-402/000-006">www.wago.com/2002-402/000-006</a>
	<b>Nr. articol:</b> 2002-403 Push-in type jumper bar; insulated; 3-way; Nominal current 25 A; light gray	<a href="http://www.wago.com/2002-403">www.wago.com/2002-403</a>
	<b>Nr. articol:</b> 2002-403/000-005 Push-in type jumper bar; insulated; 3-way; Nominal current 25 A; red	<a href="http://www.wago.com/2002-403/000-005">www.wago.com/2002-403/000-005</a>
	<b>Nr. articol:</b> 2002-403/000-006 Push-in type jumper bar; insulated; 3-way; Nominal current 25 A; blue	<a href="http://www.wago.com/2002-403/000-006">www.wago.com/2002-403/000-006</a>
	<b>Nr. articol:</b> 2002-404 Push-in type jumper bar; insulated; 4-way; Nominal current 25 A; light gray	<a href="http://www.wago.com/2002-404">www.wago.com/2002-404</a>
	<b>Nr. articol:</b> 2002-404/000-005 Push-in type jumper bar; insulated; 4-way; Nominal current 25 A; red	<a href="http://www.wago.com/2002-404/000-005">www.wago.com/2002-404/000-005</a>
	<b>Nr. articol:</b> 2002-404/000-006 Push-in type jumper bar; insulated; 4-way; Nominal current 25 A; blue	<a href="http://www.wago.com/2002-404/000-006">www.wago.com/2002-404/000-006</a>
	<b>Nr. articol:</b> 2002-405 Push-in type jumper bar; insulated; 5-way; Nominal current 25 A; light gray	<a href="http://www.wago.com/2002-405">www.wago.com/2002-405</a>
	<b>Nr. articol:</b> 2002-405/000-005 Push-in type jumper bar; insulated; 5-way; Nominal current 25 A; red	<a href="http://www.wago.com/2002-405/000-005">www.wago.com/2002-405/000-005</a>
	<b>Nr. articol:</b> 2002-405/000-006 Push-in type jumper bar; insulated; 5-way; Nominal current 25 A; blue	<a href="http://www.wago.com/2002-405/000-006">www.wago.com/2002-405/000-006</a>
	<b>Nr. articol:</b> 2002-405/011-000 Star point jumper; insulated; 3-way (1-3-5); IN = IN terminal block; light gray	<a href="http://www.wago.com/2002-405/011-000">www.wago.com/2002-405/011-000</a>
	<b>Nr. articol:</b> 2002-406 Push-in type jumper bar; insulated; 6-way; Nominal current 25 A; light gray	<a href="http://www.wago.com/2002-406">www.wago.com/2002-406</a>
	<b>Nr. articol:</b> 2002-406/000-005 Push-in type jumper bar; insulated; 6-way; Nominal current 25 A; red	<a href="http://www.wago.com/2002-406/000-005">www.wago.com/2002-406/000-005</a>

Supus modificărilor.

WAGO Kontakttechnik GmbH & Co. KG  
/Representative Office Romania  
Sos. Pipera-Tunari nr. 1/1  
building 1, 2nd floor | 077190 Voluntari, Ilfov  
Tel.: +40-(0)31 421 85 68 | Email: info-RO@wago.com

Aveți întrebări despre produsele noastre?  
Vă stăm la dispoziție pentru preluarea apelului la +40 (0) 31 421 85 68.



**Nr. articol: 2002-406/000-006**  
Push-in type jumper bar; insulated; 6-way; Nominal current 25 A; blue

[www.wago.com/2002-406/000-006](http://www.wago.com/2002-406/000-006)



**Nr. articol: 2002-406/020-000**  
Delta jumper; insulated; 1-2 3-4 5-6; IN = IN terminal block; light gray

[www.wago.com/2002-406/020-000](http://www.wago.com/2002-406/020-000)



**Nr. articol: 2002-407**  
Push-in type jumper bar; insulated; 7-way; Nominal current 25 A; light gray

[www.wago.com/2002-407](http://www.wago.com/2002-407)



**Nr. articol: 2002-407/000-005**  
Push-in type jumper bar; insulated; 7-way; Nominal current 25 A; red

[www.wago.com/2002-407/000-005](http://www.wago.com/2002-407/000-005)



**Nr. articol: 2002-407/000-006**  
Push-in type jumper bar; insulated; 7-way; Nominal current 25 A; blue

[www.wago.com/2002-407/000-006](http://www.wago.com/2002-407/000-006)



**Nr. articol: 2002-408**  
Push-in type jumper bar; insulated; 8-way; Nominal current 25 A; light gray

[www.wago.com/2002-408](http://www.wago.com/2002-408)



**Nr. articol: 2002-408/000-005**  
Push-in type jumper bar; insulated; 8-way; Nominal current 25 A; red

[www.wago.com/2002-408/000-005](http://www.wago.com/2002-408/000-005)



**Nr. articol: 2002-408/000-006**  
Push-in type jumper bar; insulated; 8-way; Nominal current 25 A; blue

[www.wago.com/2002-408/000-006](http://www.wago.com/2002-408/000-006)



**Nr. articol: 2002-409**  
Push-in type jumper bar; insulated; 9-way; Nominal current 25 A; light gray

[www.wago.com/2002-409](http://www.wago.com/2002-409)



**Nr. articol: 2002-409/000-005**  
Push-in type jumper bar; insulated; 9-way; Nominal current 25 A; red

[www.wago.com/2002-409/000-005](http://www.wago.com/2002-409/000-005)



**Nr. articol: 2002-409/000-006**  
Push-in type jumper bar; insulated; 9-way; Nominal current 25 A; blue

[www.wago.com/2002-409/000-006](http://www.wago.com/2002-409/000-006)



**Nr. articol: 2002-410**  
Push-in type jumper bar; insulated; 10-way; Nominal current 25 A; light gray

[www.wago.com/2002-410](http://www.wago.com/2002-410)



**Nr. articol: 2002-410/000-005**  
Push-in type jumper bar; insulated; 10-way; Nominal current 25 A; red

[www.wago.com/2002-410/000-005](http://www.wago.com/2002-410/000-005)

















**Nr. articol: 2002-410/000-006**  
Push-in type jumper bar; insulated; 10-way; Nominal current 25 A; blue

[www.wago.com/2002-410/000-006](http://www.wago.com/2002-410/000-006)

Supus modificărilor.













WAGO Kontakttechnik GmbH & Co. KG  
/Representative Office Romania  
Sos. Pipera-Tunari nr. 1/1  
building 1, 2nd floor | 077190 Voluntari, Ilfov  
Tel.: +40-(0)31 421 85 68 | Email: info-RO@wago.com

Aveți întrebări despre produsele noastre?  
Vă stăm la dispoziție pentru preluarea apelului la +40 (0) 31 421 85 68.

	<b>Nr. articol: 2002-423</b> Adjacent jumper for continuous commoning; insulated; from 1 to 3; Nominal current 25 A; light gray	<a href="http://www.wago.com/2002-423">www.wago.com/2002-423</a>
	<b>Nr. articol: 2002-423/000-005</b> Adjacent jumper for continuous commoning; insulated; from 1 to 3; Nominal current 25 A; red	<a href="http://www.wago.com/2002-423/000-005">www.wago.com/2002-423/000-005</a>
	<b>Nr. articol: 2002-423/000-006</b> Adjacent jumper for continuous commoning; insulated; from 1 to 3; Nominal current 25 A; blue	<a href="http://www.wago.com/2002-423/000-006">www.wago.com/2002-423/000-006</a>
	<b>Nr. articol: 2002-433</b> Push-in type jumper bar; insulated; from 1 to 3; Nominal current 25 A; light gray	<a href="http://www.wago.com/2002-433">www.wago.com/2002-433</a>
	<b>Nr. articol: 2002-434</b> Push-in type jumper bar; insulated; from 1 to 4; Nominal current 25 A; light gray	<a href="http://www.wago.com/2002-434">www.wago.com/2002-434</a>
	<b>Nr. articol: 2002-435</b> Push-in type jumper bar; insulated; from 1 to 5; Nominal current 25 A; light gray	<a href="http://www.wago.com/2002-435">www.wago.com/2002-435</a>
	<b>Nr. articol: 2002-436</b> Push-in type jumper bar; insulated; from 1 to 6; Nominal current 25 A; light gray	<a href="http://www.wago.com/2002-436">www.wago.com/2002-436</a>
	<b>Nr. articol: 2002-437</b> Push-in type jumper bar; insulated; from 1 to 7; Nominal current 25 A; light gray	<a href="http://www.wago.com/2002-437">www.wago.com/2002-437</a>
	<b>Nr. articol: 2002-438</b> Push-in type jumper bar; insulated; from 1 to 8; Nominal current 25 A; light gray	<a href="http://www.wago.com/2002-438">www.wago.com/2002-438</a>
	<b>Nr. articol: 2002-439</b> Push-in type jumper bar; insulated; from 1 to 9; Nominal current 25 A; light gray	<a href="http://www.wago.com/2002-439">www.wago.com/2002-439</a>
	<b>Nr. articol: 2002-440</b> Push-in type jumper bar; insulated; from 1 to 10; Nominal current 25 A; light gray	<a href="http://www.wago.com/2002-440">www.wago.com/2002-440</a>
	<b>Nr. articol: 2002-472</b> Staggered jumper; insulated; 2-way; Nominal current 25 A; suitable for 2002 and 2003 Series rail-mounted terminal blocks; light gray	<a href="http://www.wago.com/2002-472">www.wago.com/2002-472</a>
	<b>Nr. articol: 2002-473</b> Staggered jumper; insulated; 3-way; Nominal current 25 A; suitable for 2002 and 2003 Series rail-mounted terminal blocks; light gray	<a href="http://www.wago.com/2002-473">www.wago.com/2002-473</a>
	<b>Nr. articol: 2002-473/011-000</b> Ready-made staggered jumper; insulated; 2-way (1-3); Nominal current 25 A; with contact lugs broken off at the factory and circuit marking; light gray	<a href="http://www.wago.com/2002-473/011-000">www.wago.com/2002-473/011-000</a>
	<b>Nr. articol: 2002-474</b> Staggered jumper; insulated; 4-way; Nominal current 25 A; suitable for 2002 and 2003 Series rail-mounted terminal blocks; light gray	<a href="http://www.wago.com/2002-474">www.wago.com/2002-474</a>
	<b>Nr. articol: 2002-475</b> Staggered jumper; insulated; 5-way; Nominal current 25 A; suitable for 2002 and 2003 Series rail-mounted terminal blocks; light gray	<a href="http://www.wago.com/2002-475">www.wago.com/2002-475</a>

Supus modificărilor.

















	<b>Nr. articol: 2002-475/011-000</b> Ready-made staggered jumper; insulated; 3-way (1-3-5); Nominal current 25 A; with contact lugs broken off at the factory and circuit marking; light gray	<a href="http://www.wago.com/2002-475/011-000">www.wago.com/2002-475/011-000</a>
	<b>Nr. articol: 2002-476</b> Staggered jumper; insulated; 6-way; Nominal current 25 A; suitable for 2002 and 2003 Series rail-mounted terminal blocks; light gray	<a href="http://www.wago.com/2002-476">www.wago.com/2002-476</a>
	<b>Nr. articol: 2002-477</b> Staggered jumper; insulated; 7-way; Nominal current 25 A; suitable for 2002 and 2003 Series rail-mounted terminal blocks; light gray	<a href="http://www.wago.com/2002-477">www.wago.com/2002-477</a>
	<b>Nr. articol: 2002-477/011-000</b> Ready-made staggered jumper; insulated; 1-3-5-7; Nominal current 25 A; with contact lugs broken off at the factory and circuit marking; light gray	<a href="http://www.wago.com/2002-477/011-000">www.wago.com/2002-477/011-000</a>
	<b>Nr. articol: 2002-478</b> Staggered jumper; insulated; 8-way; Nominal current 25 A; suitable for 2002 and 2003 Series rail-mounted terminal blocks; light gray	<a href="http://www.wago.com/2002-478">www.wago.com/2002-478</a>
	<b>Nr. articol: 2002-479</b> Staggered jumper; insulated; 9-way; Nominal current 25 A; suitable for 2002 and 2003 Series rail-mounted terminal blocks; light gray	<a href="http://www.wago.com/2002-479">www.wago.com/2002-479</a>
	<b>Nr. articol: 2002-479/011-000</b> Ready-made staggered jumper; insulated; 1-3-5-7-9; Nominal current 25 A; with contact lugs broken off at the factory and circuit marking; light gray	<a href="http://www.wago.com/2002-479/011-000">www.wago.com/2002-479/011-000</a>
	<b>Nr. articol: 2002-480</b> Staggered jumper; insulated; 10-way; Nominal current 25 A; suitable for 2002 and 2003 Series rail-mounted terminal blocks; light gray	<a href="http://www.wago.com/2002-480">www.wago.com/2002-480</a>
	<b>Nr. articol: 2002-481</b> Staggered jumper; insulated; 11-way; Nominal current 25 A; suitable for 2002 and 2003 Series rail-mounted terminal blocks; light gray	<a href="http://www.wago.com/2002-481">www.wago.com/2002-481</a>
	<b>Nr. articol: 2002-481/011-000</b> Ready-made staggered jumper; insulated; 1-3-5-7-9-11; Nominal current 25 A; with contact lugs broken off at the factory and circuit marking; light gray	<a href="http://www.wago.com/2002-481/011-000">www.wago.com/2002-481/011-000</a>
	<b>Nr. articol: 2002-482</b> Staggered jumper; insulated; 12-way; Nominal current 25 A; suitable for 2002 and 2003 Series rail-mounted terminal blocks; light gray	<a href="http://www.wago.com/2002-482">www.wago.com/2002-482</a>
	<b>Nr. articol: 2002-492</b> Double-deck vertical jumper; insulated; light gray	<a href="http://www.wago.com/2002-492">www.wago.com/2002-492</a>
	<b>Nr. articol: 2002-492/000-012</b> Double-deck vertical jumper; insulated; orange	<a href="http://www.wago.com/2002-492/000-012">www.wago.com/2002-492/000-012</a>
	<b>Nr. articol: 210-103</b> Wire commoning chain; insulated; 50 connections; black	<a href="http://www.wago.com/210-103">www.wago.com/210-103</a>
	<b>Nr. articol: 210-123</b> Wire commoning chain; insulated; 50 connections	<a href="http://www.wago.com/210-123">www.wago.com/210-123</a>

## ferrule





Supus modificărilor.

WAGO Kontakttechnik GmbH & Co. KG  
/Representative Office Romania  
Sos. Pipera-Tunari nr. 1/1  
building 1, 2nd floor | 077190 Voluntari, Ilfov  
Tel.: +40-(0)31 421 85 68 | Email: info-RO@wago.com





Aveți întrebări despre produsele noastre?  
Vă stăm la dispoziție pentru preluarea apelului la +40 (0) 31 421 85 68.

	<b>Nr. articol: 216-241</b> Ferrule; Sleeve for 0.5 mm <sup>2</sup> / 20 AWG; insulated; electro-tin plated; electrolytic copper; gastight crimped; acc. to DIN 46228, Part 4/09.90; white	<a href="http://www.wago.com/216-241">www.wago.com/216-241</a>
	<b>Nr. articol: 216-242</b> Ferrule; Sleeve for 0.75 mm <sup>2</sup> / 18 AWG; insulated; electro-tin plated; electrolytic copper; gastight crimped; acc. to DIN 46228, Part 4/09.90; gray	<a href="http://www.wago.com/216-242">www.wago.com/216-242</a>
	<b>Nr. articol: 216-243</b> Ferrule; Sleeve for 1 mm <sup>2</sup> / AWG 18; insulated; electro-tin plated; electrolytic copper; gastight crimped; acc. to DIN 46228, Part 4/09.90; red	<a href="http://www.wago.com/216-243">www.wago.com/216-243</a>
	<b>Nr. articol: 216-244</b> Ferrule; Sleeve for 1.5 mm <sup>2</sup> / AWG 16; insulated; electro-tin plated; electrolytic copper; gastight crimped; acc. to DIN 46228, Part 4/09.90; black	<a href="http://www.wago.com/216-244">www.wago.com/216-244</a>
	<b>Nr. articol: 216-246</b> Ferrule; Sleeve for 2.5 mm <sup>2</sup> / AWG 14; insulated; electro-tin plated; electrolytic copper; gastight crimped; acc. to DIN 46228, Part 4/09.90; blue	<a href="http://www.wago.com/216-246">www.wago.com/216-246</a>
	<b>Nr. articol: 216-262</b> Ferrule; Sleeve for 0.75 mm <sup>2</sup> / 18 AWG; insulated; electro-tin plated; electrolytic copper; gastight crimped; acc. to DIN 46228, Part 4/09.90; gray	<a href="http://www.wago.com/216-262">www.wago.com/216-262</a>
	<b>Nr. articol: 216-263</b> Ferrule; Sleeve for 1 mm <sup>2</sup> / AWG 18; insulated; electro-tin plated; electrolytic copper; gastight crimped; acc. to DIN 46228, Part 4/09.90; red	<a href="http://www.wago.com/216-263">www.wago.com/216-263</a>
	<b>Nr. articol: 216-264</b> Ferrule; Sleeve for 1.5 mm <sup>2</sup> / AWG 16; insulated; electro-tin plated; electrolytic copper; gastight crimped; acc. to DIN 46228, Part 4/09.90; black	<a href="http://www.wago.com/216-264">www.wago.com/216-264</a>
	<b>Nr. articol: 216-266</b> Ferrule; Sleeve for 2.5 mm <sup>2</sup> / AWG 14; insulated; electro-tin plated; electrolytic copper; gastight crimped; acc. to DIN 46228, Part 4/09.90; blue	<a href="http://www.wago.com/216-266">www.wago.com/216-266</a>
<b>Protective Warning Marker</b>		
	<b>Nr. articol: 2002-115</b> Protective warning marker; with high-voltage symbol, black; for 5 terminal blocks; yellow	<a href="http://www.wago.com/2002-115">www.wago.com/2002-115</a>
<b>Insulation stop</b>		
	<b>Nr. articol: 2002-171</b> Insulation stop; 0.25 - 0.5 mm <sup>2</sup> ; 5 pieces/strip; light gray	<a href="http://www.wago.com/2002-171">www.wago.com/2002-171</a>
	<b>Nr. articol: 2002-172</b> Insulation stop; 0.75 - 1 mm <sup>2</sup> ; 5 pieces/strip; dark gray	<a href="http://www.wago.com/2002-172">www.wago.com/2002-172</a>
<b>tools</b>		
	<b>Nr. articol: 210-658</b> Operating tool; Blade: 3.5 x 0.5 mm; with a partially insulated shaft; angled; short	<a href="http://www.wago.com/210-658">www.wago.com/210-658</a>
	<b>Nr. articol: 210-720</b> Operating tool; Blade: 3.5 x 0.5 mm; with a partially insulated shaft	<a href="http://www.wago.com/210-720">www.wago.com/210-720</a>
<b>Push-In type wire jumper</b>		
	<b>Nr. articol: 2009-412</b> Push-in type wire jumper; insulated; wire length 60 mm; Conductor cross section 1.5 mm <sup>2</sup> ; suitable for 2001, 2002, 2003 and 2022 Series rail-mounted terminal blocks; black	<a href="http://www.wago.com/2009-412">www.wago.com/2009-412</a>







Supus modificărilor.

	<b>Nr. articol: 2009-414</b> Push-in type wire jumper; insulated; wire length 110 mm; Conductor cross section 1.5 mm <sup>2</sup> ; suitable for 2001, 2002, 2003 and 2022 Series rail-mounted terminal blocks; black	<a href="http://www.wago.com/2009-414">www.wago.com/2009-414</a>
	<b>Nr. articol: 2009-414/000-005</b> Push-in type wire jumper; insulated; wire length 110 mm; Conductor cross section 1.5 mm <sup>2</sup> ; suitable for 2001, 2002, 2003 and 2022 Series rail-mounted terminal blocks; red	<a href="http://www.wago.com/2009-414/000-005">www.wago.com/2009-414/000-005</a>
	<b>Nr. articol: 2009-414/000-006</b> Push-in type wire jumper; insulated; wire length 110 mm; Conductor cross section 1.5 mm <sup>2</sup> ; suitable for 2001, 2002, 2003 and 2022 Series rail-mounted terminal blocks; blue	<a href="http://www.wago.com/2009-414/000-006">www.wago.com/2009-414/000-006</a>
	<b>Nr. articol: 2009-416</b> Push-in type wire jumper; insulated; wire length 250 mm; Conductor cross section 1.5 mm <sup>2</sup> ; suitable for 2001, 2002, 2003 and 2022 Series rail-mounted terminal blocks; black	<a href="http://www.wago.com/2009-416">www.wago.com/2009-416</a>

## check

	<b>Nr. articol: 2002-611</b> TOPJOB®S L-type test plug module; modular; 1-pole; 2,50 mm <sup>2</sup> ; gray	<a href="http://www.wago.com/2002-611">www.wago.com/2002-611</a>
	<b>Nr. articol: 2002-649</b> TOPJOB®S L-type spacer module; modular; e.g., for bridging commoned terminal blocks; gray	<a href="http://www.wago.com/2002-649">www.wago.com/2002-649</a>
	<b>Nr. articol: 2009-174</b> Test plug adapter; for 4 mm Ø test plugs; for testing TOPJOB®S rail-mounted terminal blocks; gray	<a href="http://www.wago.com/2009-174">www.wago.com/2009-174</a>
	<b>Nr. articol: 2009-182</b> Testing tap; for max. 2.5 mm <sup>2</sup> ; tool-free connection for individual test wires 0.08 - 2.5 mm; gray	<a href="http://www.wago.com/2009-182">www.wago.com/2009-182</a>















## Marking accessories

	<b>Nr. articol: 2002-121</b> Adaptor	<a href="http://www.wago.com/2002-121">www.wago.com/2002-121</a>
	<b>Nr. articol: 2002-161</b> Adaptor	<a href="http://www.wago.com/2002-161">www.wago.com/2002-161</a>
	<b>Nr. articol: 2009-110</b> Marking strips; on reel; not stretchable; plain; snap-on type; white	<a href="http://www.wago.com/2009-110">www.wago.com/2009-110</a>
	<b>Nr. articol: 2009-115</b> WMB-Inline; for Smart Printer; 1500 pieces on roll; stretchable 5 - 5.2 mm; plain; snap-on type; white	<a href="http://www.wago.com/2009-115">www.wago.com/2009-115</a>
	<b>Nr. articol: 2009-115/000-002</b> WMB-Inline; for Smart Printer; 1500 pieces on roll; stretchable 5 - 5.2 mm; plain; snap-on type; yellow	<a href="http://www.wago.com/2009-115/000-002">www.wago.com/2009-115/000-002</a>
	<b>Nr. articol: 2009-115/000-005</b> WMB-Inline; for Smart Printer; 1500 pieces on roll; stretchable 5 - 5.2 mm; plain; snap-on type; red	<a href="http://www.wago.com/2009-115/000-005">www.wago.com/2009-115/000-005</a>
	<b>Nr. articol: 2009-115/000-006</b> WMB-Inline; for Smart Printer; 1500 pieces on roll; stretchable 5 - 5.2 mm; plain; snap-on type; blue	<a href="http://www.wago.com/2009-115/000-006">www.wago.com/2009-115/000-006</a>















Supus modificărilor.

WAGO Kontakttechnik GmbH & Co. KG  
/Representative Office Romania  
Sos. Pipera-Tunari nr. 1/1  
building 1, 2nd floor | 077190 Voluntari, Ilfov  
Tel.: +40-(0)31 421 85 68 | Email: info-RO@wago.com

Aveți întrebări despre produsele noastre?  
Vă stăm la dispoziție pentru preluarea apelului la +40 (0) 31 421 85 68.

	<b>Nr. articol: 2009-115/000-007</b> WMB-Inline; for Smart Printer; 1500 pieces on roll; stretchable 5 - 5.2 mm; plain; snap-on type; gray	<a href="http://www.wago.com/2009-115/000-007">www.wago.com/2009-115/000-007</a>
	<b>Nr. articol: 2009-115/000-012</b> WMB-Inline; for Smart Printer; 1500 pieces on roll; stretchable 5 - 5.2 mm; plain; snap-on type; orange	<a href="http://www.wago.com/2009-115/000-012">www.wago.com/2009-115/000-012</a>
	<b>Nr. articol: 2009-115/000-017</b> WMB-Inline; for Smart Printer; 1500 pieces on roll; stretchable 5 - 5.2 mm; plain; snap-on type; light green	<a href="http://www.wago.com/2009-115/000-017">www.wago.com/2009-115/000-017</a>
	<b>Nr. articol: 2009-115/000-023</b> WMB-Inline; for Smart Printer; 1500 pieces on roll; stretchable 5 - 5.2 mm; plain; snap-on type; green	<a href="http://www.wago.com/2009-115/000-023">www.wago.com/2009-115/000-023</a>
	<b>Nr. articol: 2009-115/000-024</b> WMB-Inline; for Smart Printer; 1500 pieces on roll; stretchable 5 - 5.2 mm; plain; snap-on type; violet	<a href="http://www.wago.com/2009-115/000-024">www.wago.com/2009-115/000-024</a>
	<b>Nr. articol: 2009-145</b> Mini-WSB Inline; for Smart Printer; 1700 pieces on roll; stretchable 5 - 5.2 mm; plain; snap-on type; white	<a href="http://www.wago.com/2009-145">www.wago.com/2009-145</a>
	<b>Nr. articol: 2009-145/000-002</b> Mini-WSB Inline; for Smart Printer; 1700 pieces on roll; stretchable 5 - 5.2 mm; plain; snap-on type; yellow	<a href="http://www.wago.com/2009-145/000-002">www.wago.com/2009-145/000-002</a>
	<b>Nr. articol: 2009-145/000-005</b> Mini-WSB Inline; for Smart Printer; 1700 pieces on roll; stretchable 5 - 5.2 mm; plain; snap-on type; red	<a href="http://www.wago.com/2009-145/000-005">www.wago.com/2009-145/000-005</a>
	<b>Nr. articol: 2009-145/000-006</b> Mini-WSB Inline; for Smart Printer; 1700 pieces on roll; stretchable 5 - 5.2 mm; plain; snap-on type; blue	<a href="http://www.wago.com/2009-145/000-006">www.wago.com/2009-145/000-006</a>
	<b>Nr. articol: 2009-145/000-007</b> Mini-WSB Inline; for Smart Printer; 1700 pieces on roll; stretchable 5 - 5.2 mm; plain; snap-on type; gray	<a href="http://www.wago.com/2009-145/000-007">www.wago.com/2009-145/000-007</a>
	<b>Nr. articol: 2009-145/000-012</b> Mini-WSB Inline; for Smart Printer; 1700 pieces on roll; stretchable 5 - 5.2 mm; plain; snap-on type; orange	<a href="http://www.wago.com/2009-145/000-012">www.wago.com/2009-145/000-012</a>
	<b>Nr. articol: 2009-145/000-023</b> Mini-WSB Inline; for Smart Printer; 1700 pieces on roll; stretchable 5 - 5.2 mm; plain; snap-on type; green	<a href="http://www.wago.com/2009-145/000-023">www.wago.com/2009-145/000-023</a>
	<b>Nr. articol: 2009-145/000-024</b> Mini-WSB Inline; for Smart Printer; 1700 pieces on roll; stretchable 5 - 5.2 mm; plain; snap-on type; violet	<a href="http://www.wago.com/2009-145/000-024">www.wago.com/2009-145/000-024</a>
	<b>Nr. articol: 2009-191</b> Group marker carrier	<a href="http://www.wago.com/2009-191">www.wago.com/2009-191</a>

Supus modificărilor.

	<b>Nr. articol: 2009-192</b> Group marker carrier	<a href="http://www.wago.com/2009-192">www.wago.com/2009-192</a>
	<b>Nr. articol: 2009-193</b> Group marker carrier	<a href="http://www.wago.com/2009-193">www.wago.com/2009-193</a>
	<b>Nr. articol: 2009-198</b> Adaptor	<a href="http://www.wago.com/2009-198">www.wago.com/2009-198</a>
	<b>Nr. articol: 248-501</b> Miniature WSB Quick marking system; plain; Marker width 5 mm; 10 strips with 10 markers per card	<a href="http://www.wago.com/248-501">www.wago.com/248-501</a>
	<b>Nr. articol: 248-501/000-002</b> Mini-WSB marking card; as card; not stretchable; plain; snap-on type; yellow	<a href="http://www.wago.com/248-501/000-002">www.wago.com/248-501/000-002</a>
	<b>Nr. articol: 248-501/000-005</b> Mini-WSB marking card; as card; not stretchable; plain; snap-on type; red	<a href="http://www.wago.com/248-501/000-005">www.wago.com/248-501/000-005</a>
	<b>Nr. articol: 248-501/000-006</b> Mini-WSB marking card; as card; not stretchable; plain; snap-on type; blue	<a href="http://www.wago.com/248-501/000-006">www.wago.com/248-501/000-006</a>
	<b>Nr. articol: 248-501/000-007</b> Mini-WSB marking card; as card; not stretchable; plain; snap-on type; gray	<a href="http://www.wago.com/248-501/000-007">www.wago.com/248-501/000-007</a>
	<b>Nr. articol: 248-501/000-012</b> Mini-WSB marking card; as card; not stretchable; plain; snap-on type; orange	<a href="http://www.wago.com/248-501/000-012">www.wago.com/248-501/000-012</a>
	<b>Nr. articol: 248-501/000-017</b> Mini-WSB marking card; as card; not stretchable; plain; snap-on type; light green	<a href="http://www.wago.com/248-501/000-017">www.wago.com/248-501/000-017</a>
	<b>Nr. articol: 248-501/000-023</b> Mini-WSB marking card; as card; not stretchable; plain; snap-on type; green	<a href="http://www.wago.com/248-501/000-023">www.wago.com/248-501/000-023</a>
	<b>Nr. articol: 248-501/000-024</b> Mini-WSB marking card; as card; not stretchable; plain; snap-on type; violet	<a href="http://www.wago.com/248-501/000-024">www.wago.com/248-501/000-024</a>
	<b>Nr. articol: 793-501</b> WMB marking card; as card; not stretchable; plain; snap-on type; white	<a href="http://www.wago.com/793-501">www.wago.com/793-501</a>
	<b>Nr. articol: 793-501/000-002</b> WMB marking card; as card; not stretchable; plain; snap-on type; yellow	<a href="http://www.wago.com/793-501/000-002">www.wago.com/793-501/000-002</a>
	<b>Nr. articol: 793-501/000-005</b> WMB marking card; as card; not stretchable; plain; snap-on type; red	<a href="http://www.wago.com/793-501/000-005">www.wago.com/793-501/000-005</a>

Supus modificărilor.



**Nr. articol: 793-501/000-006**  
WMB marking card; as card; not stretchable; plain; snap-on type; blue

[www.wago.com/793-501/000-006](http://www.wago.com/793-501/000-006)



**Nr. articol: 793-501/000-007**  
WMB marking card; as card; not stretchable; plain; snap-on type; gray

[www.wago.com/793-501/000-007](http://www.wago.com/793-501/000-007)



**Nr. articol: 793-501/000-012**  
WMB marking card; as card; not stretchable; plain; snap-on type; orange

[www.wago.com/793-501/000-012](http://www.wago.com/793-501/000-012)



**Nr. articol: 793-501/000-017**  
WMB marking card; as card; not stretchable; plain; snap-on type; light green

[www.wago.com/793-501/000-017](http://www.wago.com/793-501/000-017)



**Nr. articol: 793-501/000-023**  
WMB marking card; as card; not stretchable; plain; snap-on type; green

[www.wago.com/793-501/000-023](http://www.wago.com/793-501/000-023)



**Nr. articol: 793-501/000-024**  
WMB marking card; as card; not stretchable; plain; snap-on type; violet

[www.wago.com/793-501/000-024](http://www.wago.com/793-501/000-024)



**Nr. articol: 793-5501**  
WMB marking card; as card; for terminal block width 5 - 17.5 mm; stretchable 5 - 5.2 mm; plain; snap-on type; white

[www.wago.com/793-5501](http://www.wago.com/793-5501)



**Nr. articol: 793-5501/000-002**  
WMB marking card; as card; for terminal block width 5 - 17.5 mm; stretchable 5 - 5.2 mm; plain; snap-on type; yellow

[www.wago.com/793-5501/000-002](http://www.wago.com/793-5501/000-002)



**Nr. articol: 793-5501/000-005**  
WMB marking card; as card; for terminal block width 5 - 17.5 mm; stretchable 5 - 5.2 mm; plain; snap-on type; red

[www.wago.com/793-5501/000-005](http://www.wago.com/793-5501/000-005)



**Nr. articol: 793-5501/000-006**  
WMB marking card; as card; for terminal block width 5 - 17.5 mm; stretchable 5 - 5.2 mm; plain; snap-on type; blue

[www.wago.com/793-5501/000-006](http://www.wago.com/793-5501/000-006)



**Nr. articol: 793-5501/000-007**  
WMB marking card; as card; for terminal block width 5 - 17.5 mm; stretchable 5 - 5.2 mm; plain; snap-on type; gray

[www.wago.com/793-5501/000-007](http://www.wago.com/793-5501/000-007)



**Nr. articol: 793-5501/000-012**  
WMB marking card; as card; for terminal block width 5 - 17.5 mm; stretchable 5 - 5.2 mm; plain; snap-on type; orange

[www.wago.com/793-5501/000-012](http://www.wago.com/793-5501/000-012)



**Nr. articol: 793-5501/000-014**  
WMB marking card; as card; for terminal block width 5 - 17.5 mm; stretchable 5 - 5.2 mm; plain; snap-on type; brown

[www.wago.com/793-5501/000-014](http://www.wago.com/793-5501/000-014)

**Nr. articol: 793-5501/000-017**

Supus modificărilor.



WMB marking card; as card; for terminal block width 5 - 17.5 mm; stretchable 5 - 5.2 mm; plain; snap-on type; green

[www.wago.com/793-5501/000-017](http://www.wago.com/793-5501/000-017)



**Nr. articol: 793-5501/000-023**

WMB marking card; as card; for terminal block width 5 - 17.5 mm; stretchable 5 - 5.2 mm; plain; snap-on type; light green

[www.wago.com/793-5501/000-023](http://www.wago.com/793-5501/000-023)



**Nr. articol: 793-5501/000-024**

WMB marking card; as card; for terminal block width 5 - 17.5 mm; stretchable 5 - 5.2 mm; plain; snap-on type; violet

[www.wago.com/793-5501/000-024](http://www.wago.com/793-5501/000-024)

## Descărcări

### Documentation

#### Additional Information

Technical explanations	Apr 3, 2019	pdf 2,1 MB	Descărcare
------------------------	-------------	---------------	------------

## CAD/CAE-Data

### CAD data

2D/3D Models 2002-2602	URL	Descărcare
------------------------	-----	------------

### CAE data

EPLAN Data Portal 2002-2602	URL	Descărcare
-----------------------------	-----	------------

WSCAD Universe 2002-2602	URL	Descărcare
--------------------------	-----	------------

## Installation Notes

### Conductor termination

Supus modificărilor.

WAGO Kontakttechnik GmbH & Co. KG  
/Representative Office Romania  
Sos. Pipera-Tunari nr. 1/1  
building 1, 2nd floor | 077190 Voluntari, Ilfov  
Tel.: +40-(0)31 421 85 68 | Email: [info-RO@wago.com](mailto:info-RO@wago.com)

Aveți întrebări despre produsele noastre?  
Vă stăm la dispoziție pentru preluarea apelului la +40 (0) 31 421 85 68.



All conductor types at a glance



Terminating solid and ferruled conductors via push-in connection.



Inserting conductors via push-in termination.

**Solid conductors** with cross-sections from either one size above, or up to two sizes below, the rated cross-section can be simply pushed in – no tools needed.

Supus modificărilor.





Inserting a conductor via operating tool.



Conductor termination – Insulation stop.

Connecting fine-stranded conductors without ferrules, or small cross-sectional conductors that cannot be pushed in, is performed similarly to the original CAGE CLAMP® – just use an operating tool.

#### The smart feature:

To open the clamp, the operating tool is inserted vertically. The conductor entry is less than 15 degrees for easier wiring.

#### Commoning

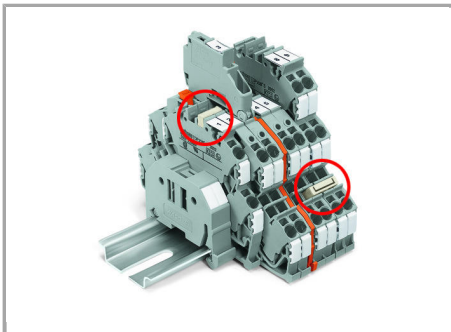

The same profile allows for commoning with TOPJOB® S double-deck terminal blocks (upper deck) and with triple-deck terminal blocks (lower deck).

Supus modificărilor.

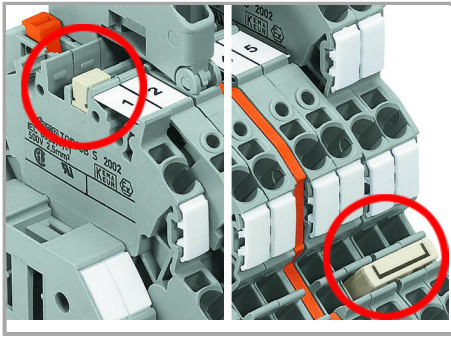

Left picture – Vertical jumper (2002-492)

Right picture – Push-in type jumper bar  
(2002 Series)

## Familie de produse

### TOPJOB® S

TOPJOB® S: In various industrial applications and modern building installations, WAGO's wide and versatile range of rail-mount terminal blocks provides more than just reliable electrical connections.

[Afișare globală produse din familie.](#)

Supus modificărilor.