

## Fișă tehnică | Număr articol: 870-590/281-410

Component terminal block; triple-deck; with diode 1N4007; anode, left side;  
for DIN-rail 35 x 15 and 35 x 7.5; 2.5 mm<sup>2</sup>; CAGE CLAMP®; 2,50 mm<sup>2</sup>; gray

[www.wago.com/870-590/281-410](http://www.wago.com/870-590/281-410)

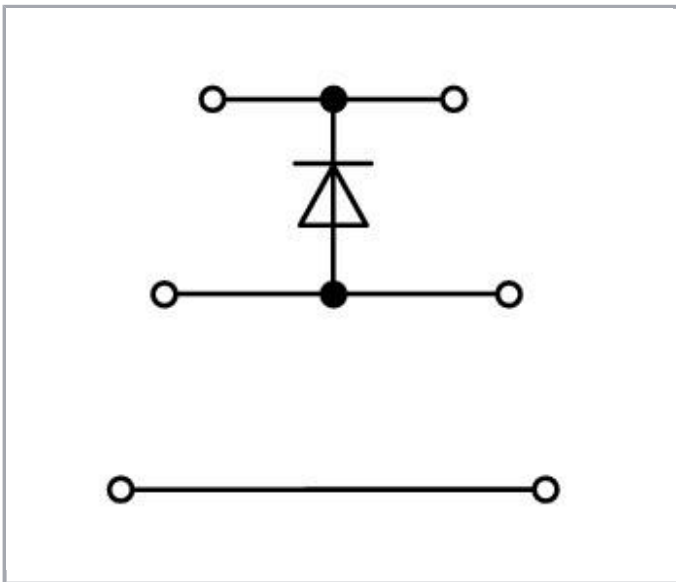
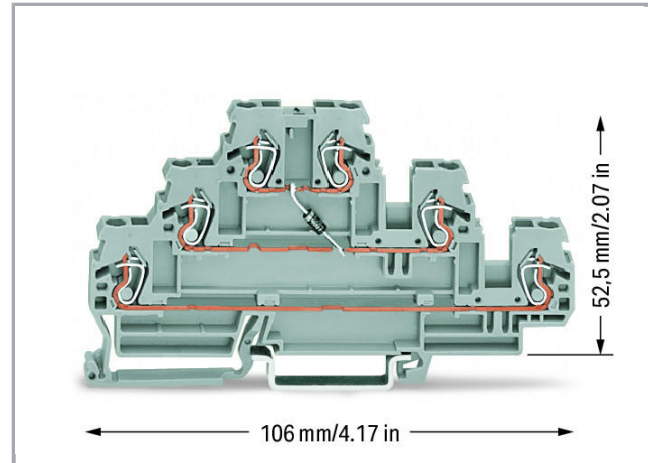
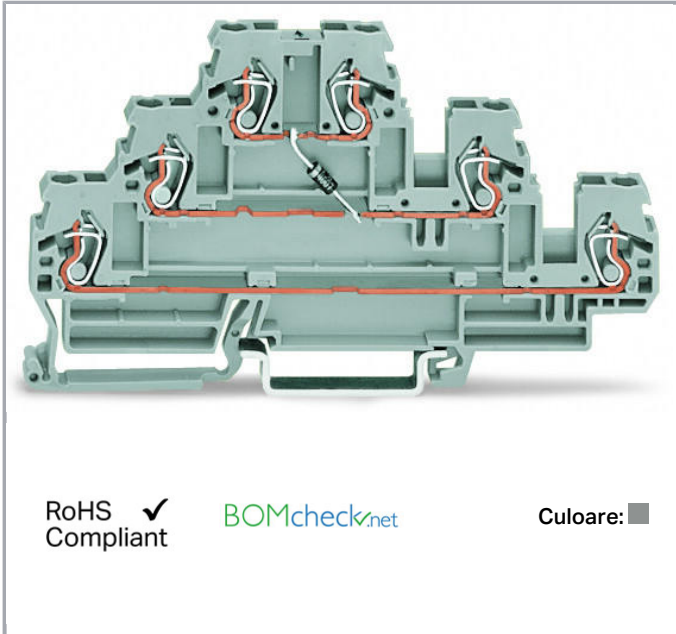

### Descriere articol

#### Safety information 1:

Max. insulation diameter: 4.4 mm

Supus modificărilor.

WAGO Kontakttechnik GmbH & Co. KG  
/Representative Office Romania  
Sos. Pipera-Tunari nr. 1/1  
building 1, 2nd floor | 077190 Voluntari, Ilfov  
Tel.: +40-(0)31 421 85 68 | Email: info-RO@wago.com

Aveți întrebări despre produsele noastre?

Vă stăm la dispoziție pentru preluarea apelului la +40 (0) 31 421 85 68.

**Date****Electrical data**

Nominal voltage	250 V
Reverse voltage	1.000 V

**Ratings per IEC/EN 60664-1**

Ratings per	IEC/EN 60947-7-1
Rated current	0,5 A

**Connection data**

Connection technology	CAGE CLAMP®
Actuation type	Operating tool
Connectable conductor materials	Copper
Solid conductor	0.08 ... 2.5 mm <sup>2</sup> / 28 ... 12 AWG
Fine-stranded conductor	0.08 ... 4 mm <sup>2</sup> / 28 ... 12 AWG
Strip length	6 ... 7 mm / 0.24 ... 0.28 inch
Total number of connection points	6
Total number of potentials	2
Number of levels	3
Wiring type	Front-entry wiring

**Geometrical Data**

Width	5 mm / 0.197 inch
Height from upper-edge of DIN-rail	52.5 mm / 2.067 inch
Depth	106 mm / 4.173 inch

**Mechanical data**

Design	horizontal
Mounting type	DIN-35 rail
Marking level	Side marking

**Material Data**

Color	gray
Insulation material	Polyamide 66 (PA 66)

Supus modificărilor.

WAGO Kontakttechnik GmbH & Co. KG  
 /Representative Office Romania  
 Sos. Pipera-Tunari nr. 1/1  
 building 1, 2nd floor | 077190 Voluntari, Ilfov  
 Tel.: +40-(0)31 421 85 68 | Email: info-RO@wago.com

Aveți întrebări despre produsele noastre?  
 Vă stăm la dispoziție pentru preluarea apelului la +40 (0) 31 421 85 68.

Fire load	0,275 MJ
Weight	17,2 g









### Commercial data

Product Group	16 (Rail Mounted Terminal Block with CCC)
Packaging type	BOX
Country of origin	DE
GTIN	4045454198749
Customs tariff number	85369010000















### Counterpart

### Produse compatibile

#### ferrule

	<b>Nr. articol: 216-121</b> Ferrule; Sleeve for 0.5 mm <sup>2</sup> / AWG 22; uninsulated; electro-tin plated	<a href="http://www.wago.com/216-121">www.wago.com/216-121</a>
	<b>Nr. articol: 216-122</b> Ferrule; Sleeve for 0.75 mm <sup>2</sup> / AWG 20; uninsulated; electro-tin plated	<a href="http://www.wago.com/216-122">www.wago.com/216-122</a>
	<b>Nr. articol: 216-123</b> Ferrule; Sleeve for 1 mm <sup>2</sup> / AWG 18; uninsulated; electro-tin plated	<a href="http://www.wago.com/216-123">www.wago.com/216-123</a>
	<b>Nr. articol: 216-124</b> Ferrule; Sleeve for 1.5 mm <sup>2</sup> / AWG 16; uninsulated; electro-tin plated	<a href="http://www.wago.com/216-124">www.wago.com/216-124</a>
	<b>Nr. articol: 216-131</b> Ferrule; Sleeve for 0.25 mm <sup>2</sup> / AWG 24; uninsulated; electro-tin plated	<a href="http://www.wago.com/216-131">www.wago.com/216-131</a>
	<b>Nr. articol: 216-132</b> Ferrule; Sleeve for 0.34 mm <sup>2</sup> / AWG 24; uninsulated; electro-tin plated	<a href="http://www.wago.com/216-132">www.wago.com/216-132</a>
	<b>Nr. articol: 216-221</b> Ferrule; Sleeve for 0.5 mm <sup>2</sup> / 20 AWG; insulated; electro-tin plated; white	<a href="http://www.wago.com/216-221">www.wago.com/216-221</a>
	<b>Nr. articol: 216-222</b> Ferrule; Sleeve for 0.75 mm <sup>2</sup> / 18 AWG; insulated; electro-tin plated; gray	<a href="http://www.wago.com/216-222">www.wago.com/216-222</a>

Supus modificărilor.

	<b>Nr. articol: 216-223</b> Ferrule; Sleeve for 1 mm <sup>2</sup> / AWG 18; insulated; electro-tin plated; red	<a href="http://www.wago.com/216-223">www.wago.com/216-223</a>
	<b>Nr. articol: 216-224</b> Ferrule; Sleeve for 1.5 mm <sup>2</sup> / AWG 16; insulated; electro-tin plated; black	<a href="http://www.wago.com/216-224">www.wago.com/216-224</a>
	<b>Nr. articol: 216-321</b> Ferrule; Sleeve for 0.25 mm <sup>2</sup> / AWG 24; insulated; electro-tin plated; yellow	<a href="http://www.wago.com/216-321">www.wago.com/216-321</a>
	<b>Nr. articol: 216-322</b> Ferrule; Sleeve for 0.34 mm <sup>2</sup> / 22 AWG; insulated; electro-tin plated; green	<a href="http://www.wago.com/216-322">www.wago.com/216-322</a>
<b>tools</b>		
	<b>Nr. articol: 210-657</b> Operating tool; Blade: 3.5 x 0.5 mm; with a partially insulated shaft; short	<a href="http://www.wago.com/210-657">www.wago.com/210-657</a>
	<b>Nr. articol: 210-658</b> Operating tool; Blade: 3.5 x 0.5 mm; with a partially insulated shaft; angled; short	<a href="http://www.wago.com/210-658">www.wago.com/210-658</a>
	<b>Nr. articol: 210-720</b> Operating tool; Blade: 3.5 x 0.5 mm; with a partially insulated shaft	<a href="http://www.wago.com/210-720">www.wago.com/210-720</a>
<b>Carrier rail</b>		
	<b>Nr. articol: 210-112</b> Steel carrier rail; 35 x 7.5 mm; 1 mm thick; 2 m long; slotted; according to EN 60715; "Hole width 25 mm	<a href="http://www.wago.com/210-112">www.wago.com/210-112</a>
	<b>Nr. articol: 210-113</b> Steel carrier rail; 35 x 7.5 mm; 1 mm thick; 2 m long; unslotted; according to EN 60715	<a href="http://www.wago.com/210-113">www.wago.com/210-113</a>
	<b>Nr. articol: 210-114</b> Steel carrier rail; 35 x 15 mm; 1.5 mm thick; 2 m long; unslotted; similar to EN 60715	<a href="http://www.wago.com/210-114">www.wago.com/210-114</a>
	<b>Nr. articol: 210-115</b> Steel carrier rail; 35 x 7.5 mm; 1 mm thick; 2 m long; slotted; according to EN 60715; "Hole width 18 mm	<a href="http://www.wago.com/210-115">www.wago.com/210-115</a>
	<b>Nr. articol: 210-118</b> Steel carrier rail; 35 x 15 mm; 2.3 mm thick; 2 m long; unslotted; according to EN 60715	<a href="http://www.wago.com/210-118">www.wago.com/210-118</a>
	<b>Nr. articol: 210-196</b> Aluminum carrier rail; 35 x 8.2 mm; 1.6 mm thick; 2 m long; unslotted; similar to EN 60715; silver-colored	<a href="http://www.wago.com/210-196">www.wago.com/210-196</a>
	<b>Nr. articol: 210-197</b> Steel carrier rail; 35 x 15 mm; 1.5 mm thick; 2 m long; slotted; similar to EN 60715	<a href="http://www.wago.com/210-197">www.wago.com/210-197</a>
	<b>Nr. articol: 210-198</b> Copper carrier rail; 35 x 15 mm; 2.3 mm thick; 2 m long; unslotted; according to EN 60715; copper-colored	<a href="http://www.wago.com/210-198">www.wago.com/210-198</a>
	<b>Nr. articol: 210-504</b> Steel carrier rail; 35 x 7.5 mm; 1 mm thick; 2 m long; slotted; galvanized; according to EN 60715	<a href="http://www.wago.com/210-504">www.wago.com/210-504</a>
	<b>Nr. articol: 210-505</b> Steel carrier rail; 35 x 7.5 mm; 1 mm thick; 2 m long; unslotted; galvanized; according to EN 60715	<a href="http://www.wago.com/210-505">www.wago.com/210-505</a>

Supus modificărilor.

WAGO Kontakttechnik GmbH & Co. KG  
/Representative Office Romania  
Sos. Pipera-Tunari nr. 1/1  
building 1, 2nd floor | 077190 Voluntari, Ilfov  
Tel.: +40-(0)31 421 85 68 | Email: info-RO@wago.com

Aveți întrebări despre produsele noastre?  
Vă stăm la dispoziție pentru preluarea apelului la +40 (0) 31 421 85 68.

**Nr. articol: 210-506**

Steel carrier rail; 35 x 15 mm; 1.5 mm thick; 2 m long; unslotted; galvanized; similar to EN 60715

[www.wago.com/210-506](http://www.wago.com/210-506)**Nr. articol: 210-508**

Steel carrier rail; 35 x 15 mm; 1.5 mm thick; 2 m long; slotted; galvanized; similar to EN 60715

[www.wago.com/210-508](http://www.wago.com/210-508)**Marking accessories****Nr. articol: 2009-115**

WMB-Inline; for Smart Printer; 1500 pieces on roll; stretchable 5 - 5.2 mm; plain; snap-on type; white

[www.wago.com/2009-115](http://www.wago.com/2009-115)**Nr. articol: 2009-115/000-002**

WMB-Inline; for Smart Printer; 1500 pieces on roll; stretchable 5 - 5.2 mm; plain; snap-on type; yellow

[www.wago.com/2009-115/000-002](http://www.wago.com/2009-115/000-002)**Nr. articol: 2009-115/000-006**

WMB-Inline; for Smart Printer; 1500 pieces on roll; stretchable 5 - 5.2 mm; plain; snap-on type; blue

[www.wago.com/2009-115/000-006](http://www.wago.com/2009-115/000-006)**Nr. articol: 2009-115/000-007**

WMB-Inline; for Smart Printer; 1500 pieces on roll; stretchable 5 - 5.2 mm; plain; snap-on type; gray

[www.wago.com/2009-115/000-007](http://www.wago.com/2009-115/000-007)**Nr. articol: 2009-115/000-012**

WMB-Inline; for Smart Printer; 1500 pieces on roll; stretchable 5 - 5.2 mm; plain; snap-on type; orange

[www.wago.com/2009-115/000-012](http://www.wago.com/2009-115/000-012)**Nr. articol: 2009-115/000-017**

WMB-Inline; for Smart Printer; 1500 pieces on roll; stretchable 5 - 5.2 mm; plain; snap-on type; light green

[www.wago.com/2009-115/000-017](http://www.wago.com/2009-115/000-017)**Nr. articol: 2009-115/000-023**

WMB-Inline; for Smart Printer; 1500 pieces on roll; stretchable 5 - 5.2 mm; plain; snap-on type; green

[www.wago.com/2009-115/000-023](http://www.wago.com/2009-115/000-023)**Nr. articol: 2009-115/000-024**

WMB-Inline; for Smart Printer; 1500 pieces on roll; stretchable 5 - 5.2 mm; plain; snap-on type; violet

[www.wago.com/2009-115/000-024](http://www.wago.com/2009-115/000-024)**Nr. articol: 2009-145**

Mini-WSB Inline; for Smart Printer; 1700 pieces on roll; stretchable 5 - 5.2 mm; plain; snap-on type; white

[www.wago.com/2009-145](http://www.wago.com/2009-145)**Nr. articol: 2009-145/000-002**

Mini-WSB Inline; for Smart Printer; 1700 pieces on roll; stretchable 5 - 5.2 mm; plain; snap-on type; yellow

[www.wago.com/2009-145/000-002](http://www.wago.com/2009-145/000-002)**Nr. articol: 2009-145/000-005**

Mini-WSB Inline; for Smart Printer; 1700 pieces on roll; stretchable 5 - 5.2 mm; plain; snap-on type; red

[www.wago.com/2009-145/000-005](http://www.wago.com/2009-145/000-005)**Nr. articol: 2009-145/000-006**















Mini-WSB Inline; for Smart Printer; 1700 pieces on roll; stretchable 5 - 5.2 mm; plain; snap-on type; blue

[www.wago.com/2009-145/000-006](http://www.wago.com/2009-145/000-006)

Supus modificărilor.

WAGO Kontakttechnik GmbH & Co. KG  
/Representative Office Romania  
Sos. Pipera-Tunari nr. 1/1  
building 1, 2nd floor | 077190 Voluntari, Ilfov  
Tel.: +40-(0)31 421 85 68 | Email: info-RO@wago.com















Aveți întrebări despre produsele noastre?  
Vă stăm la dispoziție pentru preluarea apelului la +40 (0) 31 421 85 68.

	<b>Nr. articol: 2009-145/000-007</b> Mini-WSB Inline; for Smart Printer; 1700 pieces on roll; stretchable 5 - 5.2 mm; plain; snap-on type; gray	<a href="http://www.wago.com/2009-145/000-007">www.wago.com/2009-145/000-007</a>
	<b>Nr. articol: 2009-145/000-012</b> Mini-WSB Inline; for Smart Printer; 1700 pieces on roll; stretchable 5 - 5.2 mm; plain; snap-on type; orange	<a href="http://www.wago.com/2009-145/000-012">www.wago.com/2009-145/000-012</a>
	<b>Nr. articol: 2009-145/000-023</b> Mini-WSB Inline; for Smart Printer; 1700 pieces on roll; stretchable 5 - 5.2 mm; plain; snap-on type; green	<a href="http://www.wago.com/2009-145/000-023">www.wago.com/2009-145/000-023</a>
	<b>Nr. articol: 2009-145/000-024</b> Mini-WSB Inline; for Smart Printer; 1700 pieces on roll; stretchable 5 - 5.2 mm; plain; snap-on type; violet	<a href="http://www.wago.com/2009-145/000-024">www.wago.com/2009-145/000-024</a>
	<b>Nr. articol: 248-501</b> Miniature WSB Quick marking system; plain; Marker width 5 mm; 10 strips with 10 markers per card	<a href="http://www.wago.com/248-501">www.wago.com/248-501</a>
	<b>Nr. articol: 248-501/000-002</b> Mini-WSB marking card; as card; not stretchable; plain; snap-on type; yellow	<a href="http://www.wago.com/248-501/000-002">www.wago.com/248-501/000-002</a>
	<b>Nr. articol: 248-501/000-005</b> Mini-WSB marking card; as card; not stretchable; plain; snap-on type; red	<a href="http://www.wago.com/248-501/000-005">www.wago.com/248-501/000-005</a>
	<b>Nr. articol: 248-501/000-006</b> Mini-WSB marking card; as card; not stretchable; plain; snap-on type; blue	<a href="http://www.wago.com/248-501/000-006">www.wago.com/248-501/000-006</a>
	<b>Nr. articol: 248-501/000-007</b> Mini-WSB marking card; as card; not stretchable; plain; snap-on type; gray	<a href="http://www.wago.com/248-501/000-007">www.wago.com/248-501/000-007</a>
	<b>Nr. articol: 248-501/000-012</b> Mini-WSB marking card; as card; not stretchable; plain; snap-on type; orange	<a href="http://www.wago.com/248-501/000-012">www.wago.com/248-501/000-012</a>
	<b>Nr. articol: 248-501/000-017</b> Mini-WSB marking card; as card; not stretchable; plain; snap-on type; light green	<a href="http://www.wago.com/248-501/000-017">www.wago.com/248-501/000-017</a>
	<b>Nr. articol: 248-501/000-023</b> Mini-WSB marking card; as card; not stretchable; plain; snap-on type; green	<a href="http://www.wago.com/248-501/000-023">www.wago.com/248-501/000-023</a>
	<b>Nr. articol: 248-501/000-024</b> Mini-WSB marking card; as card; not stretchable; plain; snap-on type; violet	<a href="http://www.wago.com/248-501/000-024">www.wago.com/248-501/000-024</a>
	<b>Nr. articol: 709-177</b> Marking strips; on reel; 7.5 mm wide; not stretchable; plain; snap-on type; translucent	<a href="http://www.wago.com/709-177">www.wago.com/709-177</a>

Supus modificărilor.

WAGO Kontakttechnik GmbH & Co. KG  
/Representative Office Romania  
Sos. Pipera-Tunari nr. 1/1  
building 1, 2nd floor | 077190 Voluntari, Ilfov  
Tel.: +40-(0)31 421 85 68 | Email: info-RO@wago.com

Aveți întrebări despre produsele noastre?  
Vă stăm la dispoziție pentru preluarea apelului la +40 (0) 31 421 85 68.

	<b>Nr. articol: 709-178</b> Marking strips; on reel; 7.5 mm wide; not stretchable; plain; snap-on type; white	<a href="http://www.wago.com/709-178">www.wago.com/709-178</a>
	<b>Nr. articol: 709-196</b> Marking strips; for laser printer; translucent	<a href="http://www.wago.com/709-196">www.wago.com/709-196</a>
	<b>Nr. articol: 709-198</b> Marking strips; white	<a href="http://www.wago.com/709-198">www.wago.com/709-198</a>
	<b>Nr. articol: 793-501</b> WMB marking card; as card; not stretchable; plain; snap-on type; white	<a href="http://www.wago.com/793-501">www.wago.com/793-501</a>
	<b>Nr. articol: 793-501/000-002</b> WMB marking card; as card; not stretchable; plain; snap-on type; yellow	<a href="http://www.wago.com/793-501/000-002">www.wago.com/793-501/000-002</a>
	<b>Nr. articol: 793-501/000-005</b> WMB marking card; as card; not stretchable; plain; snap-on type; red	<a href="http://www.wago.com/793-501/000-005">www.wago.com/793-501/000-005</a>
	<b>Nr. articol: 793-501/000-006</b> WMB marking card; as card; not stretchable; plain; snap-on type; blue	<a href="http://www.wago.com/793-501/000-006">www.wago.com/793-501/000-006</a>
	<b>Nr. articol: 793-501/000-007</b> WMB marking card; as card; not stretchable; plain; snap-on type; gray	<a href="http://www.wago.com/793-501/000-007">www.wago.com/793-501/000-007</a>
	<b>Nr. articol: 793-501/000-012</b> WMB marking card; as card; not stretchable; plain; snap-on type; orange	<a href="http://www.wago.com/793-501/000-012">www.wago.com/793-501/000-012</a>
	<b>Nr. articol: 793-501/000-017</b> WMB marking card; as card; not stretchable; plain; snap-on type; light green	<a href="http://www.wago.com/793-501/000-017">www.wago.com/793-501/000-017</a>
	<b>Nr. articol: 793-501/000-023</b> WMB marking card; as card; not stretchable; plain; snap-on type; green	<a href="http://www.wago.com/793-501/000-023">www.wago.com/793-501/000-023</a>
	<b>Nr. articol: 793-501/000-024</b> WMB marking card; as card; not stretchable; plain; snap-on type; violet	<a href="http://www.wago.com/793-501/000-024">www.wago.com/793-501/000-024</a>
	<b>Nr. articol: 793-5501</b> WMB marking card; as card; for terminal block width 5 - 17.5 mm; stretchable 5 - 5.2 mm; plain; snap-on type; white	<a href="http://www.wago.com/793-5501">www.wago.com/793-5501</a>
	<b>Nr. articol: 793-5501/000-002</b> WMB marking card; as card; for terminal block width 5 - 17.5 mm; stretchable 5 - 5.2 mm; plain; snap-on type; yellow	<a href="http://www.wago.com/793-5501/000-002">www.wago.com/793-5501/000-002</a>
	<b>Nr. articol: 793-5501/000-005</b> WMB marking card; as card; for terminal block width 5 - 17.5 mm; stretchable 5 - 5.2 mm; plain; snap-on	

Supus modificărilor.



type; red

[www.wago.com/793-5501/000-005](http://www.wago.com/793-5501/000-005)**Nr. articol: 793-5501/000-006**

WMB marking card; as card; for terminal block width 5 - 17.5 mm; stretchable 5 - 5.2 mm; plain; snap-on type; blue

[www.wago.com/793-5501/000-006](http://www.wago.com/793-5501/000-006)**Nr. articol: 793-5501/000-007**

WMB marking card; as card; for terminal block width 5 - 17.5 mm; stretchable 5 - 5.2 mm; plain; snap-on type; gray

[www.wago.com/793-5501/000-007](http://www.wago.com/793-5501/000-007)**Nr. articol: 793-5501/000-012**

WMB marking card; as card; for terminal block width 5 - 17.5 mm; stretchable 5 - 5.2 mm; plain; snap-on type; orange

[www.wago.com/793-5501/000-012](http://www.wago.com/793-5501/000-012)**Nr. articol: 793-5501/000-017**

WMB marking card; as card; for terminal block width 5 - 17.5 mm; stretchable 5 - 5.2 mm; plain; snap-on type; green

[www.wago.com/793-5501/000-017](http://www.wago.com/793-5501/000-017)**Nr. articol: 793-5501/000-023**

WMB marking card; as card; for terminal block width 5 - 17.5 mm; stretchable 5 - 5.2 mm; plain; snap-on type; light green

[www.wago.com/793-5501/000-023](http://www.wago.com/793-5501/000-023)**Nr. articol: 793-5501/000-024**

WMB marking card; as card; for terminal block width 5 - 17.5 mm; stretchable 5 - 5.2 mm; plain; snap-on type; violet

[www.wago.com/793-5501/000-024](http://www.wago.com/793-5501/000-024)**Insulation stop****Nr. articol: 280-470**Insulation stop; 0.08 - 0.2 mm<sup>2</sup> "s" (0.14 mm<sup>2</sup> "f-st"); 5 pieces/strip; white[www.wago.com/280-470](http://www.wago.com/280-470)**Nr. articol: 280-471**Insulation stop; 0.25 - 0.5 mm<sup>2</sup>; 5 pieces/strip; light gray[www.wago.com/280-471](http://www.wago.com/280-471)**Nr. articol: 280-472**Insulation stop; 0.75 - 1 mm<sup>2</sup>; 5 pieces/strip[www.wago.com/280-472](http://www.wago.com/280-472)**End plate****Nr. articol: 870-568**

End and intermediate plate; 2 mm thick; gray

[www.wago.com/870-568](http://www.wago.com/870-568)**Nr. articol: 870-569**

End and intermediate plate; 2 mm thick; orange

[www.wago.com/870-569](http://www.wago.com/870-569)**Jumper****Nr. articol: 870-402**

Push-in type jumper bar; insulated; 2-way; Nominal current 18 A; light gray

[www.wago.com/870-402](http://www.wago.com/870-402)**Nr. articol: 870-403**

Push-in type jumper bar; insulated; 3-way; Nominal current 18 A; light gray

[www.wago.com/870-403](http://www.wago.com/870-403)

Supus modificărilor.



	<b>Nr. articol: 870-404</b> Push-in type jumper bar; insulated; 4-way; Nominal current 18 A; light gray	<a href="http://www.wago.com/870-404">www.wago.com/870-404</a>
	<b>Nr. articol: 870-405</b> Push-in type jumper bar; insulated; 5-way; Nominal current 18 A; light gray	<a href="http://www.wago.com/870-405">www.wago.com/870-405</a>
	<b>Nr. articol: 870-405/011-000</b> Ready-made push-in type jumper bar; insulated; 3-way (1-3-5); Nominal current 18 A; light gray	<a href="http://www.wago.com/870-405/011-000">www.wago.com/870-405/011-000</a>
	<b>Nr. articol: 870-406</b> Push-in type jumper bar; insulated; 6-way; Nominal current 18 A; light gray	<a href="http://www.wago.com/870-406">www.wago.com/870-406</a>
	<b>Nr. articol: 870-407</b> Push-in type jumper bar; insulated; 7-way; Nominal current 18 A; light gray	<a href="http://www.wago.com/870-407">www.wago.com/870-407</a>
	<b>Nr. articol: 870-407/011-000</b> Ready-made push-in type jumper bar; insulated; 1-3-5-7; Nominal current 18 A; light gray	<a href="http://www.wago.com/870-407/011-000">www.wago.com/870-407/011-000</a>
	<b>Nr. articol: 870-408</b> Push-in type jumper bar; insulated; 8-way; Nominal current 18 A; light gray	<a href="http://www.wago.com/870-408">www.wago.com/870-408</a>
	<b>Nr. articol: 870-409</b> Push-in type jumper bar; insulated; 9-way; Nominal current 18 A; light gray	<a href="http://www.wago.com/870-409">www.wago.com/870-409</a>
	<b>Nr. articol: 870-409/011-000</b> Ready-made push-in type jumper bar; insulated; 1-3-5-7-9; Nominal current 18 A; light gray	<a href="http://www.wago.com/870-409/011-000">www.wago.com/870-409/011-000</a>
	<b>Nr. articol: 870-410</b> Push-in type jumper bar; insulated; 10-way; Nominal current 18 A; light gray	<a href="http://www.wago.com/870-410">www.wago.com/870-410</a>
	<b>Nr. articol: 870-433</b> Push-in type jumper bar; insulated; from 1 to 3; Nominal current 18 A; light gray	<a href="http://www.wago.com/870-433">www.wago.com/870-433</a>
	<b>Nr. articol: 870-434</b> Push-in type jumper bar; insulated; from 1 to 4; Nominal current 18 A; light gray	<a href="http://www.wago.com/870-434">www.wago.com/870-434</a>
	<b>Nr. articol: 870-435</b> Push-in type jumper bar; insulated; from 1 to 5; Nominal current 18 A; light gray	<a href="http://www.wago.com/870-435">www.wago.com/870-435</a>
	<b>Nr. articol: 870-436</b> Push-in type jumper bar; insulated; from 1 to 6; Nominal current 18 A; light gray	<a href="http://www.wago.com/870-436">www.wago.com/870-436</a>
	<b>Nr. articol: 870-437</b> Push-in type jumper bar; insulated; from 1 to 7; Nominal current 18 A; light gray	<a href="http://www.wago.com/870-437">www.wago.com/870-437</a>
	<b>Nr. articol: 870-438</b> Push-in type jumper bar; insulated; from 1 to 8; Nominal current 18 A; light gray	<a href="http://www.wago.com/870-438">www.wago.com/870-438</a>
	<b>Nr. articol: 870-439</b> Push-in type jumper bar; insulated; from 1 to 9; Nominal current 18 A; light gray	<a href="http://www.wago.com/870-439">www.wago.com/870-439</a>

Supus modificărilor.



Nr. articol: 870-440

Push-in type jumper bar; insulated; from 1 to 10; Nominal current 18 A; light gray

[www.wago.com/870-440](http://www.wago.com/870-440)

---

**Protective Warning Marker**

Nr. articol: 280-405

Protective warning marker; with high-voltage symbol, black; for 5 terminal blocks; yellow

[www.wago.com/280-405](http://www.wago.com/280-405)

---

**assembling**

Nr. articol: 209-106

Mounting carrier; for isolated mounting on DIN 35 rails; gray

[www.wago.com/209-106](http://www.wago.com/209-106)

Nr. articol: 249-116

Screwless end stop; 6 mm wide; for DIN-rail 35 x 15 and 35 x 7.5; gray

[www.wago.com/249-116](http://www.wago.com/249-116)

Nr. articol: 249-117

Screwless end stop; 10 mm wide; for DIN-rail 35 x 15 and 35 x 7.5; gray

[www.wago.com/249-117](http://www.wago.com/249-117)

---

**Descărcări**
**Documentation****Additional Information**

Technical explanations

Apr 3, 2019

pdf  
2,1 MB

Descărcare

---

**CAD/CAE-Data**
**CAD data**

2D/3D Models 870-590/281-410

URL

Descărcare

**CAE data**

EPLAN Data Portal 870-590/281-410

URL

Descărcare

WSCAD Universe 870-590/281-410

URL

Descărcare

---

**Installation Notes**

Supus modificărilor.

WAGO Kontakttechnik GmbH & Co. KG  
/Representative Office Romania  
Sos. Pipera-Tunari nr. 1/1  
building 1, 2nd floor | 077190 Voluntari, Ilfov  
Tel.: +40-(0)31 421 85 68 | Email: info-RO@wago.com

Aveți întrebări despre produsele noastre?  
Vă stăm la dispoziție pentru preluarea apelului la +40 (0) 31 421 85 68.