

## Fișă tehnică | Număr articol: 280-649

4-conductor disconnect/test terminal block; without pivoting knife disconnect; with touch-proof test sockets; Test socket, red; for DIN-rail 35 x 15 and 35 x 7.5; 2.5 mm<sup>2</sup>; CAGE CLAMP®; 2,50 mm<sup>2</sup>; gray

[www.wago.com/280-649](http://www.wago.com/280-649)

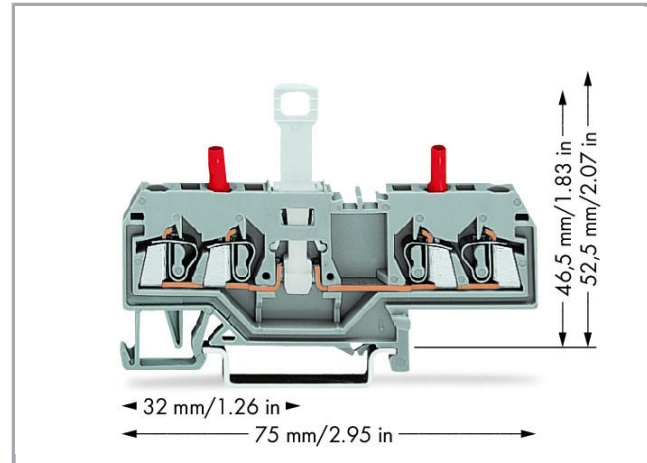
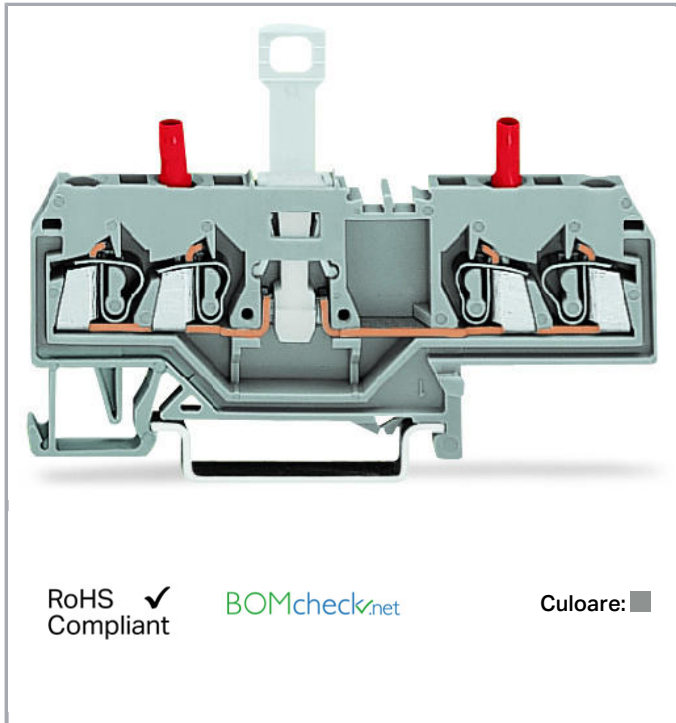

RoHS  Compliant

[BOMcheck.net](https://www.bomcheck.net)

Culoare: ■

### Descriere articol

#### Note:

##### Terminating Aluminum Conductors

WAGO spring clamp terminal blocks are suitable for solid aluminum conductors up to 4 mm<sup>2</sup>/12 AWG if WAGO "Alu-Plus" Contact Paste is used for termination.

##### "Alu-Plus" Contact Paste Advantages:

- Automatically destroys the oxide film during clamping.
- Prevents fresh oxidation at the clamping point.
- Prevents electrolytic corrosion between aluminum and copper conductors (in the same terminal block).
- Provides long-term protection against corrosion.

Using terminal blocks with CAGE CLAMP® Spring Pressure Connection Technology, **aluminum conductors must first be cleaned with a blade and then immediately be inserted into the clamping units filled with "Alu-Plus" Contact Paste.**

Supus modificărilor.

WAGO Kontakttechnik GmbH & Co. KG  
/Representative Office Romania  
Sos. Pipera-Tunari nr. 1/1  
building 1, 2nd floor | 077190 Voluntari, Ilfov  
Tel.: +40-(0)31 421 85 68 | Email: [info-RO@wago.com](mailto:info-RO@wago.com)

Aveți întrebări despre produsele noastre?  
Vă stăm la dispoziție pentru preluarea apelului la +40 (0) 31 421 85 68.



It is also possible to apply WAGO "Alu-Plus" **additionally** on the whole surface of the aluminum conductor before termination.

Please note that the nominal currents must be adapted to the reduced conductivity of the aluminum conductors::

2.5 mm<sup>2</sup> = 16 A

4 mm<sup>2</sup> = 22 A

## Date

### Electrical data

#### Ratings per IEC/EN 60664-1

Nominal voltage (III/3)	400 V
Rated surge voltage (III/3)	6 kV
Rated current	10 A
Legend (ratings)	(III / 3) ≙ Overvoltage category III / Pollution degree 3

### Connection data

Connection technology	CAGE CLAMP®
Actuation type	Operating tool
Connectable conductor materials	Copper Aluminum
Solid conductor	0,08 ... 2,5 mm <sup>2</sup> / 28 ... 12 AWG
Fine-stranded conductor	0,08 ... 2,5 mm <sup>2</sup> / 28 ... 12 AWG
Strip length	8 ... 9 mm / 0.31 ... 0.35 inch
Total number of connection points	2
Total number of potentials	2
Number of levels	1
Wiring type	Front-entry wiring
Note (conductor cross-section)	12 AWG: THHN, THWN

### Geometrical Data

Width	5 mm / 0.197 inch
Height from upper-edge of DIN-rail	52,5 mm / 2.067 inch
Depth	53 mm / 2.087 inch

### Mechanical data

Design	horizontal type
Mounting type	DIN-35 rail

Supus modificărilor.

WAGO Kontakttechnik GmbH & Co. KG  
/Representative Office Romania  
Sos. Pipera-Tunari nr. 1/1  
building 1, 2nd floor | 077190 Voluntari, Ilfov  
Tel.: +40-(0)31 421 85 68 | Email: info-RO@wago.com

Aveți întrebări despre produsele noastre?  
Vă stăm la dispoziție pentru preluarea apelului la +40 (0) 31 421 85 68.

Marking level

Center marking

## Material Data



Color	gray
Insulation material	Polyamide 66 (PA 66)
Weight	10,9g

## Commercial data



Product Group	1 (Rail Mounted Terminal Blocks)
Packaging type	BOX
Country of origin	DE
GTIN	4044918691369
Customs tariff number	85369010000

## Aprobări / certificate

### Country specific Approvals

Emblemă	Aprobare	Text de aprobare suplimentar	Nume certificat
	CCA DEKRA Certification B.V.	EN 60947	2157201.01
	CSA DEKRA Certification B.V.	C22.2	1536071

### Ship Approvals

Emblemă	Aprobare	Text de aprobare suplimentar	Nume certificat
	ABS American Bureau of Shipping	EN 60947	20- HG1941090- PDA
	BV Bureau Veritas S.A.	EN 60947	07436/E0 BV
	DNV GL Det Norske Veritas, Germanischer Lloyd	-	TAE00001V2

Supus modificărilor.

WAGO Kontakttechnik GmbH & Co. KG  
/Representative Office Romania  
Sos. Pipera-Tunari nr. 1/1  
building 1, 2nd floor | 077190 Voluntari, Ilfov  
Tel.: +40-(0)31 421 85 68 | Email: info-RO@wago.com

Aveți întrebări despre produsele noastre?  
Vă stăm la dispoziție pentru preluarea apelului la +40 (0) 31 421 85 68.



LR  
Lloyds Register

EN 60947

91/20112  
(E9)

#### UL-Approvals

Emblemă	Aprobare	Text de aprobare suplimentar	Nume certificat
	UL Underwriters Laboratories Inc.	UL 1059	20170731- E45172

#### Counterpart

#### Produse compatibile

#### Jumper



Nr. articol: 210-103

Wire commoning chain; insulated; 50 connections; black

[www.wago.com/210-103](http://www.wago.com/210-103)

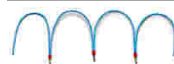

Nr. articol: 210-123

Wire commoning chain; insulated; 50 connections

[www.wago.com/210-123](http://www.wago.com/210-123)



Nr. articol: 280-482

Comb-style jumper bar; insulated; 2-way; IN = IN terminal block; gray

[www.wago.com/280-482](http://www.wago.com/280-482)



Nr. articol: 280-483



Comb-style jumper bar; insulated; 3-way; IN = IN terminal block; gray

[www.wago.com/280-483](http://www.wago.com/280-483)

Supus modificărilor.

WAGO Kontakttechnik GmbH & Co. KG  
/Representative Office Romania  
Sos. Pipera-Tunari nr. 1/1  
building 1, 2nd floor | 077190 Voluntari, Ilfov  
Tel.: +40-(0)31 421 85 68 | Email: [info-RO@wago.com](mailto:info-RO@wago.com)















Aveți întrebări despre produsele noastre?  
Vă stăm la dispoziție pentru preluarea apelului la +40 (0) 31 421 85 68.

	<b>Nr. articol: 280-484</b> Comb-style jumper bar; insulated; 4-way; IN = IN terminal block; gray	<a href="http://www.wago.com/280-484">www.wago.com/280-484</a>
	<b>Nr. articol: 280-485</b> Comb-style jumper bar; insulated; 5-way; IN = IN terminal block; gray	<a href="http://www.wago.com/280-485">www.wago.com/280-485</a>
	<b>Nr. articol: 280-490</b> Comb-style jumper bar; insulated; 10-way; IN = IN terminal block; gray	<a href="http://www.wago.com/280-490">www.wago.com/280-490</a>
	<b>Nr. articol: 280-492</b> Alternate comb-style jumper bar; insulated; 2-way; IN = IN terminal block; gray	<a href="http://www.wago.com/280-492">www.wago.com/280-492</a>
	<b>Nr. articol: 709-110</b> Wire commoning chain; insulated; 4 connections; 3 x 110 mm; black	<a href="http://www.wago.com/709-110">www.wago.com/709-110</a>
	<b>Nr. articol: 709-111</b> Wire commoning chain; insulated; 3 connections; 2 x 120 mm; black	<a href="http://www.wago.com/709-111">www.wago.com/709-111</a>
	<b>Nr. articol: 709-112</b> Wire commoning chain; insulated; 3 connections; 2 x 170 mm; black	<a href="http://www.wago.com/709-112">www.wago.com/709-112</a>
<b>General accessories</b>		
	<b>Nr. articol: 231-162/003-000</b> Male connector for rail-mount terminal blocks; 1.2 x 1.2 mm pins; straight; Pin spacing 5 mm; 2-pole; gray	<a href="http://www.wago.com/231-162/003-000">www.wago.com/231-162/003-000</a>
	<b>Nr. articol: 231-163/003-000</b> Male connector for rail-mount terminal blocks; 1.2 x 1.2 mm pins; straight; Pin spacing 5 mm; 3-pole; gray	<a href="http://www.wago.com/231-163/003-000">www.wago.com/231-163/003-000</a>
	<b>Nr. articol: 231-164/003-000</b> Male connector for rail-mount terminal blocks; 1.2 x 1.2 mm pins; straight; Pin spacing 5 mm; 4-pole; gray	<a href="http://www.wago.com/231-164/003-000">www.wago.com/231-164/003-000</a>
	<b>Nr. articol: 231-165/003-000</b> Male connector for rail-mount terminal blocks; 1.2 x 1.2 mm pins; straight; Pin spacing 5 mm; 5-pole; gray	<a href="http://www.wago.com/231-165/003-000">www.wago.com/231-165/003-000</a>
	<b>Nr. articol: 231-166/003-000</b> Male connector for rail-mount terminal blocks; 1.2 x 1.2 mm pins; straight; Pin spacing 5 mm; 6-pole; gray	<a href="http://www.wago.com/231-166/003-000">www.wago.com/231-166/003-000</a>
	<b>Nr. articol: 231-167/003-000</b> Male connector for rail-mount terminal blocks; 1.2 x 1.2 mm pins; straight; Pin spacing 5 mm; 7-pole; gray	<a href="http://www.wago.com/231-167/003-000">www.wago.com/231-167/003-000</a>
	<b>Nr. articol: 231-168/003-000</b> Male connector for rail-mount terminal blocks; 1.2 x 1.2 mm pins; straight; Pin spacing 5 mm; 8-pole; gray	<a href="http://www.wago.com/231-168/003-000">www.wago.com/231-168/003-000</a>
	<b>Nr. articol: 231-169/003-000</b> Male connector for rail-mount terminal blocks; 1.2 x 1.2 mm pins; straight; Pin spacing 5 mm; 9-pole; gray	<a href="http://www.wago.com/231-169/003-000">www.wago.com/231-169/003-000</a>















Supus modificărilor.

WAGO Kontakttechnik GmbH & Co. KG  
/Representative Office Romania  
Sos. Pipera-Tunari nr. 1/1  
building 1, 2nd floor | 077190 Voluntari, Ilfov  
Tel.: +40-(0)31 421 85 68 | Email: info-RO@wago.com













Aveți întrebări despre produsele noastre?  
Vă stăm la dispoziție pentru preluarea apelului la +40 (0) 31 421 85 68.

	<b>Nr. articol: 231-170/003-000</b> Male connector for rail-mount terminal blocks; 1.2 x 1.2 mm pins; straight; Pin spacing 5 mm; 10-pole; gray	<a href="http://www.wago.com/231-170/003-000">www.wago.com/231-170/003-000</a>
	<b>Nr. articol: 231-171/003-000</b> Male connector for rail-mount terminal blocks; 1.2 x 1.2 mm pins; straight; Pin spacing 5 mm; 11-pole; gray	<a href="http://www.wago.com/231-171/003-000">www.wago.com/231-171/003-000</a>
	<b>Nr. articol: 231-172/003-000</b> Male connector for rail-mount terminal blocks; 1.2 x 1.2 mm pins; straight; Pin spacing 5 mm; 12-pole; gray	<a href="http://www.wago.com/231-172/003-000">www.wago.com/231-172/003-000</a>
	<b>Nr. articol: 231-176/003-000</b> Male connector for rail-mount terminal blocks; 1.2 x 1.2 mm pins; straight; Pin spacing 5 mm; 16-pole; gray	<a href="http://www.wago.com/231-176/003-000">www.wago.com/231-176/003-000</a>
	<b>Nr. articol: 231-180/003-000</b> Male connector for rail-mount terminal blocks; 1.2 x 1.2 mm pins; straight; Pin spacing 5 mm; 20-pole; gray	<a href="http://www.wago.com/231-180/003-000">www.wago.com/231-180/003-000</a>
	<b>Nr. articol: 231-668</b> Lockout caps; for covering unused clamping units; gray	<a href="http://www.wago.com/231-668">www.wago.com/231-668</a>
	<b>Nr. articol: 231-669</b> Lockout caps; for covering unused clamping units; orange	<a href="http://www.wago.com/231-669">www.wago.com/231-669</a>
	<b>Nr. articol: 709-170</b> Disconnect lock; for disconnect tab used on 280/281 and 769 Series disconnect terminal blocks; red	<a href="http://www.wago.com/709-170">www.wago.com/709-170</a>
<b>tools</b>		
	<b>Nr. articol: 210-657</b> Operating tool; Blade: 3.5 x 0.5 mm; with a partially insulated shaft; short	<a href="http://www.wago.com/210-657">www.wago.com/210-657</a>
	<b>Nr. articol: 210-658</b> Operating tool; Blade: 3.5 x 0.5 mm; with a partially insulated shaft; angled; short	<a href="http://www.wago.com/210-658">www.wago.com/210-658</a>
	<b>Nr. articol: 210-720</b> Operating tool; Blade: 3.5 x 0.5 mm; with a partially insulated shaft	<a href="http://www.wago.com/210-720">www.wago.com/210-720</a>
<b>Marking accessories</b>		
	<b>Nr. articol: 2009-115</b> WMB-Inline; for Smart Printer; 1500 pieces on roll; stretchable 5 - 5.2 mm; plain; snap-on type; white	<a href="http://www.wago.com/2009-115">www.wago.com/2009-115</a>
	<b>Nr. articol: 2009-115/000-002</b> WMB-Inline; for Smart Printer; 1500 pieces on roll; stretchable 5 - 5.2 mm; plain; snap-on type; yellow	<a href="http://www.wago.com/2009-115/000-002">www.wago.com/2009-115/000-002</a>
	<b>Nr. articol: 2009-115/000-006</b> WMB-Inline; for Smart Printer; 1500 pieces on roll; stretchable 5 - 5.2 mm; plain; snap-on type; blue	<a href="http://www.wago.com/2009-115/000-006">www.wago.com/2009-115/000-006</a>
	<b>Nr. articol: 2009-115/000-007</b> WMB-Inline; for Smart Printer; 1500 pieces on roll; stretchable 5 - 5.2 mm; plain; snap-on type; gray	<a href="http://www.wago.com/2009-115/000-007">www.wago.com/2009-115/000-007</a>

Supus modificărilor.













	<b>Nr. articol: 2009-115/000-012</b> WMB-Inline; for Smart Printer; 1500 pieces on roll; stretchable 5 - 5.2 mm; plain; snap-on type; orange	<a href="http://www.wago.com/2009-115/000-012">www.wago.com/2009-115/000-012</a>
	<b>Nr. articol: 2009-115/000-017</b> WMB-Inline; for Smart Printer; 1500 pieces on roll; stretchable 5 - 5.2 mm; plain; snap-on type; light green	<a href="http://www.wago.com/2009-115/000-017">www.wago.com/2009-115/000-017</a>
	<b>Nr. articol: 2009-115/000-023</b> WMB-Inline; for Smart Printer; 1500 pieces on roll; stretchable 5 - 5.2 mm; plain; snap-on type; green	<a href="http://www.wago.com/2009-115/000-023">www.wago.com/2009-115/000-023</a>
	<b>Nr. articol: 2009-115/000-024</b> WMB-Inline; for Smart Printer; 1500 pieces on roll; stretchable 5 - 5.2 mm; plain; snap-on type; violet	<a href="http://www.wago.com/2009-115/000-024">www.wago.com/2009-115/000-024</a>
	<b>Nr. articol: 249-105</b> Group marker carrier; gray	<a href="http://www.wago.com/249-105">www.wago.com/249-105</a>
	<b>Nr. articol: 793-501</b> WMB marking card; as card; not stretchable; plain; snap-on type; white	<a href="http://www.wago.com/793-501">www.wago.com/793-501</a>
	<b>Nr. articol: 793-501/000-002</b> WMB marking card; as card; not stretchable; plain; snap-on type; yellow	<a href="http://www.wago.com/793-501/000-002">www.wago.com/793-501/000-002</a>
	<b>Nr. articol: 793-501/000-005</b> WMB marking card; as card; not stretchable; plain; snap-on type; red	<a href="http://www.wago.com/793-501/000-005">www.wago.com/793-501/000-005</a>
	<b>Nr. articol: 793-501/000-006</b> WMB marking card; as card; not stretchable; plain; snap-on type; blue	<a href="http://www.wago.com/793-501/000-006">www.wago.com/793-501/000-006</a>
	<b>Nr. articol: 793-501/000-007</b> WMB marking card; as card; not stretchable; plain; snap-on type; gray	<a href="http://www.wago.com/793-501/000-007">www.wago.com/793-501/000-007</a>
	<b>Nr. articol: 793-501/000-012</b> WMB marking card; as card; not stretchable; plain; snap-on type; orange	<a href="http://www.wago.com/793-501/000-012">www.wago.com/793-501/000-012</a>
	<b>Nr. articol: 793-501/000-017</b> WMB marking card; as card; not stretchable; plain; snap-on type; light green	<a href="http://www.wago.com/793-501/000-017">www.wago.com/793-501/000-017</a>
	<b>Nr. articol: 793-501/000-023</b> WMB marking card; as card; not stretchable; plain; snap-on type; green	<a href="http://www.wago.com/793-501/000-023">www.wago.com/793-501/000-023</a>
	<b>Nr. articol: 793-501/000-024</b> WMB marking card; as card; not stretchable; plain; snap-on type; violet	<a href="http://www.wago.com/793-501/000-024">www.wago.com/793-501/000-024</a>

Supus modificărilor.













	<b>Nr. articol: 793-5501</b> WMB marking card; as card; for terminal block width 5 - 17.5 mm; stretchable 5 - 5.2 mm; plain; snap-on type; white	<a href="http://www.wago.com/793-5501">www.wago.com/793-5501</a>
	<b>Nr. articol: 793-5501/000-002</b> WMB marking card; as card; for terminal block width 5 - 17.5 mm; stretchable 5 - 5.2 mm; plain; snap-on type; yellow	<a href="http://www.wago.com/793-5501/000-002">www.wago.com/793-5501/000-002</a>
	<b>Nr. articol: 793-5501/000-005</b> WMB marking card; as card; for terminal block width 5 - 17.5 mm; stretchable 5 - 5.2 mm; plain; snap-on type; red	<a href="http://www.wago.com/793-5501/000-005">www.wago.com/793-5501/000-005</a>
	<b>Nr. articol: 793-5501/000-006</b> WMB marking card; as card; for terminal block width 5 - 17.5 mm; stretchable 5 - 5.2 mm; plain; snap-on type; blue	<a href="http://www.wago.com/793-5501/000-006">www.wago.com/793-5501/000-006</a>
	<b>Nr. articol: 793-5501/000-007</b> WMB marking card; as card; for terminal block width 5 - 17.5 mm; stretchable 5 - 5.2 mm; plain; snap-on type; gray	<a href="http://www.wago.com/793-5501/000-007">www.wago.com/793-5501/000-007</a>
	<b>Nr. articol: 793-5501/000-012</b> WMB marking card; as card; for terminal block width 5 - 17.5 mm; stretchable 5 - 5.2 mm; plain; snap-on type; orange	<a href="http://www.wago.com/793-5501/000-012">www.wago.com/793-5501/000-012</a>
	<b>Nr. articol: 793-5501/000-017</b> WMB marking card; as card; for terminal block width 5 - 17.5 mm; stretchable 5 - 5.2 mm; plain; snap-on type; green	<a href="http://www.wago.com/793-5501/000-017">www.wago.com/793-5501/000-017</a>
	<b>Nr. articol: 793-5501/000-023</b> WMB marking card; as card; for terminal block width 5 - 17.5 mm; stretchable 5 - 5.2 mm; plain; snap-on type; light green	<a href="http://www.wago.com/793-5501/000-023">www.wago.com/793-5501/000-023</a>
	<b>Nr. articol: 793-5501/000-024</b> WMB marking card; as card; for terminal block width 5 - 17.5 mm; stretchable 5 - 5.2 mm; plain; snap-on type; violet	<a href="http://www.wago.com/793-5501/000-024">www.wago.com/793-5501/000-024</a>
<b>assembling</b>		
	<b>Nr. articol: 209-106</b> Mounting carrier; for isolated mounting on DIN 35 rails; gray	<a href="http://www.wago.com/209-106">www.wago.com/209-106</a>
	<b>Nr. articol: 210-148</b> Angled support bracket; without screw	<a href="http://www.wago.com/210-148">www.wago.com/210-148</a>
	<b>Nr. articol: 709-153</b> Cover; Type 1; suitable for cover carrier, type 1; 1 m long; transparent	<a href="http://www.wago.com/709-153">www.wago.com/709-153</a>
<b>Female plug</b>		
	<b>Nr. articol: 232-132/005-000</b> Female connector for rail-mount terminal blocks; 0.6 x 1 mm pins; straight; Pin spacing 5 mm; 2-pole; gray	<a href="http://www.wago.com/232-132/005-000">www.wago.com/232-132/005-000</a>
<b>Nr. articol: 232-132/005-000/039-000</b>		

Supus modificărilor.















	Female connector for rail-mount terminal blocks; 0.6 x 1 mm pins; straight; Locking lever; Pin spacing 5 mm; 2-pole; gray	<a href="http://www.wago.com/232-133/005-000/039-000">www.wago.com/232-133/005-000/039-000</a>
	<b>Nr. articol: 232-133/005-000</b> Female connector for rail-mount terminal blocks; 0.6 x 1 mm pins; straight; Pin spacing 5 mm; 3-pole; gray	<a href="http://www.wago.com/232-133/005-000">www.wago.com/232-133/005-000</a>
	<b>Nr. articol: 232-133/005-000/039-000</b> Female connector for rail-mount terminal blocks; 0.6 x 1 mm pins; straight; Locking lever; Pin spacing 5 mm; 3-pole; gray	<a href="http://www.wago.com/232-133/005-000/039-000">www.wago.com/232-133/005-000/039-000</a>
	<b>Nr. articol: 232-134/005-000</b> Female connector for rail-mount terminal blocks; 0.6 x 1 mm pins; straight; Pin spacing 5 mm; 4-pole; gray	<a href="http://www.wago.com/232-134/005-000">www.wago.com/232-134/005-000</a>
	<b>Nr. articol: 232-134/005-000/039-000</b> Female connector for rail-mount terminal blocks; 0.6 x 1 mm pins; straight; Locking lever; Pin spacing 5 mm; 4-pole; gray	<a href="http://www.wago.com/232-134/005-000/039-000">www.wago.com/232-134/005-000/039-000</a>
	<b>Nr. articol: 232-135/005-000</b> Female connector for rail-mount terminal blocks; 0.6 x 1 mm pins; straight; Pin spacing 5 mm; 5-pole; gray	<a href="http://www.wago.com/232-135/005-000">www.wago.com/232-135/005-000</a>
	<b>Nr. articol: 232-135/005-000/039-000</b> Female connector for rail-mount terminal blocks; 0.6 x 1 mm pins; straight; Locking lever; Pin spacing 5 mm; 5-pole; gray	<a href="http://www.wago.com/232-135/005-000/039-000">www.wago.com/232-135/005-000/039-000</a>
	<b>Nr. articol: 232-136/005-000</b> Female connector for rail-mount terminal blocks; 0.6 x 1 mm pins; straight; Pin spacing 5 mm; 6-pole; gray	<a href="http://www.wago.com/232-136/005-000">www.wago.com/232-136/005-000</a>
	<b>Nr. articol: 232-136/005-000/039-000</b> Female connector for rail-mount terminal blocks; 0.6 x 1 mm pins; straight; Locking lever; Pin spacing 5 mm; 6-pole; gray	<a href="http://www.wago.com/232-136/005-000/039-000">www.wago.com/232-136/005-000/039-000</a>
	<b>Nr. articol: 232-137/005-000</b> Female connector for rail-mount terminal blocks; 0.6 x 1 mm pins; straight; Pin spacing 5 mm; 7-pole; gray	<a href="http://www.wago.com/232-137/005-000">www.wago.com/232-137/005-000</a>
	<b>Nr. articol: 232-137/005-000/039-000</b> Female connector for rail-mount terminal blocks; 0.6 x 1 mm pins; straight; Locking lever; Pin spacing 5 mm; 7-pole; gray	<a href="http://www.wago.com/232-137/005-000/039-000">www.wago.com/232-137/005-000/039-000</a>
	<b>Nr. articol: 232-138/005-000</b> Female connector for rail-mount terminal blocks; 0.6 x 1 mm pins; straight; Pin spacing 5 mm; 8-pole; gray	<a href="http://www.wago.com/232-138/005-000">www.wago.com/232-138/005-000</a>
	<b>Nr. articol: 232-138/005-000/039-000</b> Female connector for rail-mount terminal blocks; 0.6 x 1 mm pins; straight; Locking lever; Pin spacing 5 mm; 8-pole; gray	<a href="http://www.wago.com/232-138/005-000/039-000">www.wago.com/232-138/005-000/039-000</a>
	<b>Nr. articol: 232-139/005-000</b>	

Supus modificărilor.













	Female connector for rail-mount terminal blocks; 0.6 x 1 mm pins; straight; Pin spacing 5 mm; 9-pole; gray	<a href="http://www.wago.com/232-139/005-000">www.wago.com/232-139/005-000</a>
	<b>Nr. articol: 232-139/005-000/039-000</b> Female connector for rail-mount terminal blocks; 0.6 x 1 mm pins; straight; Locking lever; Pin spacing 5 mm; 9-pole; gray	<a href="http://www.wago.com/232-139/005-000/039-000">www.wago.com/232-139/005-000/039-000</a>
	<b>Nr. articol: 232-140/005-000</b> Female connector for rail-mount terminal blocks; 0.6 x 1 mm pins; straight; Pin spacing 5 mm; 10-pole; gray	<a href="http://www.wago.com/232-140/005-000">www.wago.com/232-140/005-000</a>
	<b>Nr. articol: 232-140/005-000/039-000</b> Female connector for rail-mount terminal blocks; 0.6 x 1 mm pins; straight; Locking lever; Pin spacing 5 mm; 10-pole; gray	<a href="http://www.wago.com/232-140/005-000/039-000">www.wago.com/232-140/005-000/039-000</a>
	<b>Nr. articol: 232-142/005-000</b> Female connector for rail-mount terminal blocks; 0.6 x 1 mm pins; straight; Pin spacing 5 mm; 12-pole; gray	<a href="http://www.wago.com/232-142/005-000">www.wago.com/232-142/005-000</a>
	<b>Nr. articol: 232-142/005-000/039-000</b> Female connector for rail-mount terminal blocks; 0.6 x 1 mm pins; straight; Locking lever; Pin spacing 5 mm; 12-pole; gray	<a href="http://www.wago.com/232-142/005-000/039-000">www.wago.com/232-142/005-000/039-000</a>
	<b>Nr. articol: 232-146/005-000</b> Female connector for rail-mount terminal blocks; 0.6 x 1 mm pins; straight; Pin spacing 5 mm; 16-pole; gray	<a href="http://www.wago.com/232-146/005-000">www.wago.com/232-146/005-000</a>
	<b>Nr. articol: 232-146/005-000/039-000</b> Female connector for rail-mount terminal blocks; 0.6 x 1 mm pins; straight; Locking lever; Pin spacing 5 mm; 16-pole; gray	<a href="http://www.wago.com/232-146/005-000/039-000">www.wago.com/232-146/005-000/039-000</a>
	<b>Nr. articol: 232-147/005-000/039-000</b> Female connector for rail-mount terminal blocks; 0.6 x 1 mm pins; straight; Locking lever; Pin spacing 5 mm; 17-pole; gray	<a href="http://www.wago.com/232-147/005-000/039-000">www.wago.com/232-147/005-000/039-000</a>
	<b>Nr. articol: 232-150/005-000</b> Female connector for rail-mount terminal blocks; 0.6 x 1 mm pins; straight; Pin spacing 5 mm; 20-pole; gray	<a href="http://www.wago.com/232-150/005-000">www.wago.com/232-150/005-000</a>
	<b>Nr. articol: 232-150/005-000/039-000</b> Female connector for rail-mount terminal blocks; 0.6 x 1 mm pins; straight; Locking lever; Pin spacing 5 mm; 20-pole; gray	<a href="http://www.wago.com/232-150/005-000/039-000">www.wago.com/232-150/005-000/039-000</a>
	<b>Nr. articol: 232-232/005-000</b> Female connector for rail-mount terminal blocks; 0.6 x 1 mm pins; angled; Pin spacing 5 mm; 2-pole; gray	<a href="http://www.wago.com/232-232/005-000">www.wago.com/232-232/005-000</a>
	<b>Nr. articol: 232-232/005-000/039-000</b> Female connector for rail-mount terminal blocks; 0.6 x 1 mm pins; angled; Locking lever; Pin spacing 5 mm; 2-pole; gray	<a href="http://www.wago.com/232-232/005-000/039-000">www.wago.com/232-232/005-000/039-000</a>

**Nr. articol: 232-233/005-000**

Supus modificărilor.

	Female connector for rail-mount terminal blocks; 0.6 x 1 mm pins; angled; Pin spacing 5 mm; 3-pole; gray	<a href="http://www.wago.com/232-233/005-000">www.wago.com/232-233/005-000</a>
	<b>Nr. articol: 232-233/005-000/039-000</b> Female connector for rail-mount terminal blocks; 0.6 x 1 mm pins; angled; Locking lever; Pin spacing 5 mm; 3-pole; gray	<a href="http://www.wago.com/232-233/005-000/039-000">www.wago.com/232-233/005-000/039-000</a>
	<b>Nr. articol: 232-234/005-000</b> Female connector for rail-mount terminal blocks; 0.6 x 1 mm pins; angled; Pin spacing 5 mm; 4-pole; gray	<a href="http://www.wago.com/232-234/005-000">www.wago.com/232-234/005-000</a>
	<b>Nr. articol: 232-234/005-000/039-000</b> Female connector for rail-mount terminal blocks; 0.6 x 1 mm pins; angled; Locking lever; Pin spacing 5 mm; 4-pole; gray	<a href="http://www.wago.com/232-234/005-000/039-000">www.wago.com/232-234/005-000/039-000</a>
	<b>Nr. articol: 232-235/005-000</b> Female connector for rail-mount terminal blocks; 0.6 x 1 mm pins; angled; Pin spacing 5 mm; 5-pole; gray	<a href="http://www.wago.com/232-235/005-000">www.wago.com/232-235/005-000</a>
	<b>Nr. articol: 232-235/005-000/039-000</b> Female connector for rail-mount terminal blocks; 0.6 x 1 mm pins; angled; Locking lever; Pin spacing 5 mm; 5-pole; gray	<a href="http://www.wago.com/232-235/005-000/039-000">www.wago.com/232-235/005-000/039-000</a>
	<b>Nr. articol: 232-236/005-000</b> Female connector for rail-mount terminal blocks; 0.6 x 1 mm pins; angled; Pin spacing 5 mm; 6-pole; gray	<a href="http://www.wago.com/232-236/005-000">www.wago.com/232-236/005-000</a>
	<b>Nr. articol: 232-236/005-000/039-000</b> Female connector for rail-mount terminal blocks; 0.6 x 1 mm pins; angled; Locking lever; Pin spacing 5 mm; 6-pole; gray	<a href="http://www.wago.com/232-236/005-000/039-000">www.wago.com/232-236/005-000/039-000</a>
	<b>Nr. articol: 232-237/005-000</b> Female connector for rail-mount terminal blocks; 0.6 x 1 mm pins; angled; Pin spacing 5 mm; 7-pole; gray	<a href="http://www.wago.com/232-237/005-000">www.wago.com/232-237/005-000</a>
	<b>Nr. articol: 232-238/005-000</b> Female connector for rail-mount terminal blocks; 0.6 x 1 mm pins; angled; Pin spacing 5 mm; 8-pole; gray	<a href="http://www.wago.com/232-238/005-000">www.wago.com/232-238/005-000</a>
	<b>Nr. articol: 232-239/005-000</b> Female connector for rail-mount terminal blocks; 0.6 x 1 mm pins; angled; Pin spacing 5 mm; 9-pole; gray	<a href="http://www.wago.com/232-239/005-000">www.wago.com/232-239/005-000</a>
	<b>Nr. articol: 232-240/005-000</b> Female connector for rail-mount terminal blocks; 0.6 x 1 mm pins; angled; Pin spacing 5 mm; 10-pole; gray	<a href="http://www.wago.com/232-240/005-000">www.wago.com/232-240/005-000</a>
	<b>Nr. articol: 232-240/005-000/039-000</b> Female connector for rail-mount terminal blocks; 0.6 x 1 mm pins; angled; Locking lever; Pin spacing 5 mm; 10-pole; gray	<a href="http://www.wago.com/232-240/005-000/039-000">www.wago.com/232-240/005-000/039-000</a>
	<b>Nr. articol: 232-242/005-000</b>	

Supus modificărilor.

	Female connector for rail-mount terminal blocks; 0.6 x 1 mm pins; angled; Pin spacing 5 mm; 12-pole; gray	<a href="http://www.wago.com/232-242/005-000">www.wago.com/232-242/005-000</a>
	<b>Nr. articol: 232-242/005-000/039-000</b> Female connector for rail-mount terminal blocks; 0.6 x 1 mm pins; angled; Locking lever; Pin spacing 5 mm; 12-pole; gray	<a href="http://www.wago.com/232-242/005-000/039-000">www.wago.com/232-242/005-000/039-000</a>
	<b>Nr. articol: 232-246/005-000</b> Female connector for rail-mount terminal blocks; 0.6 x 1 mm pins; angled; Pin spacing 5 mm; 16-pole; gray	<a href="http://www.wago.com/232-246/005-000">www.wago.com/232-246/005-000</a>
	<b>Nr. articol: 232-246/005-000/039-000</b> Female connector for rail-mount terminal blocks; 0.6 x 1 mm pins; angled; Locking lever; Pin spacing 5 mm; 16-pole; gray	<a href="http://www.wago.com/232-246/005-000/039-000">www.wago.com/232-246/005-000/039-000</a>
	<b>Nr. articol: 232-250/005-000</b> Female connector for rail-mount terminal blocks; 0.6 x 1 mm pins; angled; Pin spacing 5 mm; 20-pole; gray	<a href="http://www.wago.com/232-250/005-000">www.wago.com/232-250/005-000</a>
	<b>Nr. articol: 232-250/005-000/039-000</b> Female connector for rail-mount terminal blocks; 0.6 x 1 mm pins; angled; Locking lever; Pin spacing 5 mm; 20-pole; gray	<a href="http://www.wago.com/232-250/005-000/039-000">www.wago.com/232-250/005-000/039-000</a>
	<b>Nr. articol: 232-732/005-000</b> THT female header; 0.6 x 1.0 mm solder pin; gray	<a href="http://www.wago.com/232-732/005-000">www.wago.com/232-732/005-000</a>
	<b>Nr. articol: 232-733/005-000</b> THT female header; 0.6 x 1.0 mm solder pin; gray	<a href="http://www.wago.com/232-733/005-000">www.wago.com/232-733/005-000</a>
	<b>Nr. articol: 232-734/005-000</b> THT female header; 0.6 x 1.0 mm solder pin; gray	<a href="http://www.wago.com/232-734/005-000">www.wago.com/232-734/005-000</a>
	<b>Nr. articol: 232-734/005-000/039-000</b> THT female header; 0.6 x 1.0 mm solder pin; gray	<a href="http://www.wago.com/232-734/005-000/039-000">www.wago.com/232-734/005-000/039-000</a>
	<b>Nr. articol: 232-735/005-000</b> THT female header; 0.6 x 1.0 mm solder pin; gray	<a href="http://www.wago.com/232-735/005-000">www.wago.com/232-735/005-000</a>
	<b>Nr. articol: 232-735/005-000/039-000</b> THT female header; 0.6 x 1.0 mm solder pin; gray	<a href="http://www.wago.com/232-735/005-000/039-000">www.wago.com/232-735/005-000/039-000</a>
	<b>Nr. articol: 232-736/005-000</b> THT female header; 0.6 x 1.0 mm solder pin; gray	<a href="http://www.wago.com/232-736/005-000">www.wago.com/232-736/005-000</a>

Supus modificărilor.



**Nr. articol: 232-736/005-000/039-000**  
THT female header; 0.6 x 1.0 mm solder pin; gray

[www.wago.com/232-736/005-000/039-000](http://www.wago.com/232-736/005-000/039-000)



**Nr. articol: 232-738/005-000**  
THT female header; 0.6 x 1.0 mm solder pin; gray

[www.wago.com/232-738/005-000](http://www.wago.com/232-738/005-000)



**Nr. articol: 232-740/005-000**  
THT female header; 0.6 x 1.0 mm solder pin; gray

[www.wago.com/232-740/005-000](http://www.wago.com/232-740/005-000)



**Nr. articol: 232-742/005-000**  
THT female header; 0.6 x 1.0 mm solder pin; gray

[www.wago.com/232-742/005-000](http://www.wago.com/232-742/005-000)



**Nr. articol: 232-832/005-000**  
THT female header; 0.6 x 1.0 mm solder pin; angled; Pin spacing 7.5 mm; 2-pole; gray

[www.wago.com/232-832/005-000](http://www.wago.com/232-832/005-000)



**Nr. articol: 232-833/005-000**  
THT female header; 0.6 x 1.0 mm solder pin; angled; Pin spacing 7.5 mm; 3-pole; gray

[www.wago.com/232-833/005-000](http://www.wago.com/232-833/005-000)



**Nr. articol: 232-834/005-000**  
THT female header; 0.6 x 1.0 mm solder pin; angled; Pin spacing 7.5 mm; 4-pole; gray

[www.wago.com/232-834/005-000](http://www.wago.com/232-834/005-000)



**Nr. articol: 232-836/005-000**  
THT female header; 0.6 x 1.0 mm solder pin; angled; Pin spacing 7.5 mm; 6-pole; gray

[www.wago.com/232-836/005-000](http://www.wago.com/232-836/005-000)



**Nr. articol: 232-836/005-000/039-000**  
THT female header; 0.6 x 1.0 mm solder pin; angled; Locking lever; Pin spacing 7.5 mm; 6-pole; gray

[www.wago.com/232-836/005-000/039-000](http://www.wago.com/232-836/005-000/039-000)



**Nr. articol: 232-840/005-000**  
THT female header; 0.6 x 1.0 mm solder pin; angled; Pin spacing 7.5 mm; 10-pole; gray

[www.wago.com/232-840/005-000](http://www.wago.com/232-840/005-000)



**Nr. articol: 232-842/005-000**  
THT female header; 0.6 x 1.0 mm solder pin; angled; Pin spacing 7.5 mm; 12-pole; gray

[www.wago.com/232-842/005-000](http://www.wago.com/232-842/005-000)



**Nr. articol: 722-132/005-000**  
Female connector for rail-mount terminal blocks; 0.6 x 1 mm pins; straight; 100% protected against mismatching; Pin spacing 5 mm; 2-pole; light gray

[www.wago.com/722-132/005-000](http://www.wago.com/722-132/005-000)













**Nr. articol: 722-132/005-000/039-000**  
Female connector for rail-mount terminal blocks; 0.6 x 1 mm pins; straight; 100% protected against mismatching; Locking lever; Pin spacing 5 mm; 2-pole; light gray

[www.wago.com/722-132/005-000/039-000](http://www.wago.com/722-132/005-000/039-000)

**Nr. articol: 722-133/005-000**

Supus modificărilor.

	Female connector for rail-mount terminal blocks; 0.6 x 1 mm pins; straight; 100% protected against mismatching; Pin spacing 5 mm; 3-pole; light gray	<a href="http://www.wago.com/722-133/005-000">www.wago.com/722-133/005-000</a>
	<b>Nr. articol: 722-133/005-000/039-000</b> Female connector for rail-mount terminal blocks; 0.6 x 1 mm pins; straight; 100% protected against mismatching; Locking lever; Pin spacing 5 mm; 3-pole; light gray	<a href="http://www.wago.com/722-133/005-000/039-000">www.wago.com/722-133/005-000/039-000</a>
	<b>Nr. articol: 722-134/005-000</b> Female connector for rail-mount terminal blocks; 0.6 x 1 mm pins; straight; 100% protected against mismatching; Pin spacing 5 mm; 4-pole; light gray	<a href="http://www.wago.com/722-134/005-000">www.wago.com/722-134/005-000</a>
	<b>Nr. articol: 722-134/005-000/039-000</b> Female connector for rail-mount terminal blocks; 0.6 x 1 mm pins; straight; 100% protected against mismatching; Locking lever; Pin spacing 5 mm; 4-pole; light gray	<a href="http://www.wago.com/722-134/005-000/039-000">www.wago.com/722-134/005-000/039-000</a>
	<b>Nr. articol: 722-135/005-000</b> Female connector for rail-mount terminal blocks; 0.6 x 1 mm pins; straight; 100% protected against mismatching; Pin spacing 5 mm; 5-pole; light gray	<a href="http://www.wago.com/722-135/005-000">www.wago.com/722-135/005-000</a>
	<b>Nr. articol: 722-135/005-000/039-000</b> Female connector for rail-mount terminal blocks; 0.6 x 1 mm pins; straight; 100% protected against mismatching; Locking lever; Pin spacing 5 mm; 5-pole; light gray	<a href="http://www.wago.com/722-135/005-000/039-000">www.wago.com/722-135/005-000/039-000</a>
	<b>Nr. articol: 722-136/005-000</b> Female connector for rail-mount terminal blocks; 0.6 x 1 mm pins; straight; 100% protected against mismatching; Pin spacing 5 mm; 6-pole; light gray	<a href="http://www.wago.com/722-136/005-000">www.wago.com/722-136/005-000</a>
	<b>Nr. articol: 722-136/005-000/039-000</b> Female connector for rail-mount terminal blocks; 0.6 x 1 mm pins; straight; 100% protected against mismatching; Locking lever; Pin spacing 5 mm; 6-pole; light gray	<a href="http://www.wago.com/722-136/005-000/039-000">www.wago.com/722-136/005-000/039-000</a>
	<b>Nr. articol: 722-137/005-000</b> Female connector for rail-mount terminal blocks; 0.6 x 1 mm pins; straight; 100% protected against mismatching; Pin spacing 5 mm; 7-pole; light gray	<a href="http://www.wago.com/722-137/005-000">www.wago.com/722-137/005-000</a>
	<b>Nr. articol: 722-137/005-000/039-000</b> Female connector for rail-mount terminal blocks; 0.6 x 1 mm pins; straight; 100% protected against mismatching; Locking lever; Pin spacing 5 mm; 7-pole; light gray	<a href="http://www.wago.com/722-137/005-000/039-000">www.wago.com/722-137/005-000/039-000</a>
	<b>Nr. articol: 722-138/005-000</b> Female connector for rail-mount terminal blocks; 0.6 x 1 mm pins; straight; 100% protected against mismatching; Pin spacing 5 mm; 8-pole; light gray	<a href="http://www.wago.com/722-138/005-000">www.wago.com/722-138/005-000</a>
	<b>Nr. articol: 722-138/005-000/039-000</b> Female connector for rail-mount terminal blocks; 0.6 x 1 mm pins; straight; 100% protected against mismatching; Locking lever; Pin spacing 5 mm; 8-pole; light gray	<a href="http://www.wago.com/722-138/005-000/039-000">www.wago.com/722-138/005-000/039-000</a>
	<b>Nr. articol: 722-139/005-000</b> Female connector for rail-mount terminal blocks; 0.6 x 1 mm pins; straight; 100% protected against mismatching; Pin spacing 5 mm; 9-pole; light gray	<a href="http://www.wago.com/722-139/005-000">www.wago.com/722-139/005-000</a>
	<b>Nr. articol: 722-139/005-000/039-000</b>	

Supus modificărilor.

WAGO Kontakttechnik GmbH & Co. KG  
 /Representative Office Romania  
 Sos. Pipera-Tunari nr. 1/1  
 building 1, 2nd floor | 077190 Voluntari, Ilfov  
 Tel.: +40-(0)31 421 85 68 | Email: info-RO@wago.com

Aveți întrebări despre produsele noastre?  
 Vă stăm la dispoziție pentru preluarea apelului la +40 (0) 31 421 85 68.



Female connector for rail-mount terminal blocks; 0.6 x 1 mm pins; straight; 100% protected against mismatching; Locking lever; Pin spacing 5 mm; 9-pole; light gray

[www.wago.com/722-139/005-000/039-000](http://www.wago.com/722-139/005-000/039-000)



**Nr. articol: 722-140/005-000**

Female connector for rail-mount terminal blocks; 0.6 x 1 mm pins; straight; 100% protected against mismatching; Pin spacing 5 mm; 10-pole; light gray

[www.wago.com/722-140/005-000](http://www.wago.com/722-140/005-000)



**Nr. articol: 722-140/005-000/039-000**

Female connector for rail-mount terminal blocks; 0.6 x 1 mm pins; straight; 100% protected against mismatching; Locking lever; Pin spacing 5 mm; 10-pole; light gray

[www.wago.com/722-140/005-000/039-000](http://www.wago.com/722-140/005-000/039-000)



**Nr. articol: 722-141/005-000**

Female connector for rail-mount terminal blocks; 0.6 x 1 mm pins; straight; 100% protected against mismatching; Pin spacing 5 mm; 11-pole; light gray

[www.wago.com/722-141/005-000](http://www.wago.com/722-141/005-000)



**Nr. articol: 722-142/005-000**

Female connector for rail-mount terminal blocks; 0.6 x 1 mm pins; straight; 100% protected against mismatching; Pin spacing 5 mm; 12-pole; light gray

[www.wago.com/722-142/005-000](http://www.wago.com/722-142/005-000)



**Nr. articol: 722-142/005-007/039-000**

Female connector for rail-mount terminal blocks; gray

[www.wago.com/722-142/005-007/039-000](http://www.wago.com/722-142/005-007/039-000)



**Nr. articol: 722-143/005-000**

Female connector for rail-mount terminal blocks; 0.6 x 1 mm pins; straight; 100% protected against mismatching; Pin spacing 5 mm; 13-pole; light gray

[www.wago.com/722-143/005-000](http://www.wago.com/722-143/005-000)



**Nr. articol: 722-144/005-000**

Female connector for rail-mount terminal blocks; 0.6 x 1 mm pins; straight; 100% protected against mismatching; Pin spacing 5 mm; 14-pole; light gray

[www.wago.com/722-144/005-000](http://www.wago.com/722-144/005-000)



**Nr. articol: 722-144/005-000/039-000**

Female connector for rail-mount terminal blocks; 0.6 x 1 mm pins; straight; 100% protected against mismatching; Locking lever; Pin spacing 5 mm; 14-pole; light gray

[www.wago.com/722-144/005-000/039-000](http://www.wago.com/722-144/005-000/039-000)



**Nr. articol: 722-145/005-000**

Female connector for rail-mount terminal blocks; 0.6 x 1 mm pins; straight; 100% protected against mismatching; Pin spacing 5 mm; 15-pole; light gray

[www.wago.com/722-145/005-000](http://www.wago.com/722-145/005-000)



**Nr. articol: 722-146/005-000**

Female connector for rail-mount terminal blocks; 0.6 x 1 mm pins; straight; 100% protected against mismatching; Pin spacing 5 mm; 16-pole; light gray

[www.wago.com/722-146/005-000](http://www.wago.com/722-146/005-000)



**Nr. articol: 722-146/005-000/039-000**

Female connector for rail-mount terminal blocks; 0.6 x 1 mm pins; straight; 100% protected against mismatching; Locking lever; Pin spacing 5 mm; 16-pole; light gray

[www.wago.com/722-146/005-000/039-000](http://www.wago.com/722-146/005-000/039-000)















**Nr. articol: 722-150/005-000**

Female connector for rail-mount terminal blocks; 0.6 x 1 mm pins; straight; 100% protected against mismatching; Pin spacing 5 mm; 20-pole; light gray

[www.wago.com/722-150/005-000](http://www.wago.com/722-150/005-000)

**Nr. articol: 722-150/005-000/039-000**

Supus modificărilor.













	Female connector for rail-mount terminal blocks; 0.6 x 1 mm pins; straight; 100% protected against mismatching; Locking lever; Pin spacing 5 mm; 20-pole; light gray	<a href="http://www.wago.com/722-150/005-000/039-000">www.wago.com/722-150/005-000/039-000</a>
	<b>Nr. articol: 722-232/005-000</b> Female connector for rail-mount terminal blocks; 0.6 x 1 mm pins; angled; 100% protected against mismatching; Pin spacing 5 mm; 2-pole; light gray	<a href="http://www.wago.com/722-232/005-000">www.wago.com/722-232/005-000</a>
	<b>Nr. articol: 722-232/005-000/039-000</b> Female connector for rail-mount terminal blocks; 0.6 x 1 mm pins; angled; 100% protected against mismatching; Locking lever; Pin spacing 5 mm; 2-pole; light gray	<a href="http://www.wago.com/722-232/005-000/039-000">www.wago.com/722-232/005-000/039-000</a>
	<b>Nr. articol: 722-233/005-000</b> Female connector for rail-mount terminal blocks; 0.6 x 1 mm pins; angled; 100% protected against mismatching; Pin spacing 5 mm; 3-pole; light gray	<a href="http://www.wago.com/722-233/005-000">www.wago.com/722-233/005-000</a>
	<b>Nr. articol: 722-233/005-000/039-000</b> Female connector for rail-mount terminal blocks; 0.6 x 1 mm pins; angled; 100% protected against mismatching; Locking lever; Pin spacing 5 mm; 3-pole; light gray	<a href="http://www.wago.com/722-233/005-000/039-000">www.wago.com/722-233/005-000/039-000</a>
	<b>Nr. articol: 722-234/005-000</b> Female connector for rail-mount terminal blocks; 0.6 x 1 mm pins; angled; 100% protected against mismatching; Pin spacing 5 mm; 4-pole; light gray	<a href="http://www.wago.com/722-234/005-000">www.wago.com/722-234/005-000</a>
	<b>Nr. articol: 722-234/005-000/039-000</b> Female connector for rail-mount terminal blocks; 0.6 x 1 mm pins; angled; 100% protected against mismatching; Locking lever; Pin spacing 5 mm; 4-pole; light gray	<a href="http://www.wago.com/722-234/005-000/039-000">www.wago.com/722-234/005-000/039-000</a>
	<b>Nr. articol: 722-235/005-000</b> Female connector for rail-mount terminal blocks; 0.6 x 1 mm pins; angled; 100% protected against mismatching; Pin spacing 5 mm; 5-pole; light gray	<a href="http://www.wago.com/722-235/005-000">www.wago.com/722-235/005-000</a>
	<b>Nr. articol: 722-235/005-000/039-000</b> Female connector for rail-mount terminal blocks; 0.6 x 1 mm pins; angled; 100% protected against mismatching; Locking lever; Pin spacing 5 mm; 5-pole; light gray	<a href="http://www.wago.com/722-235/005-000/039-000">www.wago.com/722-235/005-000/039-000</a>
	<b>Nr. articol: 722-236/005-000</b> Female connector for rail-mount terminal blocks; 0.6 x 1 mm pins; angled; 100% protected against mismatching; Pin spacing 5 mm; 6-pole; light gray	<a href="http://www.wago.com/722-236/005-000">www.wago.com/722-236/005-000</a>
	<b>Nr. articol: 722-236/005-000/039-000</b> Female connector for rail-mount terminal blocks; 0.6 x 1 mm pins; angled; 100% protected against mismatching; Locking lever; Pin spacing 5 mm; 6-pole; light gray	<a href="http://www.wago.com/722-236/005-000/039-000">www.wago.com/722-236/005-000/039-000</a>
	<b>Nr. articol: 722-237/005-000</b> Female connector for rail-mount terminal blocks; 0.6 x 1 mm pins; angled; 100% protected against mismatching; Pin spacing 5 mm; 7-pole; light gray	<a href="http://www.wago.com/722-237/005-000">www.wago.com/722-237/005-000</a>
	<b>Nr. articol: 722-237/005-000/039-000</b> Female connector for rail-mount terminal blocks; 0.6 x 1 mm pins; angled; 100% protected against mismatching; Locking lever; Pin spacing 5 mm; 7-pole; light gray	<a href="http://www.wago.com/722-237/005-000/039-000">www.wago.com/722-237/005-000/039-000</a>
	<b>Nr. articol: 722-238/005-000</b>	

Supus modificărilor.

WAGO Kontakttechnik GmbH & Co. KG  
 /Representative Office Romania  
 Sos. Pipera-Tunari nr. 1/1  
 building 1, 2nd floor | 077190 Voluntari, Ilfov  
 Tel.: +40-(0)31 421 85 68 | Email: info-RO@wago.com

Aveți întrebări despre produsele noastre?  
 Vă stăm la dispoziție pentru preluarea apelului la +40 (0) 31 421 85 68.



	Female connector for rail-mount terminal blocks; 0.6 x 1 mm pins; angled; 100% protected against mismatching; Pin spacing 5 mm; 8-pole; light gray	<a href="http://www.wago.com/722-238/005-000">www.wago.com/722-238/005-000</a>
	<b>Nr. articol: 722-239/005-000</b> Female connector for rail-mount terminal blocks; 0.6 x 1 mm pins; angled; 100% protected against mismatching; Pin spacing 5 mm; 9-pole; light gray	<a href="http://www.wago.com/722-239/005-000">www.wago.com/722-239/005-000</a>
	<b>Nr. articol: 722-239/005-000/039-000</b> Female connector for rail-mount terminal blocks; 0.6 x 1 mm pins; angled; 100% protected against mismatching; Locking lever; Pin spacing 5 mm; 9-pole; light gray	<a href="http://www.wago.com/722-239/005-000/039-000">www.wago.com/722-239/005-000/039-000</a>
	<b>Nr. articol: 722-240/005-000</b> Female connector for rail-mount terminal blocks; 0.6 x 1 mm pins; angled; 100% protected against mismatching; Pin spacing 5 mm; 10-pole; light gray	<a href="http://www.wago.com/722-240/005-000">www.wago.com/722-240/005-000</a>
	<b>Nr. articol: 722-240/005-000/039-000</b> Female connector for rail-mount terminal blocks; 0.6 x 1 mm pins; angled; 100% protected against mismatching; Locking lever; Pin spacing 5 mm; 10-pole; light gray	<a href="http://www.wago.com/722-240/005-000/039-000">www.wago.com/722-240/005-000/039-000</a>
	<b>Nr. articol: 722-241/005-000</b> Female connector for rail-mount terminal blocks; 0.6 x 1 mm pins; angled; 100% protected against mismatching; Pin spacing 5 mm; 11-pole; light gray	<a href="http://www.wago.com/722-241/005-000">www.wago.com/722-241/005-000</a>
	<b>Nr. articol: 722-242/005-000</b> Female connector for rail-mount terminal blocks; 0.6 x 1 mm pins; angled; 100% protected against mismatching; Pin spacing 5 mm; 12-pole; light gray	<a href="http://www.wago.com/722-242/005-000">www.wago.com/722-242/005-000</a>
	<b>Nr. articol: 722-242/005-000/039-000</b> Female connector for rail-mount terminal blocks; 0.6 x 1 mm pins; angled; 100% protected against mismatching; Locking lever; Pin spacing 5 mm; 12-pole; light gray	<a href="http://www.wago.com/722-242/005-000/039-000">www.wago.com/722-242/005-000/039-000</a>
	<b>Nr. articol: 722-243/005-000</b> Female connector for rail-mount terminal blocks; 0.6 x 1 mm pins; angled; 100% protected against mismatching; Pin spacing 5 mm; 13-pole; light gray	<a href="http://www.wago.com/722-243/005-000">www.wago.com/722-243/005-000</a>
	<b>Nr. articol: 722-244/005-000</b> Female connector for rail-mount terminal blocks; 0.6 x 1 mm pins; angled; 100% protected against mismatching; Pin spacing 5 mm; 14-pole; light gray	<a href="http://www.wago.com/722-244/005-000">www.wago.com/722-244/005-000</a>
	<b>Nr. articol: 722-244/005-000/039-000</b> Female connector for rail-mount terminal blocks; 0.6 x 1 mm pins; angled; 100% protected against mismatching; Locking lever; Pin spacing 5 mm; 14-pole; light gray	<a href="http://www.wago.com/722-244/005-000/039-000">www.wago.com/722-244/005-000/039-000</a>
	<b>Nr. articol: 722-246/005-000</b> Female connector for rail-mount terminal blocks; 0.6 x 1 mm pins; angled; 100% protected against mismatching; Pin spacing 5 mm; 16-pole; light gray	<a href="http://www.wago.com/722-246/005-000">www.wago.com/722-246/005-000</a>
	<b>Nr. articol: 722-246/005-000/039-000</b> Female connector for rail-mount terminal blocks; 0.6 x 1 mm pins; angled; 100% protected against mismatching; Locking lever; Pin spacing 5 mm; 16-pole; light gray	<a href="http://www.wago.com/722-246/005-000/039-000">www.wago.com/722-246/005-000/039-000</a>
	<b>Nr. articol: 722-250/005-000</b>	

Supus modificărilor.



Female connector for rail-mount terminal blocks; 0.6 x 1 mm pins; angled; 100% protected against mismatching; Pin spacing 5 mm; 20-pole; light gray

[www.wago.com/722-250/005-000](http://www.wago.com/722-250/005-000)

#### Carrier rail



**Nr. articol: 210-112**

Steel carrier rail; 35 x 7.5 mm; 1 mm thick; 2 m long; slotted; according to EN 60715; "Hole width 25 mm

[www.wago.com/210-112](http://www.wago.com/210-112)

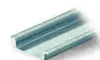

**Nr. articol: 210-113**

Steel carrier rail; 35 x 7.5 mm; 1 mm thick; 2 m long; unslotted; according to EN 60715

[www.wago.com/210-113](http://www.wago.com/210-113)



**Nr. articol: 210-114**

Steel carrier rail; 35 x 15 mm; 1.5 mm thick; 2 m long; unslotted; similar to EN 60715

[www.wago.com/210-114](http://www.wago.com/210-114)



**Nr. articol: 210-115**

Steel carrier rail; 35 x 7.5 mm; 1 mm thick; 2 m long; slotted; according to EN 60715; "Hole width 18 mm

[www.wago.com/210-115](http://www.wago.com/210-115)

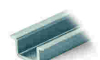

**Nr. articol: 210-118**

Steel carrier rail; 35 x 15 mm; 2.3 mm thick; 2 m long; unslotted; according to EN 60715

[www.wago.com/210-118](http://www.wago.com/210-118)



**Nr. articol: 210-196**

Aluminum carrier rail; 35 x 8.2 mm; 1.6 mm thick; 2 m long; unslotted; similar to EN 60715; silver-colored

[www.wago.com/210-196](http://www.wago.com/210-196)

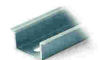

**Nr. articol: 210-197**

Steel carrier rail; 35 x 15 mm; 1.5 mm thick; 2 m long; slotted; similar to EN 60715

[www.wago.com/210-197](http://www.wago.com/210-197)



**Nr. articol: 210-198**

Copper carrier rail; 35 x 15 mm; 2.3 mm thick; 2 m long; unslotted; according to EN 60715; copper-colored

[www.wago.com/210-198](http://www.wago.com/210-198)



**Nr. articol: 210-504**

Steel carrier rail; 35 x 7.5 mm; 1 mm thick; 2 m long; slotted; galvanized; according to EN 60715

[www.wago.com/210-504](http://www.wago.com/210-504)

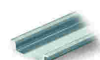

**Nr. articol: 210-505**

Steel carrier rail; 35 x 7.5 mm; 1 mm thick; 2 m long; unslotted; galvanized; according to EN 60715

[www.wago.com/210-505](http://www.wago.com/210-505)



**Nr. articol: 210-506**

Steel carrier rail; 35 x 15 mm; 1.5 mm thick; 2 m long; unslotted; galvanized; similar to EN 60715

[www.wago.com/210-506](http://www.wago.com/210-506)



**Nr. articol: 210-508**

Steel carrier rail; 35 x 15 mm; 1.5 mm thick; 2 m long; slotted; galvanized; similar to EN 60715

[www.wago.com/210-508](http://www.wago.com/210-508)

#### Protective Warning Marker



**Nr. articol: 280-415**

Protective warning marker; with high-voltage symbol, black; for 5 terminal blocks; yellow

[www.wago.com/280-415](http://www.wago.com/280-415)

#### ferrule



**Nr. articol: 216-101**

Ferrule; Sleeve for 0.5 mm<sup>2</sup> / AWG 22; uninsulated; electro-tin plated

[www.wago.com/216-101](http://www.wago.com/216-101)



















**Nr. articol: 216-102**

Ferrule; Sleeve for 0.75 mm<sup>2</sup> / AWG 20; uninsulated; electro-tin plated

[www.wago.com/216-102](http://www.wago.com/216-102)

Supus modificărilor.

	<b>Nr. articol: 216-103</b> Ferrule; Sleeve for 1 mm <sup>2</sup> / AWG 18; uninsulated; electro-tin plated	<a href="http://www.wago.com/216-103">www.wago.com/216-103</a>
	<b>Nr. articol: 216-104</b> Ferrule; Sleeve for 1.5 mm <sup>2</sup> / AWG 16; uninsulated; electro-tin plated	<a href="http://www.wago.com/216-104">www.wago.com/216-104</a>
	<b>Nr. articol: 216-201</b> Ferrule; Sleeve for 0.5 mm <sup>2</sup> / 20 AWG; insulated; electro-tin plated; white	<a href="http://www.wago.com/216-201">www.wago.com/216-201</a>
	<b>Nr. articol: 216-202</b> Ferrule; Sleeve for 0.75 mm <sup>2</sup> / 18 AWG; insulated; electro-tin plated; gray	<a href="http://www.wago.com/216-202">www.wago.com/216-202</a>
	<b>Nr. articol: 216-203</b> Ferrule; Sleeve for 1 mm <sup>2</sup> / AWG 18; insulated; electro-tin plated; red	<a href="http://www.wago.com/216-203">www.wago.com/216-203</a>
	<b>Nr. articol: 216-204</b> Ferrule; Sleeve for 1.5 mm <sup>2</sup> / AWG 16; insulated; electro-tin plated; black	<a href="http://www.wago.com/216-204">www.wago.com/216-204</a>
	<b>Nr. articol: 216-301</b> Ferrule; Sleeve for 0.25 mm <sup>2</sup> / AWG 24; insulated; electro-tin plated; yellow	<a href="http://www.wago.com/216-301">www.wago.com/216-301</a>
	<b>Nr. articol: 216-302</b> Ferrule; Sleeve for 0.34 mm <sup>2</sup> / 22 AWG; insulated; electro-tin plated; green	<a href="http://www.wago.com/216-302">www.wago.com/216-302</a>
<b>check</b>		
	<b>Nr. articol: 210-136</b> Test plug; 2 mm Ø; with 500 mm cable; red	<a href="http://www.wago.com/210-136">www.wago.com/210-136</a>
	<b>Nr. articol: 210-137</b> Test plug; 2.3 mm Ø; with 500 mm cable; yellow	<a href="http://www.wago.com/210-137">www.wago.com/210-137</a>
	<b>Nr. articol: 249-141</b> L-type test plug module; modular; with spring-loaded contact pin; Center module; 1,50 mm <sup>2</sup> ; gray	<a href="http://www.wago.com/249-141">www.wago.com/249-141</a>
<b>End plate</b>		
	<b>Nr. articol: 280-314</b> End and intermediate plate; 2.5 mm thick; gray	<a href="http://www.wago.com/280-314">www.wago.com/280-314</a>
	<b>Nr. articol: 280-315</b> End and intermediate plate; 2.5 mm thick; orange	<a href="http://www.wago.com/280-315">www.wago.com/280-315</a>
	<b>Nr. articol: 280-334</b> Separator plate; 2 mm thick; oversized; gray	<a href="http://www.wago.com/280-334">www.wago.com/280-334</a>
	<b>Nr. articol: 280-335</b> Separator plate; 2 mm thick; oversized; orange	<a href="http://www.wago.com/280-335">www.wago.com/280-335</a>
<b>Insulation stop</b>		
	<b>Nr. articol: 280-470</b> Insulation stop; 0.08 - 0.2 mm <sup>2</sup> "s" (0.14 mm <sup>2</sup> "f-st"); 5 pieces/strip; white	<a href="http://www.wago.com/280-470">www.wago.com/280-470</a>
	<b>Nr. articol: 280-471</b> Insulation stop; 0.25 - 0.5 mm <sup>2</sup> ; 5 pieces/strip; light gray	<a href="http://www.wago.com/280-471">www.wago.com/280-471</a>

Supus modificărilor.



Nr. articol: 280-472

Insulation stop; 0.75 - 1 mm<sup>2</sup>; 5 pieces/strip

[www.wago.com/280-472](http://www.wago.com/280-472)

## Descărcări Documentation

### Additional Information

Technical explanations

Apr 3, 2019

pdf  
2,1 MB

Descărcare

## CAD/CAE-Data

### CAD data

2D/3D Models 280-649

URL

Descărcare

### CAE data

EPLAN Data Portal 280-649

URL

Descărcare

WSCAD Universe 280-649

URL

Descărcare

## Installation Notes

### Safety

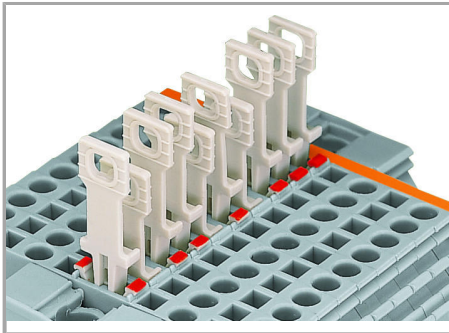

Disconnect terminal block with colored tab to indicate the switching status (red = disconnected)

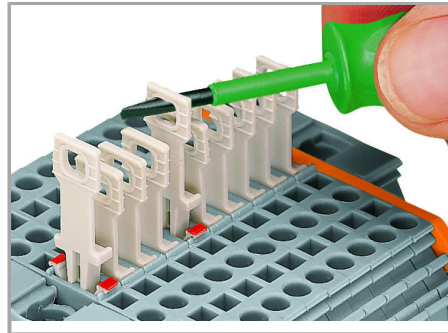

Pulling the disconnect tab via operating tool.

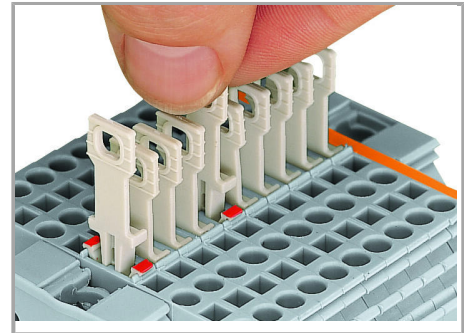

Pulling the disconnect tab by hand.

Supus modificărilor.

WAGO Kontakttechnik GmbH & Co. KG  
/Representative Office Romania  
Sos. Pipera-Tunari nr. 1/1  
building 1, 2nd floor | 077190 Voluntari, Ilfov  
Tel.: +40-(0)31 421 85 68 | Email: [info-RO@wago.com](mailto:info-RO@wago.com)

Aveți întrebări despre produsele noastre?  
Vă stăm la dispoziție pentru preluarea apelului la +40 (0) 31 421 85 68.