

Fișă tehnică | Număr articol: 771-9393/3267-801

pre-assembled connecting cable; Cca; Plug/open-ended; 3-pole; Cod. A; 8 m; 2,50 mm²; black

www.wago.com/771-9393/3267-801

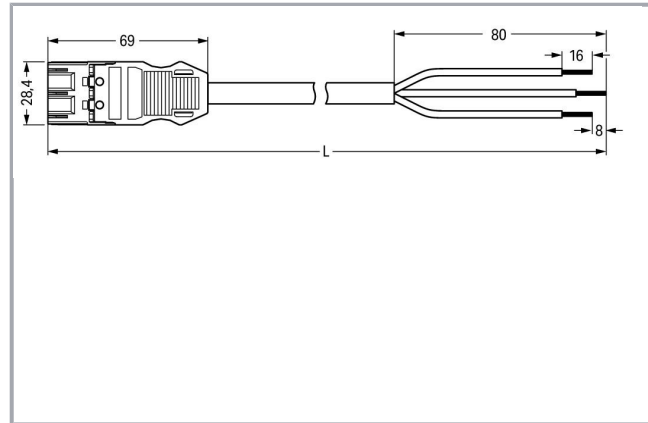
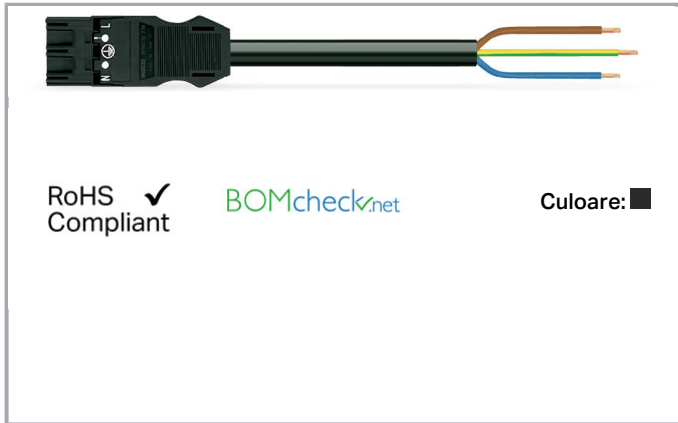

Descriere articol

- Protected against mismatching and maintenance-free
- Additional variable coding is possible

Note:

Cables with a different fire class can be found in the eShop.

Note on mismatching protection:

All WINSTA[®] components are 100% protected against mismatching when:

- plugging different numbers of poles
- plugging while rotated 180
- plugging while laterally staggered
- plugging one pole

Safety information 1:

Application note for the U.S. market (USR): Some versions may also be used for current interruption in accordance with the UL certificate in select applications with currents below 16 A and voltages up to 600 V. For further information, please contact your local sales office.

Date

Electrical data

Note on Contact Resistance

approx. 1 mΩ of contact resistance approx. 0.25 mΩ contact transition plug/socket

Supus modificărilor.

WAGO Kontakttechnik GmbH & Co. KG
/Representative Office Romania
Sos. Pipera-Tunari nr. 1/1
building 1, 2nd floor | 077190 Voluntari, Ilfov
Tel.: +40-(0)31 421 85 68 | Email: info-RO@wago.com

Aveți întrebări despre produsele noastre?
Vă stăm la dispoziție pentru preluarea apelului la +40 (0) 31 421 85 68.



Ratings per IEC/EN 60664-1

Ratings per	IEC/EN 60664-1
Nominal voltage (III/3)	250 V
Rated surge voltage (III/3)	4 kV
Rated current	20 A
Legend (ratings)	(III / 3) ≙ Overvoltage category III / Pollution degree 3

Approvals per UL 1977

Rated voltage UL 1977	600 V
Rated current UL 1977	23 A

Connection data

Pole No.	3
Total number of potentials	3
Ground function	with preceding ground contact
Conductor preparation	tip-bonded
Sheathed cable diameter	9,2 ... 11,4 mm
Wire cross-section	2,5 mm ²
Strip length (outer insulation)	80 mm

Geometrical Data

Pin spacing	10 mm / 0.394 inch
Total length	8 m

Mechanical data

Coding	A
Mating force of a plug-in connection	approx. 20 ... 70 N (depending on pole number)
Retention force of a plug-in connection	when locked: > 80N
Unmating force of a plug-in connection	when unlocked: approx. 20 ... 70 N (depending on pole number)
Number of mating cycles	200 (without resistive load) 100 (with resistive load $I_N = 25$ A), tested (4 mm ²)
Type of pre-assembled cable	Connecting cable
Cable type	H05Z1Z1-F 3G2.5
Marking	L N
Protection type	IP20
Note on protection type	Only when mated (these compact connectors are not designed for

Supus modificărilor.



use in open, easily accessible areas).

Potential marking	L N
Application	General mains applications

Plug connection

Mismatching protection	Yes
Locking of plug-in connection	locking lever
Locking lever	retrofitable

Material Data

Color	black
Insulation material	Polyamide 66 (PA 66)
Fire class per EN 50575	C _{ca}
Contact material	Copper or copper alloy (surface-treated)
Connector color	black
Printing color of mating face	white
Strain relief color	black
Printing color of strain relief	white
Sheathed cable color	black
Printing color of sheathed cable	white
Halogen-free	Yes
Weight	1280,8 g

Environmental Requirements

Processing temperature	-5 ... +40 °C
Continuous operating temperature	-35 ... +85 °C
Note on continuous operating temperature	PVC cable for temperatures ≤ 70 °C (including halogen-free) Insulating parts for temperatures ≤ 105 °C

Commercial data

Packaging type	not packed
Country of origin	DE
GTIN	4055143779357
Customs tariff number	85444290900

Counterpart







Supus modificărilor.

WAGO Kontakttechnik GmbH & Co. KG
/Representative Office Romania
Sos. Pipera-Tunari nr. 1/1
building 1, 2nd floor | 077190 Voluntari, Ilfov
Tel.: +40-(0)31 421 85 68 | Email: info-RO@wago.com

Aveți întrebări despre produsele noastre?
Vă stăm la dispoziție pentru preluarea apelului la +40 (0) 31 421 85 68.

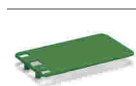
Produse compatibile

Marking accessories

	Nr. articol: 210-334 Marking strips; as a DIN A4 sheet; Strip width 5 mm; Strip length 182 mm; plain; Self-adhesive; white	www.wago.com/210-334
	Nr. articol: 770-450 Marker card; Plastic; white	www.wago.com/770-450
	Nr. articol: 770-450/000-001 Marker card; Plastic; white	www.wago.com/770-450/000-001
	Nr. articol: 770-450/000-002 Marker card; Plastic; white	www.wago.com/770-450/000-002
	Nr. articol: 770-450/000-005 Marker card; Plastic; white	www.wago.com/770-450/000-005
	Nr. articol: 770-450/000-006 Marker card; Plastic; white	www.wago.com/770-450/000-006
	Nr. articol: 770-450/000-012 Marker card; Plastic; white	www.wago.com/770-450/000-012

Installation Notes

Familie de produse

<i>WINSTA</i>® MIDI
Afișare globală produse din familie.

Supus modificărilor.

WAGO Kontakttechnik GmbH & Co. KG
/Representative Office Romania
Sos. Pipera-Tunari nr. 1/1
building 1, 2nd floor | 077190 Voluntari, Ilfov
Tel.: +40-(0)31 421 85 68 | Email: info-RO@wago.com

Aveți întrebări despre produsele noastre?
Vă stăm la dispoziție pentru preluarea apelului la +40 (0) 31 421 85 68.