

## Fișă tehnică | Număr articol: 770-967

T-distribution connector; 3-pole; Cod. B; 1 input; 2 outputs; 2 locking levers;  
gray

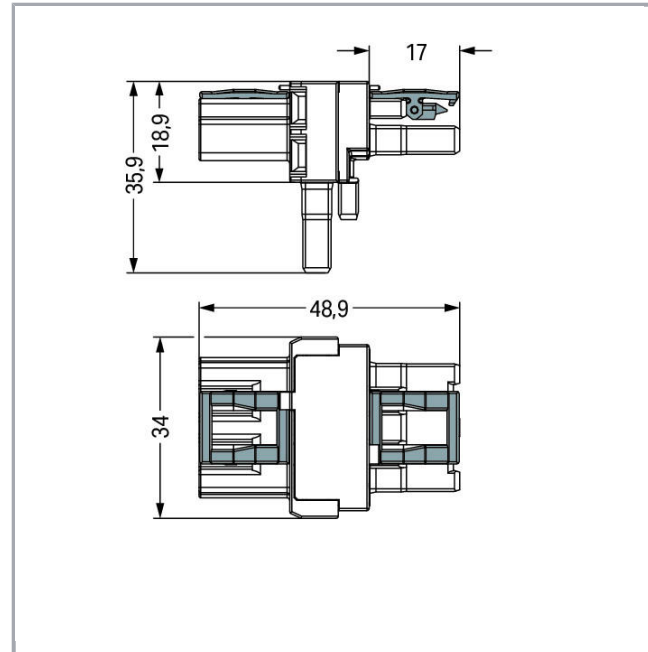

[www.wago.com/770-967](http://www.wago.com/770-967)

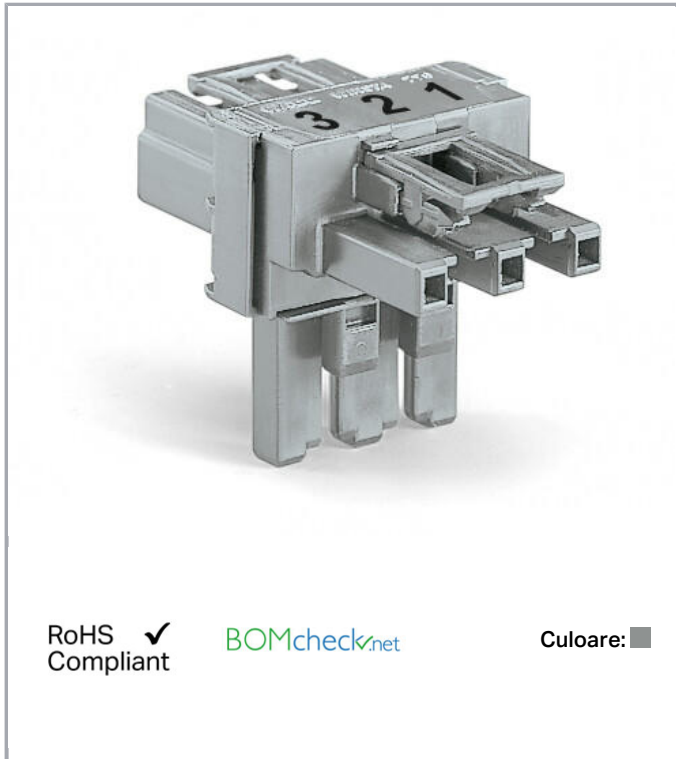

### Descriere articol

- Protected against mismatching and maintenance-free
- Additional variable coding is possible
- Components can be clearly printed on and color-coded to meet custom requirements

#### Note:

All connectors for mounted installations (snap-in versions for lighting fixtures or devices, all types of PCB and distribution connectors) are factory-equipped with locking levers to ensure plugs and sockets are securely locked. Additional locking levers are only required for flying leads (plug /socket).

#### Note on mismatching protection:

All WINSTA<sup>®</sup> components are 100% protected against mismatching when:

- plugging different numbers of poles
- plugging while rotated 180
- plugging while laterally staggered
- plugging one pole

#### Safety information 1:

Supus modificărilor.

WAGO Kontakttechnik GmbH & Co. KG  
/Representative Office Romania  
Sos. Pipera-Tunari nr. 1/1  
building 1, 2nd floor | 077190 Voluntari, Ilfov  
Tel.: +40-(0)31 421 85 68 | Email: info-RO@wago.com

Aveți întrebări despre produsele noastre?

Vă stăm la dispoziție pentru preluarea apelului la +40 (0) 31 421 85 68.



Application note for the U.S. market (USR): Some versions may also be used for current interruption in accordance with the UL certificate in select applications with currents below 16 A and voltages up to 600 V. For further information, please contact your local sales office.

## Date

### Electrical data

Note on Contact Resistance	approx. 1 mΩ of contact resistance approx. 0.25 mΩ contact transition plug/socket
----------------------------	-----------------------------------------------------------------------------------

### Ratings per IEC/EN 60664-1

Ratings per	IEC/EN 60664-1
Nominal voltage (III/3)	250 V
Rated surge voltage (III/3)	4 kV
Rated current	25 A
Legend (ratings)	(III / 3) ≙ Overvoltage category III / Pollution degree 3

### Approvals per UL 1977

Rated voltage UL 1977	600 V
Rated current UL 1977	23 A

### Connection data

Pole No.	3
Total number of potentials	3

### Geometrical Data

Pin spacing	10 mm / 0.394 inch
Width	34 mm / 1.339 inch
Height	36,1 mm / 1.421 inch
Depth	48,9 mm / 1.925 inch

### Mechanical data

Coding	B
Mating force of a plug-in connection	approx. 20 ... 70 N (depending on pole number)
Retention force of a plug-in connection	When locked: > 80 N
Unmating force of a plug-in connection	when unlocked: approx. 20 ... 70 N (depending on pole number)
Number of mating cycles	200, without resistive load 100, with resistive load $I_N = 25$ A, tested (4 mm <sup>2</sup> /AWG 12)

Supus modificărilor.

WAGO Kontakttechnik GmbH & Co. KG  
 /Representative Office Romania  
 Sos. Pipera-Tunari nr. 1/1  
 building 1, 2nd floor | 077190 Voluntari, Ilfov  
 Tel.: +40-(0)31 421 85 68 | Email: info-RO@wago.com

Aveți întrebări despre produsele noastre?  
 Vă stăm la dispoziție pentru preluarea apelului la +40 (0) 31 421 85 68.



Distributor type	T-distribution connector
Marking	1 2 3
Protection type	IP20
Note on protection type	Only when mated (these compact connectors are not designed for use in open, easily accessible areas).
Potential marking	1 2 3

### Plug connection

Contact type (pluggable connector)	Socket/plug
Mismating protection	Yes
Locking of plug-in connection	locking lever
Locking lever	yes

### Material Data

Color	gray
Insulation material	Polyamide 66 (PA 66)
Contact material	Copper or copper alloy (surface-treated)
Fire load	0,319 MJ
Weight	16,1 g

### Environmental Requirements

Processing temperature	-5 ... +40 °C
Continuous operating temperature	-35 ... +85 °C
Note on continuous operating temperature	Insulating parts for temperatures ≤ 105 °C

### Commercial data

Product Group	20 (WINSTA)
Packaging type	BOX
Country of origin	DE
GTIN	4045454475864
Customs tariff number	85366990990

### Aprobări / certificate

#### Country specific Approvals



Emblemă	Aprobare	Text de aprobare suplimentar	Nume certificat
	CCA	EN 61984	2173495.01

Supus modificărilor.



DEKRA Certification B.V.





## Ship Approvals

Embleă	Aprobare	Text de aprobare suplimentar	Nume certificat
	<b>ABS</b> American Bureau of Shipping	-	19- HG1868589- PDA
	<b>DNV GL</b> Det Norske Veritas, Germanischer Lloyd	-	TAE00001Z6
	<b>LR</b> Lloyds Register	IEC 61984	02/20050 (E6)

## UL-Approvals

Embleă	Aprobare	Text de aprobare suplimentar	Nume certificat
	<b>cURus</b> Underwriters Laboratories Inc.	UL 1977	E45171 Sec. 9
	<b>cURus</b> Underwriters Laboratories Inc.	UL 1059	20190731- E45172

## Counterpart

	<b>Nr. articol770-243</b> Socket; 3-pole; Cod. B; 4,00 mm <sup>2</sup> ; gray	<a href="http://www.wago.com/770-243">www.wago.com/770-243</a>
	<b>Nr. articol770-253</b> Plug; 3-pole; Cod. B; 4,00 mm <sup>2</sup> ; gray	<a href="http://www.wago.com/770-253">www.wago.com/770-253</a>
	<b>Nr. articol771-9993/005-103</b> pre-assembled interconnecting cable; Eca; Socket/plug; 3-pole; Cod. B; H05VV-F 3 x 1.0 mm <sup>2</sup> ; 1 m; 1,00 mm <sup>2</sup> ; gray	<a href="http://www.wago.com/771-9993/005-103">www.wago.com/771-9993/005-103</a>

Supus modificărilor.

WAGO Kontakttechnik GmbH & Co. KG  
/Representative Office Romania  
Sos. Pipera-Tunari nr. 1/1  
building 1, 2nd floor | 077190 Voluntari, Ilfov  
Tel.: +40-(0)31 421 85 68 | Email: info-RO@wago.com

Aveți întrebări despre produsele noastre?  
Vă stăm la dispoziție pentru preluarea apelului la +40 (0) 31 421 85 68.

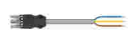

Nr. articol 771-9993/105-103

pre-assembled connecting cable; Eca; Socket/open-ended; 3-pole; Cod. B; H05VV-F 3 x 1.0 mm<sup>2</sup>; 1 m; 1,00 mm<sup>2</sup>; gray

[www.wago.com/771-9993/105-103](http://www.wago.com/771-9993/105-103)



Nr. articol 771-9993/205-103

pre-assembled connecting cable; Eca; Plug/open-ended; 3-pole; Cod. B; H05VV-F 3 x 1.0 mm<sup>2</sup>; 1 m; 1,00 mm<sup>2</sup>; gray

[www.wago.com/771-9993/205-103](http://www.wago.com/771-9993/205-103)

## Descărcări

### CAD/CAE-Data

#### CAE data

EPLAN Data Portal 770-967

URL

Descărcare

WSCAD Universe 770-967

URL

Descărcare

## Installation Notes

### Installation

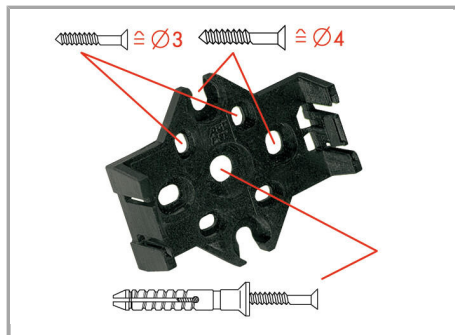

The mounting plate for distribution connectors can be mounted using commercially available screws or nail-drive anchors.



The distribution connectors are latched when mounted on the mounting plate.



To release the distribution connector, unlock the latch using a screwdriver.

Supus modificărilor.

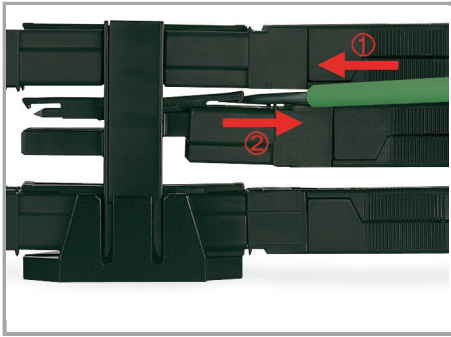

All distributor connections are locked and protected against accidental disconnection directly after mating. Locking of any connection is released using a screwdriver, even if all connections are in use.

## Familie de produse

*WINSTA*® MIDI special

Afișare globală produse din familie.

Supus modificărilor.