

Fișă tehnică | Număr articol: 770-1715

3-way distribution connector; 3-pole; Cod. B; 1 input; 3 outputs; light green

www.wago.com/770-1715

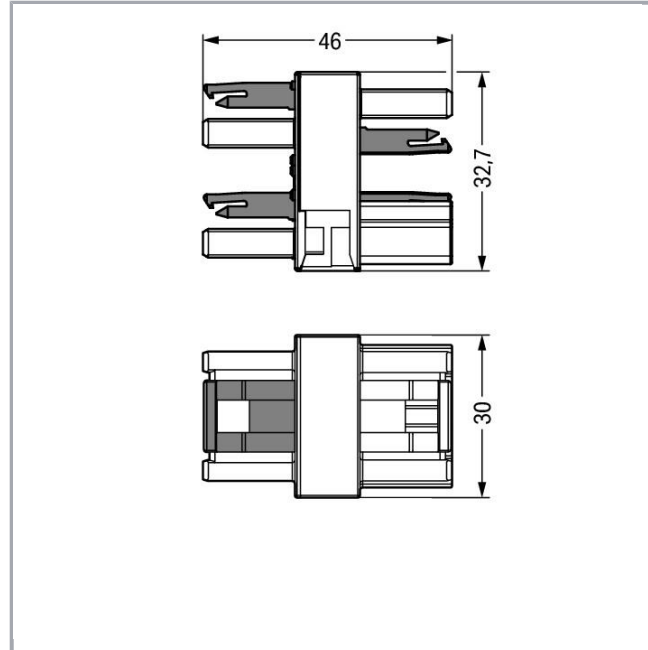
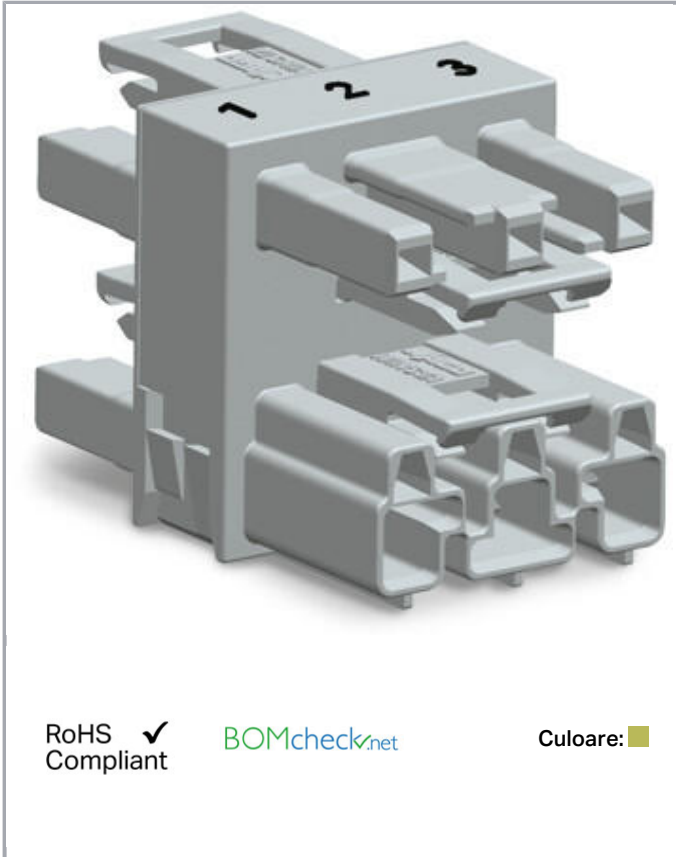

Descriere articol

- Protected against mismatching and maintenance-free
- Additional variable coding is possible
- Components can be clearly printed on and color-coded to meet custom requirements

Note:

All connectors for mounted installations (snap-in versions for lighting fixtures or devices, all types of PCB and distribution connectors) are factory-equipped with locking levers to ensure plugs and sockets are securely locked. Additional locking levers are only required for flying leads (plug /socket).

Note on mismatching protection:

All WINSTA[®] components are 100% protected against mismatching when:

- a.) plugging different numbers of poles
- b.) plugging while rotated 180

Supus modificărilor.

WAGO Kontakttechnik GmbH & Co. KG
/Representative Office Romania
Sos. Pipera-Tunari nr. 1/1
building 1, 2nd floor | 077190 Voluntari, Ilfov
Tel.: +40-(0)31 421 85 68 | Email: info-RO@wago.com

Aveți întrebări despre produsele noastre?
Vă stăm la dispoziție pentru preluarea apelului la +40 (0) 31 421 85 68.



c.) plugging while laterally staggered

d.) plugging one pole

Safety information 1:

Application note for the U.S. market (USR): Some versions may also be used for current interruption in accordance with the UL certificate in select applications with currents below 16 A and voltages up to 600 V. For further information, please contact your local sales office.

Date**Electrical data**

Note on Contact Resistance	approx. 1 mΩ of contact resistance approx. 0.25 mΩ contact transition plug/socket
----------------------------	---

Ratings per IEC/EN 60664-1

Ratings per	IEC/EN 60664-1
Nominal voltage (III/3)	250 V
Rated surge voltage (III/3)	4 kV
Rated current	25 A
Legend (ratings)	(III / 3) ≙ Overvoltage category III / Pollution degree 3

Approvals per UL 1977

Rated voltage UL 1977	600 V
Rated current UL 1977	23 A

Connection data

Pole No.	3
Total number of potentials	3

Geometrical Data

Pin spacing	10 mm / 0.394 inch
Width	30 mm / 1.181 inch
Height	32,7 mm / 1.287 inch
Depth	46 mm / 1.811 inch

Mechanical data

Coding	B
Mating force of a plug-in connection	approx. 20 ... 70 N (depending on pole number)
Retention force of a plug-in connection	When locked: > 80 N
Unmating force of a plug-in connection	when unlocked: approx. 20 ... 70 N (depending on pole number)

Supus modificărilor.

WAGO Kontakttechnik GmbH & Co. KG
 /Representative Office Romania
 Sos. Pipera-Tunari nr. 1/1
 building 1, 2nd floor | 077190 Voluntari, Ilfov
 Tel.: +40-(0)31 421 85 68 | Email: info-RO@wago.com

Aveți întrebări despre produsele noastre?
 Vă stăm la dispoziție pentru preluarea apelului la +40 (0) 31 421 85 68.



Number of mating cycles	200, without resistive load 100, with resistive load $I_N = 25$ A, tested (4 mm ² /AWG 12)
Distributor type	Distribution connector, 3-way,
Marking	1 2 3
Protection type	IP20
Note on protection type	Only when mated (these compact connectors are not designed for use in open, easily accessible areas).
Potential marking	1 2 3

Plug connection

Contact type (pluggable connector)	Socket/plug
Mismating protection	Yes
Locking of plug-in connection	locking lever
Locking lever	yes

Material Data

Color	light green
Insulation material	Polyamide 66 (PA 66)
Contact material	Copper or copper alloy (surface-treated)
Fire load	0,466 MJ
Weight	26,8 g

Environmental Requirements

Processing temperature	-5 ... +40 °C
Continuous operating temperature	-35 ... +85 °C
Note on continuous operating temperature	Insulating parts for temperatures ≤ 105 °C

Commercial data

Product Group	20 (WINSTA)
Packaging type	BOX
Country of origin	DE
GTIN	4050821687665
Customs tariff number	85366990990

Aprobări / certificate

UL-Approvals



Supus modificărilor.

WAGO Kontakttechnik GmbH & Co. KG
 /Representative Office Romania
 Sos. Pipera-Tunari nr. 1/1
 building 1, 2nd floor | 077190 Voluntari, Ilfov
 Tel.: +40-(0)31 421 85 68 | Email: info-RO@wago.com

Aveți întrebări despre produsele noastre?
 Vă stăm la dispoziție pentru preluarea apelului la +40 (0) 31 421 85 68.

Emblemă	Aprobare	Text de aprobare suplimentar	Nume certificat
	cURus Underwriters Laboratories Inc.	UL 1977	E45171 Sec. 9

Counterpart

	Nr. articol 770-263 Socket; 3-pole; Cod. B; 4,00 mm ² ; light green	www.wago.com/770-263
	Nr. articol 770-273 Plug; 3-pole; Cod. B; 4,00 mm ² ; light green	www.wago.com/770-273
	Nr. articol 771-9993/005-105 pre-assembled interconnecting cable; Eca; Socket/plug; 3-pole; Cod. B; H05VV-F 3 x 1.0 mm ² ; 1 m; 1,00 mm ² ; light green	www.wago.com/771-9993/005-105
	Nr. articol 771-9993/205-105 pre-assembled connecting cable; Eca; Plug/open-ended; 3-pole; Cod. B; H05VV-F 3 x 1.0 mm ² ; 1 m; 1,00 mm ² ; light green	www.wago.com/771-9993/205-105
	Nr. articol 771-9993/105-105 pre-assembled connecting cable; Eca; Socket/open-ended; 3-pole; Cod. B; H05VV-F 3 x 1.0 mm ² ; 1 m; 1,00 mm ² ; light green	www.wago.com/771-9993/105-105

Descărcări

CAD/CAE-Data

CAE data

WSCAD Universe 770-1715	URL	Descărcare

Installation Notes

Installation

Supus modificărilor.

WAGO Kontakttechnik GmbH & Co. KG
/Representative Office Romania
Sos. Pipera-Tunari nr. 1/1
building 1, 2nd floor | 077190 Voluntari, Ilfov
Tel.: +40-(0)31 421 85 68 | Email: info-RO@wago.com

Aveți întrebări despre produsele noastre?
Vă stăm la dispoziție pentru preluarea apelului la +40 (0) 31 421 85 68.

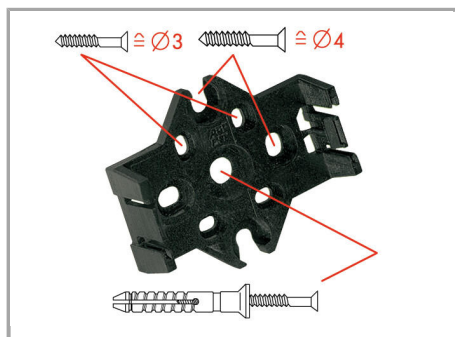

The mounting plate for distribution connectors can be mounted using commercially available screws or nail-drive anchors.



The distribution connectors are latched when mounted on the mounting plate.



To release the distribution connector, unlock the latch using a screwdriver.

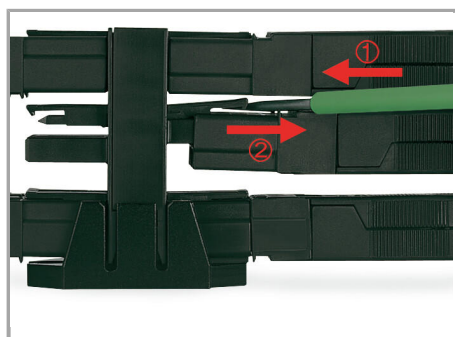

All distributor connections are locked and protected against accidental disconnection directly after mating. Locking of any connection is released using a screwdriver, even if all connections are in use.

Familie de produse

<i>WINSTA</i>® MIDI special

Afișare globală produse din familie.

Supus modificărilor.