

Fișă tehnică | Număr articol: 727-132/001-000

8-level terminal block for matrix patching; for 35 x 15 mounting rail; 1,50 mm²; white

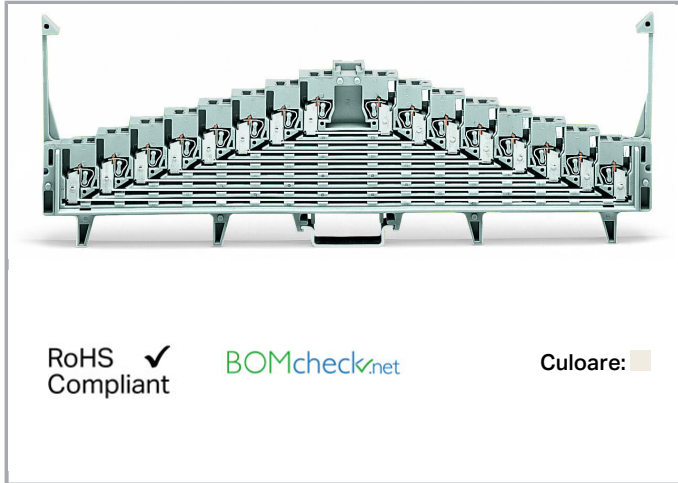

www.wago.com/727-132/001-000



Date

Electrical data

Ratings per IEC/EN 60664-1

Nominal voltage (III/3)	250 V
Rated surge voltage (III/3)	4 kV
Rated current	10 A
Legend (ratings)	(III / 3) ≙ Overvoltage category III / Pollution degree 3

Connection data

Connection technology	CAGE CLAMP®
Actuation type	Operating tool
Connectable conductor materials	Copper
Solid conductor	0.08 ... 1.5 mm ² / 28 ... 16 AWG
Fine-stranded conductor	0.08 ... 1.5 mm ² / 28 ... 16 AWG
Strip length	8 ... 10 mm / 0.31 ... 0.39 inch
Total number of connection points	32
Total number of potentials	8
Number of levels	8
Wiring type	Front-entry wiring

Supus modificărilor.

WAGO Kontakttechnik GmbH & Co. KG
/Representative Office Romania
Sos. Pipera-Tunari nr. 1/1
building 1, 2nd floor | 077190 Voluntari, Ilfov
Tel.: +40-(0)31 421 85 68 | Email: info-RO@wago.com

Aveți întrebări despre produsele noastre?
Vă stăm la dispoziție pentru preluarea apelului la +40 (0) 31 421 85 68.

Geometrical Data

Width	7.62 mm / 0.3 inch
Height from upper-edge of DIN-rail	58.5 mm / 2.303 inch
Depth	226 mm / 8.898 inch

Mechanical data

Design	horizontal
Mounting type	DIN-35 rail
Marking	0-1-2-3-4-5-6-7--7-6-5-4-3-2-1-0
Marking level	Center marking

Material Data



Color	white
Insulation material	Polyamide 66 (PA 66)
Fire load	1,187 MJ
Weight	74 g

Commercial data

Packaging type	BOX
Country of origin	DE
GTIN	4045454188016
Customs tariff number	85369010000

Aprobări / certificate

Country specific Approvals

Emblemă	Aprobare	Text de aprobare suplimentar	Nume certificat
	CCA DEKRA Certification B.V.	EN 60947	NTR NL 7485
	CSA DEKRA Certification B.V.	C22.2 No. 158	70048845
	KEMA/KEUR DEKRA Certification B.V.	EN 60947	2192101.01











Supus modificărilor.



Counterpart

Produse compatibile















End plate

	Nr. articol: 727-105 8-level end plate; marking: 0-1-2-3-4-5-6-7--7-6-5-4-3-2-1; 7.62 mm thick; orange	www.wago.com/727-105
	Nr. articol: 727-106 8-level end plate; marking: a-b-c-d-e-f-g-h--h-g-f-e-d-c-b-a; 7.62 mm thick; orange	www.wago.com/727-106
	Nr. articol: 727-107 8-level end plate; marking: 7-6-5-4-3-2-1-0--0-1-2-3-4-5-6-7; 7.62 mm thick; orange	www.wago.com/727-107
	Nr. articol: 727-108 8-level end plate; marking: h-g-f-e-d-c-b-a--a-b-c-d-e-f-g-h; 7.62 mm thick; orange	www.wago.com/727-108
	Nr. articol: 727-113 8-level end plate; plain; 7.62 mm thick; gray	www.wago.com/727-113
	Nr. articol: 727-114 8-level end plate; plain; 7.62 mm thick; blue	www.wago.com/727-114
	Nr. articol: 727-115 8-level end plate; plain; 7.62 mm thick; white	www.wago.com/727-115
	Nr. articol: 727-116 8-level end plate; plain; 7.62 mm thick; light gray	www.wago.com/727-116
	Nr. articol: 727-117 8-level end plate; plain; 7.62 mm thick; orange	www.wago.com/727-117
	Nr. articol: 727-155 8-level end plate; marking: 0-1-2-3-4-5-6-7--7-6-5-4-3-2-1; 7.62 mm thick; gray	www.wago.com/727-155



Supus modificărilor.

WAGO Kontakttechnik GmbH & Co. KG
/Representative Office Romania
Sos. Pipera-Tunari nr. 1/1
building 1, 2nd floor | 077190 Voluntari, Ilfov
Tel.: +40-(0)31 421 85 68 | Email: info-RO@wago.com















Aveți întrebări despre produsele noastre?
Vă stăm la dispoziție pentru preluarea apelului la +40 (0) 31 421 85 68.

	Nr. articol: 727-156 8-level end plate; marking: a-b-c-d-e-f-g-h--h-g-f-e-d-c-b-a; 7.62 mm thick; gray	www.wago.com/727-156
	Nr. articol: 727-157 8-level end plate; marking: 7-6-5-4-3-2-1-0--0-1-2-3-4-5-6-7; 7.62 mm thick; gray	www.wago.com/727-157
	Nr. articol: 727-158 8-level end plate; marking: h-g-f-e-d-c-b-a--a-b-c-d-e-f-g-h; 7.62 mm thick; gray	www.wago.com/727-158
	Nr. articol: 727-159 8-level end plate; marking: 0-1-2-3-4-5-6-7--7-6-5-4-3-2-1; 7.62 mm thick; blue	www.wago.com/727-159
	Nr. articol: 727-160 8-level end plate; marking: a-b-c-d-e-f-g-h--h-g-f-e-d-c-b-a; 7.62 mm thick; blue	www.wago.com/727-160
	Nr. articol: 727-161 8-level end plate; marking: 7-6-5-4-3-2-1-0--0-1-2-3-4-5-6-7; 7.62 mm thick; blue	www.wago.com/727-161
	Nr. articol: 727-162 8-level end plate; marking: h-g-f-e-d-c-b-a--a-b-c-d-e-f-g-h; 7.62 mm thick; blue	www.wago.com/727-162
	Nr. articol: 727-163 8-level end plate; marking: 0-1-2-3-4-5-6-7--7-6-5-4-3-2-1; 7.62 mm thick; white	www.wago.com/727-163
	Nr. articol: 727-164 8-level end plate; marking: a-b-c-d-e-f-g-h--h-g-f-e-d-c-b-a; 7.62 mm thick; white	www.wago.com/727-164
	Nr. articol: 727-165 8-level end plate; marking: 7-6-5-4-3-2-1-0--0-1-2-3-4-5-6-7; 7.62 mm thick; white	www.wago.com/727-165
	Nr. articol: 727-166 8-level end plate; marking: h-g-f-e-d-c-b-a--a-b-c-d-e-f-g-h; 7.62 mm thick; white	www.wago.com/727-166
	Nr. articol: 727-167 8-level end plate; marking: 0-1-2-3-4-5-6-7--7-6-5-4-3-2-1; 7.62 mm thick; light gray	www.wago.com/727-167
	Nr. articol: 727-168 8-level end plate; marking: a-b-c-d-e-f-g-h--h-g-f-e-d-c-b-a; 7.62 mm thick; light gray	www.wago.com/727-168
	Nr. articol: 727-169 8-level end plate; marking: 7-6-5-4-3-2-1-0--0-1-2-3-4-5-6-7; 7.62 mm thick; light gray	www.wago.com/727-169
	Nr. articol: 727-170 8-level end plate; marking: h-g-f-e-d-c-b-a--a-b-c-d-e-f-g-h; 7.62 mm thick; light gray	www.wago.com/727-170















Carrier rail

	Nr. articol: 210-114 Steel carrier rail; 35 x 15 mm; 1.5 mm thick; 2 m long; unslotted; similar to EN 60715	www.wago.com/210-114
	Nr. articol: 210-118 Steel carrier rail; 35 x 15 mm; 2.3 mm thick; 2 m long; unslotted; according to EN 60715	www.wago.com/210-118
	Nr. articol: 210-197 Steel carrier rail; 35 x 15 mm; 1.5 mm thick; 2 m long; slotted; similar to EN 60715	www.wago.com/210-197

Supus modificărilor.

	Nr. articol: 210-198 Copper carrier rail; 35 x 15 mm; 2.3 mm thick; 2 m long; unslotted; according to EN 60715; copper-colored	www.wago.com/210-198
	Nr. articol: 210-506 Steel carrier rail; 35 x 15 mm; 1.5 mm thick; 2 m long; unslotted; galvanized; similar to EN 60715	www.wago.com/210-506
	Nr. articol: 210-508 Steel carrier rail; 35 x 15 mm; 1.5 mm thick; 2 m long; slotted; galvanized; similar to EN 60715	www.wago.com/210-508
Insulation stop		
	Nr. articol: 727-197 Insulation stop; 0.08 - 0.2 mm ² "s" (0.14 mm ² "f-st"); 8 pieces/strip; white	www.wago.com/727-197
	Nr. articol: 727-198 Insulation stop; 0.25 mm ² "s"; 0.14 - 0.25 mm ² "f-st"; 8 pieces/strip; light gray	www.wago.com/727-198
	Nr. articol: 727-199 Insulation stop; 0.25 - 0.5 mm ² "s+f-st"; 8 pieces/strip; dark gray	www.wago.com/727-199
General accessories		
	Nr. articol: 249-109 Wire harness support; gray	www.wago.com/249-109
Marking accessories		
	Nr. articol: 2009-115 WMB-Inline; for Smart Printer; 1500 pieces on roll; stretchable 5 - 5.2 mm; plain; snap-on type; white	www.wago.com/2009-115
	Nr. articol: 2009-115/000-002 WMB-Inline; for Smart Printer; 1500 pieces on roll; stretchable 5 - 5.2 mm; plain; snap-on type; yellow	www.wago.com/2009-115/000-002
	Nr. articol: 2009-115/000-006 WMB-Inline; for Smart Printer; 1500 pieces on roll; stretchable 5 - 5.2 mm; plain; snap-on type; blue	www.wago.com/2009-115/000-006
	Nr. articol: 2009-115/000-007 WMB-Inline; for Smart Printer; 1500 pieces on roll; stretchable 5 - 5.2 mm; plain; snap-on type; gray	www.wago.com/2009-115/000-007
	Nr. articol: 2009-115/000-012 WMB-Inline; for Smart Printer; 1500 pieces on roll; stretchable 5 - 5.2 mm; plain; snap-on type; orange	www.wago.com/2009-115/000-012
	Nr. articol: 2009-115/000-017 WMB-Inline; for Smart Printer; 1500 pieces on roll; stretchable 5 - 5.2 mm; plain; snap-on type; light green	www.wago.com/2009-115/000-017
	Nr. articol: 2009-115/000-023 WMB-Inline; for Smart Printer; 1500 pieces on roll; stretchable 5 - 5.2 mm; plain; snap-on type; green	www.wago.com/2009-115/000-023

Supus modificărilor.

	Nr. articol: 2009-115/000-024 WMB-Inline; for Smart Printer; 1500 pieces on roll; stretchable 5 - 5.2 mm; plain; snap-on type; violet	www.wago.com/2009-115/000-024
	Nr. articol: 209-128 Adaptor; gray	www.wago.com/209-128
	Nr. articol: 793-501 WMB marking card; as card; not stretchable; plain; snap-on type; white	www.wago.com/793-501
	Nr. articol: 793-501/000-002 WMB marking card; as card; not stretchable; plain; snap-on type; yellow	www.wago.com/793-501/000-002
	Nr. articol: 793-501/000-005 WMB marking card; as card; not stretchable; plain; snap-on type; red	www.wago.com/793-501/000-005
	Nr. articol: 793-501/000-006 WMB marking card; as card; not stretchable; plain; snap-on type; blue	www.wago.com/793-501/000-006
	Nr. articol: 793-501/000-007 WMB marking card; as card; not stretchable; plain; snap-on type; gray	www.wago.com/793-501/000-007
	Nr. articol: 793-501/000-012 WMB marking card; as card; not stretchable; plain; snap-on type; orange	www.wago.com/793-501/000-012
	Nr. articol: 793-501/000-017 WMB marking card; as card; not stretchable; plain; snap-on type; light green	www.wago.com/793-501/000-017
	Nr. articol: 793-501/000-023 WMB marking card; as card; not stretchable; plain; snap-on type; green	www.wago.com/793-501/000-023
	Nr. articol: 793-501/000-024 WMB marking card; as card; not stretchable; plain; snap-on type; violet	www.wago.com/793-501/000-024
	Nr. articol: 793-5501 WMB marking card; as card; for terminal block width 5 - 17.5 mm; stretchable 5 - 5.2 mm; plain; snap-on type; white	www.wago.com/793-5501
	Nr. articol: 793-5501/000-002 WMB marking card; as card; for terminal block width 5 - 17.5 mm; stretchable 5 - 5.2 mm; plain; snap-on type; yellow	www.wago.com/793-5501/000-002
	Nr. articol: 793-5501/000-005 WMB marking card; as card; for terminal block width 5 - 17.5 mm; stretchable 5 - 5.2 mm; plain; snap-on type; red	www.wago.com/793-5501/000-005

Supus modificărilor.

WAGO Kontakttechnik GmbH & Co. KG
/Representative Office Romania
Sos. Pipera-Tunari nr. 1/1
building 1, 2nd floor | 077190 Voluntari, Ilfov
Tel.: +40-(0)31 421 85 68 | Email: info-RO@wago.com

Aveți întrebări despre produsele noastre?
Vă stăm la dispoziție pentru preluarea apelului la +40 (0) 31 421 85 68.

**Nr. articol: 793-5501/000-006**

WMB marking card; as card; for terminal block width 5 - 17.5 mm; stretchable 5 - 5.2 mm; plain; snap-on type; blue

www.wago.com/793-5501/000-006**Nr. articol: 793-5501/000-007**

WMB marking card; as card; for terminal block width 5 - 17.5 mm; stretchable 5 - 5.2 mm; plain; snap-on type; gray

www.wago.com/793-5501/000-007**Nr. articol: 793-5501/000-012**

WMB marking card; as card; for terminal block width 5 - 17.5 mm; stretchable 5 - 5.2 mm; plain; snap-on type; orange

www.wago.com/793-5501/000-012**Nr. articol: 793-5501/000-017**

WMB marking card; as card; for terminal block width 5 - 17.5 mm; stretchable 5 - 5.2 mm; plain; snap-on type; green

www.wago.com/793-5501/000-017**Nr. articol: 793-5501/000-023**

WMB marking card; as card; for terminal block width 5 - 17.5 mm; stretchable 5 - 5.2 mm; plain; snap-on type; light green

www.wago.com/793-5501/000-023**Nr. articol: 793-5501/000-024**

WMB marking card; as card; for terminal block width 5 - 17.5 mm; stretchable 5 - 5.2 mm; plain; snap-on type; violet

www.wago.com/793-5501/000-024**Nr. articol: 793-933**

WMB marking card; as card; MARKED; E0.0, E0.1, ..., E9.6, E9.7 (1 each); not stretchable; Vertical marking; snap-on type; white

www.wago.com/793-933**tools****Nr. articol: 210-647**

Operating tool; Blade: 2.5 x 0.4 mm; with a partially insulated shaft

www.wago.com/210-647**Nr. articol: 210-719**

Operating tool; Blade: 2.5 x 0.4 mm; with a partially insulated shaft

www.wago.com/210-719**check****Nr. articol: 210-137**

















Test plug; 2.3 mm Ø; with 500 mm cable; yellow

www.wago.com/210-137**Nr. articol: 210-297**

Step-down test plug; from 4mm socket to 2mm plug; red

www.wago.com/210-297**ferrule****Nr. articol: 216-101**Ferrule; Sleeve for 0.5 mm² / AWG 22; uninsulated; electro-tin platedwww.wago.com/216-101**Nr. articol: 216-102**Ferrule; Sleeve for 0.75 mm² / AWG 20; uninsulated; electro-tin platedwww.wago.com/216-102**Nr. articol: 216-103**Ferrule; Sleeve for 1 mm² / AWG 18; uninsulated; electro-tin platedwww.wago.com/216-103**Nr. articol: 216-104**Ferrule; Sleeve for 1.5 mm² / AWG 16; uninsulated; electro-tin platedwww.wago.com/216-104

Supus modificărilor.

	Nr. articol: 216-121 Ferrule; Sleeve for 0.5 mm ² / AWG 22; uninsulated; electro-tin plated	www.wago.com/216-121
	Nr. articol: 216-122 Ferrule; Sleeve for 0.75 mm ² / AWG 20; uninsulated; electro-tin plated	www.wago.com/216-122
	Nr. articol: 216-123 Ferrule; Sleeve for 1 mm ² / AWG 18; uninsulated; electro-tin plated	www.wago.com/216-123
	Nr. articol: 216-124 Ferrule; Sleeve for 1.5 mm ² / AWG 16; uninsulated; electro-tin plated	www.wago.com/216-124
	Nr. articol: 216-131 Ferrule; Sleeve for 0.25 mm ² / AWG 24; uninsulated; electro-tin plated	www.wago.com/216-131
	Nr. articol: 216-132 Ferrule; Sleeve for 0.34 mm ² / AWG 24; uninsulated; electro-tin plated	www.wago.com/216-132
	Nr. articol: 216-151 Ferrule; Sleeve for 0.25 mm ² / AWG 24; uninsulated; electro-tin plated	www.wago.com/216-151
	Nr. articol: 216-152 Ferrule; Sleeve for 0.34 mm ² / AWG 24; uninsulated; electro-tin plated	www.wago.com/216-152
	Nr. articol: 216-201 Ferrule; Sleeve for 0.5 mm ² / 20 AWG; insulated; electro-tin plated; white	www.wago.com/216-201
	Nr. articol: 216-202 Ferrule; Sleeve for 0.75 mm ² / 18 AWG; insulated; electro-tin plated; gray	www.wago.com/216-202
	Nr. articol: 216-203 Ferrule; Sleeve for 1 mm ² / AWG 18; insulated; electro-tin plated; red	www.wago.com/216-203
	Nr. articol: 216-204 Ferrule; Sleeve for 1.5 mm ² / AWG 16; insulated; electro-tin plated; black	www.wago.com/216-204
	Nr. articol: 216-221 Ferrule; Sleeve for 0.5 mm ² / 20 AWG; insulated; electro-tin plated; white	www.wago.com/216-221
	Nr. articol: 216-222 Ferrule; Sleeve for 0.75 mm ² / 18 AWG; insulated; electro-tin plated; gray	www.wago.com/216-222
	Nr. articol: 216-223 Ferrule; Sleeve for 1 mm ² / AWG 18; insulated; electro-tin plated; red	www.wago.com/216-223
	Nr. articol: 216-224 Ferrule; Sleeve for 1.5 mm ² / AWG 16; insulated; electro-tin plated; black	www.wago.com/216-224
	Nr. articol: 216-301 Ferrule; Sleeve for 0.25 mm ² / AWG 24; insulated; electro-tin plated; yellow	www.wago.com/216-301
	Nr. articol: 216-302 Ferrule; Sleeve for 0.34 mm ² / 22 AWG; insulated; electro-tin plated; green	www.wago.com/216-302

Supus modificărilor.

WAGO Kontakttechnik GmbH & Co. KG
/Representative Office Romania
Sos. Pipera-Tunari nr. 1/1
building 1, 2nd floor | 077190 Voluntari, Ilfov
Tel.: +40-(0)31 421 85 68 | Email: info-RO@wago.com

Aveți întrebări despre produsele noastre?
Vă stăm la dispoziție pentru preluarea apelului la +40 (0) 31 421 85 68.

Nr. articol: 216-321

Ferrule; Sleeve for 0.25 mm² / AWG 24; insulated; electro-tin plated; yellow

www.wago.com/216-321



Nr. articol: 216-322

Ferrule; Sleeve for 0.34 mm² / 22 AWG; insulated; electro-tin plated; green

www.wago.com/216-322

Jumper



Nr. articol: 709-107

Wire commoning chain; insulated; 32 connections; gray

www.wago.com/709-107

Descărcări

Documentation

Additional Information

Technical explanations

Apr 3, 2019

pdf
2,1 MB

Descărcare

CAD/CAE-Data

CAD data

2D/3D Models 727-132/001-000

URL

Descărcare

CAE data

EPLAN Data Portal 727-132/001-000

URL

Descărcare

WSCAD Universe 727-132/001-000

URL

Descărcare

Installation Notes

Assembly

Supus modificărilor.

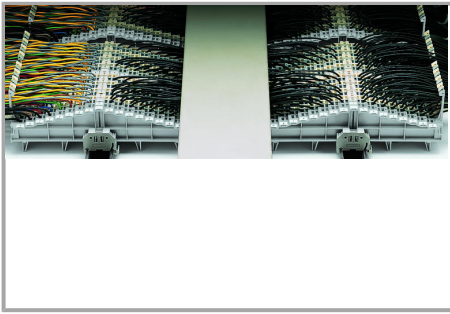

Example:

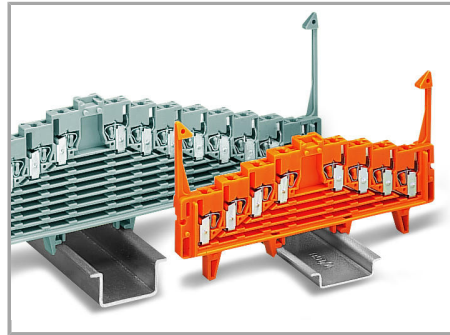

Terminal blocks for DIN 35 x 7.5 mm or DIN 35 x 15 mm rails are available.

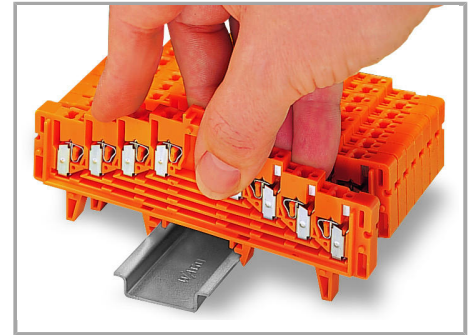

Snap individual 4- or 8-level terminal blocks onto the carrier rail.

Left: Main cables fed through locking clips on the field side

Right: Control cables fed between locking clips

Center: Wiring of both patching sides

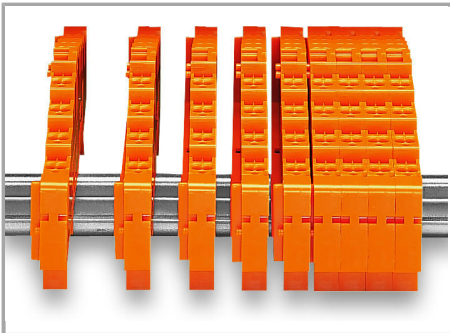

Slide terminal blocks together.

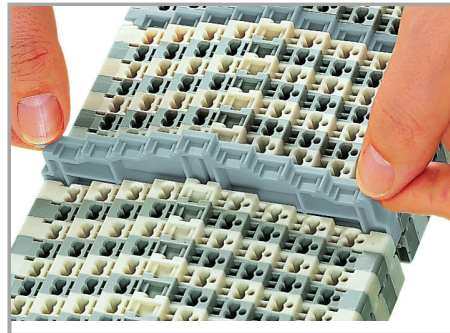

Grip end plate at both sides and:

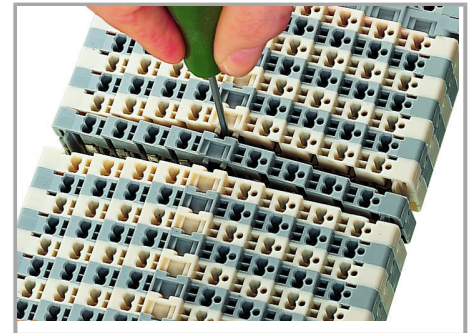

Open the assembly by laterally sliding a block via operating tool (2.5 x 0.4 mm blade).

- push down (assembly)
-
- pull up (removal)
-

Supus modificărilor.

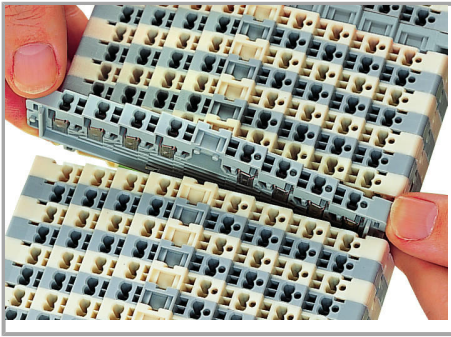

Slide terminal block and remove from the rail with a levering action.

Inserting a conductor

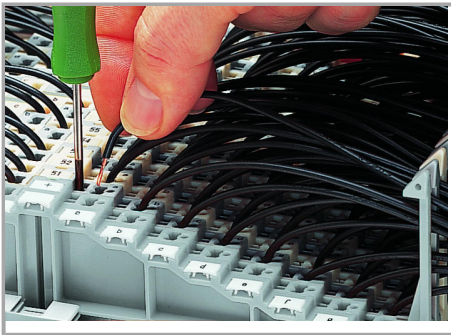

CAGE CLAMP® connection

Inserting a conductor via 210-719 Operating Tool (2.5 x 0.4 mm blade).

Max. cross section for uninsulated ferrules
1 mm² / 18 AWG, for insulated ferrules
0.75 mm² / 20 AWG.

Testing

Supus modificărilor.

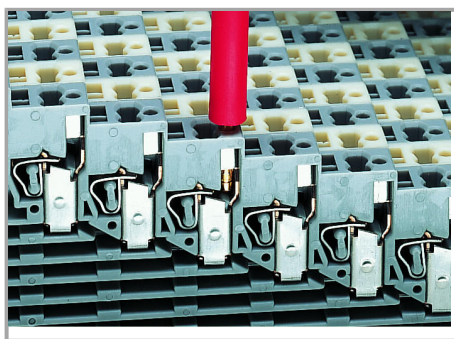

Special test contact for 2.3 mm Ø test plug.

Ex Application

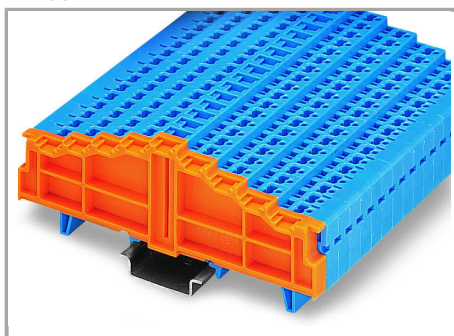

Blue terminal blocks for matrix patching are suitable for Ex i applications.

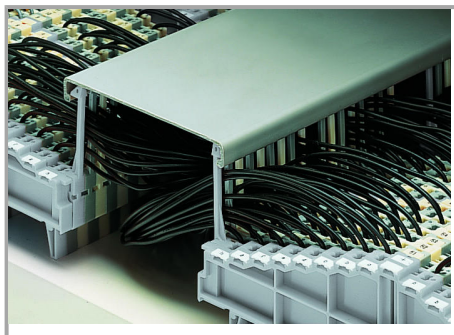

Using terminal blocks with locking clips, the wiring space between the terminal strips can be covered with a wiring duct cover.

Marking

Supus modificărilor.

WAGO Kontakttechnik GmbH & Co. KG
/Representative Office Romania
Sos. Pipera-Tunari nr. 1/1
building 1, 2nd floor | 077190 Voluntari, Ilfov
Tel.: +40-(0)31 421 85 68 | Email: info-RO@wago.com

Aveți întrebări despre produsele noastre?
Vă stăm la dispoziție pentru preluarea apelului la +40 (0) 31 421 85 68.



Connection points identified via factory-direct printing



Marking coordinates via WMB Multi Marking System.

Supus modificărilor.