

## Fișă tehnică | Număr articol: 280-586/281-496

4-conductor sensor supply terminal block; LED (green); for NPN-(low-side) switching sensors; Power supply from sensor side; with colored conductor entries; 2.5 mm<sup>2</sup>; CAGE CLAMP®; 2,50 mm<sup>2</sup>; gray

[www.wago.com/280-586/281-496](http://www.wago.com/280-586/281-496)

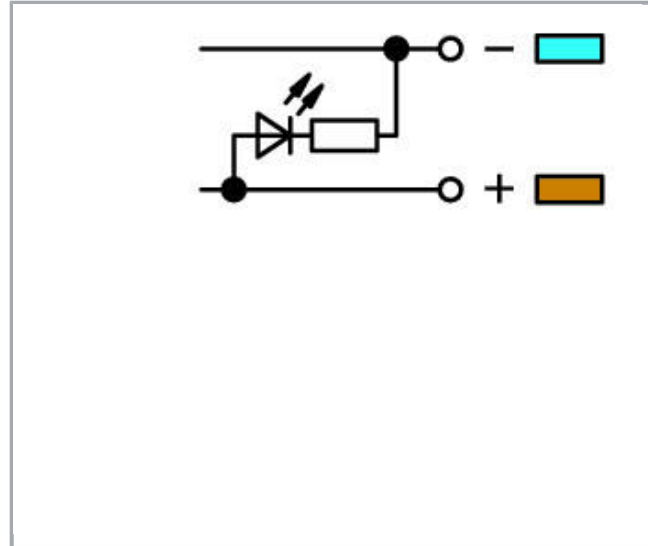
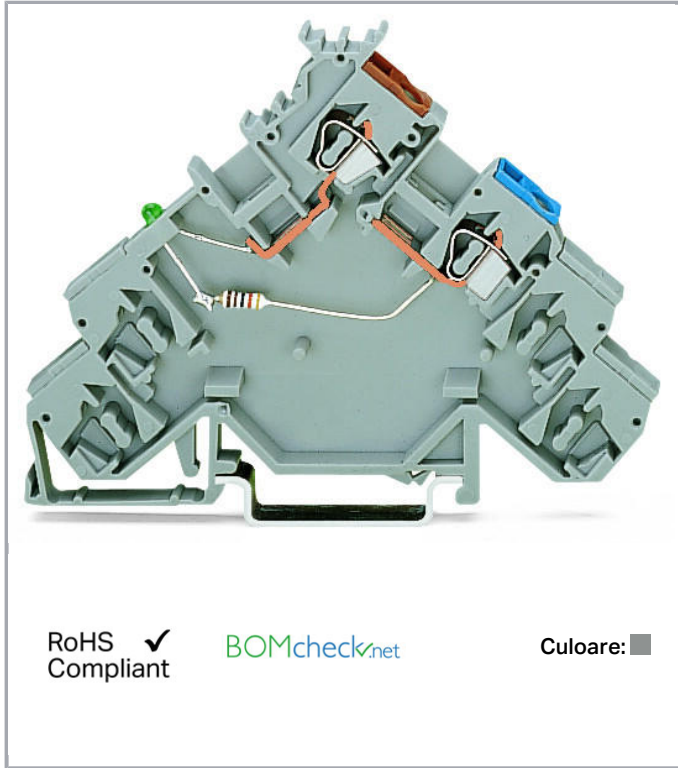

### Descriere articol

#### Note:

##### Terminating Aluminum Conductors

WAGO spring clamp terminal blocks are suitable for solid aluminum conductors up to 4 mm<sup>2</sup>/12 AWG if WAGO "Alu-Plus" Contact Paste is used for termination.

"Alu-Plus" Contact Paste Advantages:

- Automatically destroys the oxide film during clamping.
- Prevents fresh oxidation at the clamping point.
- Prevents electrolytic corrosion between aluminum and copper conductors (in the same terminal block).
- Provides long-term protection against corrosion.

Using terminal blocks with CAGE CLAMP® Spring Pressure Connection Technology, **aluminum conductors must first be cleaned with a blade** and then immediately be inserted into the clamping units filled with "Alu-Plus" Contact Paste.

Supus modificărilor.

WAGO Kontakttechnik GmbH & Co. KG  
/Representative Office Romania  
Sos. Pipera-Tunari nr. 1/1  
building 1, 2nd floor | 077190 Voluntari, Ilfov  
Tel.: +40-(0)31 421 85 68 | Email: [info-RO@wago.com](mailto:info-RO@wago.com)

Aveți întrebări despre produsele noastre?  
Vă stăm la dispoziție pentru preluarea apelului la +40 (0) 31 421 85 68.



It is also possible to apply WAGO "Alu-Plus" **additionally** on the whole surface of the aluminum conductor before termination.

Please note that the nominal currents must be adapted to the reduced conductivity of the aluminum conductors:

2.5 mm<sup>2</sup> (14 AWG) = 16 A

4 mm<sup>2</sup> (12 AWG) = 22 A

**Safety information 1:**

LED power consumption: 4.8mA

## Date

### Electrical data

|                 |      |
|-----------------|------|
| Voltage type 1  | DC   |
| Nominal voltage | 24 V |

### Ratings per IEC/EN 60664-1

|               |      |
|---------------|------|
| Rated current | 20 A |
|---------------|------|

### Connection data

|                                   |  |
|-----------------------------------|--|
| Connection technology             | CAGE CLAMP®                                  |
| Actuation type                    | Operating tool                               |
| Connectable conductor materials   | Copper<br>Aluminum                           |
| Solid conductor                   | 0.08 ... 2.5 mm <sup>2</sup> / 28 ... 12 AWG |
| Fine-stranded conductor           | 0.08 ... 2.5 mm <sup>2</sup> / 28 ... 12 AWG |
| Strip length                      | 8 ... 9 mm / 0.31 ... 0.35 inch              |
| Total number of connection points | 2  |
| Total number of potentials        | 2  |
| Number of levels                  | 4  |
| Wiring type                       | Front-entry wiring                           |
| Note (conductor cross-section)    | 12 AWG: THHN, THWN                           |

### Geometrical Data

|                                    |                      |
|------------------------------------|----------------------|
| Width                              | 5 mm / 0.197 inch    |
| Height from upper-edge of DIN-rail | 63.5 mm / 2.5 inch   |
| Depth                              | 90.5 mm / 3.563 inch |

Supus modificărilor.

WAGO Kontakttechnik GmbH & Co. KG  
/Representative Office Romania  
Sos. Pipera-Tunari nr. 1/1  
building 1, 2nd floor | 077190 Voluntari, Ilfov  
Tel.: +40-(0)31 421 85 68 | Email: info-RO@wago.com

Aveți întrebări despre produsele noastre?  
Vă stăm la dispoziție pentru preluarea apelului la +40 (0) 31 421 85 68.

## Mechanical data

|               |                |
|---------------|----------------|
| Design        | angled         |
| Mounting type | DIN-35 rail    |
| Marking level | Center marking |

## Material Data

|                     |                      |
|---------------------|----------------------|
| Color               | gray                 |
| Insulation material | Polyamide 66 (PA 66) |
| Fire load           | 0,235 MJ             |
| Weight              | 10,5 g               |

## Commercial data



|                       |                                  |
|-----------------------|----------------------------------|
| Product Group         | 1 (Rail Mounted Terminal Blocks) |
| Packaging type        | BOX                              |
| Country of origin     | DE                               |
| GTIN                  | 4045454365806                    |
| Customs tariff number | 85369010000                      |

## Aprobări / certificate

### Country specific Approvals

| Emblemă  | Aprobare                               | Text de aprobare suplimentar | Nume certificat |
|--|--|------------------------------|-----------------|
|  | <b>CCA</b><br>DEKRA Certification B.V. | EN 60947                     | 2160584.53      |

### Ship Approvals

| Emblemă  | Aprobare  | Text de aprobare suplimentar | Nume certificat          |
|--|---|------------------------------|--------------------------|
|  | <b>ABS</b><br>American Bureau of Shipping               | EN 60947                     | 20-<br>HG1941090-<br>PDA |
|  | <b>DNV GL</b><br>Det Norske Veritas, Germanischer Lloyd | -                            | TAE00001V2               |

Supus modificărilor.

WAGO Kontakttechnik GmbH & Co. KG  
/Representative Office Romania  
Sos. Pipera-Tunari nr. 1/1  
building 1, 2nd floor | 077190 Voluntari, Ilfov  
Tel.: +40-(0)31 421 85 68 | Email: info-RO@wago.com

Aveți întrebări despre produsele noastre?  
Vă stăm la dispoziție pentru preluarea apelului la +40 (0) 31 421 85 68.



## UL-Approvals

| Emblemă  | Aprobare                                    | Text de aprobare suplimentar | Nume certificat     |
|--|---|------------------------------|---------------------|
|  | <b>UR</b><br>Underwriters Laboratories Inc. | UL 1059                      | 20190731-<br>E45172 |





## Counterpart

## Produse compatibile

## Insulation stop

|  |   |  |
|--|---|--|
|  | <b>Nr. articol: 280-470</b><br>Insulation stop; 0.08 - 0.2 mm <sup>2</sup> "s" (0.14 mm <sup>2</sup> "f-st"); 5 pieces/strip; white | <a href="http://www.wago.com/280-470">www.wago.com/280-470</a> |
|  | <b>Nr. articol: 280-471</b><br>Insulation stop; 0.25 - 0.5 mm <sup>2</sup> ; 5 pieces/strip; light gray                             | <a href="http://www.wago.com/280-471">www.wago.com/280-471</a> |
|  | <b>Nr. articol: 280-472</b><br>Insulation stop; 0.75 - 1 mm <sup>2</sup> ; 5 pieces/strip   | <a href="http://www.wago.com/280-472">www.wago.com/280-472</a> |















## Carrier rail

|  |   |  |
|--|---|--|
|  | <b>Nr. articol: 210-112</b><br>Steel carrier rail; 35 x 7.5 mm; 1 mm thick; 2 m long; slotted; according to EN 60715; "Hole width 25 mm | <a href="http://www.wago.com/210-112">www.wago.com/210-112</a> |
|  | <b>Nr. articol: 210-113</b><br>Steel carrier rail; 35 x 7.5 mm; 1 mm thick; 2 m long; unslotted; according to EN 60715                  | <a href="http://www.wago.com/210-113">www.wago.com/210-113</a> |
|  | <b>Nr. articol: 210-114</b><br>Steel carrier rail; 35 x 15 mm; 1.5 mm thick; 2 m long; unslotted; similar to EN 60715                   | <a href="http://www.wago.com/210-114">www.wago.com/210-114</a> |
|  | <b>Nr. articol: 210-115</b><br>Steel carrier rail; 35 x 7.5 mm; 1 mm thick; 2 m long; slotted; according to EN 60715; "Hole width 18 mm | <a href="http://www.wago.com/210-115">www.wago.com/210-115</a> |
|  | <b>Nr. articol: 210-118</b><br>Steel carrier rail; 35 x 15 mm; 2.3 mm thick; 2 m long; unslotted; according to EN 60715                 | <a href="http://www.wago.com/210-118">www.wago.com/210-118</a> |

Supus modificărilor.

WAGO Kontakttechnik GmbH & Co. KG  
/Representative Office Romania  
Sos. Pipera-Tunari nr. 1/1  
building 1, 2nd floor | 077190 Voluntari, Ilfov  
Tel.: +40-(0)31 421 85 68 | Email: info-RO@wago.com

Aveți întrebări despre produsele noastre?  
Vă stăm la dispoziție pentru preluarea apelului la +40 (0) 31 421 85 68.

|  |   |  |
|--|---|--|
|  | <b>Nr. articol: 210-196</b><br>Aluminum carrier rail; 35 x 8.2 mm; 1.6 mm thick; 2 m long; unslotted; similar to EN 60715; silver-colored | <a href="http://www.wago.com/210-196">www.wago.com/210-196</a> |
|    | <b>Nr. articol: 210-197</b><br>Steel carrier rail; 35 x 15 mm; 1.5 mm thick; 2 m long; slotted; similar to EN 60715                       | <a href="http://www.wago.com/210-197">www.wago.com/210-197</a> |
|    | <b>Nr. articol: 210-198</b><br>Copper carrier rail; 35 x 15 mm; 2.3 mm thick; 2 m long; unslotted; according to EN 60715; copper-colored  | <a href="http://www.wago.com/210-198">www.wago.com/210-198</a> |
|    | <b>Nr. articol: 210-504</b><br>Steel carrier rail; 35 x 7.5 mm; 1 mm thick; 2 m long; slotted; galvanized; according to EN 60715          | <a href="http://www.wago.com/210-504">www.wago.com/210-504</a> |
|    | <b>Nr. articol: 210-505</b><br>Steel carrier rail; 35 x 7.5 mm; 1 mm thick; 2 m long; unslotted; galvanized; according to EN 60715        | <a href="http://www.wago.com/210-505">www.wago.com/210-505</a> |
|    | <b>Nr. articol: 210-506</b><br>Steel carrier rail; 35 x 15 mm; 1.5 mm thick; 2 m long; unslotted; galvanized; similar to EN 60715         | <a href="http://www.wago.com/210-506">www.wago.com/210-506</a> |
|    | <b>Nr. articol: 210-508</b><br>Steel carrier rail; 35 x 15 mm; 1.5 mm thick; 2 m long; slotted; galvanized; similar to EN 60715           | <a href="http://www.wago.com/210-508">www.wago.com/210-508</a> |
| <b>ferrule</b>   |   |  |
|    | <b>Nr. articol: 216-101</b><br>Ferrule; Sleeve for 0.5 mm <sup>2</sup> / AWG 22; uninsulated; electro-tin plated                          | <a href="http://www.wago.com/216-101">www.wago.com/216-101</a> |
|   | <b>Nr. articol: 216-102</b><br>Ferrule; Sleeve for 0.75 mm <sup>2</sup> / AWG 20; uninsulated; electro-tin plated                         | <a href="http://www.wago.com/216-102">www.wago.com/216-102</a> |
|  | <b>Nr. articol: 216-103</b><br>Ferrule; Sleeve for 1 mm <sup>2</sup> / AWG 18; uninsulated; electro-tin plated                            | <a href="http://www.wago.com/216-103">www.wago.com/216-103</a> |
|  | <b>Nr. articol: 216-104</b><br>Ferrule; Sleeve for 1.5 mm <sup>2</sup> / AWG 16; uninsulated; electro-tin plated                          | <a href="http://www.wago.com/216-104">www.wago.com/216-104</a> |
|  | <b>Nr. articol: 216-201</b><br>Ferrule; Sleeve for 0.5 mm <sup>2</sup> / 20 AWG; insulated; electro-tin plated; white                     | <a href="http://www.wago.com/216-201">www.wago.com/216-201</a> |
|  | <b>Nr. articol: 216-202</b><br>Ferrule; Sleeve for 0.75 mm <sup>2</sup> / 18 AWG; insulated; electro-tin plated; gray                     | <a href="http://www.wago.com/216-202">www.wago.com/216-202</a> |
|  | <b>Nr. articol: 216-203</b><br>Ferrule; Sleeve for 1 mm <sup>2</sup> / AWG 18; insulated; electro-tin plated; red                         | <a href="http://www.wago.com/216-203">www.wago.com/216-203</a> |
|  | <b>Nr. articol: 216-204</b><br>Ferrule; Sleeve for 1.5 mm <sup>2</sup> / AWG 16; insulated; electro-tin plated; black                     | <a href="http://www.wago.com/216-204">www.wago.com/216-204</a> |
|  | <b>Nr. articol: 216-301</b><br>Ferrule; Sleeve for 0.25 mm <sup>2</sup> / AWG 24; insulated; electro-tin plated; yellow                   | <a href="http://www.wago.com/216-301">www.wago.com/216-301</a> |
|  | <b>Nr. articol: 216-302</b><br>Ferrule; Sleeve for 0.34 mm <sup>2</sup> / 22 AWG; insulated; electro-tin plated; green                    | <a href="http://www.wago.com/216-302">www.wago.com/216-302</a> |
| <b>End plate</b>   |   |  |

Supus modificărilor.

**Nr. articol: 280-320**

End and intermediate plate; 1 mm thick; for quadruple-deck terminal blocks; gray

[www.wago.com/280-320](http://www.wago.com/280-320)**Nr. articol: 280-323**

End and intermediate plate; 1 mm thick; for quadruple-deck terminal blocks; orange

[www.wago.com/280-323](http://www.wago.com/280-323)**Protective Warning Marker****Nr. articol: 280-415**

Protective warning marker; with high-voltage symbol, black; for 5 terminal blocks; yellow

[www.wago.com/280-415](http://www.wago.com/280-415)**Marking accessories****Nr. articol: 2009-115**

WMB-Inline; for Smart Printer; 1500 pieces on roll; stretchable 5 - 5.2 mm; plain; snap-on type; white

[www.wago.com/2009-115](http://www.wago.com/2009-115)**Nr. articol: 2009-115/000-002**

WMB-Inline; for Smart Printer; 1500 pieces on roll; stretchable 5 - 5.2 mm; plain; snap-on type; yellow

[www.wago.com/2009-115/000-002](http://www.wago.com/2009-115/000-002)**Nr. articol: 2009-115/000-006**

WMB-Inline; for Smart Printer; 1500 pieces on roll; stretchable 5 - 5.2 mm; plain; snap-on type; blue

[www.wago.com/2009-115/000-006](http://www.wago.com/2009-115/000-006)**Nr. articol: 2009-115/000-007**

WMB-Inline; for Smart Printer; 1500 pieces on roll; stretchable 5 - 5.2 mm; plain; snap-on type; gray

[www.wago.com/2009-115/000-007](http://www.wago.com/2009-115/000-007)**Nr. articol: 2009-115/000-012**

WMB-Inline; for Smart Printer; 1500 pieces on roll; stretchable 5 - 5.2 mm; plain; snap-on type; orange

[www.wago.com/2009-115/000-012](http://www.wago.com/2009-115/000-012)**Nr. articol: 2009-115/000-017**

WMB-Inline; for Smart Printer; 1500 pieces on roll; stretchable 5 - 5.2 mm; plain; snap-on type; light green

[www.wago.com/2009-115/000-017](http://www.wago.com/2009-115/000-017)**Nr. articol: 2009-115/000-023**

WMB-Inline; for Smart Printer; 1500 pieces on roll; stretchable 5 - 5.2 mm; plain; snap-on type; green

[www.wago.com/2009-115/000-023](http://www.wago.com/2009-115/000-023)**Nr. articol: 2009-115/000-024**

WMB-Inline; for Smart Printer; 1500 pieces on roll; stretchable 5 - 5.2 mm; plain; snap-on type; violet

[www.wago.com/2009-115/000-024](http://www.wago.com/2009-115/000-024)**Nr. articol: 793-501**

WMB marking card; as card; not stretchable; plain; snap-on type; white

[www.wago.com/793-501](http://www.wago.com/793-501)**Nr. articol: 793-501/000-002**

WMB marking card; as card; not stretchable; plain; snap-on type; yellow

[www.wago.com/793-501/000-002](http://www.wago.com/793-501/000-002)**Nr. articol: 793-501/000-005**

WMB marking card; as card; not stretchable; plain; snap-on type; red

[www.wago.com/793-501/000-005](http://www.wago.com/793-501/000-005)

Supus modificărilor.

WAGO Kontakttechnik GmbH & Co. KG  
/Representative Office Romania  
Sos. Pipera-Tunari nr. 1/1  
building 1, 2nd floor | 077190 Voluntari, Ilfov  
Tel.: +40-(0)31 421 85 68 | Email: info-RO@wago.com

Aveți întrebări despre produsele noastre?  
Vă stăm la dispoziție pentru preluarea apelului la +40 (0) 31 421 85 68.



**Nr. articol: 793-501/000-006**  
WMB marking card; as card; not stretchable; plain; snap-on type; blue

[www.wago.com/793-501/000-006](http://www.wago.com/793-501/000-006)



**Nr. articol: 793-501/000-007**  
WMB marking card; as card; not stretchable; plain; snap-on type; gray

[www.wago.com/793-501/000-007](http://www.wago.com/793-501/000-007)



**Nr. articol: 793-501/000-012**  
WMB marking card; as card; not stretchable; plain; snap-on type; orange

[www.wago.com/793-501/000-012](http://www.wago.com/793-501/000-012)



**Nr. articol: 793-501/000-017**  
WMB marking card; as card; not stretchable; plain; snap-on type; light green

[www.wago.com/793-501/000-017](http://www.wago.com/793-501/000-017)



**Nr. articol: 793-501/000-023**  
WMB marking card; as card; not stretchable; plain; snap-on type; green

[www.wago.com/793-501/000-023](http://www.wago.com/793-501/000-023)



**Nr. articol: 793-501/000-024**  
WMB marking card; as card; not stretchable; plain; snap-on type; violet

[www.wago.com/793-501/000-024](http://www.wago.com/793-501/000-024)



**Nr. articol: 793-5501**  
WMB marking card; as card; for terminal block width 5 - 17.5 mm; stretchable 5 - 5.2 mm; plain; snap-on type; white

[www.wago.com/793-5501](http://www.wago.com/793-5501)



**Nr. articol: 793-5501/000-002**  
WMB marking card; as card; for terminal block width 5 - 17.5 mm; stretchable 5 - 5.2 mm; plain; snap-on type; yellow

[www.wago.com/793-5501/000-002](http://www.wago.com/793-5501/000-002)



**Nr. articol: 793-5501/000-005**  
WMB marking card; as card; for terminal block width 5 - 17.5 mm; stretchable 5 - 5.2 mm; plain; snap-on type; red

[www.wago.com/793-5501/000-005](http://www.wago.com/793-5501/000-005)



**Nr. articol: 793-5501/000-006**  
WMB marking card; as card; for terminal block width 5 - 17.5 mm; stretchable 5 - 5.2 mm; plain; snap-on type; blue

[www.wago.com/793-5501/000-006](http://www.wago.com/793-5501/000-006)



**Nr. articol: 793-5501/000-007**  
WMB marking card; as card; for terminal block width 5 - 17.5 mm; stretchable 5 - 5.2 mm; plain; snap-on type; gray

[www.wago.com/793-5501/000-007](http://www.wago.com/793-5501/000-007)



**Nr. articol: 793-5501/000-012**  
WMB marking card; as card; for terminal block width 5 - 17.5 mm; stretchable 5 - 5.2 mm; plain; snap-on type; orange

[www.wago.com/793-5501/000-012](http://www.wago.com/793-5501/000-012)



**Nr. articol: 793-5501/000-017**  
WMB marking card; as card; for terminal block width 5 - 17.5 mm; stretchable 5 - 5.2 mm; plain; snap-on type; green

[www.wago.com/793-5501/000-017](http://www.wago.com/793-5501/000-017)



**Nr. articol: 793-5501/000-023**  
WMB marking card; as card; for terminal block width 5 - 17.5 mm; stretchable 5 - 5.2 mm; plain; snap-

[www.wago.com/793-5501/000-023](http://www.wago.com/793-5501/000-023)

Supus modificărilor.

WAGO Kontakttechnik GmbH & Co. KG  
/Representative Office Romania  
Sos. Pipera-Tunari nr. 1/1  
building 1, 2nd floor | 077190 Voluntari, Ilfov  
Tel.: +40-(0)31 421 85 68 | Email: info-RO@wago.com

Aveți întrebări despre produsele noastre?  
Vă stăm la dispoziție pentru preluarea apelului la +40 (0) 31 421 85 68.

on type; light green

**Nr. articol:** 793-5501/000-024

WMB marking card; as card; for terminal block width 5 - 17.5 mm; stretchable 5 - 5.2 mm; plain; snap-on type; violet

[www.wago.com/793-5501/000-024](http://www.wago.com/793-5501/000-024)

## assembling

**Nr. articol:** 709-154

Cover; Type 2; suitable for cover carrier, type 2; 1 m long; transparent

[www.wago.com/709-154](http://www.wago.com/709-154)

## Jumper

**Nr. articol:** 210-103

Wire commoning chain; insulated; 50 connections; black

[www.wago.com/210-103](http://www.wago.com/210-103)**Nr. articol:** 210-123

Wire commoning chain; insulated; 50 connections

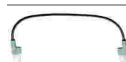
[www.wago.com/210-123](http://www.wago.com/210-123)**Nr. articol:** 249-123Push-in type wire jumper; insulated; wire length 180 mm; Conductor cross section 0.75 mm<sup>2</sup>[www.wago.com/249-123](http://www.wago.com/249-123)**Nr. articol:** 249-125Push-in type wire jumper; insulated; wire length 60 mm; Conductor cross section 0.75 mm<sup>2</sup>[www.wago.com/249-125](http://www.wago.com/249-125)**Nr. articol:** 249-126Push-in type wire jumper; insulated; wire length 110 mm; Conductor cross section 0.75 mm<sup>2</sup>[www.wago.com/249-126](http://www.wago.com/249-126)**Nr. articol:** 249-127Push-in type wire jumper; insulated; wire length 250 mm; Conductor cross section 0.75 mm<sup>2</sup>[www.wago.com/249-127](http://www.wago.com/249-127)**Nr. articol:** 280-402

Adjacent jumper; insulated; IN = IN terminal block; gray

[www.wago.com/280-402](http://www.wago.com/280-402)**Nr. articol:** 280-482

Comb-style jumper bar; insulated; 2-way; IN = IN terminal block; gray

[www.wago.com/280-482](http://www.wago.com/280-482)**Nr. articol:** 280-483

Comb-style jumper bar; insulated; 3-way; IN = IN terminal block; gray

[www.wago.com/280-483](http://www.wago.com/280-483)**Nr. articol:** 280-484

Comb-style jumper bar; insulated; 4-way; IN = IN terminal block; gray

[www.wago.com/280-484](http://www.wago.com/280-484)**Nr. articol:** 280-485

Comb-style jumper bar; insulated; 5-way; IN = IN terminal block; gray

[www.wago.com/280-485](http://www.wago.com/280-485)**Nr. articol:** 280-490

Comb-style jumper bar; insulated; 10-way; IN = IN terminal block; gray

[www.wago.com/280-490](http://www.wago.com/280-490)**Nr. articol:** 280-492

Alternate comb-style jumper bar; insulated; 2-way; IN = IN terminal block; gray













[www.wago.com/280-492](http://www.wago.com/280-492)**Nr. articol:** 709-110

Wire commoning chain; insulated; 4 connections; 3 x 110 mm; black

[www.wago.com/709-110](http://www.wago.com/709-110)

Supus modificărilor.



|  |   |  |
|--|---|--|
|    | <b>Nr. articol: 709-111</b><br>Wire commoning chain; insulated; 3 connections; 2 x 120 mm; black                                    | <a href="http://www.wago.com/709-111">www.wago.com/709-111</a> |
|    | <b>Nr. articol: 709-112</b><br>Wire commoning chain; insulated; 3 connections; 2 x 170 mm; black                                    | <a href="http://www.wago.com/709-112">www.wago.com/709-112</a> |
|    | <b>Nr. articol: 780-452</b><br>Staggered jumper; insulated; from 1 to 2; Spacing: 5 mm; suitable for 2-conductor female plugs; gray | <a href="http://www.wago.com/780-452">www.wago.com/780-452</a> |
|    | <b>Nr. articol: 780-453</b><br>Staggered jumper; insulated; from 1 to 3; Spacing: 5 mm; suitable for 2-conductor female plugs; gray | <a href="http://www.wago.com/780-453">www.wago.com/780-453</a> |
|    | <b>Nr. articol: 780-454</b><br>Staggered jumper; insulated; from 1 to 4; Spacing: 5 mm; suitable for 2-conductor female plugs; gray | <a href="http://www.wago.com/780-454">www.wago.com/780-454</a> |
|    | <b>Nr. articol: 780-455</b><br>Staggered jumper; insulated; from 1 to 5; Spacing: 5 mm; suitable for 2-conductor female plugs; gray | <a href="http://www.wago.com/780-455">www.wago.com/780-455</a> |
|    | <b>Nr. articol: 780-456</b><br>Staggered jumper; insulated; from 1 to 6; Spacing: 5 mm; suitable for 2-conductor female plugs; gray | <a href="http://www.wago.com/780-456">www.wago.com/780-456</a> |
|    | <b>Nr. articol: 780-457</b><br>Staggered jumper; insulated; from 1 to 7; Spacing: 5 mm; suitable for 2-conductor female plugs; gray | <a href="http://www.wago.com/780-457">www.wago.com/780-457</a> |
|    | <b>Nr. articol: 780-458</b><br>Staggered jumper; insulated; from 1 to 8; Spacing: 5 mm; suitable for 2-conductor female plugs; gray | <a href="http://www.wago.com/780-458">www.wago.com/780-458</a> |
| <b>tools</b>   |   |  |
|  | <b>Nr. articol: 210-657</b><br>Operating tool; Blade: 3.5 x 0.5 mm; with a partially insulated shaft; short                         | <a href="http://www.wago.com/210-657">www.wago.com/210-657</a> |
|  | <b>Nr. articol: 210-658</b><br>Operating tool; Blade: 3.5 x 0.5 mm; with a partially insulated shaft; angled; short                 | <a href="http://www.wago.com/210-658">www.wago.com/210-658</a> |
|  | <b>Nr. articol: 210-720</b><br>Operating tool; Blade: 3.5 x 0.5 mm; with a partially insulated shaft                                | <a href="http://www.wago.com/210-720">www.wago.com/210-720</a> |

## Descărcări

### Documentation

#### Additional Information

|                        |             |               |            |
|------------------------|-------------|---------------|------------|
| Technical explanations | Apr 3, 2019 | pdf<br>2,1 MB | Descărcare |
|------------------------|-------------|---------------|------------|

### CAD/CAE-Data

#### CAD data

|                              |     |            |
|------------------------------|-----|------------|
| 2D/3D Models 280-586/281-496 | URL | Descărcare |
|------------------------------|-----|------------|

Supus modificărilor.

WAGO Kontakttechnik GmbH & Co. KG  
/Representative Office Romania  
Sos. Pipera-Tunari nr. 1/1  
building 1, 2nd floor | 077190 Voluntari, Ilfov  
Tel.: +40-(0)31 421 85 68 | Email: info-RO@wago.com

Aveți întrebări despre produsele noastre?  
Vă stăm la dispoziție pentru preluarea apelului la +40 (0) 31 421 85 68.

## CAE data

EPLAN Data Portal 280-586/281-496

URL

Descărcare

WSCAD Universe 280-586/281-496

URL

Descărcare

## Installation Notes

### Installation

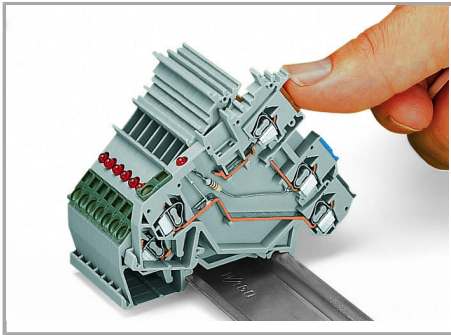

Snapping a terminal block onto the carrier rail – terminal blocks with a grounding foot automatically establish a direct contact to the rail.

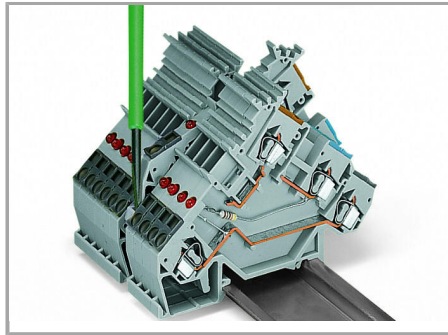

Removing a terminal block from the carrier rail. Notice: Remove jumper contacts first.

### Conductor termination

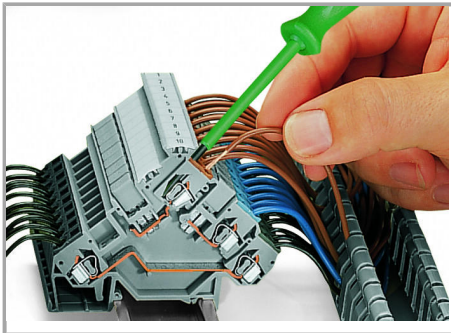

CAGE CLAMP® connection

Inserting a conductor via straight operating tool (210-720).

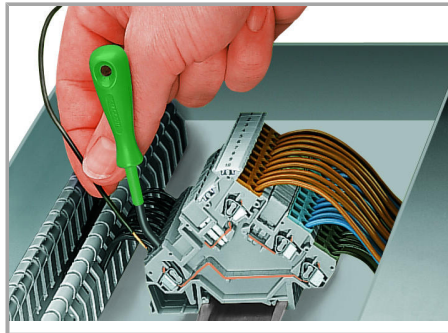

CAGE CLAMP® connection

Inserting a conductor via angled operating tool (210-658).

### Commoning

Supus modificărilor.

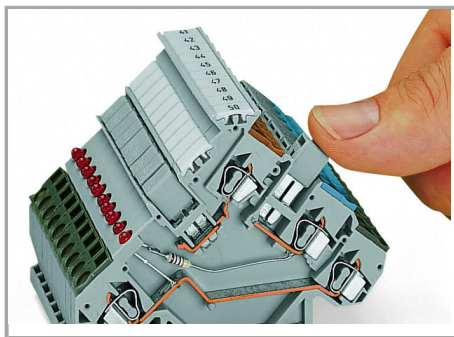

Commoning using an adjacent jumper (280-402).

Push jumper down until fully inserted.

#### Testing

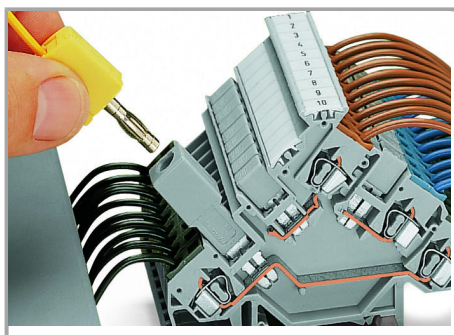

Testing via banana plug and test plug adapter (209-170).

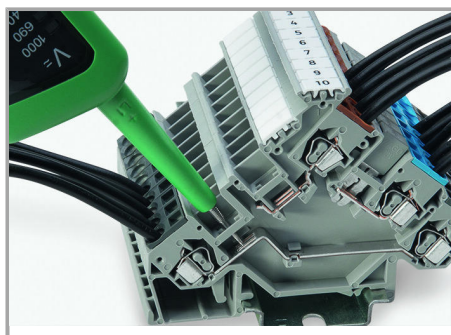

Testing via voltage tester directly on the current bar.

#### Installation

Supus modificărilor.

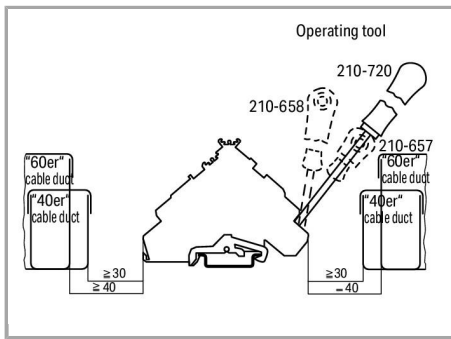

Min. mounting distance – terminal blocks to cable duct

### Marking

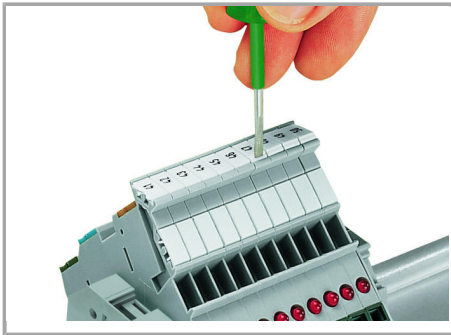

Labeling via WMB Multi Marking System.

Supus modificărilor.