

Fișă tehnică | Număr articol: 294-5453

Lighting connector; push-button, external; with screw-type ground contact;
3-pole; Lighting side: for solid conductors; Inst. side: for all conductor types;
max. 2.5 mm²; Surrounding air temperature: max 85°C (T85); 2,50 mm²; white

www.wago.com/294-5453

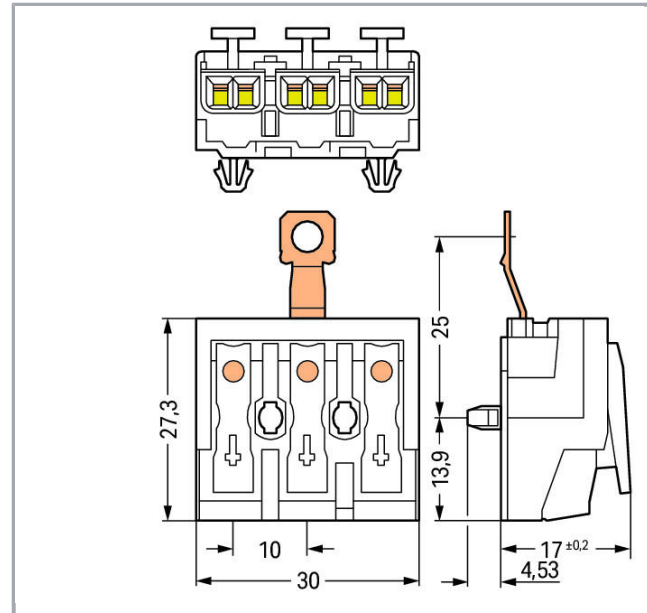
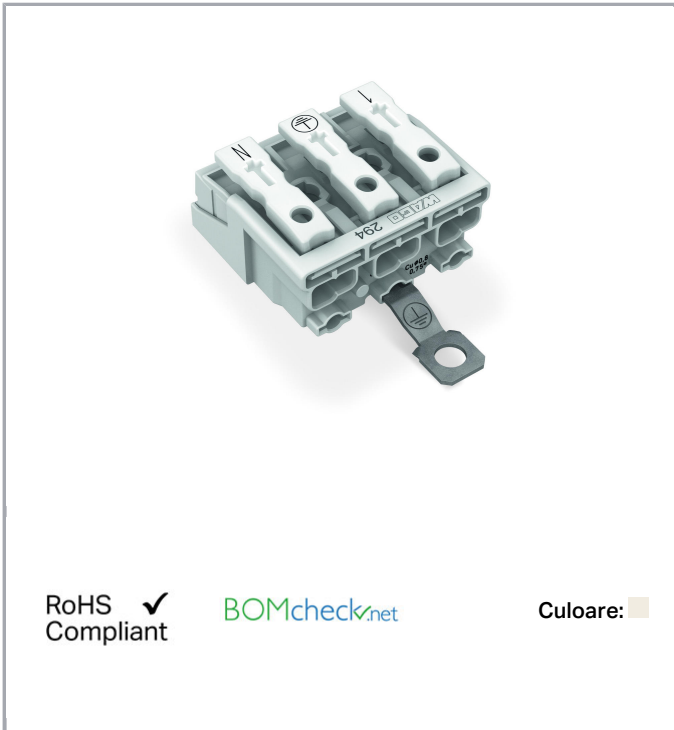

Descriere articol

- External connection of solid, stranded and fine-stranded conductors
- Universal conductor termination (AWG, metric)
- Third contact at bottom
- Strain relief plate can be retrofitted

Date

Electrical data

Ratings per IEC/EN 60664-1

Ratings per	IEC/EN 60998-1
Ratings (note)	Connection points
Nominal voltage (II/2)	500 V

Supus modificărilor.

WAGO Kontakttechnik GmbH & Co. KG
/Representative Office Romania
Sos. Pipera-Tunari nr. 1/1
building 1, 2nd floor | 077190 Voluntari, Ilfov
Tel.: +40-(0)31 421 85 68 | Email: info-RO@wago.com

Aveți întrebări despre produsele noastre?
Vă stăm la dispoziție pentru preluarea apelului la +40 (0) 31 421 85 68.



Rated surge voltage (II/2)	4 kV
Rated current	24 A
Ratings per	IEC/EN 60998-2-2
Ratings (note) 2	Connection points
Rated voltage (II/2) 2	500 V
Rated surge voltage (II/2) 2	4 kV
Rated current 2	24 A
Rated current 3	16 A
Legend (ratings)	(II / 2) Δ Overvoltage category II / Pollution degree 2

Connection data

Connection type (1)	External 1
Connection technology	Push-in CAGE CLAMP®
Number of connection points (connection type)	2
Actuation type	Operating tool Push-button
Connectable conductor materials	Copper
Solid conductor	0,5 ... 2,5 mm ² / 18 ... 12 AWG
Solid conductor; push-in termination	0,5 ... 2,5 mm ² / 18 ... 12 AWG
Stranded conductor	0,5 ... 2,5 mm ² / 18 ... 14 AWG
Fine-stranded conductor	0,5 ... 2,5 mm ² / 18 ... 14 AWG
Fine-stranded conductor; with insulated ferrule	0,5 ... 1,5 mm ² / 18 ... 16 AWG
Fine-stranded conductor; with uninsulated ferrule	0,5 ... 1,5 mm ² / 18 ... 16 AWG
Fine-stranded conductor; with ferrule; push-in termination	0,5 mm ² / 18 AWG
Strip length	8 ... 9 mm / 0.31 ... 0.35 inch
Pole No.	3
Connection type 2	Internal 2
Connection technology 2	PUSH WIRE®
Number of connection points	1
Solid conductor 2	0,5 ... 2,5 mm ² / 18 ... 14 AWG
Fine-stranded conductor; with insulated ferrule 2	0,5 ... 1 mm ² / 18 ... 16 AWG
Fine-stranded conductor; with uninsulated ferrule 2	0,5 ... 1,5 mm ² / 18 ... 14 AWG
Strip length 2	8 ... 9 mm / 0.31 ... 0.35 inch
Connection type (3)	Internal 3
Number of connection points	1
Solid conductor 3	0,5 ... 1,5 mm ² / 18 ... 16 AWG
Fine-stranded conductor; with insulated ferrule 3	0,5 ... 0,75 mm ² / 18 AWG 0,5 ... 0,75 mm ² / 18 AWG

Supus modificărilor.

WAGO Kontakttechnik GmbH & Co. KG
/Representative Office Romania
Sos. Pipera-Tunari nr. 1/1
building 1, 2nd floor | 077190 Voluntari, Ilfov
Tel.: +40-(0)31 421 85 68 | Email: info-RO@wago.com

Aveți întrebări despre produsele noastre?
Vă stăm la dispoziție pentru preluarea apelului la +40 (0) 31 421 85 68.

Fine-stranded conductor; with uninsulated ferrule 3	0,5 ... 1 mm ² / 18 AWG
Connection type (4)	Internal 4
Number of connection points	1
Solid conductor 4	0,5 ... 0,75 mm ² / 18 AWG
Total number of connection points	15
Total number of potentials	3
Number of connection types	4
Wiring type	Side-entry wiring
Ground function	with screw-type ground contact

Geometrical Data

Pin spacing	10 mm / 0.394 inch
Width	30 mm / 1.181 inch
Height from the surface	17 mm / 0.669 inch
Depth	27,3 mm / 1.075 inch

Mechanical data

Mounting type	Snap-in mounting foot
Marking	1-PE-N

Material Data

Color	white
Material group	III a
Insulation material	Polycarbonate (PC)
Flammability class per UL94	V0
Clamping spring material	Chrome nickel spring steel (CrNi)
Contact material	Electrolytic copper (E _{Cu})
Contact plating	tin-plated
Fire load	0,183 MJ
Weight	9,9 g

Environmental Requirements

Temperature stability	120 °C
T marking	T85

Supus modificărilor.

Commercial data

Product Group	8 (Misc. Chassis Mount Blocks)
Packaging type	bag
Country of origin	PL
GTIN	4050821098638
Customs tariff number	85369010000

Aprobări / certificate



Country specific Approvals

Emblemă	Aprobare	Text de aprobare suplimentar	Nume certificat
	ENEC 05 DEKRA Certification B.V.	EN 60998	2128791.01





Counterpart

Produse compatibile

tools

	Nr. articol: 206-294 Disconnection tool	www.wago.com/206-294
	Nr. articol: 294-199 Operating tool; for pressing the snap-in mounting feet into the mounting plate; For fitting ground contacts; for 294 Series	www.wago.com/294-199

Strain relief plate

	Nr. articol: 294-364 Strain relief plate; for 294 Series; for multicore cables; 3- to 5-pole; with secured clamp; white	www.wago.com/294-364
	Nr. articol: 294-370 Strain relief; for 294 Series; with snap-in mounting feet; white	www.wago.com/294-370
	Nr. articol: 294-375 Strain relief; for 294 Series; without snap-in mounting feet; white	www.wago.com/294-375
	Nr. articol: 294-384 Strain relief plate; for 294 Series; for single strands; 3- to 5-pole; with secured clamp; white	www.wago.com/294-384

Supus modificărilor.

WAGO Kontakttechnik GmbH & Co. KG
 /Representative Office Romania
 Sos. Pipera-Tunari nr. 1/1
 building 1, 2nd floor | 077190 Voluntari, Ilfov
 Tel.: +40-(0)31 421 85 68 | Email: info-RO@wago.com

Aveți întrebări despre produsele noastre?
 Vă stăm la dispoziție pentru preluarea apelului la +40 (0) 31 421 85 68.

Descărcări
Documentation

Additional Information
Technical explanations

Apr 3, 2019

pdf
2,1 MB

Descărcare

CAD/CAE-Data

CAD data

2D/3D Models 294-5453

URL

Descărcare

CAE data

WSCAD Universe 294-5453

URL

Descărcare

Installation Notes

Installation

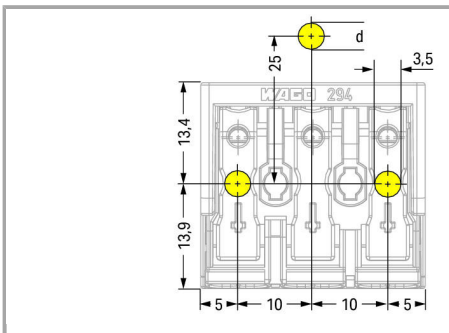

3-pole – with screw-type ground contact, $d \leq 4.1$ mm

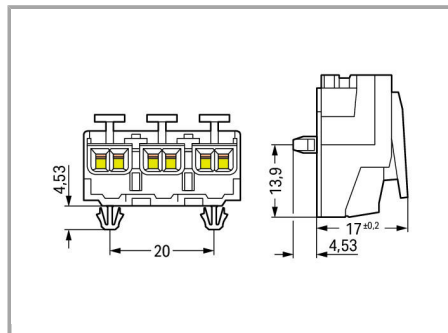

Snap-in mounting foot

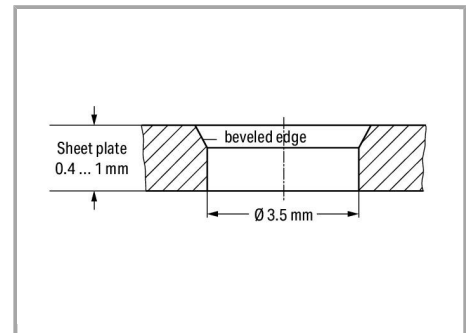

Drilled hole for snap-in mounting foot

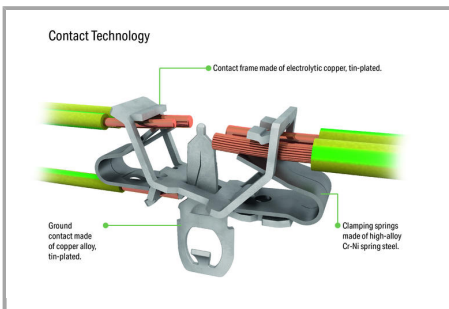

Supus modificărilor.

EUROPE
1 x 0.5 ... 2.5 mm ² "s"
1 x 0.5 ... 1.5 mm ² "s"
1 x 0.5 ... 0.75 mm ² "s"
AMERICA
1 x AWG 18 ... 14 "s"
1 x AWG 18 ... 16 "s"
1 x AWG 18 "s"
JAPAN
1 x 0.8 ... 1.6 mm diam. "s"
1 x 0.8 ... 1 mm diam. "s"
1 x 0.8 mm diam. "s"

EUROPE
2 x 0.5 ... 2.5 mm ² "s, str, f-str"
AMERICA
2 x AWG 18 ... 12 "s"
2 x AWG 18 ... 14 "s, f-str"
JAPAN
2 x 0.8 ... 2 mm diam. "s"
2 x 0.5 ... 2 mm ² "str, f-str"

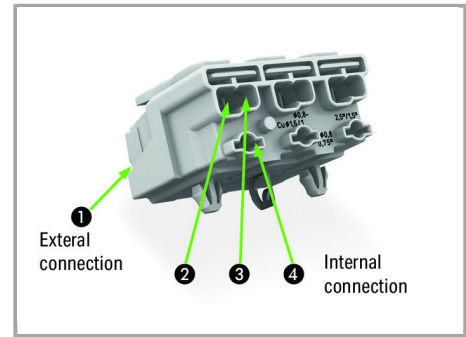

Internal connection:

External connection:

PUSH WIRE® for internal wiring with solid conductors

Push-in CAGE CLAMP® for field-wiring with all conductor types

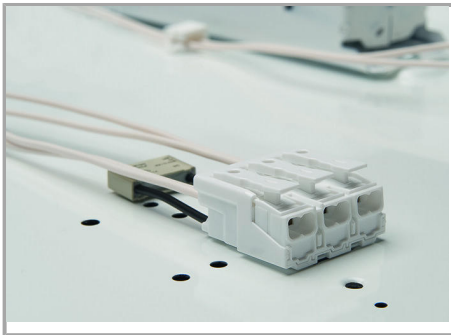

Terminating five conductors per pole – solid and fine-stranded.

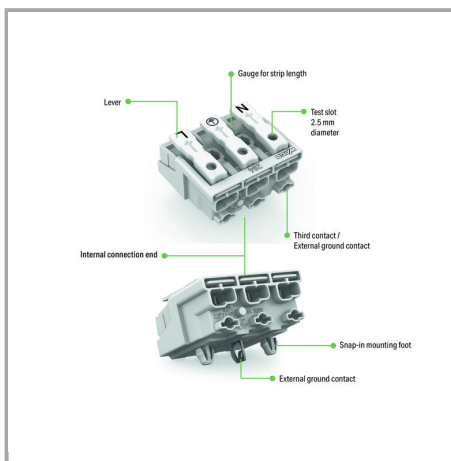

Supus modificărilor.

WAGO Kontakttechnik GmbH & Co. KG
 /Representative Office Romania
 Sos. Pipera-Tunari nr. 1/1
 building 1, 2nd floor | 077190 Voluntari, Ilfov
 Tel.: +40-(0)31 421 85 68 | Email: info-RO@wago.com

Aveți întrebări despre produsele noastre?
 Vă stăm la dispoziție pentru preluarea apelului la +40 (0) 31 421 85 68.