

Capete chei tubulare cu cardan 3/8"

238/1F12p

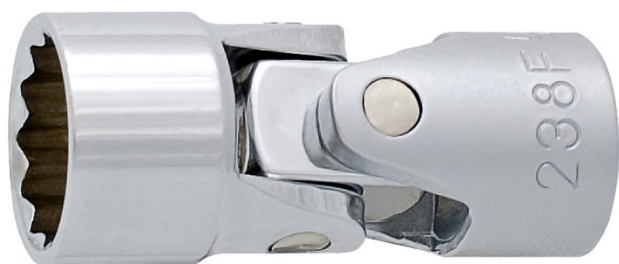

Profile



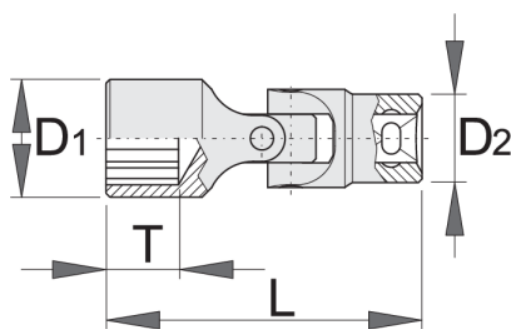

Caracteristicile produsului

- material:crome vanadium
- forjata, calire si revenire totala
- acoperire cromare conform ISO 1456:2009
- polizate



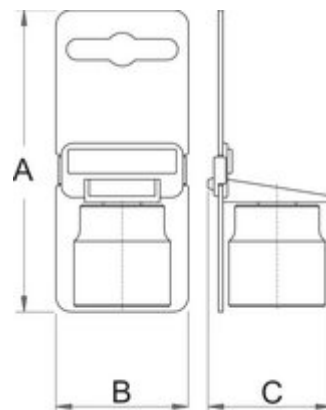

Barcode	mm	L	D1	D2	T↑	Icon	
619793	10	51	14.2	18.8	6	57	1
619794	11	52	15.5	18.8	7	57	1
619795	12	52	16.7	18.8	8	61	1
619796	13	53	18	18.8	8	65	1
619797	14	53	19	18.8	10	65	1

		L	D1	D2	T↑		
619798	15	54	20.5	18.8	10	70	1
619799	16	54	21.7	18.8	10	70	1
619800	17	56	23	18.8	10	68	1
619801	18	56	24.2	18.8	12	75	1
619802	19	57	25.5	18.8	12	75	1







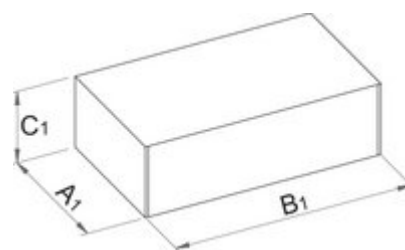

Ambalaj pentru retail

	MA	MB	MC	
619793	110	44	34	62
619794	110	44	34	62
619795	110	44	34	66
619796	110	44	34	70
619797	110	44	34	70
619798	110	44	34	75
619799	110	44	34	75
619800	115	44	34	73
619801	115	44	34	80
619802	115	44	34	80



Ambalaj pentru transport

		TA	TB	TC	
619793	4	83	131	55	373
619794	4	83	131	55	373

		TA	TB	TC	
619795	4	83	131	55	389
619796	4	83	131	55	405
619797	4	83	131	55	405
619798	4	83	131	55	425
619799	4	93	144	57	425
619800	4	93	144	57	417
619801	4	94	150	59	445
619802	4	94	150	59	445