

Clesti de cuie

530/4P



0



Profile

Premium +

Caracteristicile produsului

- material:compozitie speciala pentru calire revenire
- tratat complet
- partile taietoare tratate prin inductie
- cap vopsit
- acoperire:fosfatare conform standardului ISO 9717
- manere de plastic
- conform cu standardul ISO 9243

Standarde

DIN ISO 9243 tip A

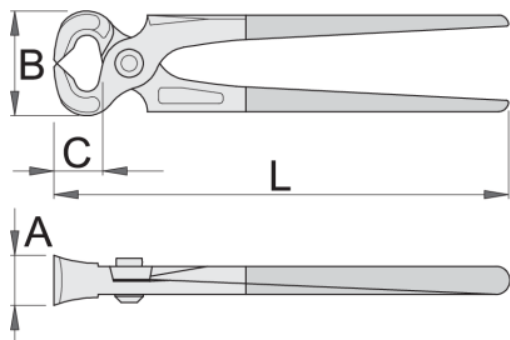

608722

L

160

B

46

A



22

C

16



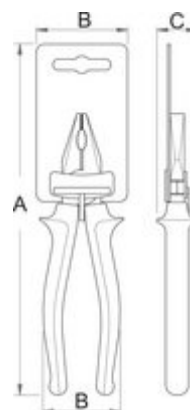

242

	L	B	A	C	
608723	180	50	23	21	309
608724	200	54	25	24	427
608725	225	54	25	24	419
608726	250	58	26	27	557



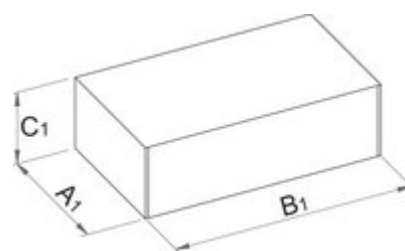

Ambalaj pentru retail

	MA	MB	MC	
608722	235	72	37	255
608723	255	72	27	322
608724	270	72	27	440
608725	280	72	27	432
608726	310	72	27	570



Ambalaj pentru transport

		TA	TB	TC	
608722	4	134	268	53	1145
608723	4	145	358	48	1413
608724	4	109	377	65	1885
608725	4	145	358	48	1853
608726	4	145	358	48	2405