

Polizor pneumatic

1510

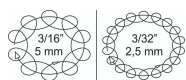

0



Profile



Caracteristicile produsului

- viteza de rotatie 1000 rotatii/minut
- Presiunea maxima de aer comprimat: 6, 2 Bar
- consum de aer comprimat 368 l/min
- Racord de aer 1/4"
- Masina pneumatica de slefuit

Avantaje:

- forma ergonomica a manerului asigura o prindere ferma si impiedica alunecarea
- utilizabil atat pentru mana dreapta cat si pentru mana stanga
- silentios si usor de manevrat
- buton manual de on/off
- exhaustarea particulelor intr-un sac pentru o suprafata de lucru curata.

- furtun robust si flexibil pentru curatirea prafului
- nu sunt permise colturi pe suprafata de lucru
- conditii mai bune de lucru datorita vibratiilor minime
- putere mare bazata pe greutate (1.2 kg)

Utilizare:

- ateliere de tinichigerie
- pregatirea diferitelor suprafete de lucru pentru operatiile ulterioare
- ideal pentru slefuirea suprafetelor metalice, metale si lemn
- Baza slefuitorului este VELCRO™ sistem care asigura slefuirea simpla, usoara, rapida si in siguranta a diferitelor parti de slefuit. Sistemul este utilizat pentru diverse ocazii , cel mai cunoscut exemplu pantofii de sport cu sistem VELCRO™

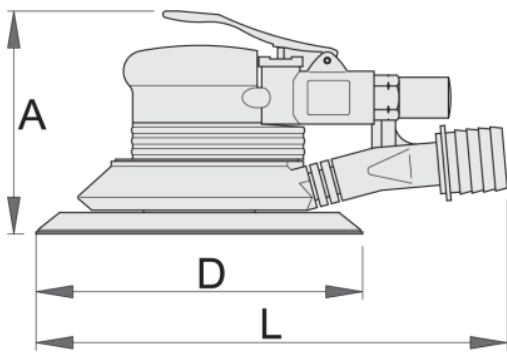

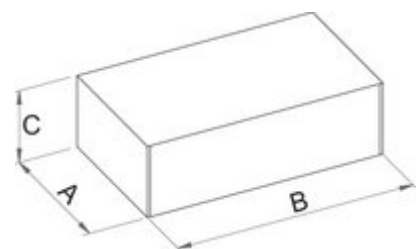

Barcode	Nº	L	A	D	Icon
617733	2.5	220	105	150	1600
617713	5	220	105	150	1615





Ambalaj pentru retail

Barcode	MA	MB	MC	Icon

	MA	MB	MC	
617733	185	400	110	1670
617713	185	400	110	1685

Ambalaj pentru transport

		TA	TB	TC	
617733	1				
617713	1				