

# Dispozitiv de montat pistoane

2205

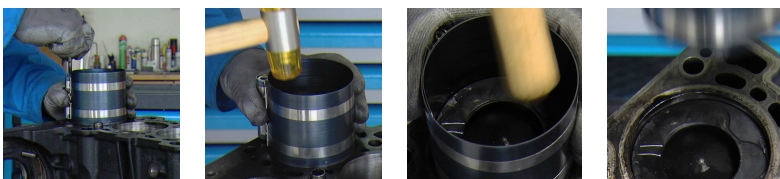

0



Profile

## Caracteristicile produsului

- utilizat pentru montarea pistoanelor la majoritatea autoturismelor
- construcie de inalta calitate cu carcasa din otel de arc
- cu surub de inchidere si reglare



- disponibili intr-o mare varietate de marimi
- Aceasta scula este utilizata pentru montarea pistoanelor si inelelor de pistoane in cilindru. Diferite dimensiuni sunt disponibile.

### Cum sa utilizați scula:

- Introduceți pistonul și garniturile în interiorul dispozitivului și introduceți în camera cilindrului

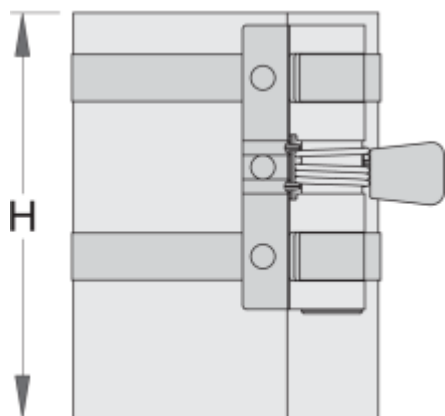
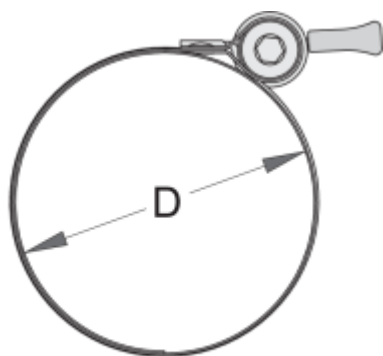

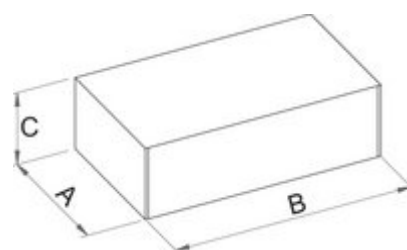

	H	D"	D	
619725	50	1 3/4" - 3 1/2"	40 - 90	178
619726	80	2 1/4" - 5"	57 - 125	291
619727	80	3 1/2" - 7"	90 - 175	320
619729	165	3 1/2" - 7"	90 - 175	587





### Ambalaj pentru retail

	MA	MB	MC	
--	----	----	----	--

	MA	MB	MC	
619725	90	112	58	248
619726	107	120	93	361
619727	107	123	92	390
619729	120	170	100	657

## Ambalaj pentru transport

		TA	TB	TC	
619725	1	90	112	58	248
619726	1	107	120	93	361
619727	1	107	123	92	390
619729	1	120	170	100	657