

Menghina de tamplarie

702/2MH



0



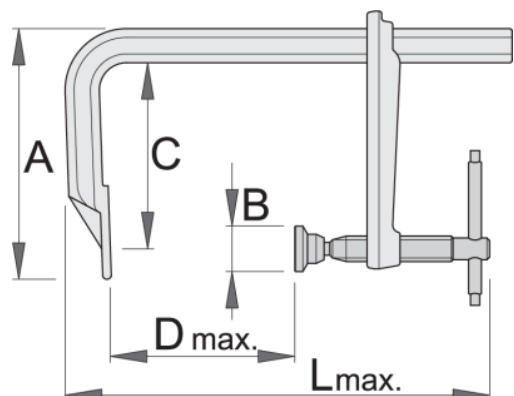

Profile





Caracteristicile produsului



- material: otel special de scule
- tratament termic total
- acoperire: cromare in conformitate cu EN 12540, surubul brunat
- destinate pentru industria de prelucrare a lemnului si constructii
- maner metalic



	D↑	C	L↑	A	B	
608433	120	100	330	155	25	705
608434	160	100	370	155	25	750
608435	200	100	410	155	25	800
608436	250	100	460	155	25	855
608360	300	120	550	180	35	1765
608437	400	120	650	180	35	1975
608438	500	120	750	180	35	2205
608439	600	120	850	180	35	2395
608441	1000	120	1250	180	35	3250

Ambalaj pentru retail

	MA	MB	MC	
608433	150	215	25	705
608434	150	255	60	750
608435	150	295	25	800
608436	150	345	25	855
608360	180	385	48	1765
608437	180	490	33	1975
608438	180	590	33	2205
608439	180	690	33	2395
608441	180	1090	33	3250

Ambalaj pentru transport

		TA	TB	TC	
608433	2	155	270	53	1530
608434	2	155	270	53	1620
608435	2	155	315	53	1720
608436	2	155	360	48	1830
608360	2	410	238	48	3650
608437	2	235	510	45	4070

		TA	TB	TC	
608438	2	235	615	44	4530
608439	2	230	715	41	4910
608441	2	235	1180	42	6620