



MADE IN  
ITALY

**GENERAL CATALOGUE**

**2017**

## Corporate Management

### Geom. Giancarlo Fumagalli Managing Director

Holder of a diploma by the technical high school for building surveyor, he is the creator of this composite material lighting system.  
He speaks Italian and French.

*Diplomato alla scuola tecnica per geometri, è ideatore di questo sistema di lampade in materiale composito. Parla italiano e francese.*



### Dr. Marisa Rabuffetti Finance Director

Graduate by the Milan University in economic sciences, she is teacher of banking and commercial technique. She speaks Italian, English and French.

*Laureata all'università di Milano in scienze economiche, è insegnante alle scuole superiori di tecnica commerciale e bancaria. Parla italiano, inglese e francese.*



### Dr. Chiara Fumagalli Developing Dept. Manager

Graduate by the Milan University in philosophy, she is holder of a diploma in foreign languages: she can speak and write in Italian, English, German French.

*Laureata all'università di Milano in filosofia, è diplomata in lingue straniere: scrive e parla italiano, inglese, tedesco e francese.*



### Arch. Paolo Fumagalli Technical Dept. Manager

Graduate in architecture by the polytechnic University of Milan, he achieved the specialization in lighting technique by the University of Manchester (U. K.). He speaks Italian and English.

*Laureato in architettura al Politecnico di Milano, ha conseguito la specializzazione in illuminotecnica all'università di Manchester (U.K.). Parla italiano e inglese.*



### Dr. Emmanuele Fumagalli Assistant General Manager Human Resources Manager

Graduate by the Milan University in jurisprudence, he achieved the specialization in international law. He speaks Italian and English.

*Laureato in Giurisprudenza all'università di Milano con specializzazione in diritto internazionale. Parla italiano e inglese.*



COMPANY

BULKHEAD  
22

MARTA  
UP/DOWN



24

FRANCY  
UP/DOWN



28

FRANCY-OP  
RECTANGULAR



30

BERTINA  
SMALL ROUND



34

BERTA  
MEDIUM ROUND



38

UMBERTA  
LARGE ROUND



42

GELMI  
ROUND



48

FLOODLIGHT  
80

MINITOMMY  
FLOODLIGHT&SPIKE



82

MINITOMMY-EL  
FLOODLIGHT&SPIKE



86

TOMMY  
FLOODLIGHT&SPIKE



88

IN-GROUND  
112

BRICKLIGHT  
126

BOLLARDS  
160

GARDEN  
172

ANNA  
SMALL LANTERN



174

SABA  
SMALL LANTERN



180

RUT  
MEDIUM LANTERN



186

URBAN  
CLASSIC  
228

NOEMI  
LARGE LANTERN



230

URBAN  
MODERN  
338

GIORGIO  
POLE FLOODLIGHT



340

ROSA  
POLE FLOODLIGHT



340

ECOVIVI 400  
LARGE SIZE



346

VIVI 400  
LARGE SIZE



356

REMO 400  
LARGE SIZE



366

HIGH-BAY  
440

POST  
450

LAMPS  
468

REFERENCES

DANZI OVAL  52	STUCCHI SQUARE  56	CECCHI RECTANGULAR  60	RITA ROUND CLASSIC  64	LUCIA ROUND  68	REMI/LUCIA ROUND WITH BRACKET  72	MADDI OVAL  74	REMI/MADDI OVAL WITH BRACKET  78
--	---	---	---	--	---	---	---

**BULKHEAD  
22**

TOMMY-EL FLOODLIGHT&SPIKE  92	TOMMY-SQ FLOODLIGHT&SPIKE  94	GIOVA/GERMANA FLOODLIGHT  96	GERMANA WALL FLOODLIGHT  100	PINELA SMALL POLE  102	GIOVA/GIUSEPPE FLOODLIGHT  104	GIUSEPPE WALL FLOODLIGHT  108	PINA SMALL POLE  110
---	--	---	---	---	--	--	---

**FLOODLIGHT  
80**

CECI 90 IN-GROUND  114	CECI 120 IN-GROUND  118	CECI 160 IN-GROUND  122
--	--	--

**IN-GROUND  
112**

LETI 100 ROUND RECESSED  128	LETI 100 SQUARE RECESSED  132	LETI 200 RECESSED  136	LETI 300 RECESSED  140	EXTRALETI 100 ROUND SURFACE  144	EXTRALETI 100 SQUARE SURFACE  148	EXTRALETI 200 SURFACE  152	EXTRALETI 300 SURFACE  156
--	--	---	---	---	---	---	---

**BRICKLIGHT  
126**

SAURO LED BOLLARD  162	MIRELLA LED WALL LAMP  164	SAURO E27 BOLLARD  166	MIRELLA E27 WALL LAMP  168	NARDO CHAIN BOLLARD  170
--	--	--	--	--

**BOLLARDS  
160**

SALEM MEDIUM LANTERN  192	GOLIA MEDIUM LANTERN  198	CEFA MEDIUM LANTERN  204	IESSE SMALL HALF LANTERN  210	DARIA LARGE HALF LANTERN  212	GLOBE 250 classic SMALL SIZE  214	GLOBE 300 classic MEDIUM SIZE  218	GLOBE 300 modern MEDIUM SIZE  224
---	--	---	--	--	---	---	--

**GARDEN  
172**

SIOE LARGE LANTERN  246	TOBIA LARGE LANTERN  262	SIMON LARGE LANTERN  278	ELIA GRAND LANTERN  294	PIETRO GRAND LANTERN  304	GLOBE 400 classic LARGE SIZE  314	GLOBE 500 classic GRAND SIZE  326	CANA 500 GRAND SIZE  332
---	---	---	--	--	---	--	---

**URBAN CLASSIC  
228**

GINO 400 LARGE SIZE  376	ECOVIMI 500 GRAND SIZE  386	VIMI 500 GRAND SIZE  394	BEPPE 500 GRAND SIZE  402	REMO 500 GRAND SIZE  410	GINO 500 GRAND SIZE  418	GLOBE 400 modern LARGE SIZE  426	GLOBE 500 modern GRAND SIZE  434
--	--	---	--	---	--	---	---

**URBAN MODERN  
338**

LUIGI 400 LARGE SIZE  442	LUIGI 500 GRAND SIZE  446
--	--

**HIGH-BAY  
440**

CLASSIC POST  452	MODERN POST  460
--	---

**POST  
450**

E27 FILAMENT A60  472	E27 FILAMENT A70  472	GX53 Ø75  474	GX53 Ø100  475	GX53 Ø180  476	GU10  477
--	--	--	--	---	--

**LAMPS  
468**

REFERENCES

# 1973

1972 1974 1975 1976 1977 1978 1979 1980 1981 1982 1983

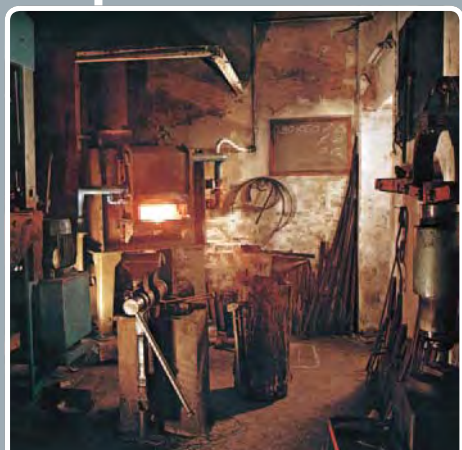

Thanks to the enterprise of Mr. Fumagalli Giancarlo, in 1973 an individual company called "La Bottega dei Maestri Forgiatori" was born in Varese (north of Italy) specialising itself in the artistic handwork of wrought iron indoor lightings. After five years of activity the company started to employ some workers and to open itself to foreign markets, in particular to the Japanese one.

*Nasce a Varese, su iniziativa del Sig. Fumagalli una ditta individuale con il nome di "La Bottega dei Maestri Forgiatori", specializzata nella lavorazione artistica del ferro forgiato a mano. La produzione è costituita da lampade da interno. Dopo cinque anni l'azienda apre verso mercati esteri (in particolare il Giappone), inizia ad assumere i primi dipendenti.*

# 1984

1985 1986 1987 1988 1989 1990 1991 1992 1993 1994 1995 1996 1997 1998



An intuition of Mr. Fumagalli lead the company to an evolution, creating an innovative outdoor lightings production system, consisting of a galvanized steel tube covered by resin material. After some years of experimentation and the setting-up of adequate machineries, the product started to be appreciated all over the world.

*Un'intuizione del Sig. Fumagalli porta l'azienda ad un'evoluzione, creando un ingegnoso processo produttivo di lampade da esterno, costituito da un'anima in acciaio galvanizzato rivestito in resina. Dopo anni di sperimentazioni e la faticosa messa a punto di un'attrezzatura adeguata, il prodotto comincia ad essere distribuito ed apprezzato in tutto il mondo.*

# 1999

2000



Fumagalli family decides to turn the individual company into a limited company, going on with the manufacturing of "composite material" outdoor lighting fixtures. The articles range increased thanks to the creation of many new models and the production capacity was multiplied by the use of computerized machineries. The recent settlement in the new company seat had definitively made Fumagalli S.r.l. a worldwide leading company in the manufacturing of resin material outdoor lightings.

*Subentrando alla ditta individuale, la famiglia Fumagalli decide di costituirsi in società, continuando la fabbricazione di lampade da esterno in materiale composito. Con la creazione di nuovi modelli viene ampliata l'offerta e con attrezzature robotizzate viene moltiplicata la produttività. La sistemazione nella nuova sede rende la società Fumagalli leader mondiale nel suo settore.*

2001  
2002  
2003  
2004  
2005  
2006  
2007  
2008  
2009  
2010  
2011  
2012  
2013  
2014  
2015  
2016

2017

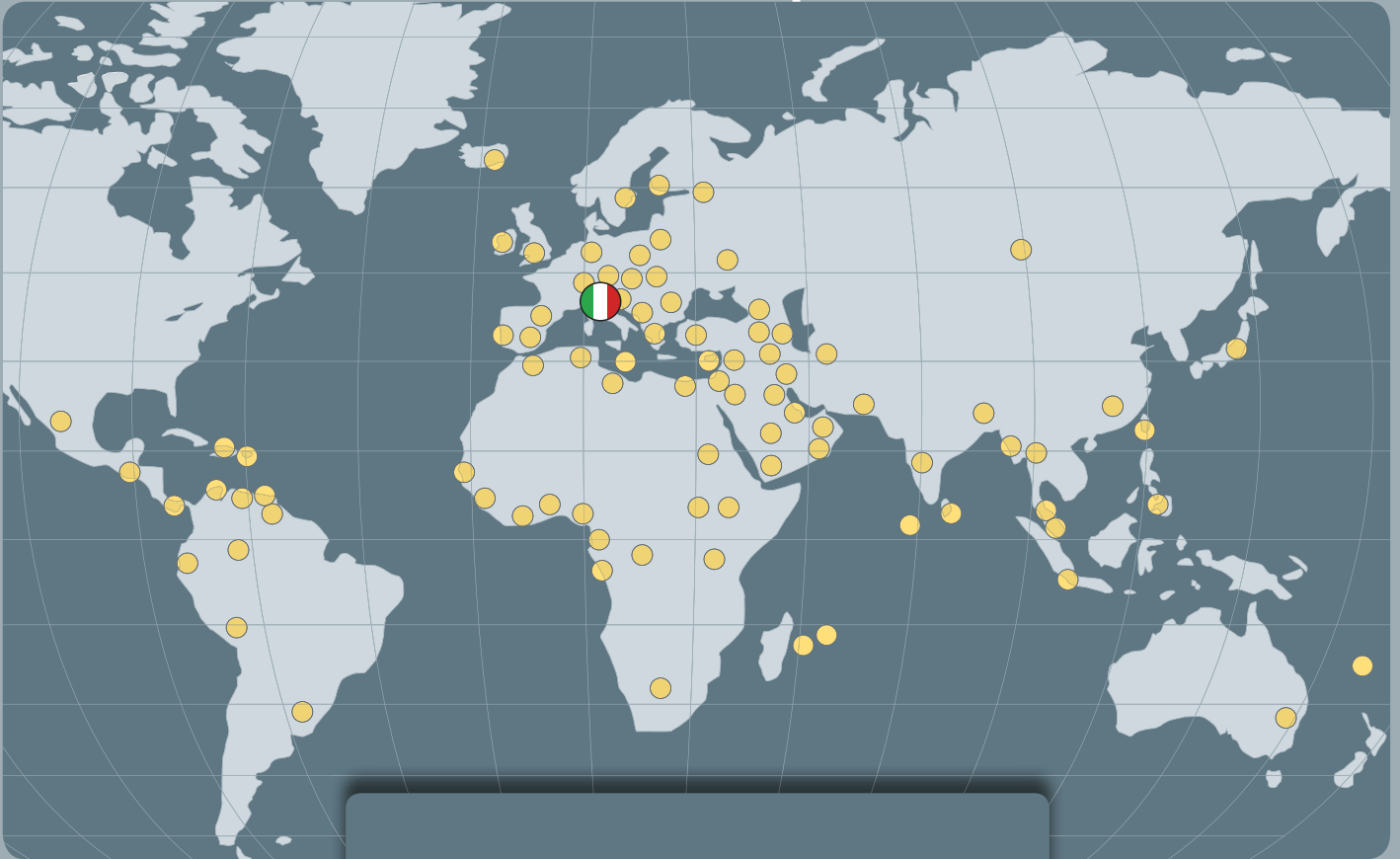

**117**  
DISTRIBUTORS ALL  
OVER THE WORLD



**MADE IN ITALY**

LAMPS  
POST  
HIGH-BAY  
URBAN MODERN  
URBAN CLASSIC  
GARDEN  
BOLLARDS  
BRICKLIGHT  
IN-GROUND  
FLOODLIGHT  
BULKHEAD

## COMPANY PLANT



We are proud to define ourselves as a “pure Italian manufacturer”: all our products are strictly manufactured inside our factory located in Varese (Italy), enabling us to have a full control about the quality and performance of our products.

*Siamo orgogliosi di poterci definire come fabbricanti italiani “puri”: tutti i nostri prodotti sono rigorosamente fabbricati all’interno dei nostri stabilimenti di Varese (Italia), permettendoci così di esercitare un pieno controllo sulla qualità e sulle prestazioni dei nostri prodotti.*



## FACTORY





Member of  
CONFEDERATION OF  
ITALIAN INDUSTRY  
**ISO 9001:2008**



ISO 9001:2008



SCESm 001



**WAREHOUSE**

BULKHEAD

FLOODLIGHT

IN-GROUND

BRICKLIGHT

BOLLARDS

GARDEN

URBAN CLASSIC

URBAN MODERN

HIGH-BAY

POST

LAMPS



## COMPANY

### PRODUCT DEVELOPMENT



Inside the following different departments of our company we can manage the whole product development process from the initial design to the fully-finished product.

*All'interno dei seguenti dipartimenti della nostra azienda possiamo gestire l'intero processo di sviluppo del prodotto, dall'idea iniziale al prodotto realizzato.*

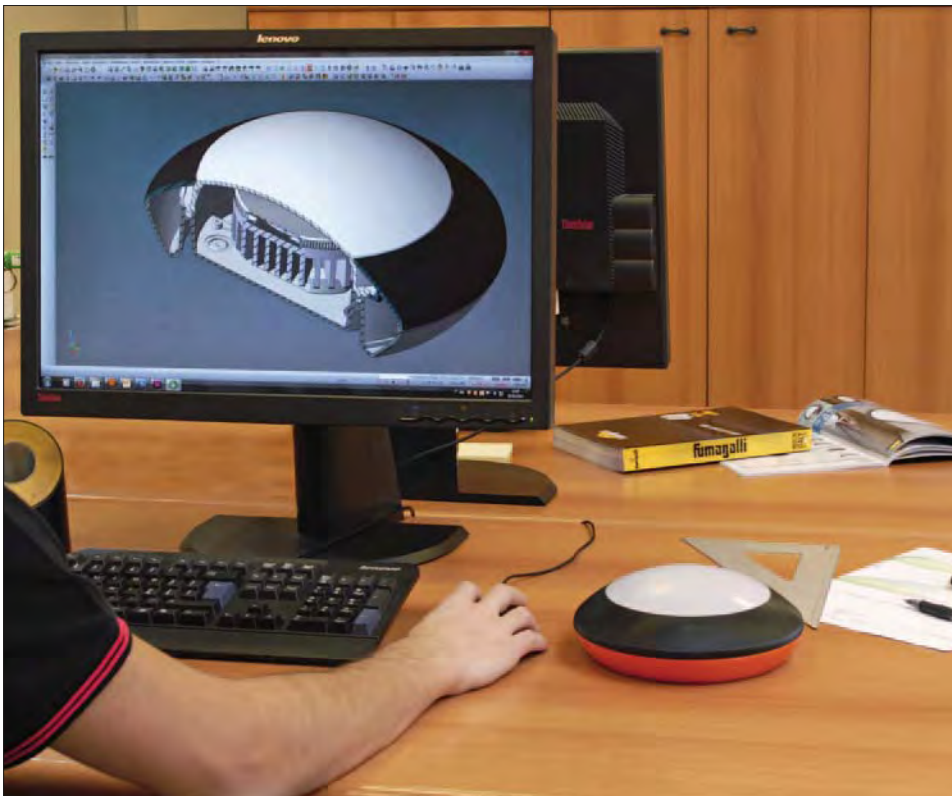

#### RESEARCH & DEVELOPMENT DEPARTMENT

Product planning and design through the most advanced 3D modelling software, CAD systems and modern multimedia. Product engineering and prototypes creation with the most advanced technological facilities.

#### SEZIONE RICERCA E SVILUPPO

*Progettazione e disegno del prodotto attraverso i software più avanzati di modellazione 3D, di sistemi CAD e di multimedia moderni. Ingegnerizzazione del prodotto e creazione di prototipi con le più avanzate strumentazioni tecnologiche.*



#### TECHNICAL DESIGN DEPARTMENT

Mould design and engineering, toolpath programming through the most advanced 3D software directly connected to the CNC workstations.

#### SEZIONE PROGETTAZIONE STAMPI

*Progettazione e ingegnerizzazione degli stampi, studio dei percorsi utensile, attraverso i più avanzati software 3D direttamente collegati alle postazioni di lavoro CNC.*

**MOULD CONSTRUCTION DEPARTMENT**

New hi-tech work stations working only for the construction of our moulds enable us to update constantly our collection with new products manufactured in accordance with the most advanced lighting solutions. An internal mould construction division means also full control on the quality of our product in all its details and a continuous and regular maintenance of the many existing moulds.

**REPARTO COSTRUZIONE STAMPI**

*Nuovi centri di lavoro dedicati esclusivamente alla costruzione dei nostri stampi, ci permettono di aggiornare costantemente la nostra collezione con numerosi prodotti nuovi, fabbricati secondo le più moderne tecnologie e in accordo con le più recenti soluzioni illuminotecniche. Una divisione interna per la costruzione degli stampi significa anche totale controllo sulla qualità del prodotto nei suoi minimi dettagli e possibilità di effettuare una regolare e costante manutenzione sui numerosi stampi esistenti.*



BULKHEAD  
FLOODLIGHT  
IN-GROUND  
BRICKLIGHT  
BOLLARDS  
GARDEN  
URBAN CLASSIC  
URBAN MODERN  
HIGH-BAY  
POST  
LAMPS



BULKHEAD  
FLOODLIGHT  
IN-GROUND  
BRICKLIGHT  
BOLLARDS  
GARDEN  
URBAN CLASSIC  
URBAN MODERN  
HIGH-BAY  
POST  
LAMPS

**INDUSTRIAL PRODUCTION PROCESS IN DIFFERENT PHASES**

A successful synergy between the ten-year-long experience of a qualified staff and the use of modern automatic machineries with the most updated technologies.

**PROCESSO DI PRODUZIONE INDUSTRIALE IN DIVERSE FASI**

*Un'efficace sinergia tra la decennale esperienza di personale qualificato e l'utilizzo di macchinari automatici dotati delle più moderne tecnologie.*

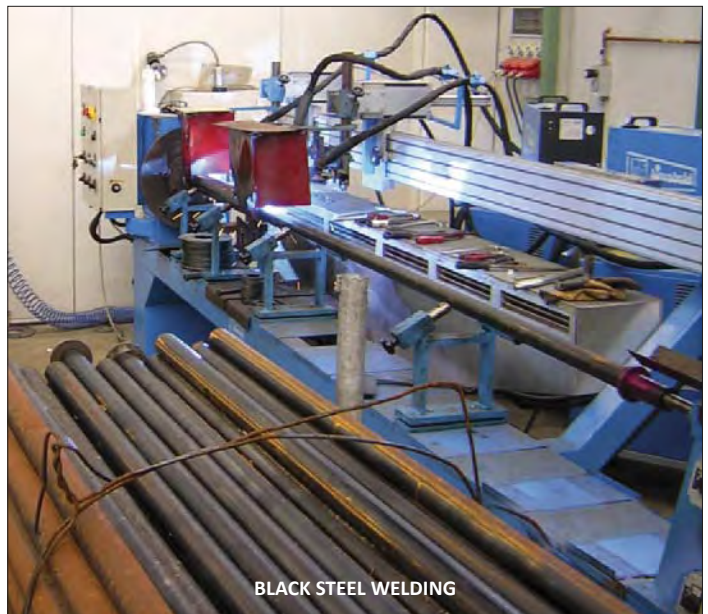

BULKHEAD  
FLOODLIGHT  
IN-GROUND  
BRICKLIGHT  
BOLLARDS  
GARDEN  
URBAN CLASSIC  
URBAN MODERN  
HIGH-BAY  
POST  
LAMPS

**WAREHOUSE**

Fumagalli stock of raw materials components and semi-finished products is maintained at the best levels to ensure prompt delivery of standard products and fast preparation of special or large quantity orders.

**MAGAZZINO**

*Lo stock Fumagalli di materie prime, componenti e semi-lavorati viene mantenuto a livelli ottimali per assicurare pronte consegne dei prodotti standard ed una veloce esecuzione di richieste speciali o per grandi quantità.*



**COMPONENTS STOCK**



BULKHEAD

FLOODLIGHT

IN-GROUND

BRICKLIGHT

BOLLARDS

GARDEN

URBAN CLASSIC

URBAN MODERN

HIGH-BAY

POST

LAMPS

**READY POLES STOCK**

**Stock for projects poles to ensure quick deliveries**

3200 poles 2,5mt, 3mt, 4mt, 5mt high - Colours: Classic poles in black. Modern poles in grey.



**ASSEMBLY AND  
ELECTRIFICATION dept.**

The assembly, electrification and packing department allows us to ship the products ready for installation to meet customer's needs.

**REPARTO DI  
ASSEMBLAGGIO  
ED ELETTTRIFICAZIONE**

*Il reparto di assemblaggio, elettrificazione ed imballaggio ci consente di spedire i nostri prodotti già pronti per l'installazione e personalizzati secondo le necessità del cliente.*



BULKHEAD  
FLOODLIGHT  
IN-GROUND  
BRICKLIGHT  
BOLLARDS  
GARDEN  
URBAN CLASSIC  
URBAN MODERN  
HIGH-BAY  
POST  
LAMPS



BOX STOCK



PACKING



GOODS READY FOR SHIPMENT



BULKHEAD

FLOODLIGHT

IN-GROUND

BRICKLIGHT

BOLLARDS

GARDEN

URBAN CLASSIC

URBAN MODERN

HIGH-BAY

POST

LAMPS



Fumagalli **created** and developed a unique post technology, registered as **FUMATECH**. Fumatech technology grants to our lamps the same strength features of a metal post, combined with all the advantages in terms of rust and corrosion resistance that only a resin material can offer.

L'azienda Fumagalli ha **creato** e sviluppato un'esclusiva tecnologia per la fabbricazione dei pali, registrata come **FUMATECH**. La tecnologia FUMATECH assicura alle nostre lampade le medesime caratteristiche di solidità di un palo in metallo, con tutti i vantaggi in termini di resistenza alla ruggine e alla corrosione che solo la resina può offrire.



**44 YEARS  
EXPERIENCE**

## METAL POST COVERED BY RESIN

- ✓ Protected against corrosion.  
*Inattaccabile dalla corrosione.*
- ✓ Not-fading colours (UV-rays stabilized).  
*Colori inalterati nel tempo (stabilizzati ai raggi UV).*
- ✓ Double insulated.  
*Doppio isolamento.*
- ✓ Rigid and shockproof.  
*Rigido e resistente agli urti.*
- ✓ Fireproof.  
*Ignifugo.*
- ✓ Light and easy to transport.  
*Leggero e facile da trasportare.*
- ✓ Manufactured according to European Community's standards.  
*Fabbricato secondo le norme della Comunità Europea.*
- ✓ High quality resin polymer sourced in Europe.  
*Resina polimerica di alta qualità fabbricata in Europa.*



### 1 INNER METAL POLE STRUCTURE

Structural metal pole hot deep galvanized inside and outside by zinc bath immersion.

### 2 OUTER RESIN COVER

Outer coating of a **single piece without joints** made of shockproof resin material:

- Rust and corrosion-free
- Paste molded colors, UV stabilized
- Self-extinguishing on fire

### 3 EXPANSE

High Density rigid polyurethane provides lightweight and durable cohesion between the inner metal post and the outer resin cover.



**MADE IN ITALY**



### ANTI CORROSION

Thanks to the outer resin material, Fumagalli lamps are protected against rust and corrosion, even if subjected to saline or polluted environments. *Grazie alla resina esterna le lampade Fumagalli sono protette da ruggine e corrosione, anche se esposte ad ambienti salini o inquinati.*



### NO MAINTENANCE

The colour of the outer resin coating is molded in the paste of material to grant the maximum durability over the time. No re-painting will ever be necessary. *Il colore della resina esterna è nella pasta stessa del materiale, per garantire la massima durata nel tempo. Non sarà più necessaria alcuna riverniciatura.*



### UV-RAYS STABILIZED

Fumagalli products are made of UV stabilized materials to avoid color fading of the outer surface under the sun. Ideal in hot and cold climate. *I prodotti Fumagalli sono realizzati con materiali stabilizzati agli UV per evitare che il colore della superficie esterna sbiadisca con il sole.*



### SAFE



CLASS II

The outer resin coating of Fumagalli products isolates the lamp from electrical discharges (double insulation Class II).

*Il rivestimento esterno dei prodotti Fumagalli rende la lampada isolata dalle scariche elettriche (doppio isolamento Classe II).*



### UNAFFECTED BY CHEMICAL FERTILIZERS

Fumagalli lamps are not affected by chemical fertilizer or pollutants.

*Le lampade Fumagalli non sono soggette a deterioramento dovuto a fertilizzanti chimici od agenti inquinanti.*



# ISO 9001:2008

In order to assure the reliability of its manufacturing and marketing process, the company Fumagalli Srl has implemented and maintains a management system, which meets the requirements of the standard **ISO 9001:2008**, as certified by The International Certification Network **IQNET**, which is the largest provider of management system certification in the world, and by the Swiss Association for Quality and Management Systems **SQS**.

*Per garantire l'affidabilità del proprio processo produttivo e commerciale, la ditta Fumagalli Srl possiede e mantiene un sistema di gestione aziendale che soddisfa i requisiti della norma **ISO 9001:2008**, come certificato sia dall'International Certification Network **IQNET**, che è il più grande organismo al mondo preposto a certificare sistemi di gestione per la qualità, sia dall'Associazione Svizzera per Sistemi di Qualità e di Management **SQS**.*



Fumagalli products obtained also the C-UL-US certification Mark, as they meet the United States National Standard for Luminaires UL1598 and the Canadian National Standard for Luminaires CSA C22.2 No. 250.0.

Fumagalli company is officially registered as a UL classified manufacturer and, upon request, a copy of the UL Certificate of Compliance can be provided to Fumagalli customers, together with the report about the following tests conducted on Fumagalli products: Grounding Continuity Test, Normal Temperature Test, Dielectric Voltage-Withstand Test, Rain Test, Sprinkler Test.

*I prodotti Fumagalli hanno ottenuto in via definitiva anche la certificazione C-UL-US, essendo conformi agli standard statunitensi UL1598 per apparecchi illuminanti e agli standard canadesi CSA C22.2 No. 250.0.*

*La ditta Fumagalli è stata ufficialmente registrata all'interno dell'albo dei fabbricanti certificati UL e, su richiesta, una copia del certificato di conformità UL può essere fornito a tutti i clienti Fumagalli, insieme con i report dei seguenti test condotti sui prodotti Fumagalli: Grounding Continuity Test, Normal Temperature Test, Dielectric Voltage-Withstand Test, Rain Test, Sprinkler Test.*



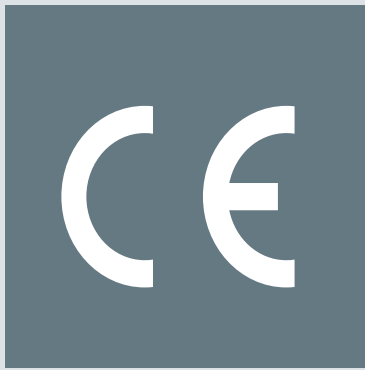

All Fumagalli products are manufactured according to the most updated international standards and regulation and are CE marked in order to ensure to our worldwide customers the highest levels of quality in the full respect of environment and person.

*Tutti i prodotti Fumagalli sono fabbricati secondo le più aggiornate norme e standard internazionali e sono marcati CE, in modo da assicurare ai nostri clienti in tutto il mondo i più alti livelli di qualità nel pieno rispetto dell'ambiente e delle persone.*



With the aim of offering to our customers very reliable and safe LED solutions with certified quality and certified performances, all Fumagalli **LED lamps** (GX53, GU10, E27) obtained the prestigious **TÜV SÜD German certification mark**, which includes the following certifications:

- **TÜV Certificate of Compliance:** Fumagalli lamps comply with the international standards EN 60968/A2:1999, EN 62031:2008, EN 62471:2008, IEC 62560:2011, EN 62493:2010.
- **EMC Certificate:** Fumagalli lamps meet the Electromagnetic Compatibility Directive 2004/108/EC
- **LVD Certificate:** Fumagalli lamps fulfil the Low Voltage Directive 2006/95 /EC, therefore are CE marked and comply with safety requirements like protection against electrical shock, moisture and heat resistance, resistance to flame and ignition.
- **ERP Attestation of conformity:** Fumagalli lamps fulfil the European Ecodesign Directive 2009/125/EC about the energy performance requirements of energy related products.

Al fine di offrire ai nostri clienti soluzioni a Led affidabili e sicure con qualità e prestazioni certificate, tutte le **lampadine a LED** Fumagalli (GX53, GU10, E27) hanno ottenuto la prestigiosa certificazione TÜV SÜD, che comprende le seguenti certificazioni:

- **Certificato di Conformità TÜV:** le lampadine Fumagalli sono conformi ai seguenti standard internazionali: EN 60968/A2:1999, EN 62031:2008, EN 62471:2008, IEC 62560:2011, EN 62493:2010.
- **Certificato EMC:** le lampadine Fumagalli rispettano la Direttiva di Compatibilità Elettromagnetica 2004/108/EC.
- **Certificato LVD:** le lampadine Fumagalli rispettano la Direttiva Bassa Tensione 2006/95 /EC, sono perciò marchiate CE e conformi a requisiti di sicurezza quali protezione contro scosse elettriche, resistenza al calore e all'umidità, resistenza alla fiamma e alle accensioni.
- **Certificato di Conformità ERP:** le lampadine Fumagalli sono conformi alla Direttiva europea 2009/125/EC sulla progettazione ecocompatibile che stabilisce i requisiti di prestazione energetica (ERP) dei prodotti connessi all'energia.





A specialized team of lighting professionals is permanently at our customers' disposal to provide a qualified product technical support, to supply lighting diagrams and to give advice about the optimal article selection and light sources distribution, according to the customer's needs.

In addition, our technical division can provide at any time the following information and services to our worldwide customers:

- **photometric data** for all Fumagalli diffusers with different wattages: they are available on request in eulumdat, iesna 86/91/95, cibse\1, ltl
- **calculation of the average horizontal luminance** and of the isolux curves at a given high level
- **wind load calculations**

From Fumagalli web site [www.fumagalli.it](http://www.fumagalli.it) it's possible to download the technical specification and the photometric data in .eulumdat or .ies format of all Fumagalli luminaries.

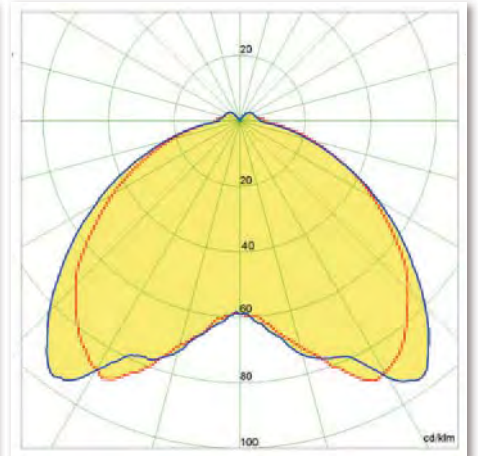
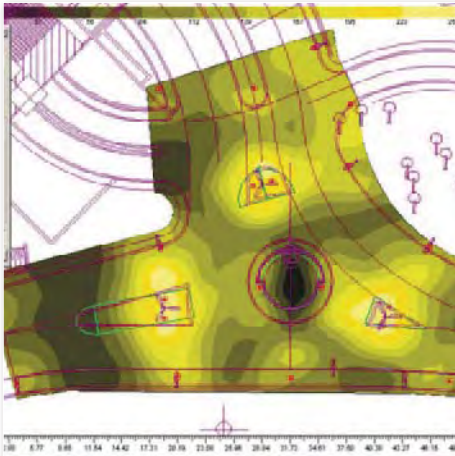

*Un team dedicato di professionisti della luce è permanentemente a disposizione dei nostri clienti per fornire un qualificato supporto tecnico relativo al prodotto, per elaborare studi fotometrici e per fornire consigli sulle soluzioni ottimali relative alla selezione degli articoli e alla distribuzione delle sorgenti luminose in una data area. In aggiunta, il nostro dipartimento tecnico può fornire in ogni momento ai nostri clienti in tutto il mondo le seguenti informazioni e servizi:*

- **dati fotometrici** di tutti i diffusori Fumagalli con diversi wattaggi: questi sono disponibili su richiesta nei formati eulumdat, iesna 86/91/95, cibse\1, ltl
- **calcolo dell'illuminamento** medio orizzontale e delle curve isolux ad una data altezza
- **calcoli relativi alla resistenza al vento**

*È possibile scaricare dal sito Fumagalli [www.fumagalli.it](http://www.fumagalli.it) le schede tecniche e le fotometrie di tutti i diffusori Fumagalli in formato .eulumdat o .ies.*

catalogue  
INDEX

product  
NAME

PHOTO  
suggested  
application

CURRENT  
SECTION

category  
NAME

PACKAGING  
DETAILS

CODE  
NUMBER

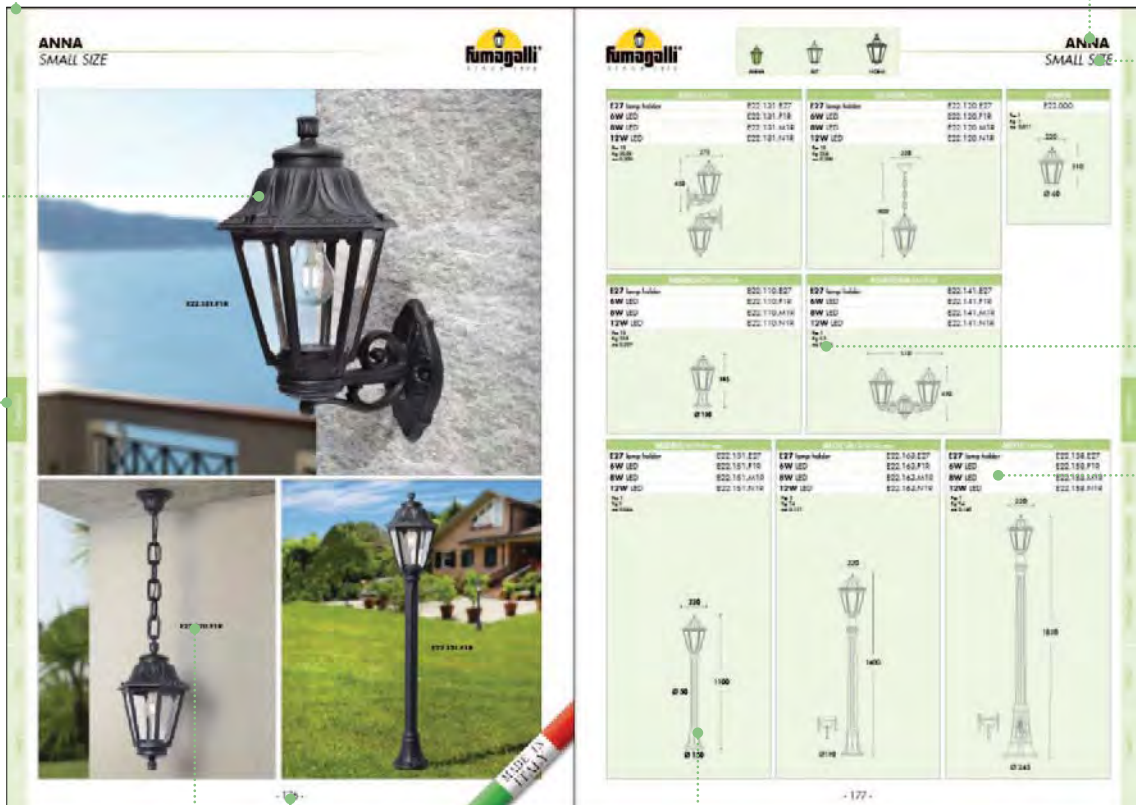

CODE  
NUMBER

PAGE  
NUMBER

FIXTURE SIZE  
AND DRAWINGS

## HOW TO READ THE CODES

IDENTIFIES THE COLOUR OF THE STRUCTURE

IDENTIFIES THE COLOUR OF THE  
DIFFUSER OR THE GLOBE

IDENTIFIES THE **STRUCTURE**  
ON WHICH THE DIFFUSER IS  
MOUNTED (POLE, BRACKET, BASE)

BLACK **A**  
WHITE **W**  
GREY **L**  
ANTIQUE GREEN\* **V**  
ANTIQUE BRONZE\* **B**

**X** CLEAR / FROSTED  
**Y** OPAL (milky white)  
**Z** SMOKED (for globes only)  
**N** GREEN  
**R** ORANGE  
**U** BLUE

**Q 4 3**

**2 2 3**

**N 4 0**

**V**

**Y**

**S 7 0**

**F C 6**

IDENTIFIES  
THE **DIFFUSER**

IDENTIFIES THE  
MULTI-LIGHT  
SYSTEM IF PRESENT

IDENTIFIES THE TYPE OF  
**ELECTRIFICATION** AND THE  
EVENTUAL PRESENCE  
OF **LED LAMPS**

**VARIANT** - IDENTIFIES THE PRESENCE  
OF COMPONENTS SUCH AS AN  
EVENTUAL LOUVRE OR BACKLIT BASE  
ON THE BULKHEAD RANGE

\* hand-made painted colour

LAMPS	
POST	
HIGH-BAY	
URBAN MODERN	
URBAN CLASSIC	
GARDEN	
BOLLARDS	
BRICKLIGHT	
IN-GROUND	
FLOODLIGHT	
BULKHEAD	

# BULKHEAD

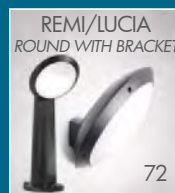
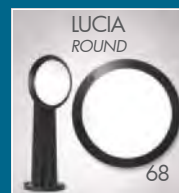
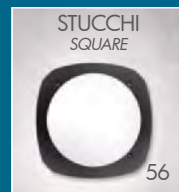
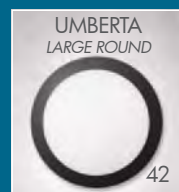
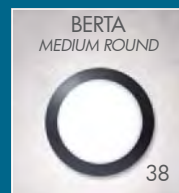
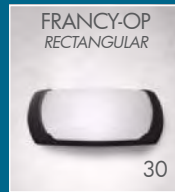

FLOODLIGHT

IN-GROUND

BRICKLIGHT

BOLLARDS

GARDEN

URBAN CLASSIC

URBAN MODERN

HIGH-BAY

POST

LAMPS



**UP & DOWN**

BULKHEAD

FLOODLIGHT

IN-GROUND

BRICKLIGHT

BOLLARDS

GARDEN

URBAN CLASSIC

URBAN MODERN

HIGH-BAY

POST

LAMPS

Up&down bulkhead lamp with no visible screws made of shockproof resin material, UV-rays stabilized, rust and corrosion-free. Available with single opening for one side light emission or with double opening for up&down light emission. Supplied as standard with TÜV approved, long-life and efficient **GU10 LED lamps**. Insulation class II, Protection rating IP66.

*Plafoniera up&down senza viti a vista realizzata in resina antiurto, stabilizzata ai raggi UV, inattaccabile da ruggine e corrosione. Disponibile con apertura singola ed emissione della luce in una sola direzione o con apertura doppia ed emissione della luce up&down. Fornito nella versione standard con **inclusa lampadina a LED GU10** approvata TÜV di lunga durata ed elevata efficienza. Classe di isolamento II, grado di protezione IP66.*

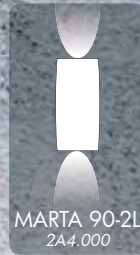

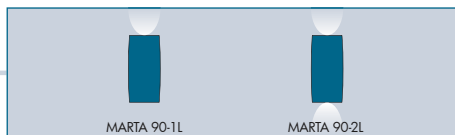

**MARTA 90 - COMPONENTS**

**IP55**



**BODY** with no visible screws made of shockproof resin material, UV-rays stabilized, rust and corrosion free. Available with double openings for up&down light emission or with single opening for one side light emission.

**CORPO** senza viti a vista in resina antiurto, stabilizzata ai raggi UV, inattaccabile da ruggine e corrosione. Disponibile nella versione satinata o con apertura doppia ed emissione della luce UP&DOWN o con apertura singola ed emissione della luce in una sola direzione.

**DIFFUSER** made of shockproof resin material (PC) complete with silicone rubber gasket to ensure high protection against external agents. Frosted or coloured versions, to get a customized ambience.

**DIFFUSORE** in resina antiurto (PC) completo di guarnizione in gomma siliconica per garantire un alto livello di protezione contro gli agenti esterni. Disponibile nella versione satinata o colorata, per ottenere un'ambientazione personalizzata.



**BASE** made of shockproof resin material suitable for the electrical devices fixation and provided with single or double GU10 LED lamp included.

**BASE** in resina antiurto predisposta per il fissaggio degli accessori elettrici. Fornita completa di lampadina a LED GU10 singola o doppia.

**MARTA 90**



**Dimensions and weight**

Width: 92 mm  
Height: 170 mm  
Depth: 90 mm  
Weight: 0,5 Kg

**Moulded colours:**

Black White Grey

**Diffuser PC:**

Frosted Green Orange  
Blue

**GU10 LED**

\*ADD. SUFFIX



	<b>4,5 W</b>	<b>300 Lm</b>	4000 K .U1L
			3000 K .U1R
	<b>2x 4,5W 9 W</b>	<b>600 Lm</b>	4000 K .U2L
			3000 K .U2R

Up&down bulkhead supplied as standard with single or double TÜV approved long-life and efficient **GU10 LED lamp included**. Quick and easy lamp replacement for a very simple maintenance after installation.

- **COST SAVING:** long-life and efficient LED light sources.
- **BUILT-IN DRIVER:** quick and easy lamp replacement.
- **GREAT FLEXIBILITY:** GU10 standard lamp holder.
- **FUTURE-PROOFED LUMINARIES:** performances easy to upgrade to latest technology developments.
- **SUITABLE FOR OUTDOOR USE:** built-in driver fully protected against heat and humidity by silicone paste.



**LED LAMPS**



More technical details about TÜV approved Fumagalli LED Lamps on page 468.

\*ADD THESE SUFFIXES TO THE REFERENCES MENTIONED IN THE CATALOGUE

# MARTA 90

UP & DOWN

BULKHEAD

FLOODLIGHT

IN-GROUND

BRICKLIGHT

BOLLARDS

GARDEN

URBAN CLASSIC

URBAN MODERN

HIGH-BAY

POST

LAMPS



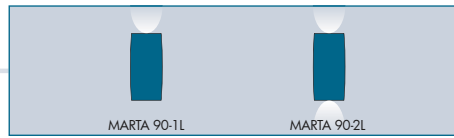

MARTA 90-1L		
1A4.000.U1L	<b>4,5W</b>	1A4.000.U1R
4000K	GU10 LED LAMP INCLUDED	3000K
Pcs 36 Kg 20 mc 0,12		

MARTA 90-2L		
2A4.000.U2L	<b>9W</b>	2A4.000.U2R
4000K	2 GU10 LED LAMPS INCLUDED	3000K
Pcs 36 Kg 20 mc 0,12		

BULKHEAD

FLOODLIGHT

IN-GROUND

BRICKLIGHT

BOLLARDS

GARDEN

URBAN CLASSIC

URBAN MODERN

HIGH-BAY

POST

LAMPS

# FRANCY

## UP & DOWN

Bulkhead lamp with no visible screws and UP&DOWN light emission. Made of shockproof resin material, UV-rays stabilized, rust and corrosion-free. Supplied with **E27** lampholder, available with TÜV approved, long-life and efficient **LED filament lamps** suitable for outdoor use. Version with motion sensor available. Insulation class II, Protection rating IP66.



*Plafoniera senza viti a vista con emissione della luce UP&DOWN. Realizzata in resina antiurto, stabilizzata ai raggi UV, inattaccabile da ruggine e corrosione. Fornita con portalampada E27 e disponibile con lampadine LED a filamento adatte ad uso in ambiente esterno, approvate TÜV, di lunga durata ed elevata efficienza. Disponibile anche con sensore di movimento. Classe di isolamento II, grado di protezione IP66.*



1A1.000.F1R



MADE IN ITALY

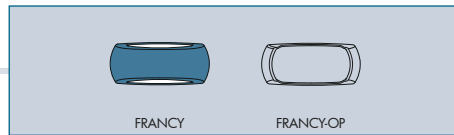

**FRANCY - COMPONENTS**

IP 66



**COVER** with no visible screws made of shockproof resin material UV-rays stabilized. Designed for getting UP&DOWN or side light emission.

**COVER** senza viti a vista realizzata in resina antiurto, stabilizzata ai raggi UV. Disegnata per ottenere un'emissione laterale della luce.

**DIFFUSER** made of UV-rays stabilized polymethylmethacrylate (PMMA) screwed to the bulkhead base.

**DIFFUSORE** realizzato in polimetilmetacrilato (PMMA) stabilizzato ai raggi UV da avvitare alla base della plafoniera.

**BASE** made of shockproof resin material, UV-rays stabilized, suitable for the electrical devices fixation. Provided with E27 lampholder and with silicone rubber gasket to ensure high protection against external agents.

**BASE** realizzata in resina antiurto, stabilizzata ai raggi UV, adatta ad alloggiare gli accessori elettrici. Fornita completa di portalampana E27 e di guarnizione in gomma siliconica per garantire un alto livello di protezione contro gli agenti esterni.

**FRANCY**



**Dimensions and weight**

Width: 130 mm  
Height: 300 mm  
Depth: 90 mm  
Weight: 1 Kg

**Moulded Colours:**

Black  Grey  White

**Diffuser PC:**

Opal  Frosted (upon request)

**E27**

FULLY PRE-WIRED



Bulkhead supplied **fully pre-wired** with E27 lampholder. Provided as an option with TÜV approved, long-life and efficient **LED filament lamps** suitable for outdoor use with driver fully protected against heat and humidity by silicone paste.

\*ADD. SUFFIX

**E27 with sensor**

FULLY PRE-WIRED



Bulkhead supplied **fully pre-wired** with E27 lampholder and **LED filament lamps** as an option. Complete with microwave daylight and motion **sensor**. Sensor operating voltage: 220-240V. (120V version available on demand).

\*ADD. SUFFIX

**LED LAMPS**



More technical details about TÜV approved Fumagalli LED Lamps on page 468.

E27 (CFL-LED)		max 160 mm		.E27
	6 W	800 Lm	2700 K	.F1R
	8 W	1000 Lm	2700 K	.M1R
	12 W	1500 Lm	2700 K	.N1R

E27 (CFL-LED)		max 160 mm		.ES7
	6 W	800 Lm	2700 K	.S1R
	8 W	1000 Lm	2700 K	.T1R
	12 W	1500 Lm	2700 K	.V1R

\* ADD THESE SUFFIXES TO THE REFERENCES MENTIONED IN THE CATALOGUE

6W  
8W  
12W = 60W  
75W  
100W incandescent

**SAVE 90%**

6W  
8W  
12W = 60W  
75W  
100W incandescent

**SAVE 90%**

# FRANCY-OP

## RECTANGULAR

BULKHEAD

FLOODLIGHT

IN-GROUND

BRICKLIGHT

BOLLARDS

GARDEN

URBAN CLASSIC

URBAN MODERN

HIGH-BAY

POST

LAMPS

Bulkhead lamp with no visible screws and front light emission. Made of shockproof resin material, UV-rays stabilized, rust and corrosion-free. Suitable for wall and ceiling installation. Complete with TÜV approved, long-life and efficient **GX53 LED lamps included** or provided with **E27** lampholder. Version with motion sensor available. Insulation class II, Protection rating IP66.



*Plafoniera senza viti a vista con emissione della luce frontale. Realizzata in resina antiurto stabilizzata ai raggi UV, inattaccabile da ruggine e corrosione. Idonea per il montaggio a parete e a soffitto. Completa di lampadine a LED GX53 approvate TÜV di lunga durata ed elevata efficienza o fornita nella versione E27. Disponibile anche con sensore di movimento. Classe di isolamento II, grado di protezione IP66.*



2A1.000

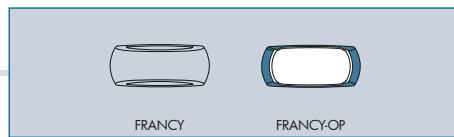

**FRANCY-OP - COMPONENTS**

IP 66



**COVER** with no visible screws made of shockproof resin material UV-rays stabilized. Designed for getting front light emission.

*COVER senza viti a vista realizzata in resina antiurto, stabilizzata ai raggi UV. Disegnata per ottenere un'emissione frontale della luce.*



**DIFFUSER** made of UV-rays stabilized polymethylmethacrylate (PMMA) screwed to the bulkhead base.

*DIFFUSORE realizzato in polimetilmetacrilato (PMMA) stabilizzato ai raggi UV da avvitare alla base della plafoniera.*



**BASE** made of shockproof resin material, UV-rays stabilized, suitable for the electrical devices fixation. Provided with E27 or with 2x GX53 lampholders and complete with silicone rubber gasket to ensure high protection against external agents.

*BASE realizzata in resina antiurto, stabilizzata ai raggi UV, adatta ad alloggiare gli accessori elettrici. Fornita completa di portalampada E27 o di 2 portalampada GX53. Completa di guarnizione in gomma siliconica per garantire un alto livello di protezione contro gli agenti esterni.*

**FRANCY-OP**



**Dimensions and weight**

Width: 130 mm  
Height: 300 mm  
Depth: 90 mm  
Weight: 1 Kg

**Moulded Colours:**

Black  Grey  White

**Diffuser PC:**

Opal  Frosted (upon request)

**LED LAMPS**



More technical details about TÜV approved Fumagalli LED Lamps on page 468.

**GX53 LED**



Bulkhead supplied **fully pre-wired** complete with TÜV approved long-life and efficient **GX53 LED lamps 2x 3W-700lm included**. Quick and easy lamp replacement for a very simple maintenance after installation.

	2x 3W 6 W	700 Lm	4000 K	G2L
			3000 K	.G2R

2x 3W 700 Lm = 60W incandescent

**SAVE 92%**

**E27**



Bulkhead supplied **fully pre-wired** with E27 lampholder. Provided as an option with TÜV approved, long-life and efficient **LED filament lamps** suitable for outdoor use with driver fully protected against heat and humidity by silicone paste.

<b>E27 (CFL-LED)</b>	max 160 mm			.E27
	6 W	800 Lm	2700 K	.F1R
	8 W	1000 Lm	2700 K	.M1R
	12 W	1500 Lm	2700 K	.N1R

6W 8W 12W = 60W 75W 100W incandescent

**SAVE 90%**

**E27 with sensor**



Bulkhead supplied **fully pre-wired** with E27 lampholder and **LED filament lamps** as an option. Complete with microwave daylight and motion **sensor**. Sensor operating voltage: 220-240V. (120V version available on demand).

<b>E27 (CFL-LED)</b>	max 160 mm			.E27
	6 W	800 Lm	2700 K	.S1R
	8 W	1000 Lm	2700 K	.T1R
	12 W	1500 Lm	2700 K	.V1R

6W 8W 12W = 60W 75W 100W incandescent

**SAVE 90%**

\* ADD THESE SUFFIXES TO THE REFERENCES MENTIONED IN THE CATALOGUE



**FRANCY RANGE**  
*UP&DOWN*

BULKHEAD

FLOODLIGHT

IN-GROUND

BRICKLIGHT

BOLLARDS

GARDEN

URBAN CLASSIC

URBAN MODERN

HIGH-BAY

POST

LAMPS



MADE IN  
ITALY

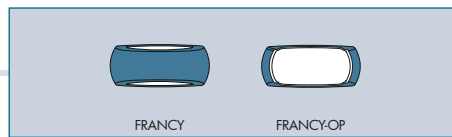

**FRANCY**

<b>E27</b> lampholder	1A1.000.E27
<b>E27</b> lampholder with sensor	1A1.000.ES7
<b>6W</b> LED filament	1A1.000.F1R
<b>8W</b> LED filament	1A1.000.M1R
<b>12W</b> LED filament	1A1.000.N1R

Pcs 24  
Kg 25  
mc 0,12

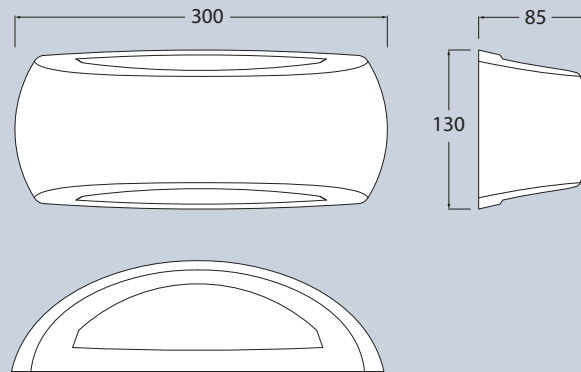

**FRANCY-OP**

<b>E27</b> lampholder	2A1.000.E27
<b>E27</b> lampholder with sensor	2A1.000.ES7
<b>6W</b> LED filament	2A1.000.F1R
<b>8W</b> LED filament	2A1.000.M1R
<b>12W</b> LED filament	2A1.000.N1R

Pcs 24  
Kg 25  
mc 0,12

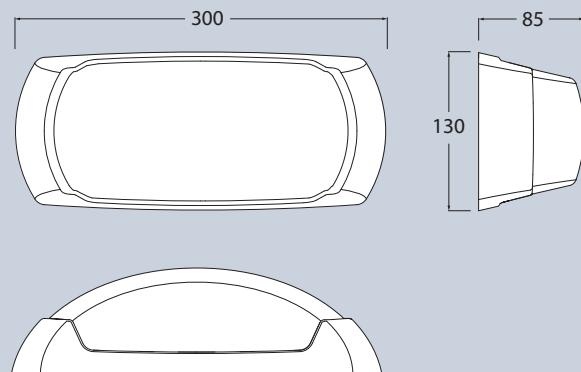

4000K

3000K

2A1.000.G2L

**2x 3W** GX53 LED

2A1.000.G2R

# BERTINA

## SMALL ROUND

LED bulkhead lamp with round shape and **no visible screws**. Made of shockproof resin material, UV-rays stabilized, rust and corrosion-free. Suitable for wall and ceiling installation. Complete with TÜV approved, long-life and efficient **GX53 LED** lamp in different wattages. Insulation class II, Protection rating IP66.



BERTINA  
1B1.000

*Plafoniera circolare a LED senza viti a vista. Realizzata in resina antiurto stabilizzata ai raggi UV, inattaccabile da ruggine e corrosione. Idonea per il montaggio a parete e a soffitto. Completa di lampadina a LED GX53 approvata TÜV, di lunga durata ed elevata efficienza, disponibile in diverse potenze. Classe di isolamento II, grado di protezione IP66.*



1B1.000.D1L

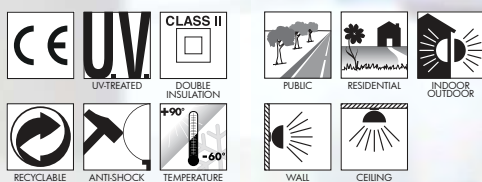

MADE IN ITALY

**BERTINA - COMPONENTS**

IP 66



**COVER with no visible screws** made of shockproof resin material, UV-rays stabilized.

**COVER senza viti a vista** realizzata in resina antiurto stabilizzata ai raggi UV.



Opal **DIFFUSER** made of UV-rays stabilized polymethylmethacrylate (PMMA) screwed to the bulkhead base.

**DIFFUSORE opale** realizzato in polimetilmetacrilato (PMMA) stabilizzato ai raggi UV da avvitare alla base della plafoniera.



**BASE** made of shockproof resin material, UV-rays stabilized, suitable for the electrical devices fixation. Provided with GX53 LED lamp TÜV approved and with silicone rubber gasket to ensure high protection against external agents.

**BASE** realizzata in resina antiurto, stabilizzata ai raggi UV, adatta ad alloggiare gli accessori elettrici. Fornita completa di lampadina LED GX53 approvata TÜV e di guarnizione in gomma silicica per garantire un alto livello di protezione contro gli agenti esterni.

**BERTINA**

— ø 200 —



**Dimensions and weight**

Diameter: ø 200 mm  
Depth: 70 mm  
Weight: 0,4 Kg

**Moulded colours:**

Black     White     Grey



**Diffuser PMMA:**

Opal

**GX53 LED**

\*ADD SUFFIX



	<b>3 W</b>	<b>350 Lm</b>	4000 K	.G1L
			3000 K	.G1R
	<b>7 W</b>	<b>800 Lm</b>	4000 K	.C1L
			3000 K	.C1R
	<b>10 W</b>	<b>1200 Lm</b>	4000 K	.D1L
			3000 K	.D1R

**LED LAMPS**



More technical details about TÜV approved Fumagalli LED Lamps on page 468.

Bulkhead supplied **fully pre-wired** complete with TÜV approved, long-life and efficient **GX53 LED** lamp in different wattages. Quick and easy lamp replacement for a very simple maintenance after installation.

- **COST SAVING:** long-life and efficient LED light sources
- **BUILT-IN DRIVER:** quick and easy lamp replacement
- **GREAT FLEXIBILITY:** GX53 standard lamp holder
- **FUTURE-PROOFED LUMINARIES:** performances easy to upgrade to latest technology developments
- **SUITABLE FOR OUTDOOR USE:** driver fully protected against heat and humidity by silicone paste.

**3W**  
350 Lm = **40W**  
incandescent

**SAVE 93%**

**7W**  
10W = **75W**  
100W  
incandescent

**SAVE 90%**

\* ADD THESE SUFFIXES TO THE REFERENCES MENTIONED IN THE CATALOGUE

**BERTINA**  
SMALL ROUND

BULKHEAD

FLOODLIGHT

IN-GROUND

BRICKLIGHT

BOLLARDS

GARDEN

URBAN CLASSIC

URBAN MODERN

HIGH-BAY

POST

LAMPS



1B1.000.D1L



1B1.000.D1L

MADE IN  
ITALY

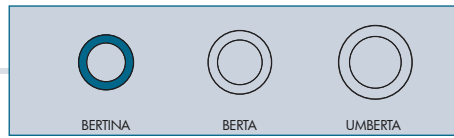

BERTINA		
1B1.000.G1L	<b>3W</b>	1B1.000.G1R
1B1.000.C1L	<b>7W</b>	1B1.000.C1R
1B1.000.D1L	<b>10W</b>	1B1.000.D1R
4000K	GX53 LED LAMP INCLUDED	3000K
Pcs 45 Kg 30 mc 0,194		

# BERTA

## MEDIUM ROUND

Round bulkhead lamp with **no visible screws**, made of shockproof resin material, UV-rays stabilized, rust and corrosion-free. Suitable for wall and ceiling installation. **GX53 LED** or **E27** version available. Insulation class II, Protection rating IP66.

*Plafoniera circolare **senza viti a vista**, realizzata in resina antiurto stabilizzata ai raggi UV, inattaccabile da ruggine e corrosione. Idonea per il montaggio a parete e a soffitto. Disponibile nella versione **GX53 LED** o **E27**. Classe di isolamento II, grado di protezione IP66.*



**1B2.000**

- BULKHEAD
- FLOODLIGHT
- IN-GROUND
- BRICKLIGHT
- BOLLARDS
- GARDEN
- URBAN CLASSIC
- URBAN MODERN
- HIGH-BAY
- POST
- LAMPS

MADE IN ITALY

**BERTA - COMPONENTS**

IP 66



**COVER** with no visible screws made of shockproof resin material, UV-rays stabilized.

*COVER senza viti a vista realizzata in resina antiurto stabilizzata ai raggi UV.*

Opal **DIFFUSER** made of UV-rays stabilized polymethylmethacrylate (PMMA) screwed to the bulkhead base.

*DIFFUSORE opale realizzato in polimetilmetacrilato (PMMA) stabilizzato ai raggi UV da avvitare alla base della plafoniera.*

**BASE** made of shockproof resin material, UV-rays stabilized, suitable for the electrical devices fixation. Provided with GX53 or E27 lampholder and with silicone rubber gasket to ensure high protection against external agents.

*BASE realizzata in resina antiurto, stabilizzata ai raggi UV, adatta ad alloggiare gli accessori elettrici. Fornita completa di portalampana GX53 o E27 e guarnizione in gomma siliconica per garantire un alto livello di protezione contro gli agenti esterni.*

**BERTA**

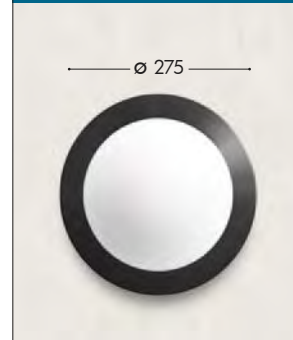

**Dimensions and weight**

Diameter:  $\varnothing$  270 mm  
Depth: 80 mm  
Weight: 0,7 Kg

**Moulded colours:**

Black     White     Grey

**Diffuser PMMA:**

Opal

**GX53 LED**



Bulkhead supplied **fully pre-wired** and complete with TÜV approved, long-life and efficient **GX53 LED** lamp in different wattages.

- **BUILT-IN DRIVER:** Quick and easy lamp replacement for a very simple maintenance after installation.
- **SUITABLE FOR OUTDOOR USE:** built-in driver fully protected against heat and humidity by silicone paste.

\*ADD. SUFFIX

	<b>11 W</b>	<b>1300 Lm</b>	4000 K	.B1L
			3000 K	.B1R
	<b>18 W</b>	<b>2000 Lm</b>	4000 K	.E1L
			3000 K	.E1R



**11W**  
**18W** = **100W**  
**150W**  
incandescent

**SAVE 90%**

**E27**



Bulkhead supplied **fully pre-wired** with E27 lampholder and complete with highly heat resistant reflective plate made of white shockproof resin material, UV-rays stabilized.

\*ADD. SUFFIX

<b>E27</b> (CFL-LED)	max 160 mm	.P27
-------------------------	------------	------

**LED LAMPS**



More technical details about TÜV approved Fumagalli LED Lamps on page 468.

\* ADD THESE SUFFIXES TO THE REFERENCES MENTIONED IN THE CATALOGUE



**BERTA**  
MEDIUM ROUND

BULKHEAD

FLOODLIGHT

IN-GROUND

BRICKLIGHT

BOLLARDS

GARDEN

URBAN CLASSIC

URBAN MODERN

HIGH-BAY

POST

LAMPS

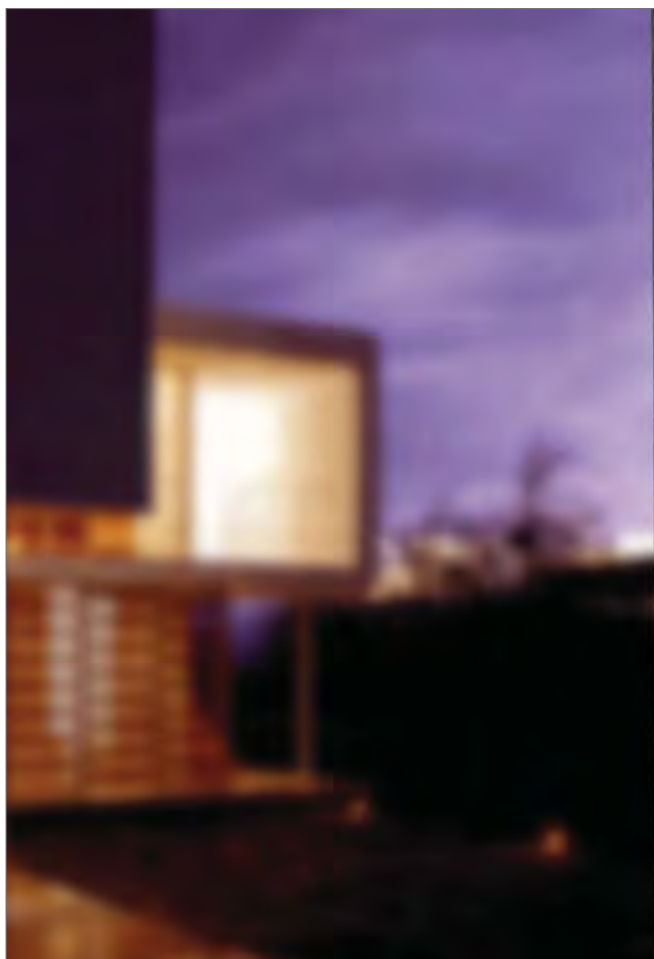

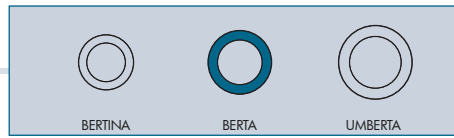

BERTA GX53		
1B2.000.B1L	<b>11W</b>	1B2.000.B1R
1B2.000.E1L	<b>18W</b>	1B2.000.E1R
4000K	GX53 LED LAMP INCLUDED	3000K
Pcs 16 Kg 18 mc 0,194		

BERTA E27	
1B2.000.P27	
Pcs 16 Kg 18 mc 0,194	

# UMBERTA

## LARGE ROUND

Round bulkhead lamp with **no visible screws**. Made of shockproof resin material, UV-rays stabilized, rust and corrosion-free. Suitable for wall and ceiling installation. **GX53 LED** or **2xE27** version available. Provided as option with motion sensor or emergency kit. Insulation class II, Protection rating IP66.



*Plafoniera circolare **senza viti a vista**, realizzata in resina antiurto stabilizzata ai raggi UV, inattaccabile da ruggine e corrosione. Idonea per il montaggio a parete e a soffitto. Disponibile nella versione a **LED GX53** o **2xE27**. Fornita anche con sensore o kit d'emergenza. Classe di isolamento II, grado di protezione IP66.*



1B3.000



MADE IN ITALY

### UMBERTA - COMPONENTS

IP66



**COVER** made of shockproof resin material, UV-rays stabilized, rust and corrosion free.

**COVER** in resina antiurto stabilizzata ai raggi UV inattaccabile da ruggine e corrosione.

Opal **DIFFUSER** made of UV-rays stabilized polymethylmethacrylate (PMMA) screwed to the bulkhead base.

**DIFFUSORE** opale realizzato in polimetilmetacrilato (PMMA) stabilizzato ai raggi UV da avvitare alla base della plafoniera.

**BASE** complete with highly heat resistant **REFLECTIVE PLATE**, suitable for the electrical devices fixation. Provided with GX53 or E27 lampholder and with silicone rubber gasket to ensure high protection against external agents.

**BASE** completa di **PIATTO RIFLETTENTE** ad alta resistenza al calore, adatto ad alloggiare gli accessori elettrici. Fornita completa di portalampada GX53 o E27 e guarnizione in gomma siliconica per garantire un alto livello di protezione contro gli agenti esterni.

### UMBERTA



#### Dimensions and weight

Diameter: Ø 350 mm  
Depth: 94 mm  
Weight: 1,3 Kg

#### Moulded Colours:

Black  Grey  White

#### Diffuser PMMA:

Opal

### GX53 LED



FULLY PRE-WIRED



Bulkhead supplied **fully pre-wired** and complete with TÜV approved, long-life and efficient **GX53 LED** lamp in different wattages. Quick and easy lamp replacement for a very simple maintenance after installation.

Daylight and motion sensor available as option.

\*ADD. SUFFIX

	11 W	1300 Lm	4000 K	.B1L
			3000 K	.B1R
	18 W	2000 Lm	4000 K	.E1L
			3000 K	.E1R
	11 W	1300 Lm	4000 K	.BSL
			3000 K	.BSR
	18 W	2000 Lm	4000 K	.ESL
			3000 K	.ESR



11W  
18W

=

100W  
150W

incandescent

SAVE 90%



### E27

FULLY PRE-WIRED



Bulkhead supplied **fully pre-wired** with single or double E27 lampholder.

Daylight and motion sensor available as option. Sensor operating voltage: 220-240V. (120V version available on demand).

\*ADD. SUFFIX

E27 (CFL -LED)	.E27
2x E27 (CFL -LED)	.E28
E27 + SENSOR (CFL -LED)	.ES7
2x E27 + SENSOR (CFL -LED)	.ES8

### EMERGENCY VERSION



Detailed information on page 46

1B3.000.EM1

### LED LAMPS



More technical details about TÜV approved Fumagalli LED Lamps on page 468.

\*ADD THESE SUFFIXES TO THE REFERENCES MENTIONED IN THE CATALOGUE

**UMBERTA**  
LARGE ROUND

BULKHEAD

FLOODLIGHT

IN-GROUND

BRICKLIGHT

BOLLARDS

GARDEN

URBAN CLASSIC

URBAN MODERN

HIGH-BAY

POST

LAMPS



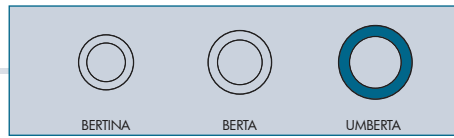

UMBERTA GX53		
1B3.000.B1L	<b>11W</b>	1B3.000.B1R
1B3.000.E1L	<b>18W</b>	1B3.000.E1R
4000K	GX53 LED LAMP INCLUDED	3000K
Pcs 12		
Kg 15		
mc 0,198		

UMBERTA E27	
1B3.000.E27	1B3.000.E28
1 X E27	2 X E27
Pcs 12	
Kg 15	
mc 0,198	

BULKHEAD

FLOODLIGHT

IN-GROUND

BRICKLIGHT

BOLLARDS

GARDEN

URBAN CLASSIC

URBAN MODERN

HIGH-BAY

POST

LAMPS

# UMBERTA EMERGENCY

## LARGE ROUND

LED MAINTAINED EMERGENCY bulkhead lamp with no visible screws. Made of shockproof resin material, UV-rays stabilized, rust and corrosion-free. Suitable for wall and ceiling installation. In case of blackout, the bulkhead switches from Normal mode to Emergency mode and keeps on working. Minimum 3 hours battery operating time. Insulation class II, Protection rating IP66.



Plafoniera a LED, RETE PIU' EMERGENZA, senza viti a vista. Realizzata in resina antiurto stabilizzata ai raggi UV, inattaccabile da ruggine e corrosione. Idonea per il montaggio a parete e a soffitto. In caso di interruzione di corrente, la plafoniera passa dalla modalità "Normale" alla modalità "Emergenza" e rimane accesa. Autonomia minima 3 ore. Classe di isolamento II, grado di protezione IP66.



1B3.000.EM1

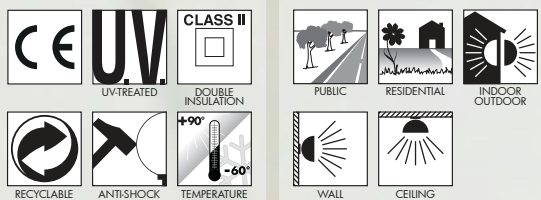

**UMBERTA EMERGENCY - COMPONENTS**

IP66

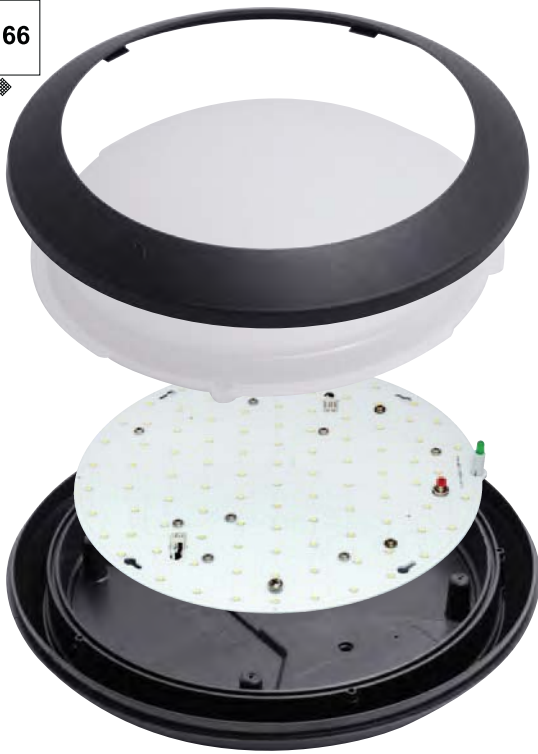

**LED Printed Circuit Board** provided with a fully-prewired **Emergency Kit**. In case of blackout the bulkhead automatically switches from Normal mode (16W - 2000 Lm) to Emergency mode (3W - 250 Lm) and keeps on working for the next 3 hours.

*Circuito stampato a LED fornito completo di kit d'emergenza pre-cablato. In caso di interruzione di corrente, la plafoniera passa dalla modalità "Normale" (16W - 2000 Lm) alla modalità "Emergenza" (3W - 250lm) e rimane accesa per 3 ore.*



**UMBERTA**

Ø 350



**Dimensions and weight**

Diameter: Ø 350 mm  
Depth: 94 mm  
Weight: 2,3 Kg

**Moulded Colours:**

Black    Grey    White

**Diffuser PMMA:**

Opal

**UMBERTA MAINTAINED EMERGENCY**

1B3.000.EM1

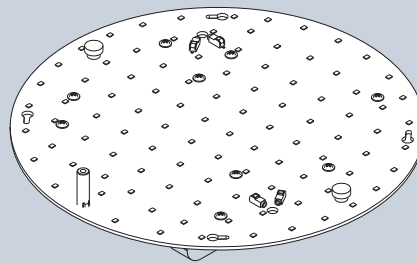
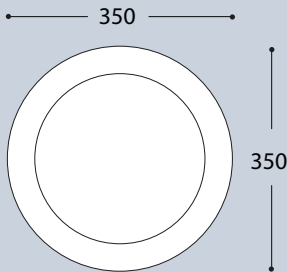

Pcs 12  
Kg 25  
mc 0,198

PRODUCT TYPE	Wall and Ceiling bulkhead with Emergency kit
OPERATING VOLTAGE	220~240 vAC
LUMINOUS FLUX & POWER	<b>1800 lumen (Normal mode), 16W</b> <b>250 lumen (Emergency mode), 3W</b>
LED TYPE	Epistar SMD 2835, 4000 K
CRI	>80Ra
PF (POWER FACTOR)	>0.9
OPERATING TEMPERATURE	0~50°C
BATTERY	Sealed NiMh Rechargeable Battery 2.0Ah 7.2V High Temp
<b>BATTERY OPERATING TIME</b>	<b>min 3 hours (250 lumen)</b>
BATTERY CHARGING TIME	24 hours
Drivers Standards	EN 61347-1, EN 61347-2-7, EN 61347-2-13, EN 62384, EN 60598-2-22 EN 55015, EN61547, EN 61000-3-2, EN 61000-3-3
Battery Standards	EN 5501-1, EN 61000, EN 55014-2

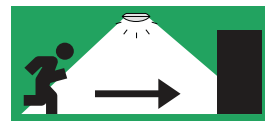

**Emergency details**



**GREEN LED**  
Identifies the emergency light and shows that the system is operating correctly.



**TEST BUTTON**  
Bulkhead provided with built-in test button to check battery status. Can be mounted also outside the fitting.



**MAINTAINED EMERGENCY**  
Normal mode:  
16W - 1800 Lm  
Emergency mode:  
3W - 250 Lm



# GELMI RANGE

## ROUND

BULKHEAD

FLOODLIGHT

IN-GROUND

BRICKLIGHT

BOLLARDS

GARDEN

URBAN CLASSIC

URBAN MODERN

HIGH-BAY

POST

LAMPS

Round bulkhead lamp with ring, eyelid or grid cover. Made of shockproof resin material, UV-rays stabilized, rust and corrosion-free. Suitable for wall and ceiling installation. **GX53 LED** or **E27** version available. Insulation class II, Protection rating IP66.

*Plafoniera circolare con cover ad anello, a palpebra o a griglia. Realizzata in resina antiurto stabilizzata ai raggi UV, inattaccabile da ruggine e corrosione. Idonea per il montaggio a parete e a soffitto. Disponibile nella versione a **LED GX53** o **E27**. Classe di isolamento II, grado di protezione IP66.*



**GELMI - COMPONENTS**

IP 66



**COVER** made of shockproof resin material, UV-rays stabilized. Ring, eyelid and grid versions available.

*COVER in resina antiurto stabilizzata ai raggi UV, disponibile nella versione ad anello, a palpebra e a griglia.*

Opal **DIFFUSER** made of UV-rays stabilized polymethylmethacrylate (PMMA), with silicone rubber gasket to ensure high protection against external agents.

*DIFFUSORE opale opale realizzato in polimetilmetacrilato (PMMA) stabilizzato ai raggi UV. Completo di guarnizione in gomma siliconica per garantire un alto livello di protezione contro gli agenti esterni.*

**BASE** made of shockproof resin material, UV-rays stabilized, suitable for the electrical devices fixation. Provided with E27 or GX53 lampholder.

*BASE realizzata in resina antiurto, stabilizzata ai raggi UV, adatta ad alloggiare gli accessori elettrici. Fornita completa di portalampana E27 o GX53.*

**GELMI**



**Dimensions and weight**

Diameter: Ø 313 mm  
Depth: 90 mm  
Weight: 1 Kg

**Moulded colours:**

Black  White  Grey

**Diffuser PMMA:**

Opal

**GX53 LED**

FULLY PRE-WIRED



Bulkhead supplied **fully pre-wired** and complete with TÜV approved, long-life and efficient **GX53 LED** lamp in different wattages.

- **BUILT-IN DRIVER:** Quick and easy lamp replacement for a very simple maintenance after installation.
- **SUITABLE FOR OUTDOOR USE:** built-in driver fully protected against heat and humidity by silicone paste.

\*ADD. SUFFIX

	11 W	1300 Lm	4000 K	.B1L
			3000 K	.B1R
	18 W	2000 Lm	4000 K	.E1L
			3000 K	.E1R

11W 18W = 100W 150W incandescent

**SAVE 90%**

**E27**

FULLY PRE-WIRED



Bulkhead supplied **fully pre-wired** with E27 lampholder and complete with highly heat resistant reflective plate made of white shockproof resin material, UV-rays stabilized.

\*ADD. SUFFIX

<b>E27</b> (CFL-LED)	max 180 mm	.E27
-------------------------	------------	------

**LED LAMPS**



More technical details about TÜV approved Fumagalli LED Lamps on page 468.

\* ADD THESE SUFFIXES TO THE REFERENCES MENTIONED IN THE CATALOGUE

**GELMI RANGE**  
**ROUND**

BULKHEAD

FLOODLIGHT

IN-GROUND

BRICKLIGHT

BOLLARDS

GARDEN

URBAN CLASSIC

URBAN MODERN

HIGH-BAY

POST

LAMPS



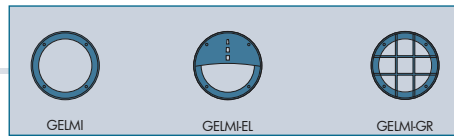

**GELMI**  
1G3.000

Pcs 16  
Kg 18  
mc 0,194

**GELMI-EL**  
2G3.000

Pcs 16  
Kg 18  
mc 0,194

**GELMI-GR**  
3G3.000

Pcs 16  
Kg 18  
mc 0,194

# DANZI RANGE

## OVAL

Oval bulkhead lamp with ring, eyelid or grid cover. Made of shockproof resin material, UV-rays stabilized, rust and corrosion-free. Suitable for wall and ceiling installation. **GX53 LED** or **E27** version available. Insulation class II, Protection rating IP66.



*Plafoniera ovale con cover ad anello, a palpebra o a griglia. Realizzata in resina antiurto stabilizzata ai raggi UV, inattaccabile da ruggine e corrosione. Idonea per il montaggio a parete e a soffitto. Disponibile nella versione a **LED GX53** o **E27**. Classe di isolamento II, grado di protezione IP66.*



1D3.000

MADE IN ITALY

BULKHEAD  
FLOODLIGHT  
IN-GROUND  
BRICKLIGHT  
BOLLARDS  
GARDEN  
URBAN CLASSIC  
URBAN MODERN  
HIGH-BAY  
POST  
LAMPS

**DANZI - COMPONENTS**

IP 66



**COVER** made of shockproof resin material, UV-rays stabilized. Ring, eyelid and grid versions available.

*COVER in resina antiurto stabilizzata ai raggi UV, disponibile nella versione ad anello, a palpebra e a griglia.*

Opal **DIFFUSER** made of UV-rays stabilized polymethylmethacrylate (PMMA), with silicone rubber gasket to ensure high protection against external agents.

*DIFFUSORE opale realizzato in polimetilmetacrilato (PMMA) stabilizzato ai raggi UV. Completo di guarnizione in gomma siliconica per garantire un alto livello di protezione contro gli agenti esterni.*

**BASE** made of shockproof resin material, UV-rays stabilized, suitable for the electrical devices fixation. Provided with E27 or GX53 lampholder.

*BASE realizzata in resina antiurto, stabilizzata ai raggi UV, adatta ad alloggiare gli accessori elettrici. Fornita completa di portalamпада E27 o GX53.*

**DANZI**



**Dimensions and weight**

Width: 245 mm  
Height: 338 mm  
Depth: 90 mm  
Weight: 1 Kg

**Moulded colours:**

Black  White  Grey

**Diffuser PMMA:**

Opal

**GX53 LED**

FULLY PRE-WIRED



Bulkhead supplied **fully pre-wired** and complete with TÜV approved, long-life and efficient **GX53 LED** lamp in different wattages.

- **BUILT-IN DRIVER:** Quick and easy lamp replacement for a very simple maintenance after installation.
- **SUITABLE FOR OUTDOOR USE:** built-in driver fully protected against heat and humidity by silicone paste.

\*ADD. SUFFIX

	<b>11 W</b>	<b>1300 Lm</b>	4000 K	.B1L
			3000 K	.B1R
	<b>18 W</b>	<b>2000 Lm</b>	4000 K	.E1L
			3000 K	.E1R



**11W**  
**18W** = **100W**  
**150W**  
incandescent

**SAVE 90%**



**E27**

FULLY PRE-WIRED



Bulkhead supplied **fully pre-wired** with E27 lampholder and complete with highly heat resistant reflective plate made of white shockproof resin material, UV-rays stabilized.

\*ADD. SUFFIX

<b>E27</b> (CFL-LED)	max 180 mm	.E27
-------------------------	------------	------

**LED LAMPS**



More technical details about TÜV approved Fumagalli LED Lamps on page 468.

\* ADD THESE SUFFIXES TO THE REFERENCES MENTIONED IN THE CATALOGUE

**DANZI RANGE**  
OVAL

BULKHEAD

FLOODLIGHT

IN-GROUND

BRICKLIGHT

BOLLARDS

GARDEN

URBAN CLASSIC

URBAN MODERN

HIGH-BAY

POST

LAMPS

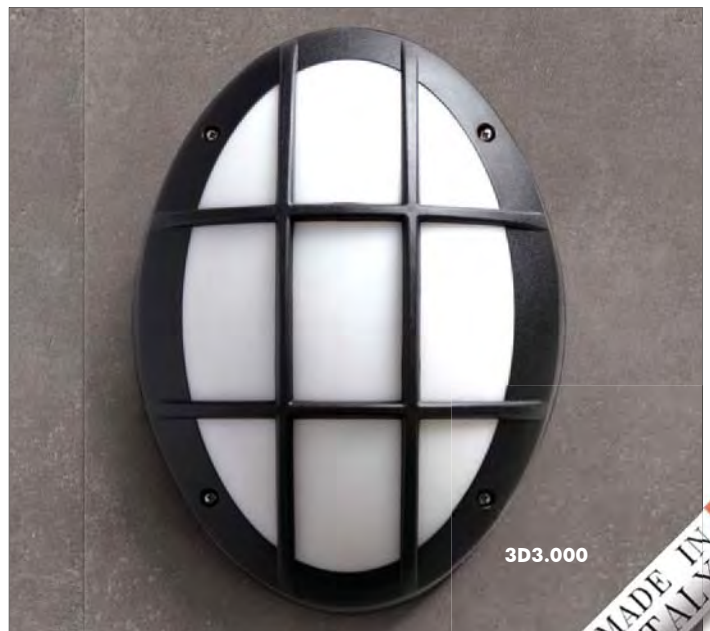

MADE IN ITALY

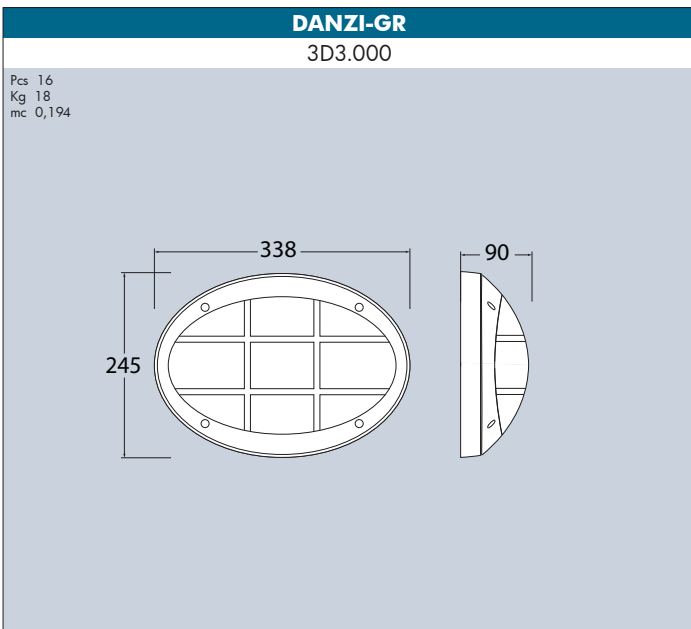
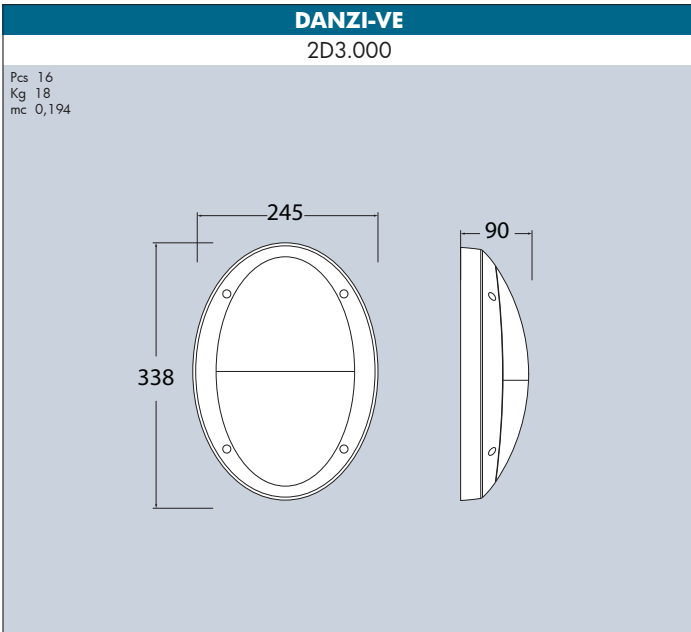
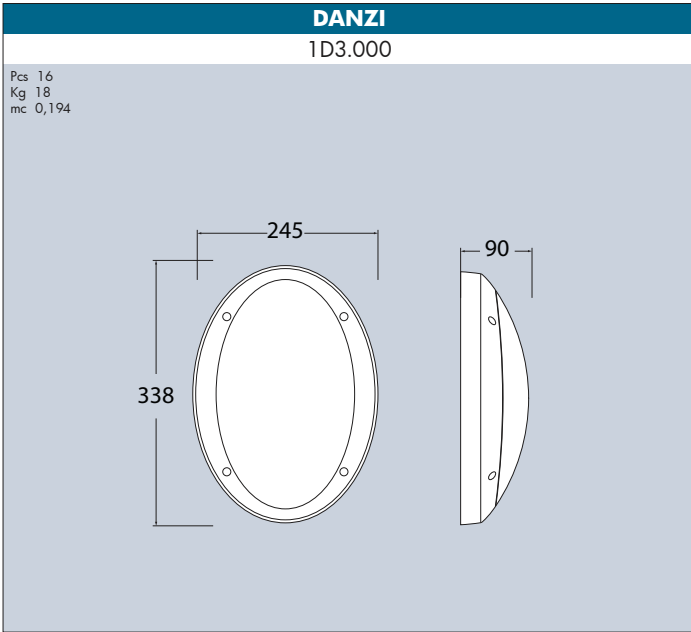



# STUCCHI SQUARE

BULKHEAD

FLOODLIGHT

IN-GROUND

BRICKLIGHT

BOLLARDS

GARDEN

URBAN CLASSIC

URBAN MODERN

HIGH-BAY

POST

LAMPS

Square bulkhead lamp made of shockproof resin material, UV-rays stabilized, rust and corrosion-free. Suitable for wall and ceiling installation. Supplied as option with colored backlit base. **GX53 LED** or **E27** version available. Insulation class II, Protection rating IP66.



STUCCHI  
1U3.000

*Plafoniera quadra realizzata in resina antiurto stabilizzata ai raggi UV, inattaccabile da ruggine e corrosione. Idonea per il montaggio a parete e a soffitto. Disponibile anche con base per retroilluminazione colorata. Fornita nella versione a **LED GX53** o **E27**. Classe di isolamento II, grado di protezione IP66.*



1U3.000.BU1

**STUCCHI - COMPONENTS**

IP 66



**COVER** made of shockproof resin material, UV-rays stabilized.

*COVER in resina antiurto stabilizzata ai raggi UV.*

Opal **DIFFUSER** made of UV-rays stabilized polymethylmethacrylate (PMMA), with silicone rubber gasket to ensure high protection against external agents.

*DIFFUSORE opale realizzato in polimetilmetacrilato (PMMA) stabilizzato ai raggi UV. Completo di guarnizione in gomma siliconica per garantire un alto livello di protezione contro gli agenti esterni.*

**BASE** made of shockproof resin material, provided with E27 or GX53 lampholder. Available in different backlit colours to create a coloured effect on wall and ceilings.

*BASE realizzata in resina antiurto, adatta ad alloggiare gli accessori elettrici. Fornita completa di portalampada E27 o GX53. Disponibile in diversi colori per creare una retroilluminazione colorata su pareti e soffitti.*



**STUCCHI**

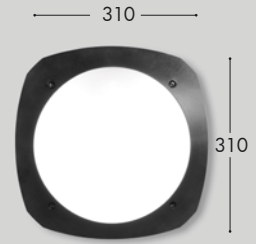

**Dimensions and weight**

Height: 310 mm  
Width: 310 mm  
Depth: 90 mm  
Weight: 1 Kg

**Moulded colours:**

Black  White  Grey

**Diffuser PMMA:**

Opal

**GX53 LED**

FULLY PRE-WIRED



Bulkhead supplied **fully pre-wired** and complete with TÜV approved, long-life and efficient **GX53 LED** lamp in different wattages.

- **BUILT-IN DRIVER:** Quick and easy lamp replacement for a very simple maintenance after installation.
- **SUITABLE FOR OUTDOOR USE:** built-in driver fully protected against heat and humidity by silicone paste.

\*ADD. SUFFIX

	11 W	1300 Lm	4000 K	.B1L
			3000 K	.B1R
	18 W	2000 Lm	4000 K	.E1L
			3000 K	.E1R

11W 18W = 100W 150W incandescent

**SAVE 90%**

**E27**

FULLY PRE-WIRED



Bulkhead supplied **fully pre-wired** with E27 lampholder and complete with highly heat resistant reflective plate made of white shockproof resin material, UV-rays stabilized.

\*ADD. SUFFIX

<b>E27</b> (CFL-LED)	max 180 mm	.E27
-------------------------	------------	------

**LED LAMPS**



More technical details about TÜV approved Fumagalli LED Lamps on page 468.

\*ADD THESE SUFFIXES TO THE REFERENCES MENTIONED IN THE CATALOGUE

**STUCCHI**  
**SQUARE**

BULKHEAD

FLOODLIGHT

IN-GROUND

BRICKLIGHT

BOLLARDS

GARDEN

URBAN CLASSIC

URBAN MODERN

HIGH-BAY

POST

LAMPS



MADE IN ITALY

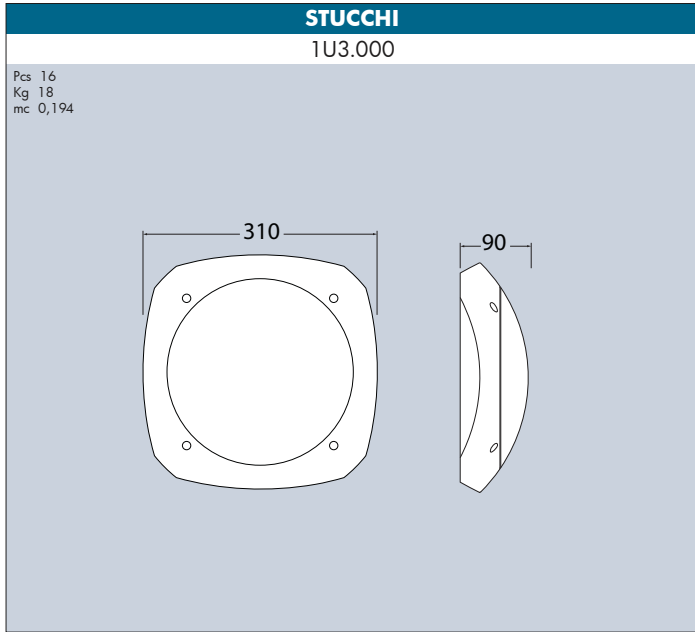
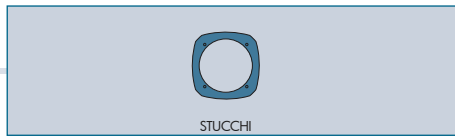

BULKHEAD

FLOODLIGHT

IN-GROUND

BRICKLIGHT

BOLLARDS

GARDEN

URBAN CLASSIC

URBAN MODERN

HIGH-BAY

POST

LAMPS

# CECCHI RECTANGULAR

BULKHEAD

FLOODLIGHT

IN-GROUND

BRICKLIGHT

BOLLARDS

GARDEN

URBAN CLASSIC

URBAN MODERN

HIGH-BAY

POST

LAMPS

Rectangular bulkhead lamp made of shockproof resin material, UV-rays stabilized, rust and corrosion-free. Suitable for wall and ceiling installation. Supplied as option with coloured backlit base. **GX53 LED** or **E27** version available. Insulation class II, Protection rating IP66.



*Plafoniera rettangolare realizzata in resina antiurto stabilizzata ai raggi UV, inattaccabile da ruggine e corrosione. Idonea per il montaggio a parete e a soffitto. Disponibile anche con base per retroilluminazione colorata. Fornita nella versione a **LED GX53** o **E27**. Classe di isolamento II, grado di protezione IP66.*

1H3.000.CL1



UV-TREATED	DOUBLE INSULATION		PUBLIC	RESIDENTIAL	INDOOR & OUTDOOR
RECYCLABLE	ANTI-SHOCK	TEMPERATURE	WALL	CEILING	



**CECCHI COMPONENTS**

**IP 66**



**COVER** made of shockproof resin material, UV-rays stabilized.  
*COVER in resina antiurto stabilizzata ai raggi UV.*

**Opal DIFFUSER** made of UV-rays stabilized polymethylmethacrylate (PMMA), with silicone rubber gasket to ensure high protection against external agents.  
*DIFFUSORE opale realizzato in polimetilmetacrilato (PMMA) stabilizzato ai raggi UV. Completo di guarnizione in gomma siliconica per garantire un alto livello di protezione contro gli agenti esterni.*

**BASE** made of shockproof resin material, provided with E27 or GX53 lampholder. Available in different backlit colours to create a coloured effect on wall and ceilings.  
*BASE realizzata in resina antiurto, adatta ad alloggiare gli accessori elettrici. Fornita completa di portalampada E27 o GX53. Disponibile in diversi colori per creare una retroilluminazione colorata su pareti e soffitti.*

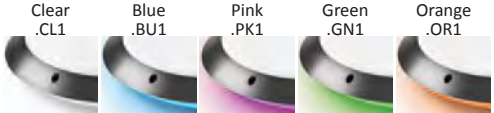

**Dimensions and weight**  
Width: 338 mm  
Height: 245 mm  
Depth: 90 mm  
Weight: 1 Kg

**Moulded colours:**  
Black White Grey  
**Diffuser PMMA:**  
Opal

**GX53 LED**



Bulkhead supplied **fully pre-wired** and complete with TÜV approved, long-life and efficient **GX53 LED** lamp in different wattages.

- **BUILT-IN DRIVER:** Quick and easy lamp replacement for a very simple maintenance after installation.
- **SUITABLE FOR OUTDOOR USE:** built-in driver fully protected against heat and humidity by silicone paste.

	<b>11 W</b>	<b>1300 Lm</b>	4000 K	.B1L
			3000 K	.B1R
	<b>18 W</b>	<b>2000 Lm</b>	4000 K	.E1L
			3000 K	.E1R

**11W 18W = 100W 150W**  
incandescent  
**SAVE 90%**

**E27**



Bulkhead supplied **fully pre-wired** with E27 lampholder and complete with highly heat resistant reflective plate made of white shockproof resin material, UV-rays stabilized.

<b>E27</b> (CFL-LED)	max 180 mm	*ADD. SUFFIX .E27
-------------------------	------------	----------------------

**LED LAMPS**

More technical details about TÜV approved Fumagalli LED Lamps on page 468.



\* ADD THESE SUFFIXES TO THE REFERENCES MENTIONED IN THE CATALOGUE

BULKHEAD

FLOODLIGHT

IN-GROUND

BRICKLIGHT

BOLLARDS

GARDEN

URBAN CLASSIC

URBAN MODERN

HIGH-BAY

POST

LAMPS



MADE IN ITALY

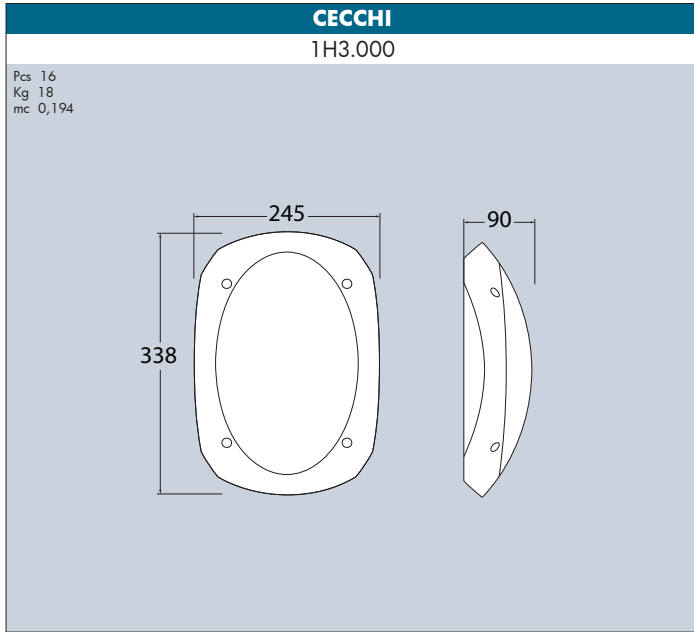



# RITA

## CLASSIC ROUND

BULKHEAD

FLOODLIGHT

IN-GROUND

BRICKLIGHT

BOLLARDS

GARDEN

URBAN CLASSIC

URBAN MODERN

HIGH-BAY

POST

LAMPS

Round bulkhead lamp in classic style, made of shockproof resin material, UV-rays stabilized, rust and corrosion-free. Suitable for wall and ceiling installation. **GX53 LED** or **E27** version available. Insulation class II, Protection rating IP66.



RITA  
113.000

*Plafoniera circolare in stile classico, realizzata in resina antiurto stabilizzata ai raggi UV, inattaccabile da ruggine e corrosione. Idonea per il montaggio a parete e a soffitto. Disponibile nella versione a **LED GX53** o **E27**. Classe di isolamento II, grado di protezione IP66.*



113.000

RECYCLABLE	ANTI-SHOCK	TEMPERATURE	WALL	CEILING	



**RITA COMPONENTS**

IP 66



**COVER** with classic design made of shockproof resin material, UV-rays stabilized.

*COVER in stile classico realizzata in resina antiurto stabilizzata ai raggi UV.*

Opal **DIFFUSER** made of UV-rays stabilized polymethylmethacrylate (PMMA), with silicone rubber gasket to ensure high protection against external agents.

*DIFFUSORE opale realizzato in polimetilmetacrilato (PMMA) stabilizzato ai raggi UV. Completo di guarnizione in gomma silconica per garantire un alto livello di protezione contro gli agenti esterni.*

**BASE** made of shockproof resin material, UV rays stabilized, suitable for the electrical devices fixation. Provided with E27 or GX53 lampholder.

*BASE realizzata in resina antiurto, stabilizzata ai raggi UV, adatta ad alloggiare gli accessori elettrici. Fornita completa di portalamпада E27 o GX53.*

**RITA**

— ø 355 —



**Dimensions and weight**

Diameter: ø 355 mm  
Depth: 90 mm  
Weight: 1 Kg

**Moulded colours:**

Black  White

**Painted colours:**

Antique green  Antique bronze

**Diffuser PMMA:**

Opal

**GX53 LED**

FULLY PRE-WIRED



Bulkhead supplied **fully pre-wired** and complete with TÜV approved, long-life and efficient **GX53 LED** lamp in different wattages.

- **BUILT-IN DRIVER:** Quick and easy lamp replacement for a very simple maintenance after installation.
- **SUITABLE FOR OUTDOOR USE:** built-in driver fully protected against heat and humidity by silicone paste.

\*ADD. SUFFIX

	11 W	1300 Lm	4000 K	.B1L
			3000 K	.B1R
	18 W	2000 Lm	4000 K	.E1L
			3000 K	.E1R

11W 18W = 100W 150W incandescent

**SAVE 90%**

**E27**

FULLY PRE-WIRED



Bulkhead supplied **fully pre-wired** with E27 lampholder and complete with highly heat resistant reflective plate made of white shockproof resin material, UV-rays stabilized.

\*ADD. SUFFIX

<b>E27</b> (CFL-LED)	max 180 mm	.E27
-------------------------	------------	------

**LED LAMPS**



More technical details about TÜV approved Fumagalli LED Lamps on page 468.

\* ADD THESE SUFFIXES TO THE REFERENCES MENTIONED IN THE CATALOGUE

**RITA**  
CLASSIC ROUND

BULKHEAD

FLOODLIGHT

IN-GROUND

BRICKLIGHT

BOLLARDS

GARDEN

URBAN CLASSIC

URBAN MODERN

HIGH-BAY

POST

LAMPS



1T3.000

MADE IN ITALY

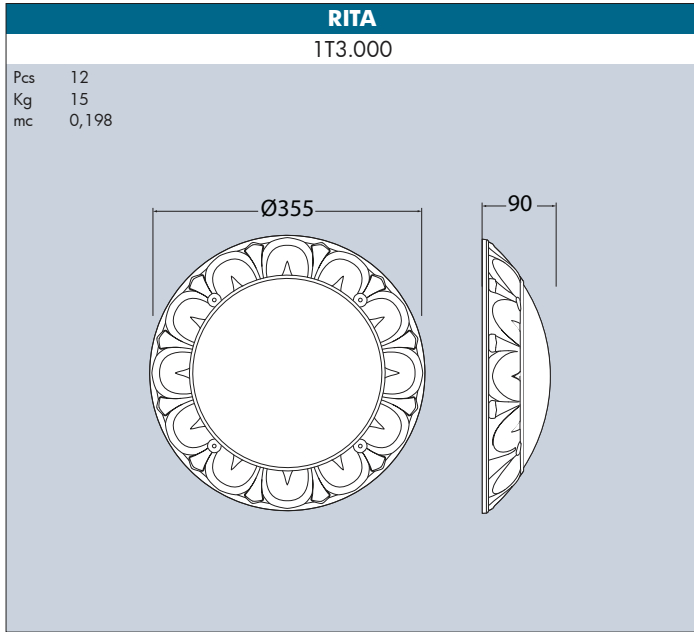

BULKHEAD

FLOODLIGHT

IN-GROUND

BRICKLIGHT

BOLLARDS

GARDEN

URBAN CLASSIC

URBAN MODERN

HIGH-BAY

POST

LAMPS

# LUCIA RANGE

## ROUND

BULKHEAD  
FLOODLIGHT  
IN-GROUND  
BRICKLIGHT  
BOLLARDS  
GARDEN  
URBAN CLASSIC  
URBAN MODERN  
HIGH-BAY  
POST  
LAMPS

Round bulkhead lamp with ring, eyelid or guard cover. Made of shockproof resin material, UV-rays stabilized, rust and corrosion-free. Suitable for ceiling, wall and post installation also with bracket angled at 35°. Supplied as option with coloured backlit base. **GX53 LED** or **E27** version available. Insulation class II, Protection rating IP66.

*Plafoniera circolare con cover ad anello, a palpebra o a manubrio. Realizzata in resina antiurto stabilizzata ai raggi UV, inattaccabile da ruggine e corrosione. Idonea per il montaggio a parete, a soffitto e a palo anche con braccio angolato a 35°. Disponibile anche con base per retroilluminazione colorata. Fornita nella versione a **LED GX53** o **E27**. Classe di isolamento II, grado di protezione IP66.*

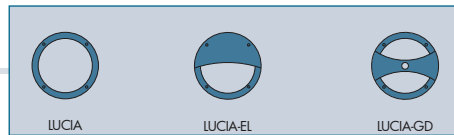

1R3.000.0R1

**LUCIA COMPONENTS**

**IP 66**



**COVER** made of shockproof resin material, UV-rays stabilized. Ring, eyelid and grid versions available.

***COVER** in resina antiurto stabilizzata ai raggi UV, disponibile nella versione ad anello, a palpebra e a griglia.*

Opal **DIFFUSER** made of UV-rays stabilized polymethylmethacrylate (PMMA), with silicone rubber gasket to ensure high protection against external agents.

***DIFFUSORE** opale realizzato in polimetilmetacrilato (PMMA) stabilizzato ai raggi UV. Completo di guarnizione in gomma siliconica per garantire un alto livello di protezione contro gli agenti esterni.*

**BASE** made of shockproof resin material, provided with E27 or GX53 lampholder. Available in different backlit colours to create a coloured effect on wall and ceilings.

***BASE** realizzata in resina antiurto, adatta ad alloggiare gli accessori elettrici. Fornita completa di portalamпада E27 o GX53. Disponibile in diversi colori per creare una retroilluminazione colorata su pareti e soffitti.*



**LUCIA**

—  $\varnothing$  300 —



**Dimensions and weight**

Diameter:  $\varnothing$  300 mm  
Depth: 90 mm  
Weight: 1 Kg

**Moulded colours:**

Black  White  Grey

**Diffuser PMMA:**

Opal

**GX53 LED**

FULLY PRE-WIRED



Bulkhead supplied **fully pre-wired** and complete with TÜV approved, long-life and efficient **GX53 LED** lamp in different wattages.

- **BUILT-IN DRIVER:** Quick and easy lamp replacement for a very simple maintenance after installation.
- **SUITABLE FOR OUTDOOR USE:** built-in driver fully protected against heat and humidity by silicone paste.

\*ADD. SUFFIX

	<b>11 W</b>	<b>1300 Lm</b>	4000 K	.B1L
			3000 K	.B1R
	<b>18 W</b>	<b>2000 Lm</b>	4000 K	.E1L
			3000 K	.E1R



**11W**  
**18W** = **100W**  
**150W** incandescent

**SAVE 90%**

**E27**

FULLY PRE-WIRED



Bulkhead supplied **fully pre-wired** with E27 lampholder and complete with highly heat resistant reflective plate made of white shockproof resin material, UV-rays stabilized.

\*ADD. SUFFIX

<b>E27</b> (CFL-LED)	max 180 mm	.E27
-------------------------	------------	------

**POST VERSION**



Lucia bulkhead range can be mounted on a pole with or without an angled bracket.

\* ADD THESE SUFFIXES TO THE REFERENCES MENTIONED IN THE CATALOGUE

**LED LAMPS**



More technical details about TÜV approved Fumagalli LED Lamps on page 468.

**LUCIA RANGE**  
**ROUND**

BULKHEAD

FLOODLIGHT

IN-GROUND

BRICKLIGHT

BOLLARDS

GARDEN

URBAN CLASSIC

URBAN MODERN

HIGH-BAY

POST

LAMPS



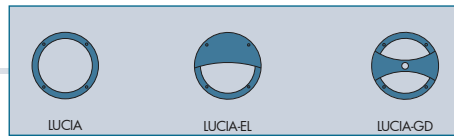

**LUCIA**  
1R3.000

Pcs 16  
Kg 18  
mc 0,194

**GABRI/  
LUCIA 1L**  
1R3.613.010

Pcs 1  
Kg 4  
mc 0,097

**GABRI/  
LUCIA 2L**  
1R3.613.020

Pcs 1  
Kg 5  
mc 0,097

**MINIGABRI/  
LUCIA 1L**  
1R3.612.010

Pcs 1  
Kg 3,5  
mc 0,065

**MINIGABRI/  
LUCIA 2L**  
1R3.612.020

Pcs 1  
Kg 4,5  
mc 0,065

**LUCIA-EL**  
2R3.000

Pcs 16  
Kg 18  
mc 0,194

**GABRI/  
LUCIA-EL 1L**  
2R3.613.010

Pcs 1  
Kg 4  
mc 0,097

**GABRI/  
LUCIA-EL 2L**  
2R3.613.020

Pcs 1  
Kg 5  
mc 0,097

**MINIGABRI/  
LUCIA-EL 1L**  
2R3.612.010

Pcs 1  
Kg 3,5  
mc 0,065

**MINIGABRI/  
LUCIA-EL 2L**  
2R3.612.020

Pcs 1  
Kg 4,5  
mc 0,065

**LUCIA-GD**  
3R3.000

Pcs 16  
Kg 18  
mc 0,194

**GABRI/  
LUCIA-GD 1L**  
3R3.613.010

Pcs 1  
Kg 4  
mc 0,097

**GABRI/  
LUCIA-GD 2L**  
3R3.613.020

Pcs 1  
Kg 5  
mc 0,097

**MINIGABRI/  
LUCIA-GD 1L**  
3R3.612.010

Pcs 1  
Kg 3,5  
mc 0,065

**MINIGABRI/  
LUCIA-GD 2L**  
3R3.612.020

Pcs 1  
Kg 4,5  
mc 0,065

BULKHEAD

FLOODLIGHT

IN-GROUND

BRICKLIGHT

BOLLARDS

GARDEN

URBAN CLASSIC

URBAN MODERN

HIGH-BAY

POST

LAMPS



**REMI/LUCIA RANGE**  
**ROUND**

BULKHEAD

FLOODLIGHT

IN-GROUND

BRICKLIGHT

BOLLARDS

GARDEN

URBAN CLASSIC

URBAN MODERN

HIGH-BAY

POST

LAMPS



MADE IN ITALY

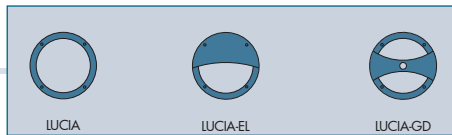

**REMI/LUCIA**  
1R3.602

Pcs 16  
Kg 18  
mc 0,194

**GABRI REMI/LUCIA 1L**  
1R3.613.X10

Pcs 1  
Kg 4,5  
mc 0,097

**GABRI REMI/LUCIA 2L**  
1R3.613.X20

Pcs 1  
Kg 6  
mc 0,097

**MINIGABRI REMI/LUCIA 1L**  
1R3.612.X10

Pcs 1  
Kg 3,5  
mc 0,065

**MINIGABRI REMI/LUCIA 2L**  
1R3.612.X20

Pcs 1  
Kg 5  
mc 0,065

**REMI/LUCIA-EL**  
2R3.602

Pcs 16  
Kg 18  
mc 0,194

**GABRI REMI/LUCIA-EL 1L**  
2R3.613.X10

Pcs 1  
Kg 4,5  
mc 0,097

**GABRI REMI/LUCIA-EL 2L**  
2R3.613.X20

Pcs 1  
Kg 6  
mc 0,097

**MINIGABRI REMI/LUCIA-EL 1L**  
2R3.612.X10

Pcs 1  
Kg 3,5  
mc 0,065

**MINIGABRI REMI/LUCIA-EL 2L**  
2R3.612.X20

Pcs 1  
Kg 5  
mc 0,065

**REMI/LUCIA-GD**  
3R3.602

Pcs 16  
Kg 18  
mc 0,194

**GABRI REMI/LUCIA-GD 1L**  
3R3.613.X10

Pcs 1  
Kg 4,5  
mc 0,097

**GABRI REMI/LUCIA-GD 2L**  
3R3.613.X20

Pcs 1  
Kg 6  
mc 0,097

**MINIGABRI REMI/LUCIA-GD 1L**  
3R3.612.X10

Pcs 1  
Kg 3,5  
mc 0,065

**MINIGABRI REMI/LUCIA-GD 2L**  
3R3.612.X20

Pcs 1  
Kg 5  
mc 0,065

BULKHEAD

FLOODLIGHT

IN-GROUND

BRICKLIGHT

BOLLARDS

GARDEN

URBAN CLASSIC

URBAN MODERN

HIGH-BAY

POST

LAMPS

# MADDI RANGE

## OVAL

BULKHEAD  
FLOODLIGHT  
IN-GROUND  
BRICKLIGHT  
BOLLARDS  
GARDEN  
URBAN CLASSIC  
URBAN MODERN  
HIGH-BAY  
POST  
LAMPS

Oval bulkhead lamp with ring, vertical eyelid or horizontal eyelid cover. Made of shockproof resin material, UV-rays stabilized, rust and corrosion-free. Suitable for wall, ceiling and post installation also with bracket angled at 35°. Supplied as option with coloured backlit base. **GX53 LED** or **E27** version available. Insulation class II, Protection rating IP66.

*Plafoniera ovale con cover ad anello o a palpebra (orizzontale o verticale). Realizzata in resina antiurto stabilizzata ai raggi UV, inattaccabile da ruggine e corrosione. Idonea per il montaggio a parete, a soffitto e a palo anche con braccio angolato a 35°. Disponibile anche con base per retroilluminazione colorata. Fornita nella versione a **LED GX53** o **E27**. Classe di isolamento II, grado di protezione IP66.*



1V3.000

MADE IN ITALY

**MADDI COMPONENTS**

IP 66



**COVER** made of shockproof resin material, UV-rays stabilized. Ring, eyelid and grid versions available.

*COVER in resina antiurto stabilizzata ai raggi UV, disponibile nella versione ad anello, a palpebra e a griglia.*

Opal **DIFFUSER** made of UV-rays stabilized polymethylmethacrylate (PMMA), with silicone rubber gasket to ensure high protection against external agents.

*DIFFUSORE opale realizzato in polimetilmetacrilato (PMMA) stabilizzato ai raggi UV. Completo di guarnizione in gomma silicica per garantire un alto livello di protezione contro gli agenti esterni.*

**BASE** made of shockproof resin material, provided with E27 or GX53 lampholder. Available in different backlit colours to create a coloured effect on wall and ceilings.

*BASE realizzata in resina antiurto, adatta ad alloggiare gli accessori elettrici. Fornita completa di portalampada E27 o GX53. Disponibile in diversi colori per creare una retroilluminazione colorata su pareti e soffitti.*

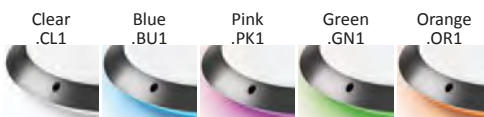

**MADDI**



**Dimensions and weight**

Width: 230 mm  
Height: 330 mm  
Depth: 90 mm  
Weight: 1 Kg

**Moulded colours:**

Black    White    Grey

**Diffuser PMMA:**

Opal

**GX53 LED**

FULLY PRE-WIRED



Bulkhead supplied **fully pre-wired** and complete with TÜV approved, long-life and efficient **GX53 LED** lamp in different wattages.

- **BUILT-IN DRIVER:** Quick and easy lamp replacement for a very simple maintenance after installation.
- **SUITABLE FOR OUTDOOR USE:** built-in driver fully protected against heat and humidity by silicone paste.

\*ADD. SUFFIX

	<b>11 W</b>	<b>1300 Lm</b>	4000 K	.B1L
			3000 K	.B1R
	<b>18 W</b>	<b>2000 Lm</b>	4000 K	.E1L
			3000 K	.E1R



**11W**  
**18W** = **100W**  
**150W**  
incandescent

**SAVE 90%**

**E27**

FULLY PRE-WIRED



Bulkhead supplied **fully pre-wired** with E27 lampholder and complete with highly heat resistant reflective plate made of white shockproof resin material, UV-rays stabilized.

\*ADD. SUFFIX

<b>E27</b> (CFL-LED)	max 180 mm	.E27
-------------------------	------------	------

**POST VERSION**



Maddi bulkhead range can be mounted on a pole with or without an angled bracket.

\*ADD THESE SUFFIXES TO THE REFERENCES MENTIONED IN THE CATALOGUE

**LED LAMPS**



More technical details about TÜV approved Fumagalli LED Lamps on page 468.

**MADDI RANGE**  
OVAL

BULKHEAD

FLOODLIGHT

IN-GROUND

BRICKLIGHT

BOLLARDS

GARDEN

URBAN CLASSIC

URBAN MODERN

HIGH-BAY

POST

LAMPS



MADE IN ITALY

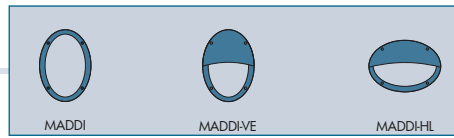

**MADDI**  
1V3.000

Pcs 16  
Kg 18  
mc 0,194

**GABRI/  
MADDI 1L**  
1V3.613.010

Pcs 1  
Kg 4  
mc 0,097

**GABRI/  
MADDI 2L**  
1V3.613.020

Pcs 1  
Kg 5  
mc 0,097

**MINIGABRI/  
MADDI 1L**  
1V3.612.010

Pcs 1  
Kg 3,5  
mc 0,065

**MINIGABRI/  
MADDI 2L**  
1V3.612.020

Pcs 1  
Kg 4,5  
mc 0,065

**MADDI-VE**  
2V3.000

Pcs 16  
Kg 18  
mc 0,194

**GABRI/  
MADDI-VE 1L**  
2V3.613.010

Pcs 1  
Kg 4  
mc 0,097

**GABRI/  
MADDI-VE 2L**  
2V3.613.020

Pcs 1  
Kg 5  
mc 0,097

**MINIGABRI/  
MADDI-VE 1L**  
2V3.612.010

Pcs 1  
Kg 3,5  
mc 0,065

**MINIGABRI/  
MADDI-VE 2L**  
2V3.612.020

Pcs 1  
Kg 4,5  
mc 0,065

**MADDI-HL**  
3V3.000

Pcs 16  
Kg 18  
mc 0,194

BULKHEAD

FLOODLIGHT

IN-GROUND

BRICKLIGHT

BOLLARDS

GARDEN

URBAN CLASSIC

URBAN MODERN

HIGH-BAY

POST

LAMPS

**REMI/MADDI RANGE**  
OVAL

BULKHEAD

FLOODLIGHT

IN-GROUND

BRICKLIGHT

BOLLARDS

GARDEN

URBAN CLASSIC

URBAN MODERN

HIGH-BAY

POST

LAMPS



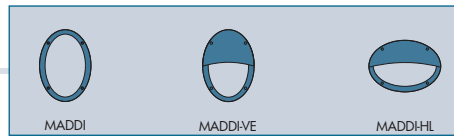

**REMI/MADDI**  
1V3.602

Pcs 16  
Kg 18  
mc 0,194

**GABRI REMI/MADDI 1L**  
1V3.613.X10

Pcs 1  
Kg 4,5  
mc 0,097

**GABRI REMI/MADDI 2L**  
1V3.613.X20

Pcs 1  
Kg 6  
mc 0,097

**MINIGABRI REMI/MADDI 1L**  
1V3.612.X10

Pcs 1  
Kg 3,5  
mc 0,065

**MINIGABRI REMI/MADDI 2L**  
1V3.612.X20

Pcs 1  
Kg 5  
mc 0,065

**REMI/MADDI-VE**  
2V3.602

Pcs 16  
Kg 18  
mc 0,194

**GABRI REMI/MADDI-VE 1L**  
2V3.613.X10

Pcs 1  
Kg 4,5  
mc 0,097

**GABRI REMI/MADDI-VE 2L**  
2V3.613.X20

Pcs 1  
Kg 6  
mc 0,097

**MINIGABRI REMI/MADDI-VE 1L**  
2V3.612.X10

Pcs 1  
Kg 3,5  
mc 0,065

**MINIGABRI REMI/MADDI-VE 2L**  
2V3.612.X20

Pcs 1  
Kg 5  
mc 0,065

**REMI/MADDI-HL**  
3V3.602

Pcs 16  
Kg 18  
mc 0,194

**GABRI REMI/MADDI-HL 1L**  
3V3.613.X10

Pcs 1  
Kg 4,5  
mc 0,097

**GABRI REMI/MADDI-HL 2L**  
3V3.613.X20

Pcs 1  
Kg 6  
mc 0,097

**MINIGABRI REMI/MADDI-HL 1L**  
3V3.612.X10

Pcs 1  
Kg 3,5  
mc 0,065

**MINIGABRI REMI/MADDI-HL 2L**  
3V3.612.X20

Pcs 1  
Kg 5  
mc 0,065

BULKHEAD  
FLOODLIGHT  
IN-GROUND  
BRICKLIGHT  
BOLLARDS  
GARDEN  
URBAN CLASSIC  
URBAN MODERN  
HIGH-BAY  
POST  
LAMPS



	LAMPS
	POST
	HIGH-BAY
	URBAN MODERN
	URBAN CLASSIC
	GARDEN
	BOLLARDS
	BRICKLIGHT
	IN-GROUND
	FLOODLIGHT
	BULKHEAD

# FLOODLIGHT

MINITOMMY  
FLOODLIGHT&SPIKE



82

MINITOMMY-EL  
FLOODLIGHT&SPIKE



86

TOMMY  
FLOODLIGHT&SPIKE



88

TOMMY-EL  
FLOODLIGHT&SPIKE



92

TOMMY-SQ  
FLOODLIGHT&SPIKE



94

GIOVA/GERMANA  
FLOODLIGHT



96

GERMANA  
WALL FLOODLIGHT



100

PINELA  
SMALL POLE



102

GIOVA/GIUSEPPE  
FLOODLIGHT



104

GIUSEPPE  
WALL FLOODLIGHT



108

PINA  
SMALL POLE



110

# MINITOMMY FLOODLIGHT

BULKHEAD  
FLOODLIGHT  
IN-GROUND  
BRICKLIGHT  
BOLLARDS  
GARDEN  
URBAN CLASSIC  
URBAN MODERN  
HIGH-BAY  
POST  
LAMPS

LED floodlight with single or double lights made of shockproof resin material, UV-rays stabilized, rust and corrosion-free. Suitable for indoor and outdoor installations on wall and ceilings, in the ground or on spikes. Ring or eyelid cover versions available with no visible screws. Supplied as standard with TÜV approved, long-life and efficient **GU10 LED lamp included**. The floodlight is fully adjustable and it can tilt and turn at will. Insulation class II, Protection rating IP66.



*Proiettore a LED a luce singola o doppia fabbricato in resina antiurto stabilizzata ai raggi UV inattaccabile da ruggine e corrosione. Idoneo per installazioni a parete, a soffitto, al suolo o su picchetto, sia in ambienti esterni che interni. Cover ad anello o a palpebra senza viti a vista. Fornito nella versione standard con **inclusa lampadina a LED GU10** approvata TÜV di lunga durata ed elevata efficienza. Il proiettore è completamente regolabile e si può inclinare e orientare a piacimento. Classe di isolamento II, grado di protezione IP66.*



1M1.001.U1.L

MADE IN ITALY

**MINITOMMY - COMPONENTS**

IP 66



**COVER** with no visible screws made of shockproof resin material, UV-rays stabilized, rust and corrosion free. Ring or eyelid versions available.

**COVER** senza viti a vista in resina antiurto stabilizzata ai raggi UV inattaccabile da ruggine e corrosione. Disponibile nella versione ad anello o a palpebra.

**DIFFUSER** made of shockproof resin material (PC) complete with silicone rubber gasket to ensure high protection against external agents. Frosted or coloured versions, to get a customized ambiance.

**DIFFUSORE** in resina antiurto (PC) completo di guarnizione in gomma siliconica per garantire un alto livello di protezione contro gli agenti esterni. Disponibile nella versione satinata o colorata, per ottenere un'ambientazione personalizzata.



Resin **BODY** suitable for the electrical devices fixation and resin **SUPPORT FORK** to allow a fully adjustable floodlight position.

**CORPO** in resina predisposto per il fissaggio degli accessori elettrici e **FORCELLA** di supporto per permettere l'orientamento del proiettore.

**INSTALLATION ELEMENTS:**

- ROTATION DISK for surface installation.
- SPIKE for in ground installation.
- CONNECTION FITTING for double lights version.

**ELEMENTI DI FISSAGGIO:**

- DISCO DI ROTAZIONE per l'installazione a parete.
- PICCHETTO per l'installazione nel terreno.
- SUPPORTO per la versione a luce doppia.

**MINITOMMY**



127

**Dimensions and weight**

Height: 127 mm  
Width: 122 mm  
Weight: 0,45 Kg

**Moulded Colours:**

Black Grey White

**Diffuser PC:**

Frosted  
Blue Green Orange

**GU10 LED**

\*ADD. SUFFIX



	<b>4,5W</b>	<b>300 Lm</b>	4000 K	.U1L
			3000 K	.U1R

Floodlight supplied as standard with TÜV approved, long-life and efficient **GU10 LED lamp** included. Quick and easy lamp replacement for a very simple maintenance after installation.

- **COST SAVING:** long-life and efficient LED light sources
- **BUILT-IN DRIVER:** quick and easy lamp replacement
- **GREAT FLEXIBILITY:** GU10 standard lamp holder
- **FUTURE-PROOFED LUMINARIES:** performances easy to upgrade to latest technology developments
- **SUITABLE FOR OUTDOOR USE:** built-in driver fully protected against heat and humidity by silicone paste.

**LED LAMPS**



More technical details about TÜV approved Fumagalli LED Lamps on page 468.

\* ADD THESE SUFFIXES TO THE REFERENCES MENTIONED IN THE CATALOGUE

BULKHEAD

FLOODLIGHT

IN-GROUND

BRICKLIGHT

BOLLARDS

GARDEN

URBAN CLASSIC

URBAN MODERN

HIGH-BAY

POST

LAMPS



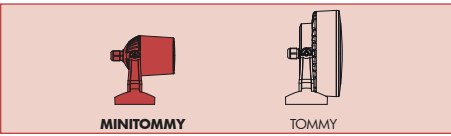

**MINITOMMY**

1M1.000.U1L	<b>4,5W</b>	1M1.000.U1R
4000K	GU10 LED LAMP INCLUDED	3000K

Pcs 30  
Kg 19  
mc 0,092

**MINITOMMY SPIKE**

1M1.001.U1L	<b>4,5W</b>	1M1.001.U1R
4000K	GU10 LED LAMP INCLUDED	3000K

Pcs 30  
Kg 20  
mc 0,092

**MINITOMMY 2L**

3M1.000.U2L	<b>9W</b>	3M1.000.U2R
4000K	2 GU10 LED LAMPS INCLUDED	3000K

Pcs 18  
Kg 24  
mc 0,092

**MINITOMMY 2L SPIKE**

3M1.001.U2L	<b>9W</b>	3M1.001.U2R
4000K	2 GU10 LED LAMPS INCLUDED	3000K

Pcs 18  
Kg 25  
mc 0,092

**MINITOMMY-EL**  
FLOODLIGHT

BULKHEAD

FLOODLIGHT

IN-GROUND

BRICKLIGHT

BOLLARDS

GARDEN

URBAN CLASSIC

URBAN MODERN

HIGH-BAY

POST

LAMPS



MADE IN  
ITALY

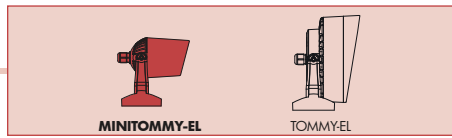

MINITOMMY-EL		
1M2.000.U1L	<b>4,5W</b>	1M2.000.U1R
4000K	GU10 LED LAMP INCLUDED	3000K
Pcs 30 Kg 19 mc 0,092		

MINITOMMY-EL SPIKE		
1M2.001.U1L	<b>4,5W</b>	1M2.001.U1R
4000K	GU10 LED LAMP INCLUDED	3000K
Pcs 30 Kg 20 mc 0,092		

MINITOMMY-EL 2L		
3M2.000.U2L	<b>9W</b>	3M2.000.U2R
4000K	2 GU10 LED LAMPS INCLUDED	3000K
Pcs 18 Kg 24 mc 0,092		

MINITOMMY-EL 2L SPIKE		
3M2.001.U2L	<b>9W</b>	3M2.001.U2R
4000K	2 GU10 LED LAMPS INCLUDED	3000K
Pcs 18 Kg 25 mc 0,092		

BULKHEAD

FLOODLIGHT

IN-GROUND

BRICKLIGHT

BOLLARDS

GARDEN

URBAN CLASSIC

URBAN MODERN

HIGH-BAY

POST

LAMPS



# TOMMY FLOODLIGHT



LED floodlight with single or double lights made of shockproof resin material, UV-rays stabilized, rust and corrosion-free. Suitable for indoor and outdoor installations on wall and ceilings, in the ground or on spikes. Square, ring or eyelid cover versions available with no visible screws. Supplied as standard with TÜV approved, long-life and efficient **GX53 LED lamp included**. The floodlight is fully adjustable and it can tilt and turn at will. Insulation class II, Protection rating IP66.

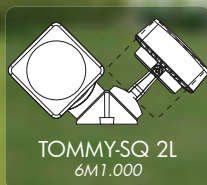
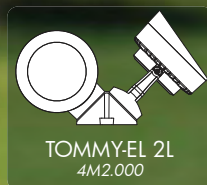

*Proiettore a LED a luce singola o doppia fabbricato in resina antiurto stabilizzata ai raggi UV, inattaccabile da ruggine e corrosione. Idoneo per installazioni a parete, a soffitto, al suolo o su picchetto, sia in ambienti esterni che interni. Cover quadrata, ad anello o a palpebra senza viti a vista. Fornito con **inclusa lampadina a LED GX53** approvata TÜV di lunga durata ed elevata efficienza. Il proiettore è completamente regolabile e si può inclinare e orientare a piacimento. Classe di isolamento II, grado di protezione IP66.*

2M1.001.D1L

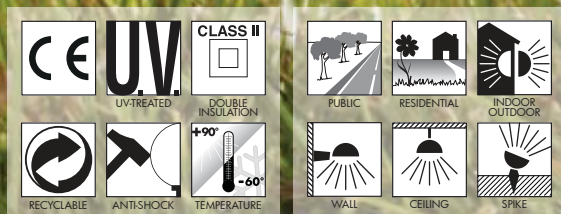

MADE IN ITALY



MINITOMMY

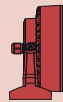

TOMMY

**TOMMY - COMPONENTS**

IP 66



**COVER** with no visible screws made of shockproof resin material, UV-rays stabilized, rust and corrosion free. Ring or eyelid versions available.

**COVER** senza viti a vista in resina antiurto stabilizzata ai raggi UV inattaccabile da ruggine e corrosione. Disponibile nella versione ad anello o a palpebra.

**DIFFUSER** made of shockproof resin material (PC) complete with silicone rubber gasket to ensure high protection against external agents. Frosted or coloured versions, to get a customized ambiance.

**DIFFUSORE** in resina antiurto (PC) completo di guarnizione in gomma siliconica per garantire un alto livello di protezione contro gli agenti esterni. Disponibile nella versione satinata o colorata, per ottenere un'ambientazione personalizzata.

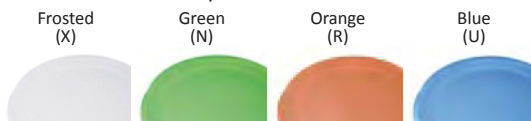

Resin **BODY** suitable for the electrical devices fixation and resin **SUPPORT FORK** to allow a fully adjustable floodlight position.

**CORPO** in resina predisposto per il fissaggio degli accessori elettrici e **FORCELLA** di supporto per permettere l'orientamento del proiettore.

**INSTALLATION ELEMENTS:**

- ROTATION DISK for surface installation.
- SPIKE for in ground installation.
- CONNECTION FITTING for double lights version.

**ELEMENTI DI FISSAGGIO:**

- DISCO DI ROTAZIONE per l'installazione a parete.
- PICCHETTO per l'installazione nel terreno.
- SUPPORTO per la versione a luce doppia.

**TOMMY**



**Dimensions and weight**

Height: 165 mm  
Width: 152 mm  
Weight: 0,45 Kg

**Moulded Colours:**

Black Grey White

**Diffuser PC:**

Frosted  
Blue Green Orange

**GX53 LED**

\*ADD. SUFFIX



	<b>3 W</b>	<b>350 Lm</b>	4000 K .G1L
			3000 K .G1R
	<b>7 W</b>	<b>800 Lm</b>	4000 K .C1L
			3000 K .C1R
	<b>10 W</b>	<b>1200 Lm</b>	4000 K .D1L
			3000 K .D1R

**LED LAMPS**



More technical details about TÜV approved Fumagalli LED Lamps on page 468.

Floodlight supplied as standard with TÜV approved, long-life and efficient **GX53 LED lamp** included. Different wattages available. Quick and easy lamp replacement for a very simple maintenance after installation.

- **COST SAVING:** long-life and efficient LED light sources
- **BUILT-IN DRIVER:** quick and easy lamp replacement
- **GREAT FLEXIBILITY:** GX53 standard lamp holder
- **FUTURE-PROOFED LUMINARIES:** performances easy to upgrade to latest technology developments
- **SUITABLE FOR OUTDOOR USE:** built-in driver fully protected against heat and humidity by silicone paste.

**3W 350 Lm** = **40W** incandescent  
**SAVE 90%**

**7W 10W** = **75W 100W** incandescent  
**SAVE 90%**

\*ADD THESE SUFFIXES TO THE REFERENCES MENTIONED IN THE CATALOGUE

**TOMMY**  
FLOODLIGHT

BULKHEAD

FLOODLIGHT

IN-GROUND

BRICKLIGHT

BOLLARDS

GARDEN

URBAN CLASSIC

URBAN MODERN

HIGH-BAY

POST

LAMPS



2M1.000.D1L



4M1.001.AUD2L



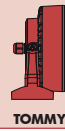

TOMMY		
2M1.000.G1L	<b>3W</b>	2M1.000.G1R
2M1.000.C1L	<b>7W</b>	2M1.000.C1R
2M1.000.D1L	<b>10W</b>	2M1.000.D1R
4000K	GX53 LED LAMP INCLUDED	3000K

Pcs 18  
Kg 14  
mc 0,092

TOMMY SPIKE		
2M1.001.G1L	<b>3W</b>	2M1.001.G1R
2M1.001.C1L	<b>7W</b>	2M1.001.C1R
2M1.001.D1L	<b>10W</b>	2M1.001.D1R
4000K	GX53 LED LAMP INCLUDED	3000K

Pcs 18  
Kg 15  
mc 0,092

TOMMY 2L		
4M1.000.G2L	<b>6W</b>	4M1.000.G2R
4M1.000.C2L	<b>14W</b>	4M1.000.C2R
4M1.000.D2L	<b>20W</b>	4M1.000.D2R
4000K	2 GX53 LED LAMPS INCLUDED	3000K

Pcs 8  
Kg 13  
mc 0,092

TOMMY 2L SPIKE		
4M1.001.G2L	<b>6W</b>	4M1.001.G2R
4M1.001.C2L	<b>14W</b>	4M1.001.C2R
4M1.001.D2L	<b>20W</b>	4M1.001.D2R
4000K	2 GX53 LED LAMPS INCLUDED	3000K

Pcs 8  
Kg 14  
mc 0,092

BULKHEAD

FLOODLIGHT

IN-GROUND

BRICKLIGHT

BOLLARDS

GARDEN

URBAN CLASSIC

URBAN MODERN

HIGH-BAY

POST

LAMPS



MADE IN  
ITALY

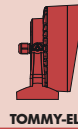

TOMMY-EL		
2M2.000.G1L	<b>3W</b>	2M2.000.G1R
2M2.000.C1L	<b>7W</b>	2M2.000.C1R
2M2.000.D1L	<b>10W</b>	2M2.000.D1R
4000K	GX53 LED LAMP INCLUDED	3000K

Pcs 18  
Kg 14  
mc 0,092

TOMMY-EL SPIKE		
2M2.001.G1L	<b>3W</b>	2M2.001.G1R
2M2.001.C1L	<b>7W</b>	2M2.001.C1R
2M2.001.D1L	<b>10W</b>	2M2.001.D1R
4000K	GX53 LED LAMP INCLUDED	3000K

Pcs 18  
Kg 15  
mc 0,092

TOMMY-EL 2L		
4M2.000.G2L	<b>6W</b>	4M2.000.G2R
4M2.000.C2L	<b>14W</b>	4M2.000.C2R
4M2.000.D2L	<b>20W</b>	4M2.000.D2R
4000K	2 GX53 LED LAMPS INCLUDED	3000K

Pcs 8  
Kg 13  
mc 0,092

TOMMY-EL 2L SPIKE		
4M2.001.G2L	<b>6W</b>	4M2.001.G2R
4M2.001.C2L	<b>14W</b>	4M2.001.C2R
4M2.001.D2L	<b>20W</b>	4M2.001.D2R
4000K	2 GX53 LED LAMPS INCLUDED	3000K

Pcs 8  
Kg 14  
mc 0,092

**TOMMY-SQ**  
FLOODLIGHT

BULKHEAD

FLOODLIGHT

IN-GROUND

BRICKLIGHT

BOLLARDS

GARDEN

URBAN CLASSIC

URBAN MODERN

HIGH-BAY

POST

LAMPS





MINITOMMY



TOMMY-SQ

TOMMY-SQ		
5M1.000.G1L	<b>3W</b>	5M1.000.G1R
5M1.000.C1L	<b>7W</b>	5M1.000.C1R
5M1.000.D1L	<b>10W</b>	5M1.000.D1R
4000K	GX53 LED LAMP INCLUDED	3000K

Pcs 18  
Kg 14  
mc 0,092

TOMMY-SQ SPIKE		
5M1.001.G1L	<b>3W</b>	5M1.001.G1R
5M1.001.C1L	<b>7W</b>	5M1.001.C1R
5M1.001.D1L	<b>10W</b>	5M1.001.D1R
4000K	GX53 LED LAMP INCLUDED	3000K

Pcs 18  
Kg 15  
mc 0,092

TOMMY-SQ 2L		
6M1.000.G2L	<b>6W</b>	6M1.000.G2R
6M1.000.C2L	<b>14W</b>	6M1.000.C2R
6M1.000.D2L	<b>20W</b>	6M1.000.D2R
4000K	2 GX53 LED LAMPS INCLUDED	3000K

Pcs 8  
Kg 13  
mc 0,092

TOMMY-SQ 2L SPIKE		
6M1.001.G2L	<b>6W</b>	6M1.001.G2R
6M1.001.C2L	<b>14W</b>	6M1.001.C2R
6M1.001.D2L	<b>20W</b>	6M1.001.D2R
4000K	2 GX53 LED LAMPS INCLUDED	3000K

Pcs 8  
Kg 14  
mc 0,092



# GIOVA/GERMANA FLOODLIGHT

Rectangular floodlight with no visible screws made in shockproof resin material, UV-rays stabilized, rust and corrosion-free. Suitable for wall and ground installation. Provided complete with a fully adjustable bracket to direct the light emission. Supplied with TÜV approved, long-life and efficient **GX53 LED lamps included** or provided with **E27** lampholder. Motion sensor version available. Insulation class II, Protection rating IP66.



*Proiettore rettangolare senza viti a vista, fabbricato in resina antiurto stabilizzata ai raggi UV, inattaccabile da ruggine e corrosione. Idoneo per installazioni a parete, al suolo e a palo. Il proiettore si può inclinare e orientare a piacimento con l'ausilio di un braccio opzionale. Provvisto di lampadine a LED GX53 approvate TÜV di lunga durata ed elevata efficienza o fornito nella versione E27. Disponibile anche con sensore di movimento. Classe di isolamento II, grado di protezione IP66.*



2N1.702.C2L

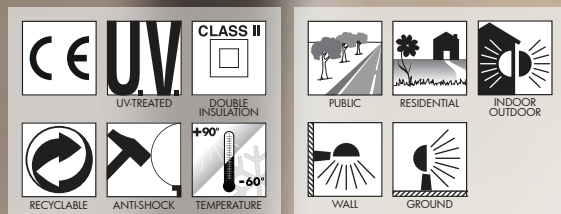

BULKHEAD  
FLOODLIGHT  
IN-GROUND  
BRICKLIGHT  
BOLLARDS  
GARDEN  
URBAN CLASSIC  
URBAN MODERN  
HIGH-BAY  
POST  
LAMPS

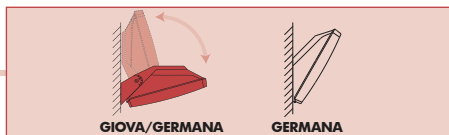

**GIOVA/GERMANA - COMPONENTS**

IP66



**COVER** with no visible screws, made of shockproof resin material, UV-rays stabilized.

**COVER** senza viti a vista in resina antiurto stabilizzata ai raggi UV.

**DIFFUSER** made of UV-rays stabilized polymethylmethacrylate (PMMA) screwed to the floodlight body.

**DIFFUSORE** realizzato in polimetilmetacrilato (PMMA) stabilizzato ai raggi UV da avvitare al corpo del proiettore.

**BODY** made of shockproof resin material, UV-rays stabilized, provided with silicone rubber gasket to ensure high protection against external agents.

**CORPO** realizzato in resina antiurto, stabilizzata ai raggi UV, completa di guarnizione in gomma siliconica per garantire un alto livello di protezione contro gli agenti esterni.

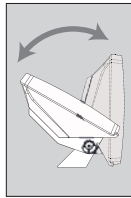

**BRACKET** made of shockproof resin material, UV-rays stabilized, to allow a fully adjustable position of the floodlight.

**BRACCIO** realizzato in resina antiurto, stabilizzato ai raggi UV, che permette l'orientamento in qualsiasi posizione del proiettore

**GIOVA/GERMANA**



**Dimensions and weight**

Height: 280 mm  
Width: 180 mm  
Weight: 0,45 Kg

**Moulded Colours:**

Black  Grey  White

**Diffuser PC:**

Opal  Frosted (upon request)



**2x GX53 LED**



FULLY PRE-WIRED

Floodlight supplied **fully pre-wired** complete with TÜV approved, long-life and efficient **2x GX53 LED lamps included**. Different wattages available. Quick and easy lamp replacement for a very simple maintenance after installation.

\*ADD. SUFFIX

	2x 3W <b>6W</b>	<b>700 Lm</b>	4000 K .G2L
			3000 K .G2R
	2x 7W <b>14W</b>	<b>1600 Lm</b>	4000 K .C2L
			3000 K .C2R
	2x 10W <b>20W</b>	<b>2400 Lm</b>	4000 K .D2L
			3000 K .D2R

**E27**



FULLY PRE-WIRED

Floodlight supplied **fully pre-wired** with white resin reflective ceiling and complete with **E27 lampholder**. Daylight and motion sensor available as option. Sensor operating voltage: 220-240V. (120V version available on demand).

\*ADD. SUFFIX

<b>E27</b> (CFL-LED)	max 160 mm ↔	.P27
<b>E27 + Sensor</b> (CFL-LED) 	max 160 mm ↔	.PS7

**LED LAMPS**



More technical details about TÜV approved Fumagalli LED Lamps on page 468.

\* ADD THESE SUFFIXES TO THE REFERENCES MENTIONED IN THE CATALOGUE

2x 10W  
2.400 Lm

= 50W  
SON-HQI



**SAVE 60%**

**GIOVA/GERMANA**  
FLOODLIGHT

BULKHEAD

FLOODLIGHT

IN-GROUND

BRICKLIGHT

BOLLARDS

GARDEN

URBAN CLASSIC

URBAN MODERN

HIGH-BAY

POST

LAMPS



MADE IN  
ITALY

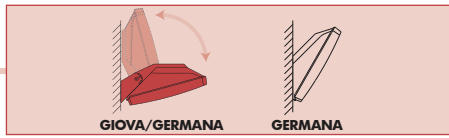

GIOVA/GERMANA		
2N1.702.G2L	<b>6W</b>	2N1.702.G2R
2N1.702.C2L	<b>14W</b>	2N1.702.C2R
2N1.702.D2L	<b>20W</b>	2N1.702.D2R
4000K	2x GX53 LED LAMP INCLUDED	3000K
Pcs 18 Kg 26 mc 0,198		
<b>E27</b>	2N1.702.P27	
<b>E27 with sensor</b>	2N1.702.PS7	

# GERMANA FLOODLIGHT

Rectangular floodlight with no visible screws made of shockproof resin material, UV-rays stabilized, rust and corrosion-free. Suitable for wall, ground and post installation. A fully adjustable bracket is available as option to direct the light emission. Supplied with TÜV approved, long-life and efficient **GX53 LED lamps included** or provided with **E27** lampholder. Motion sensor version available. Insulation class II, Protection rating IP66.



*Proiettore rettangolare senza viti a vista, fabbricato in resina antiurto stabilizzata ai raggi UV, inattaccabile da ruggine e corrosione. Idoneo per installazioni a parete, al suolo e a palo. Il proiettore si può inclinare e orientare a piacimento con l'ausilio di un braccio opzionale. Provvisto di lampadine a LED GX53 approvate TÜV di lunga durata ed elevata efficienza o fornito nella versione E27. Disponibile anche con sensore di movimento. Classe di isolamento II, grado di protezione IP66.*



2N1.000.C2L

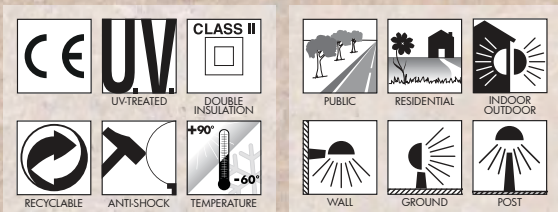

BULKHEAD  
FLOODLIGHT  
IN-GROUND  
BRICKLIGHT  
BOLLARDS  
GARDEN  
URBAN CLASSIC  
URBAN MODERN  
HIGH-BAY  
POST  
LAMPS

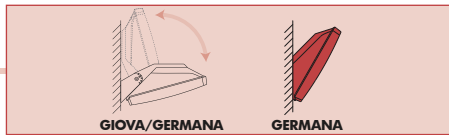

**GERMANA - COMPONENTS**

IP66



**COVER** with no visible screws, made of shockproof resin material, UV-rays stabilized.

*COVER senza viti a vista in resina antiurto stabilizzata ai raggi UV.*

**DIFFUSER** made of UV-rays stabilized polymethyl-methacrylate (PMMA) screwed to the floodlight body.

*DIFFUSORE realizzato in polimetilmetacrilato (PMMA) stabilizzato ai raggi UV da avvitare al corpo del proiettore.*

**BODY** made of shockproof resin material, UV-rays stabilized, provided with silicone rubber gasket to ensure high protection against external agents.

*CORPO realizzato in resina antiurto, stabilizzata ai raggi UV, completa di guarnizione in gomma siliconica per garantire un alto livello di protezione contro gli agenti esterni.*

**GERMANA**



**Dimensions and weight**

Height: 280 mm  
Width: 180 mm  
Weight: 0,45 Kg

**Moulded Colours:**

Black Grey White

**Diffuser PC:**

Opal Frosted (upon request)

**2x GX53 LED**



Version supplied **fully pre-wired** complete with TÜV approved, long-life and efficient **2x GX53 LED lamps included**. Different wattages available. Quick and easy lamp replacement for a very simple maintenance after installation.

\*ADD. SUFFIX

**E27**



Version supplied **fully pre-wired** with white resin reflective ceiling and complete with **E27 lampholder**. Daylight and motion sensor available as option. Sensor operating voltage: 220-240V. (120V version available on demand).

\*ADD. SUFFIX

**POST VERSION**



Detailed information on next page.

	2x 3W <b>6W</b>	<b>700 Lm</b>	4000 K .G2L
			3000 K .G2R
	2x 7W <b>14W</b>	<b>1600 Lm</b>	4000 K .C2L
			3000 K .C2R
	2x 10W <b>20W</b>	<b>2400 Lm</b>	4000 K .D2L
			3000 K .D2R

<b>E27</b> (CFL -LED)	max 160 mm ↔	.P27
<b>E27 + Sensor</b> (CFL -LED)	max 160 mm ↔	.P57

\* ADD THESE SUFFIXES TO THE REFERENCES MENTIONED IN THE CATALOGUE

**2x 10W = 50W**  
**2.400 Lm** SON-HQI

**SAVE 60%**

**LED LAMPS**



More technical details about TÜV approved Fumagalli LED Lamps on page 468.

BULKHEAD  
FLOODLIGHT  
IN-GROUND  
BRICKLIGHT  
BOLLARDS  
GARDEN  
URBAN CLASSIC  
URBAN MODERN  
HIGH-BAY  
POST  
LAMPS



MADE IN  
ITALY

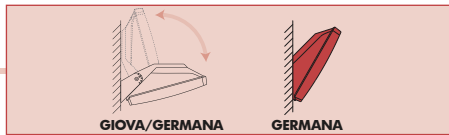

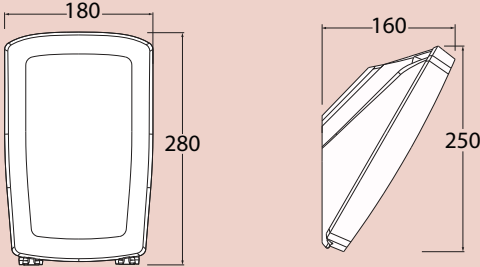
GERMANA		
2N1.000.G2L	<b>6W</b>	2N1.000.G2R
2N1.000.C2L	<b>14W</b>	2N1.000.C2R
2N1.000.D2L	<b>20W</b>	2N1.000.D2R
4000K	2x GX53 LED LAMP INCLUDED	3000K
		
Pcs 18 Kg 25 mc 0,198		
<b>E27</b>	2N1.000.P27	
<b>E27 with sensor</b>	2N1.000.PS7	

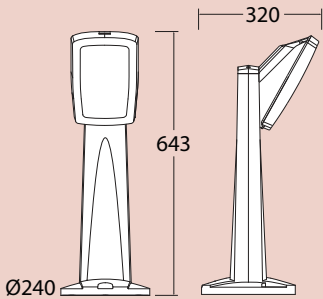
MINIPINELA 1L		
2N1.612.010.G2L	<b>6W</b>	2N1.612.010.G2R
2N1.612.010.C2L	<b>14W</b>	2N1.612.010.C2R
2N1.612.010.D2L	<b>20W</b>	2N1.612.010.D2R
4000K		3000K
		
Pcs 1 Kg 3,5 mc 0,06		
<b>E27</b>	2N1.612.010.P27	
<b>E27 with sensor</b>	2N1.612.010.PS7	

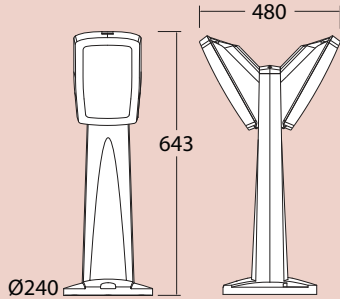
MINIPINELA 2L		
2N1.612.020.G2L	<b>2x6W</b>	2N1.612.020.G2R
2N1.612.020.C2L	<b>2x14W</b>	2N1.612.020.C2R
2N1.612.020.D2L	<b>2x20W</b>	2N1.612.020.D2R
4000K		3000K
		
Pcs 1 Kg 4 mc 0,06		
<b>E27</b>	2N1.612.020.P27	
<b>E27 with sensor</b>	2N1.612.020.PS7	

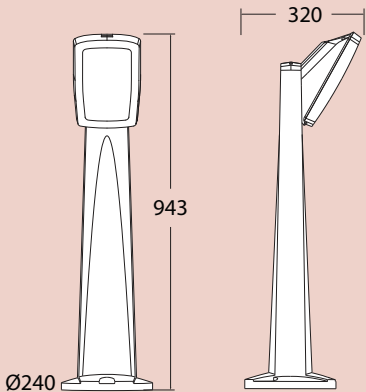
PINELA 1L		
2N1.613.010.C2L	<b>6W</b>	2N1.613.010.G2R
2N1.613.010.D2L	<b>14W</b>	2N1.613.010.C2R
2N1.613.010.D2L	<b>20W</b>	2N1.613.010.D2R
4000K		3000K
		
Pcs 1 Kg 4 mc 0,097		
<b>E27</b>	2N1.613.010.P27	
<b>E27 with sensor</b>	2N1.613.010.PS7	

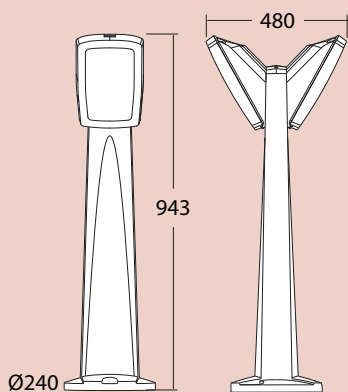
PINELA 2L		
2N1.613.020.C2L	<b>2x6W</b>	2N1.613.020.G2R
2N1.613.020.D2L	<b>2x14W</b>	2N1.613.020.C2R
2N1.613.020.D2L	<b>2x20W</b>	2N1.613.020.D2R
4000K		3000K
		
Pcs 1 Kg 5 mc 0,097		
<b>E27</b>	2N1.613.020.P27	
<b>E27 with sensor</b>	2N1.613.020.PS7	



# GIOVA/GIUSEPPE FLOODLIGHT

BULKHEAD  
FLOODLIGHT  
IN-GROUND  
BRICKLIGHT  
BOLLARDS  
GARDEN  
URBAN CLASSIC  
URBAN MODERN  
HIGH-BAY  
POST  
LAMPS

Square floodlight with no visible screws made of shockproof resin material, UV-rays stabilized, rust and corrosion-free. Suitable for wall, ceiling, ground and post installation. A fully adjustable bracket is available as option to direct the light emission. Supplied with TÜV approved, long-life and efficient **GX53 LED lamps included** or provided with **2x E27 lampholders**. Motion sensor version available. Insulation class II, Protection rating IP66.



GIOVA/GIUSEPPE  
4P1.702  
4P2.702

*Proiettore quadro senza viti a vista, fabbricato in resina antiurto stabilizzata ai raggi UV, inattaccabile da ruggine e corrosione. Idoneo per installazioni a parete, a soffitto, al suolo e a palo. Il proiettore si può inclinare e orientare a piacimento con l'ausilio di un braccio opzionale. Provvisto di lampadine a LED GX53 approvate TÜV di lunga durata ed elevata efficienza o fornito nella versione 2x E27. Disponibile anche con sensore di movimento. Classe di isolamento II, grado di protezione IP66.*

4P1.702.B1L

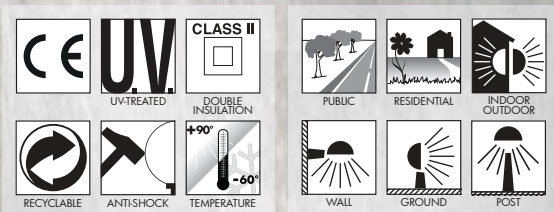

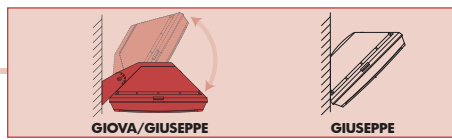

**GIOVA/GIUSEPPE - COMPONENTS**

IP66



**COVER** with no visible screws, made of shockproof resin material, UV-rays stabilized.

**COVER** senza viti a vista in resina antiurto stabilizzata ai raggi UV.

**DIFFUSER** made of UV-rays stabilized polymethylmethacrylate (PMMA) screwed to the floodlight body.

**DIFFUSORE** realizzato in polimetilmetacrilato (PMMA) stabilizzato ai raggi UV da avvitare al corpo del proiettore.

**BODY** made of shockproof resin material, UV-rays stabilized, provided with silicone rubber gasket to ensure high protection against external agents.

**CORPO** realizzato in resina antiurto, stabilizzata ai raggi UV, completa di guarnizione in gomma siliconica per garantire un alto livello di protezione contro gli agenti esterni.

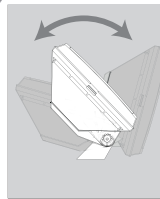

**BRACKET** made of shockproof resin material, UV-rays stabilized, to allow a fully adjustable position of the floodlight.

**BRACCIO** realizzato in resina antiurto, stabilizzato ai raggi UV, che permette l'orientamento in qualsiasi posizione del proiettore.

**GIOVA/GIUSEPPE**

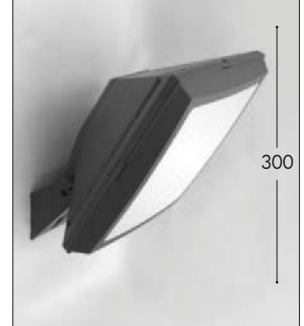

**Dimensions and weight**

Height: 150 mm  
Width: 300 mm  
Weight: 2,6 Kg

**Moulded Colours:**

Black Grey White

**Diffuser PC:**

Opal Frosted (upon request)

**LED LAMPS**



More technical details about TÜV approved Fumagalli LED Lamps on page 468.

**4x GX53 LED**

FULLY PRE-WIRED



4P2.702

Floodlight supplied with white resin reflective ceiling fully pre-wired and complete with TÜV approved long-life and efficient 4x GX53 LED lamps included. Different wattages available. Quick and easy lamp replacement for a very simple maintenance after installation.

\*ADD. SUFFIX

	4x 7W 28W	3200 Lm	4000 K	.C4L
			3000 K	.C4R
	4x 10W 40W	4800 Lm	4000 K	.D4L
			3000 K	.D4R

 **4x 10W** = **100W**  
**4800 Lm** SON-HQI

**SAVE 60%**

**GX53 LED**





FULLY PRE-WIRED



4P1.702

Floodlight supplied fully pre-wired and complete with TÜV approved, long-life and efficient GX53 LED lamp in different wattages. Quick and easy lamp replacement for a very simple maintenance after installation. Sensor available as option.

\*ADD. SUFFIX

	<b>11 W</b>	<b>1300 Lm</b>	4000 K	.B1L
			3000 K	.B1R
	<b>18 W</b>	<b>2000 Lm</b>	4000 K	.E1L
			3000 K	.E1R
	<b>11 W + SENSOR</b>	<b>1300 Lm</b>	4000 K	.BSL
			3000 K	.BSR
	<b>18 W + SENSOR</b>	<b>2000 Lm</b>	4000 K	.ESL
			3000 K	.ESR

 **11W**  
**18W** = **100W**  
incandescent

**SAVE 90%**

**2x E27**

FULLY PRE-WIRED



4P2.702

Floodlight supplied fully pre-wired with white resin reflective ceiling and complete with 2x E27 lampholders. Daylight and motion sensor available as option. Sensor operating voltage: 220-240V. (120V version available on demand).

\*ADD. SUFFIX

<b>2x E27</b> (CFL -LED)	max 160 mm	.E28
<b>2x E27</b> + SENSOR	max 160 mm	.E58

\* ADD THESE SUFFIXES TO THE REFERENCES MENTIONED IN THE CATALOGUE

**POST SYSTEM VERSION**



Detailed information on page 340.

**GIOVA/GIUSEPPE**  
FLOODLIGHT

BULKHEAD

FLOODLIGHT

IN-GROUND

BRICKLIGHT

BOLLARDS

GARDEN

URBAN CLASSIC

URBAN MODERN

HIGH-BAY

POST

LAMPS



4P2.702.D4L



4P2.702.D4L

MADE IN  
ITALY

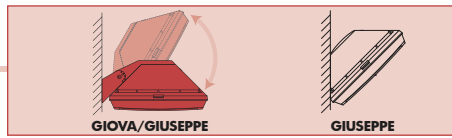

GIOVA/GIUSEPPE		
4P2.702.C4L	<b>28W</b>	4P2.702.C4R
4P2.702.D4L	<b>40W</b>	4P2.702.D4R
4P1.702.B1L	<b>11W</b>	4P1.702.B1R
4P1.702.E1L	<b>18W</b>	4P1.702.E1R
4000K	GX53 LED LAMP INCLUDED	3000K
<small>Pcs 10 Kg 26 mc 0,195</small>		
<b>2xE27</b>	4P2.702.E28	
<b>2xE27 with sensor</b>	4P2.702.ES8	



# GIUSEPPE FLOODLIGHT

Square floodlight with no visible screws made of shockproof resin material, UV-rays stabilized, rust and corrosion-free. Suitable for wall, ceiling, ground and post installation. A fully adjustable bracket is available as option to direct the light emission. Supplied with TÜV approved, long-life and efficient **GX53 LED lamps included** or provided with **2x E27 lampholders**. Motion sensor version available. Insulation class II, Protection rating IP66.



*Proiettore quadro senza viti a vista, fabbricato in resina antiurto stabilizzata ai raggi UV, inattaccabile da ruggine e corrosione. Idoneo per installazioni a parete, a soffitto, al suolo e a palo. Il proiettore si può inclinare e orientare a piacimento con l'ausilio di un braccio opzionale. Provvisto di lampadine a LED GX53 approvate TÜV di lunga durata ed elevata efficienza o fornito nella versione 2x E27. Disponibile anche con sensore di movimento. Classe di isolamento II, grado di protezione IP66.*



4P2.000.D4L

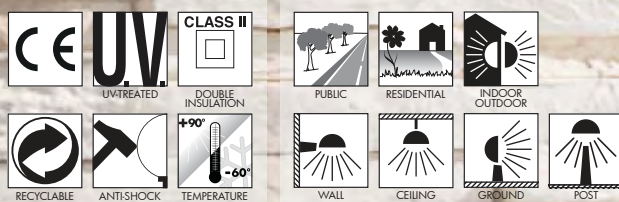

BULKHEAD

FLOODLIGHT

IN-GROUND

BRICKLIGHT

BOLLARDS

GARDEN

URBAN CLASSIC

URBAN MODERN

HIGH-BAY

POST

LAMPS

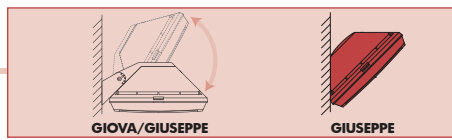

**GIUSEPPE - COMPONENTS**

IP 66



**COVER** with no visible screws, made of shockproof resin material, UV-rays stabilized.

**COVER** senza viti a vista in resina antiurto stabilizzata ai raggi UV.

**DIFFUSER** made of UV-rays stabilized polymethyl-methacrylate (PMMA) screwed to the floodlight body.

**DIFFUSORE** realizzato in polimetilmetacrilato (PMMA) stabilizzato ai raggi UV da avvitare al corpo del proiettore.

**BODY** made of shockproof resin material, UV-rays stabilized, provided with silicone rubber gasket to ensure high protection against external agents.

**CORPO** realizzato in resina antiurto, stabilizzata ai raggi UV, completa di guarnizione in gomma siliconica per garantire un alto livello di protezione contro gli agenti esterni.

**GIUSEPPE**



**Dimensions and weight**

Height: 150 mm  
Width: 300 mm  
Weight: 2,6 Kg

**Moulded Colours:**

Black Grey White

**Diffuser PC:**

Opal Frosted (upon request)

**LED LAMPS**



More technical details about TÜV approved Fumagalli LED Lamps on page 468.

**4x GX53 LED**

FULLY PRE-WIRED



4P2.000

Floodlight supplied with white resin reflective ceiling fully pre-wired and complete with TÜV approved long-life and efficient 4x GX53 LED lamps included. Different wattages available. Quick and easy lamp replacement for a very simple maintenance after installation.

\*ADD. SUFFIX

	4x 7W 28W	3200 Lm	4000 K	.C4L
			3000 K	.C4R
	4x 10W 40W	4800 Lm	4000 K	.D4L
			3000 K	.D4R

4x 10W = 100W SON-HQI 4800 Lm **SAVE 60%**

**GX53 LED**

FULLY PRE-WIRED



4P1.000

Floodlight supplied fully pre-wired and complete with TÜV approved, long-life and efficient GX53 LED lamp in different wattages. Quick and easy lamp replacement for a very simple maintenance after installation. Sensor available as option.

\*ADD. SUFFIX

	11 W	1300 Lm	4000 K	.B1L
	18 W	2000 Lm	3000 K	.B1R
	11 W + SENSOR	1300 Lm	4000 K	.E1L
	18 W + SENSOR	2000 Lm	3000 K	.E1R
	11 W	1300 Lm	4000 K	.BSL
	18 W	2000 Lm	3000 K	.BSR
	11 W	1300 Lm	4000 K	.ESL
	18 W	2000 Lm	3000 K	.ESR

11W 18W = 100W incandescent **SAVE 90%**

**2x E27**

FULLY PRE-WIRED



4P2.000

Floodlight supplied fully pre-wired with white resin reflective ceiling and complete with 2x E27 lampholders. Daylight and motion sensor available as option. Sensor operating voltage: 220-240V. (120V version available on demand).

\*ADD. SUFFIX

2x E27 (CFL-LED)	max 160 mm	.E28
2x E27 + SENSOR	max 160 mm	.ES8

\* ADD THESE SUFFIXES TO THE REFERENCES MENTIONED IN THE CATALOGUE

**POST VERSION**



Detailed information on next page.

\* ADD THESE SUFFIXES TO THE REFERENCES MENTIONED IN THE CATALOGUE

BULKHEAD  
FLOODLIGHT  
IN-GROUND  
BRICKLIGHT  
BOLLARDS  
GARDEN  
URBAN CLASSIC  
URBAN MODERN  
HIGH-BAY  
POST  
LAMPS



MADE IN  
ITALY

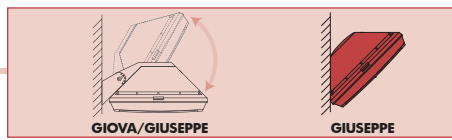

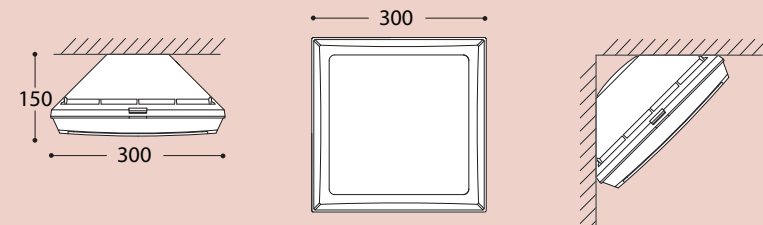
GIUSEPPE		
4P1.000.B1L	<b>11W</b>	4P1.000.B1R
4P1.000.E1L	<b>18W</b>	4P1.000.E1R
4P2.000.C4L	<b>28W</b>	4P2.000.C4R
4P2.000.D4L	<b>40W</b>	4P2.000.D4R
4000K	GX53 LED LAMP INCLUDED	3000K
		
Pcs 10 Kg 25 mc 0,195		
<b>2xE27</b>		4P2.000.E28
<b>2xE27 with sensor</b>		4P2.000.ES8

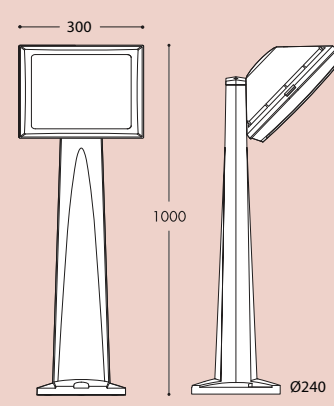
PINA 1L		
4P1.613.010.B1L	<b>11W</b>	4P1.613.010.B1R
4P1.613.010.E1L	<b>18W</b>	4P1.613.010.E1R
4P2.613.010.C4L	<b>28W</b>	4P2.613.010.C4R
4P2.613.010.D4L	<b>40W</b>	4P2.613.010.D4R
4000K		3000K
		
Pcs 1 Kg 4,5 mc 0,097		
<b>2xE27</b>	4P2.613.010.E28	
<b>2xE27 with sensor</b>	4P2.613.010.ES8	

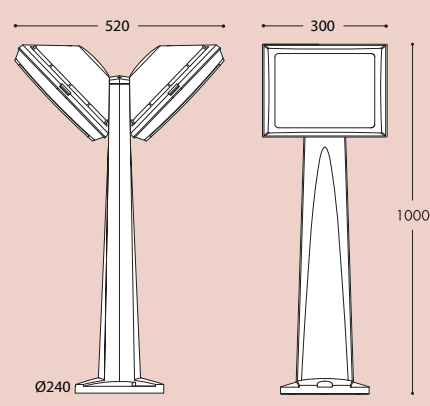
PINA 2L		
4P1.613.020.B1L	<b>2x 11W</b>	4P1.613.020.B1R
4P1.613.020.E1L	<b>2x 18W</b>	4P1.613.020.E1R
4P2.613.020.C4L	<b>2x 28W</b>	4P2.613.020.C4R
4P2.613.020.D4L	<b>2x 40W</b>	4P2.613.020.D4R
4000K		3000K
		
Pcs 1 Kg 7 mc 0,097		
<b>2xE27</b>	4P2.613.020.E28	
<b>2xE27 with sensor</b>	4P2.613.020.ES8	



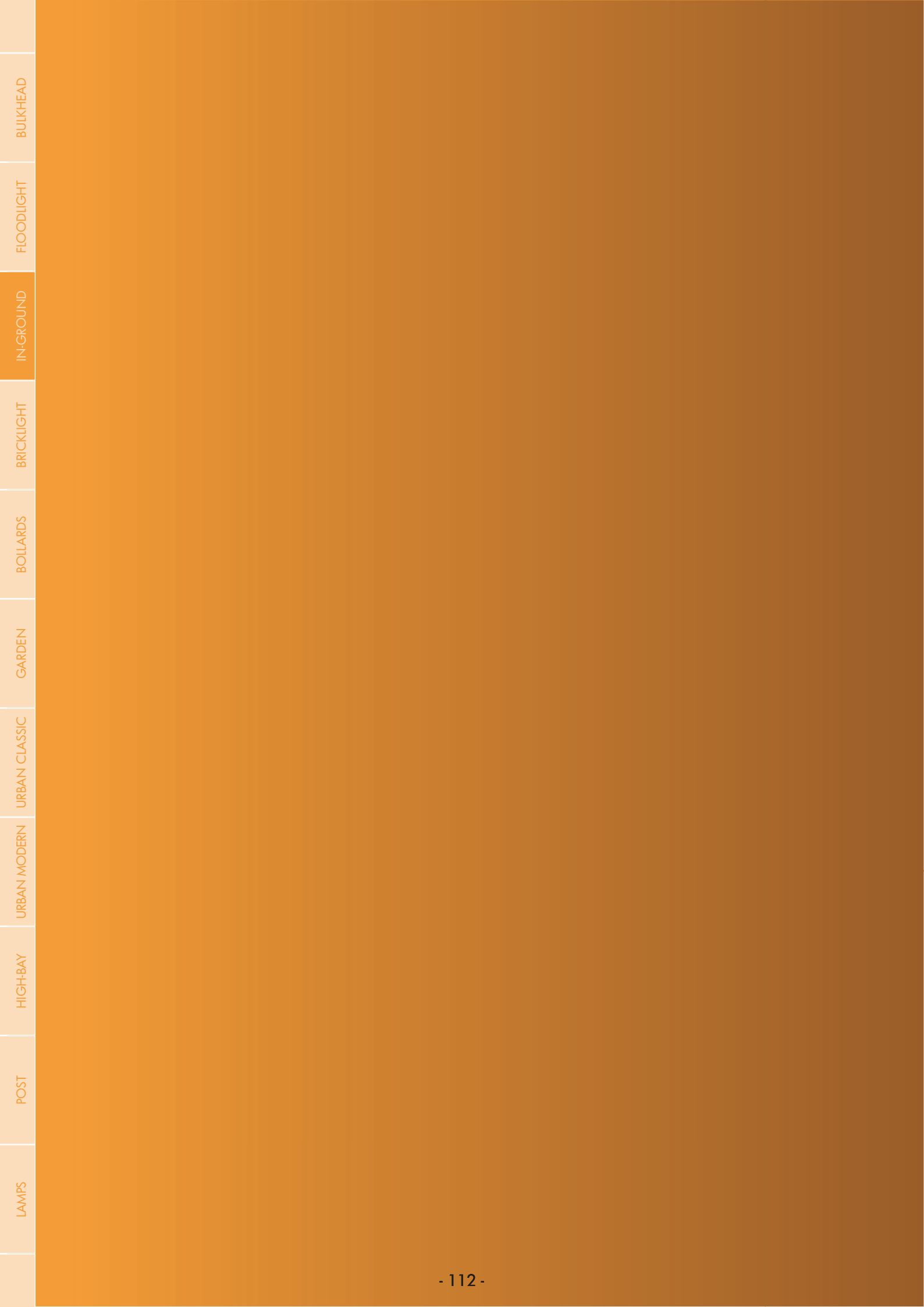

BULKHEAD

FLOODLIGHT

IN-GROUND

BRICKLIGHT

BOLLARDS

GARDEN

URBAN CLASSIC

URBAN MODERN

HIGH-BAY

POST

LAMPS



# IN-GROUND

BULKHEAD

FLOODLIGHT

BRICKLIGHT

BOLLARDS

GARDEN

URBAN CLASSIC

URBAN MODERN

HIGH-BAY

POST

LAMPS

# CECI 90 IN-GROUND

BULKHEAD  
FLOODLIGHT  
IN-GROUND  
BRICKLIGHT  
BOLLARDS  
GARDEN  
URBAN CLASSIC  
URBAN MODERN  
HIGH-BAY  
POST  
LAMPS

DRIVE-OVER (pressure load up to 5.000 Kg.) in-ground luminaries with no visible screws, made of shockproof resin material, UV-rays stabilized, rust and corrosion-free. Round or square shape available with several cover versions. Supplied as standard with TÜV approved, long-life and efficient **GU10 LED lamp included**. Insulation class II, Protection rating IP67.



*Apparecchio per incasso a terra CARRABILE (carico di pressione fino a 5.000Kg.) e senza viti a vista, realizzato in resina antiurto, stabilizzata ai raggi UV, inattaccabile da ruggine e corrosione. Disponibile con forma quadrata o circolare in diverse versioni di cover. Fornito con inclusa lampadina a LED GU10 approvata TÜV, di lunga durata ed elevata efficienza. Classe di isolamento II, grado di protezione IP67.*



1F1.000.U1L





CECI 90



CECI 120



CECI 160

**CECI 90 - COMPONENTS**



**IP67**



**COVER** with no visible screws made of shockproof resin material, UV rays stabilized, rust and corrosion free. Round or square design, 2 or 3 light versions available for a diffuse or directed light emission.



DRIVE-OVER  
5000 KG

**COVER** senza viti a vista realizzata in resina antiurto, stabilizzata ai raggi UV, inattaccabile da ruggine e corrosione. Disponibile nelle versioni quadrata o ad anello, a 2 aperture e a 3 aperture per permettere un'emissione della luce diffusa o direzionata.

**DIFFUSER** made of high impact and high-pressure load resistant resin material (PC), complete with silicone rubber gasket to ensure high protection against external agents. Frosted or coloured versions, to get a customized ambience.

**DIFFUSORE** in resina antiurto altamente resistente al carico (PC), completo di guarnizione in gomma siliconica per garantire un alto livello di protezione contro gli agenti esterni. Disponibile nella versione satinata o colorata, per ottenere un'ambientazione personalizzata.



**HOUSING** made of shockproof resin material, provided with double holes and double watertight cable glands for safe connecting cable.

**CASSA** realizzata in resina antiurto, provvista di doppi fori e doppio pressacavo a tenuta stagna, per consentire in maniera sicura l'ingresso e l'uscita delle connessioni elettriche.

**INSTALLATION HOUSING** made of shockproof resin material to be fixed into the ground before installing the luminaries.

**CONTRO-CASSA** in resina antiurto da fissare al suolo prima dell'installazione degli apparecchi.

**CECI 90**



**Dimensions and weight**

Installation housing depth: 127 mm  
Diameter: Ø 92 mm  
Weight: 0,45 Kg

**Cover colours:**

Black Grey

**Diffuser PC:**

Frosted  
Blue Green Orange

**GU10 LED**

\*ADD SUFFIX

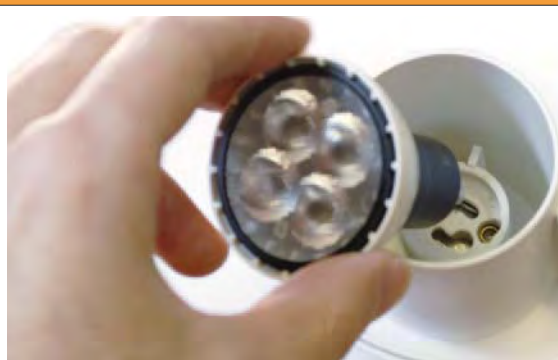

GU10  
LED

**4,5 W**

**300 Lm**

4000 K .U1L

3000 K .U1R

In-ground supplied as standard with TÜV approved, long-life and efficient **GU10 LED lamp included**. Quick and easy lamp replacement for a very simple maintenance after installation.

- **COST SAVING:** long-life and efficient LED light sources
- **BUILT-IN DRIVER:** quick and easy lamp replacement
- **GREAT FLEXIBILITY:** GU10 standard lamp holder
- **FUTURE-PROOFED LUMINARIES:** performances easy to upgrade to latest technology developments
- **SUITABLE FOR OUTDOOR USE:** built-in driver fully protected against heat and humidity by silicone paste.



**4.5W** = **35W**  
**300 Lm** HALOGEN  
**SAVE 85%**

**LED LAMPS**



More technical details about TÜV approved Fumagalli LED Lamps on page 468.

\*ADD THESE SUFFIXES TO THE REFERENCES MENTIONED IN THE CATALOGUE



**MADE IN ITALY**

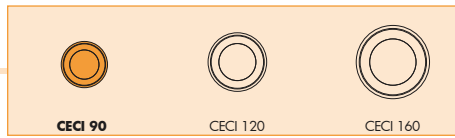

**CECI 90**

1F1.000.U1L	<b>4,5W</b>	1F1.000.U1R
4000K	GU10 LED LAMP INCLUDED	3000K

Pcs 40  
Kg 24  
mc 0,084

**CECI 90-3L**

1F3.000.U1L	<b>4,5W</b>	1F3.000.U1R
4000K	GU10 LED LAMP INCLUDED	3000K

Pcs 40  
Kg 24  
mc 0,084

**CECI 90-2L**

1F2.000.U1L	<b>4,5W</b>	1F2.000.U1R
4000K	GU10 LED LAMP INCLUDED	3000K

Pcs 40  
Kg 24  
mc 0,084

**CECI 90-SQ**

1F4.000.U1L	<b>4,5W</b>	1F4.000.U1R
4000K	GU10 LED LAMP INCLUDED	3000K

Pcs 40  
Kg 24  
mc 0,084

BULKHEAD

FLOODLIGHT

IN-GROUND

BRICKLIGHT

BOLLARDS

GARDEN

URBAN CLASSIC

URBAN MODERN

HIGH-BAY

POST

LAMPS

# CECI 120

## IN-GROUND

DRIVE-OVER (pressure load up to 5.000 Kg.) in-ground luminaries with no visible screws, made of shockproof resin material, UV-rays stabilized, rust and corrosion-free. Round or square shape available with several cover versions. Supplied as standard with TÜV approved, long-life and efficient **GX53 LED lamp 3W-350lm included**. Insulation class II, Protection rating IP67.



CECI 120  
2F1.000



CECI 120-2L  
2F2.000



CECI 120-3L  
2F3.000



CECI 120-SQ  
2F4.000

*Apparecchio per incasso a terra CARRABILE (carico di pressione fino a 5.000Kg.) e senza viti a vista, realizzato in resina antiurto, stabilizzata ai raggi UV, inattaccabile da ruggine e corrosione. Disponibile con forma quadrata o circolare in diverse versioni di cover. Fornito con inclusa **lampadina a LED GX53 3W-350lm** approvata TÜV, di lunga durata ed elevata efficienza. Classe di isolamento II, grado di protezione IP67.*



2F1.000.G1L

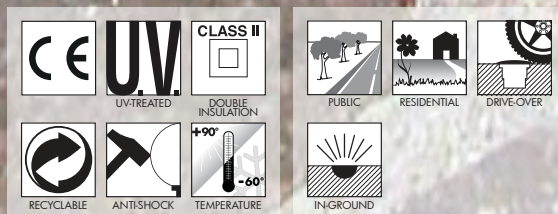

**CECI 120 - COMPONENTS**



**IP67**



**COVER** with no visible screws made of shockproof resin material, UV-rays stabilized, rust and corrosion free. Round or square design, 2 or 3 light versions available for a diffuse or directed light emission.



DRIVE-OVER  
5000 KG

**COVER** senza viti a vista realizzata in resina antiurto, stabilizzata ai raggi UV, inattaccabile da ruggine e corrosione. Disponibile nelle versioni quadrata o ad anello, a 2 aperture e a 3 aperture per permettere un'emissione della luce diffusa o direzionata.

**DIFFUSER** made of high impact and high-pressure load resistant resin material (PC), complete with silicone rubber gasket to ensure high protection against external agents. Frosted or coloured versions, to get a customized ambiance.

**DIFFUSORE** in resina antiurto altamente resistente al carico (PC), completo di guarnizione in gomma siliconica per garantire un alto livello di protezione contro gli agenti esterni. Disponibile nella versione satinata o colorata, per ottenere un'ambientazione personalizzata.



**HOUSING** made of shockproof resin material, provided with double holes and double watertight cable glands for safe connecting cable.

**CASSA** realizzata in resina antiurto, provvista di doppi fori e doppio pressacavo a tenuta stagna, per consentire in maniera sicura l'ingresso e l'uscita delle connessioni elettriche.

**INSTALLATION HOUSING** made of shockproof resin material to be fixed into the ground before installing the luminaries.

**CONTRO-CASSA** in resina antiurto da fissare al suolo prima dell'installazione degli apparecchi.

**CECI 120**



**Dimensions and weight**  
Installation housing depth: 93 mm  
Diameter: Ø 120 mm  
Weight: 0,45 Kg

**Cover colours:**



**Diffuser PC:**



**GX53 LED**

\*ADD SUFFIX



	<b>3 W</b>	<b>350 Lm</b>	4000 K	.G1L
			3000 K	.G1R

In-ground supplied as standard with TÜV approved, long-life and efficient GX53 LED lamp 3W-350lm included. Quick and easy lamp replacement for a very simple maintenance after installation.

- **COST SAVING:** long-life and efficient LED light sources
- **BUILT-IN DRIVER:** quick and easy lamp replacement
- **GREAT FLEXIBILITY:** GX53 standard lamp holder
- **FUTURE-PROOFED LUMINARIES:** performances easy to upgrade to latest technology developments.

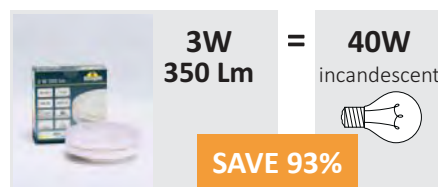

**LED LAMPS**



More technical details about TÜV approved Fumagalli LED Lamps on page 468.

\*ADD THESE SUFFIXES TO THE REFERENCES MENTIONED IN THE CATALOGUE



**CECI 120**  
**IN-GROUND**

BULKHEAD

FLOODLIGHT

IN-GROUND

BRICKLIGHT

BOLLARDS

GARDEN

URBAN CLASSIC

URBAN MODERN

HIGH-BAY

POST

LAMPS





**CECI 120**

2F1.000.G1L	<b>3W</b>	2F1.000.G1R
4000K	GX53 LED LAMP INCLUDED	3000K

Pcs 36  
Kg 23  
mc 0,084

**CECI 120-3L**

2F3.000.G1L	<b>3W</b>	2F3.000.G1R
4000K	GX53 LED LAMP INCLUDED	3000K

Pcs 36  
Kg 23  
mc 0,084

**CECI 120-2L**

2F2.000.G1L	<b>3W</b>	2F2.000.G1R
4000K	GX53 LED LAMP INCLUDED	3000K

Pcs 36  
Kg 23  
mc 0,084

**CECI 120-SQ**

2F4.000.G1L	<b>3W</b>	2F4.000.G1R
4000K	GX53 LED LAMP INCLUDED	3000K

Pcs 36  
Kg 23  
mc 0,084

# CECI 160

## IN-GROUND



BULKHEAD

FLOODLIGHT

IN-GROUND

BRICKLIGHT

BOLLARDS

GARDEN

URBAN CLASSIC

URBAN MODERN

HIGH-BAY

POST

LAMPS

DRIVE-OVER (pressure load up to 5.000 Kg.) in-ground luminaries with no visible screws, made of shockproof resin material, UV-rays stabilized, rust and corrosion-free. Round or square shape available with several cover versions. Supplied as standard with TÜV approved, long-life and efficient **GX53 LED lamp included**. Insulation class II, Protection rating IP67.



*Apparecchio per incasso a terra CARRABILE (carico di pressione fino a 5.000Kg.) e senza viti a vista, realizzato in resina antiurto, stabilizzata ai raggi UV, inattaccabile da ruggine e corrosione. Disponibile con forma quadrata o circolare in diverse versioni di cover. Fornito con inclusa lampadina a LED GX53 approvata TÜV, di lunga durata ed elevata efficienza. Classe di isolamento II, grado di protezione IP67.*



3F3.000.D1L



**CECI 160 - COMPONENTS**



**IP67**



**COVER** with no visible screws made of shockproof resin material, UV-rays stabilized, rust and corrosion free. Round or square design, 2 or 3 light versions available for a diffuse or directed light emission.



DRIVE-OVER  
5000 KG

**COVER** senza viti a vista realizzata in resina antiurto, stabilizzata ai raggi UV, inattaccabile da ruggine e corrosione. Disponibile nelle versioni quadrata o ad anello, a 2 aperture e a 3 aperture per permettere un'emissione della luce diffusa o direzionata.

**DIFFUSER** made of high impact and high-pressure load resistant resin material (PC), complete with silicone rubber gasket to ensure high protection against external agents. Frosted or coloured versions, to get a customized ambience.

**DIFFUSORE** in resina antiurto altamente resistente al carico (PC), completo di guarnizione in gomma siliconica per garantire un alto livello di protezione contro gli agenti esterni. Disponibile nella versione satinata o colorata, per ottenere un'ambientazione personalizzata.

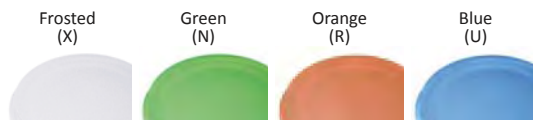

**HOUSING** made of shockproof resin material, provided with double holes and double watertight cable glands for safe connecting cable.

**CASSA** realizzata in resina antiurto, provvista di doppi fori e doppio pressacavo a tenuta stagna, per consentire in maniera sicura l'ingresso e l'uscita delle connessioni elettriche.

**INSTALLATION HOUSING** made of shockproof resin material to be fixed into the ground before installing the luminaries.

**CONTRO-CASSA** in resina antiurto da fissare al suolo prima dell'installazione degli apparecchi.

**CECI 160**



**Dimensions and weight**

Installation housing depth: 111 mm  
Diameter: Ø 160 mm  
Weight: 0,6 Kg

**Cover colours:**

Black      Grey

**Diffuser PC:**

Frosted  
Blue      Green      Orange

**GX53 LED**

\*ADD SUFFIX



	<b>7 W</b>	<b>800 Lm</b>	4000 K	.C1L
			3000 K	.C1R
	<b>10 W</b>	<b>1200 Lm</b>	4000 K	.D1L
			3000 K	.D1R

In-ground supplied as standard with TÜV approved, long-life and efficient GX53 LED lamp included. Different wattages available. Quick and easy lamp replacement for a very simple maintenance after installation.

- **COST SAVING:** long-life and efficient LED light sources
- **BUILT-IN DRIVER:** quick and easy lamp replacement
- **GREAT FLEXIBILITY:** GX53 standard lamp holder
- **FUTURE-PROOFED LUMINARIES:** performances easy to upgrade to latest technology developments
- **SUITABLE FOR OUTDOOR USE:** built-in driver fully protected against heat and humidity by silicone paste.

**7W** = **75W**  
**800 Lm**      incandescent

**SAVE 90%**



**10W** = **100W**  
**1200 Lm**      incandescent

**SAVE 90%**



**LED LAMPS**



More technical details about TÜV approved Fumagalli LED Lamps on page 468.

\*ADD THESE SUFFIXES TO THE REFERENCES MENTIONED IN THE CATALOGUE

**CECI 160**  
*IN-GROUND*

BULKHEAD  
FLOODLIGHT  
IN-GROUND  
BRICKLIGHT  
BOLLARDS  
GARDEN  
URBAN CLASSIC  
URBAN MODERN  
HIGH-BAY  
POST  
LAMPS



3F2.000.AUD1L



3F1.000.C1L



3F4.000.C1L



3F3.000.C1L

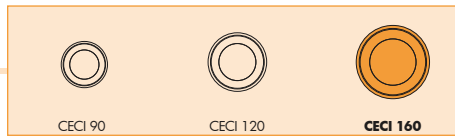

CECI 160		
3F1.000.C1L	<b>7W</b>	3F1.000.C1R
3F1.000.D1L	<b>10W</b>	3F1.000.D1R
4000K	GX53 LED LAMP INCLUDED	3000K

Pcs 18  
Kg 15  
mc 0,084

CECI 160-3L		
3F3.000.C1L	<b>7W</b>	3F3.000.C1R
3F3.000.D1L	<b>10W</b>	3F3.000.D1R
4000K	GX53 LED LAMP INCLUDED	3000K

Pcs 18  
Kg 15  
mc 0,084

CECI 160-2L		
3F2.000.C1L	<b>7W</b>	3F2.000.C1R
3F2.000.D1L	<b>10W</b>	3F2.000.D1R
4000K	GX53 LED LAMP INCLUDED	3000K

Pcs 18  
Kg 15  
mc 0,084

CECI 160-SQ		
3F4.000.C1L	<b>7W</b>	3F4.000.C1R
3F4.000.D1L	<b>10W</b>	3F4.000.D1R
4000K	GX53 LED LAMP INCLUDED	3000K

Pcs 18  
Kg 15  
mc 0,084

BULKHEAD

FLOODLIGHT

IN-GROUND

BRICKLIGHT

BOLLARDS

GARDEN

URBAN CLASSIC

URBAN MODERN

HIGH-BAY

POST

LAMPS

	LAMPS
	POST
	HIGH-BAY
	URBAN MODERN
	URBAN CLASSIC
	GARDEN
	BOLLARDS
	BRICKLIGHT
	IN-GROUND
	FLOODLIGHT
	BULKHEAD



# BRICKLIGHT

BULKHEAD

FLOODLIGHT

IN-GROUND

BOLLARDS

GARDEN

URBAN CLASSIC

URBAN MODERN

HIGH-BAY

POST

LAMPS



# LETI 100 ROUND RECESSED LAMP

Recessed wall lamp with round shape, made of shockproof resin material, UV-rays stabilized, rust and corrosion-free. Supplied as standard with TÜV approved, long-life and efficient **GX53 LED lamp 3W-350lm included**. Available in 4 different cover options to get a diffuse or downwards directed light emission. Insulation class II, Protection rating IP66.

*Lampada LED per incasso a muro con forma circolare, realizzata in resina antiurto, stabilizzata ai raggi UV, inattaccabile da ruggine e corrosione. Fornito con inclusa lampadina a LED GX53 3W-350lm approvata TÜV, di lunga durata ed elevata efficienza. Disponibile in 4 differenti versioni di cover per permettere un'emissione della luce diffusa o diretta verso il basso. Classe di isolamento II, grado di protezione IP66.*

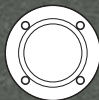

LETI 100 ROUND  
2C1.000



LETI 100 ROUND-GR  
2C2.000



LETI 100 ROUND-EL  
2C3.000



LETI 100 ROUND-ST  
2C4.000



2C1.000.G1L

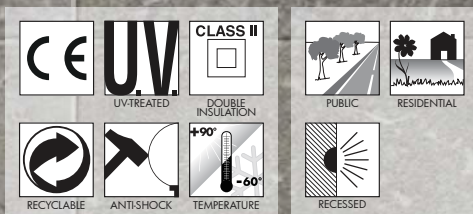

MADE IN ITALY

## LETI 100 ROUND - COMPONENTS

IP 66



**COVER** made of shockproof resin material, UV-rays stabilized, rust and corrosion free. Different shapes available allowing a diffuse or a downwards light emission.

*COVER realizzata in resina antiurto, stabilizzata ai raggi UV, inattaccabile da ruggine e corrosione. Disponibile in diverse versioni per permettere un'emissione della luce diffusa o diretta verso il basso.*

Opal **DIFFUSER** made of UV-rays stabilized polymethylmethacrylate (PMMA).

*DIFFUSORE opale realizzato in polimetilmetacrilato (PMMA) stabilizzato ai raggi UV.*

High quality silicone rubber **GASKET** to ensure high protection against external agents.

*GUARNIZIONE in gomma siliconica per garantire un alto livello di protezione contro gli agenti esterni.*

**HOUSING** made of shockproof resin material, UV rays stabilized, suitable for the electrical devices fixation. Provided with **GX53 3W led lamp** and with silicone rubber gasket to ensure high protection against external agents.

*CASSA realizzata in resina antiurto, stabilizzata ai raggi UV, adatta ad alloggiare gli accessori elettrici. Fornita completa di lampadina led 3W GX53 e guarnizione in gomma siliconica per garantire un alto livello di protezione contro gli agenti esterni.*

**INSTALLATION HOUSING** made of resin material to be cemented into the wall before installing the luminaries. Provided with double cable entry with silicone cable gland.

*CONTRO-CASSA in resina da cementare nel muro prima dell'installazione degli apparecchi. Completa di doppia entrata per il cavo elettrico e passacavo in gomma.*

## LETI 100 ROUND



### Dimensions and weight

Diameter: Ø 134 mm  
Installation housing depth: 80 mm  
Weight: 0,5 Kg

### Moulded colours:

Black     White     Grey

### Diffuser PMMA:

Opal

## GX53 LED

\*ADD SUFFIX



	3 W	350 Lm	4000 K	.G1L
			3000 K	.G1R

Recessed lamp supplied as standard with TÜV approved, long-life and efficient **GX53 LED lamp 3W-350lm included**. Quick and easy lamp replacement for a very simple maintenance after installation.

- **COST SAVING:** long-life and efficient LED light sources
- **BUILT-IN DRIVER:** quick and easy lamp replacement
- **GREAT FLEXIBILITY:** GX53 standard lamp holder
- **FUTURE-PROOFED LUMINARIES:** performances easy to upgrade to latest technology developments.



**3W 350 Lm** = **40W** incandescent  
**SAVE 93%**

## LED LAMPS



More technical details about TÜV approved Fumagalli LED Lamps on page 468.

\*ADD THESE SUFFIXES TO THE REFERENCES MENTIONED IN THE CATALOGUE

# LETI 100 ROUND RECESSED LAMP

BULKHEAD

FLOODLIGHT

IN-GROUND

BRICKLIGHT

BOLLARDS

GARDEN

URBAN CLASSIC

URBAN MODERN

HIGH-BAY

POST

LAMPS



2C3.000.G1L



2C1.000.G1L



2C4.000.G1L

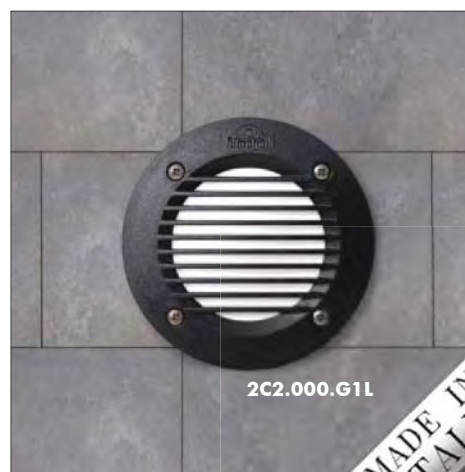

2C2.000.G1L

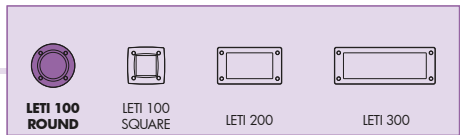

**LETI 100 ROUND**

2C1.000.G1L	<b>3W</b>	2C1.000.G1R
4000K	GX53 LED LAMP INCLUDED	3000K

Pcs 48  
Kg 24  
mc 0,12

**LETI 100 ROUND-GR**

2C2.000.G1L	<b>3W</b>	2C2.000.G1R
4000K	GX53 LED LAMP INCLUDED	3000K

Pcs 48  
Kg 24  
mc 0,12

**LETI 100 ROUND-EL**

2C3.000.G1L	<b>3W</b>	2C3.000.G1R
4000K	GX53 LED LAMP INCLUDED	3000K

Pcs 48  
Kg 24  
mc 0,12

**LETI 100 ROUND-ST**

2C4.000.G1L	<b>3W</b>	2C4.000.G1R
4000K	GX53 LED LAMP INCLUDED	3000K

Pcs 48  
Kg 24  
mc 0,12

# LETI 100 SQUARE RECESSED LAMP



Recessed wall lamp with square shape, made of shockproof resin material, UV-rays stabilized, rust and corrosion-free. Supplied as standard with TÜV approved, long-life and efficient **GX53 LED lamp 3W-350lm** included. Available in 4 different cover options to get a diffuse or downwards directed light emission. Insulation class II, Protection rating IP66.

*Lampada ad incasso a muro con forma quadra, realizzata in resina antiurto stabilizzata ai raggi UV, inattaccabile da ruggine e corrosione. Fornito con inclusa lampadina a LED GX53 3W-350lm approvata TÜV, di lunga durata ed elevata efficienza. Disponibile in 4 differenti versioni di cover per permettere un'emissione della luce diffusa o diretta verso il basso. Classe di isolamento II, grado di protezione IP66.*



LETI 100 SQUARE  
3C1.000



LETI 100 SQUARE-GR  
3C2.000



LETI 100 SQUARE-EL  
3C3.000



LETI 100 SQUARE-ST  
3C4.000



3C1.000.G1L

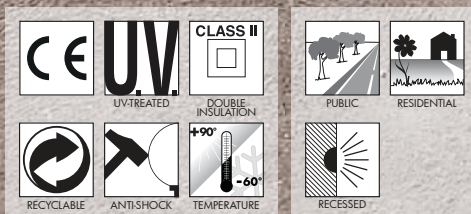

MADE IN ITALY

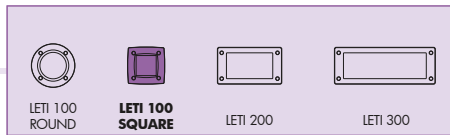

## LETI 100 SQUARE - COMPONENTS

IP 66



**COVER** made of shockproof resin material, UV-rays stabilized, rust and corrosion free. Different shapes available allowing a diffuse or a downwards light emission.

***COVER** realizzata in resina antiurto, stabilizzata ai raggi UV, inattaccabile da ruggine e corrosione. Disponibile in diverse versioni per permettere un'emissione della luce diffusa o diretta verso il basso.*

Opal **DIFFUSER** made of UV-rays stabilized polymethylmethacrylate (PMMA).

***DIFFUSORE** opale realizzato in polimetilmetacrilato (PMMA) stabilizzato ai raggi UV.*

High quality silicone rubber **GASKET** to ensure high protection against external agents.

***GUARNIZIONE** in gomma siliconica per garantire un alto livello di protezione contro gli agenti esterni.*

**HOUSING** made of shockproof resin material, UV rays stabilized, suitable for the electrical devices fixation. Provided with **GX53 3W led lamp** and with silicone rubber gasket to ensure high protection against external agents.

***CASSA** realizzata in resina antiurto, stabilizzata ai raggi UV, adatta ad alloggiare gli accessori elettrici. Fornita completa di lampadina led 3W GX53 e guarnizione in gomma siliconica per garantire un alto livello di protezione contro gli agenti esterni.*

**INSTALLATION HOUSING** made of resin material to be cemented into the wall before installing the luminaries. Provided with double cable entry with silicone cable gland.

***CONTRO-CASSA** in resina da cementare nel muro prima dell'installazione degli apparecchi. Completa di doppia entrata per il cavo elettrico e passacavo in gomma.*

## LETI 100 SQUARE



### Dimensions and weight

Height: 115 mm  
Width: 115 mm  
Installation housing depth: 80 mm  
Weight: 0,5 Kg

### Moulded colours:

Black  White  Grey

### Diffuser PMMA:

Opal

## GX53 LED

\*ADD SUFFIX



	3 W	350 Lm	4000 K	.G1L
			3000 K	.G1R

Recessed lamp supplied as standard with TÜV approved, long-life and efficient **GX53 LED lamp 3W-350lm** included. Quick and easy lamp replacement for a very simple maintenance after installation.

- **COST SAVING:** long-life and efficient LED light sources
- **BUILT-IN DRIVER:** quick and easy lamp replacement
- **GREAT FLEXIBILITY:** GX53 standard lamp holder
- **FUTURE-PROOFED LUMINARIES:** performances easy to upgrade to latest technology developments.

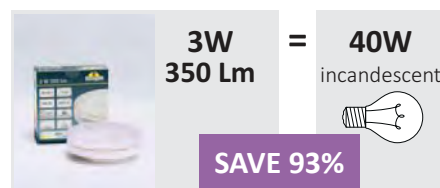

**3W 350 Lm** = **40W** incandescent  
**SAVE 93%**

## LED LAMPS



More technical details about TÜV approved Fumagalli LED Lamps on page 468.

\*ADD THESE SUFFIXES TO THE REFERENCES MENTIONED IN THE CATALOGUE

# LETI 100 SQUARE RECESSED LAMP

BULKHEAD

FLOODLIGHT

IN-GROUND

BRICKLIGHT

BOLLARDS

GARDEN

URBAN CLASSIC

URBAN MODERN

HIGH-BAY

POST

LAMPS



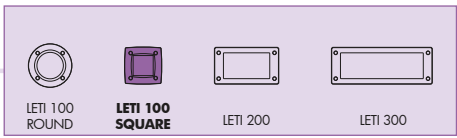

**LETI 100 SQUARE**

3C1.000.G1L	<b>3W</b>	3C1.000.G1R
4000K	GX53 LED LAMP INCLUDED	3000K

Pcs 48  
Kg 24  
mc 0,12

**LETI 100 SQUARE-GR**

3C2.000.G1L	<b>3W</b>	3C2.000.G1R
4000K	GX53 LED LAMP INCLUDED	3000K

Pcs 48  
Kg 24  
mc 0,12

**LETI 100 SQUARE-EL**

3C3.000.G1L	<b>3W</b>	3C3.000.G1R
4000K	GX53 LED LAMP INCLUDED	3000K

Pcs 48  
Kg 24  
mc 0,12

**LETI 100 SQUARE-ST**

3C4.000.G1L	<b>3W</b>	3C4.000.G1R
4000K	GX53 LED LAMP INCLUDED	3000K

Pcs 48  
Kg 24  
mc 0,12











# LETI 200 RECESSED LAMP

Recessed wall lamp with rectangular shape, made of shockproof resin material, UV-rays stabilized, rust and corrosion-free. Supplied as standard with TÜV approved, long-life and efficient **GX53 LED lamp 3W-350lm included**. Available in 5 different cover options to get a diffuse or downwards directed light emission. Insulation class II, Protection rating IP66.

*Lampada ad incasso a muro con forma rettangolare, realizzata in resina antiurto stabilizzata ai raggi UV, inattaccabile da ruggine e corrosione. Fornita con inclusa lampadina a LED GX53 3W-350lm approvata TÜV, di lunga durata ed elevata efficienza. Disponibile in 5 differenti versioni di cover per permettere un'emissione della luce diffusa o diretta verso il basso. Classe di isolamento II, grado di protezione IP66.*



4C4.000.G1L

**LETI 200 - COMPONENTS**

**IP 66**



**COVER** made of shockproof resin material, UV-rays stabilized, rust and corrosion free. Different shapes available allowing a diffuse or a downwards light emission.

***COVER** realizzata in resina antiurto, stabilizzata ai raggi UV, inattaccabile da ruggine e corrosione. Disponibile in diverse versioni per permettere un'emissione della luce diffusa o diretta verso il basso.*

Opal **DIFFUSER** made of UV-rays stabilized polymethylmethacrylate (PMMA).

***DIFFUSORE** opale realizzato in polimetilmetacrilato (PMMA) stabilizzato ai raggi UV.*

High quality silicone rubber **GASKET** to ensure high protection against external agents.

***GUARNIZIONE** in gomma siliconica per garantire un alto livello di protezione contro gli agenti esterni.*

**HOUSING** made of shockproof resin material, UV rays stabilized, suitable for the electrical devices fixation. Provided with **GX53 3W led lamp** and with silicone rubber gasket to ensure high protection against external agents.

***CASSA** realizzata in resina antiurto, stabilizzata ai raggi UV, adatta ad alloggiare gli accessori elettrici. Fornita completa di lampadina led 3W GX53 e guarnizione in gomma siliconica per garantire un alto livello di protezione contro gli agenti esterni.*

**INSTALLATION HOUSING** made of resin material to be cemented into the wall before installing the luminaries. Provided with double cable entry with silicone cable gland.

***CONTRO-CASSA** in resina da cementare nel muro prima dell'installazione degli apparecchi. Completa di doppia entrata per il cavo elettrico e passacavo in gomma.*

**LETI 200**



**Dimensions and weight**  
Height: 113 mm  
Width: 188 mm  
Installation housing depth: 98 mm  
Weight: 0,7 Kg

**Moulded colours:**

Black     White     Grey

**Diffuser PMMA:**

Opal

**GX53 LED**

\*ADD SUFFIX



	<b>3 W</b>	<b>350 Lm</b>	4000 K	.G1L
			3000 K	.G1R

Recessed lamp supplied as standard with TÜV approved, long-life and efficient **GX53 LED lamp 3W-350lm included**. Quick and easy lamp replacement for a very simple maintenance after installation.

- **COST SAVING:** long-life and efficient LED light sources
- **BUILT-IN DRIVER:** quick and easy lamp replacement
- **GREAT FLEXIBILITY:** GX53 standard lamp holder
- **FUTURE-PROOFED LUMINARIES:** performances easy to upgrade to latest technology developments.



**3W 350 Lm** = **40W** incandescent  
**SAVE 93%**

**LED LAMPS**

More technical details about TÜV approved Fumagalli LED Lamps on page 468.

\*ADD THESE SUFFIXES TO THE REFERENCES MENTIONED IN THE CATALOGUE

**LETI 200**  
RECESSED LAMP

BULKHEAD

FLOODLIGHT

IN-GROUND

BRICKLIGHT

BOLLARDS

GARDEN

URBAN CLASSIC

URBAN MODERN

HIGH-BAY

POST

LAMPS



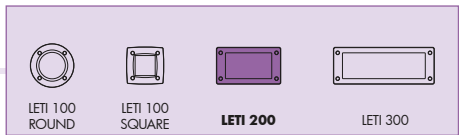

**LETI 200**

4C1.000.G1L **3W** 4C1.000.G1R

4000K GX53 LED LAMP INCLUDED 3000K

Pcs 36  
Kg 25  
mc 0,12

**LETI 200-GL**

4C2.000.G1L **3W** 4C2.000.G1R

4000K GX53 LED LAMP INCLUDED 3000K

Pcs 36  
Kg 25  
mc 0,12

**LETI 200-RS**

4C3.000.G1L **3W** 4C3.000.G1R

4000K GX53 LED LAMP INCLUDED 3000K

Pcs 36  
Kg 25  
mc 0,12

**LETI 200-HS**

4C4.000.G1L **3W** 4C4.000.G1R

4000K GX53 LED LAMP INCLUDED 3000K

Pcs 36  
Kg 25  
mc 0,12

**LETI 200-VP**

4C5.000.G1L **3W** 4C5.000.G1R

4000K GX53 LED LAMP INCLUDED 3000K

Pcs 36  
Kg 25  
mc 0,12

# LETI 300 RECESSED LAMP

Recessed wall lamp with rectangular shape, made of shockproof resin material, UV-rays stabilized, rust and corrosion-free. Supplied as standard with TÜV approved, long-life and efficient **GX53 LED lamps 2x 3W-700lm included**. Available in 5 different cover options to get a diffuse or downwards directed light emission. Insulation class II, Protection rating IP66.

*Lampada LED per incasso a muro con forma rettangolare, realizzata in resina antiurto stabilizzata ai raggi UV, inattaccabile da ruggine e corrosione. Fornita con incluse **2 lampadine a LED GX53 2x 3W-700lm** approvate TÜV, di lunga durata ed elevata efficienza. Disponibile in 5 differenti versioni di cover per permettere un'emissione della luce diffusa o diretta verso il basso. Classe di isolamento II, grado di protezione IP66.*

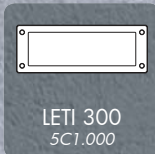

5C4.000.G2L



BULKHEAD  
FLOODLIGHT  
IN-GROUND  
BRICKLIGHT  
BOLLARDS  
GARDEN  
URBAN CLASSIC  
URBAN MODERN  
HIGH-BAY  
POST  
LAMPS

**LETI 300 - COMPONENTS**

**IP66**



**COVER** made of shockproof resin material, UV-rays stabilized, rust and corrosion free. Different shapes available allowing a diffuse or a downwards light emission.

**COVER** realizzata in resina antiurto, stabilizzata ai raggi UV, inattaccabile da ruggine e corrosione. Disponibile in diverse versioni per permettere un'emissione della luce diffusa o diretta verso il basso.

**Opal DIFFUSER** made of UV-rays stabilized polymethylmethacrylate (PMMA).

**DIFFUSORE** opale realizzato in polimetilmetacrilato (PMMA) stabilizzato ai raggi UV.

**HOUSING** made of shockproof resin material, suitable for the electrical devices fixation. Provided with **2x GX53 3W led lamps** or with E27 lampholders and with silicone rubber gasket to ensure high protection against external agents.

**CASSA** realizzata in resina antiurto, adatta ad alloggiare gli accessori elettrici. Fornita completa di **2 lampadine led 3W GX53** o di portalampada E27 e guarnizione in gomma siliconica per garantire un alto livello di protezione contro gli agenti esterni.

**INSTALLATION HOUSING** made of resin material to be cemented into the wall before installing the luminaries. Provided with double cable entry with silicone cable gland.

**CONTRO-CASSA** in resina da cementare nel muro prima dell'installazione degli apparecchi. Completa di doppia entrata per il cavo elettrico e passacavo in gomma.

**LETI 300**



**Dimensions and weight**

Height: 113 mm  
Width: 293 mm  
Installation housing depth: 98 mm  
Weight: 1 Kg

**Moulded colours:**

Black     White     Grey

**Diffuser PMMA:**

Opal

**GX53 LED**



Recessed lamp supplied complete with TÜV approved, long-life and efficient **GX53 LED lamps 2x 3W-700lm included**. Quick and easy lamp replacement for a very simple maintenance after installation.

- **COST SAVING:** long-life and efficient LED light sources
- **BUILT-IN DRIVER:** quick and easy lamp replacement
- **GREAT FLEXIBILITY:** GX53 standard lamp holder
- **FUTURE-PROOFED LUMINARIES:** performances easy to upgrade to latest technology developments.

	2x 3W <b>6W</b>	<b>700 Lm</b>	4000 K .G2L
			3000 K .G2R



**2x 3W 700 Lm** = **60W** incandescent  
**SAVE 92%**

**E27**

\*ADD SUFFIX



Recessed lamp supplied complete with E27 lampholder.

<b>E27</b> (CFL -LED)	max 160 mm ↔	.E27
--------------------------	-----------------	------

**LED LAMPS**



More technical details about TÜV approved Fumagalli LED Lamps on page 468.

\* ADD THESE SUFFIXES TO THE REFERENCES MENTIONED IN THE CATALOGUE

**LETI 300**  
RECESSED LAMP

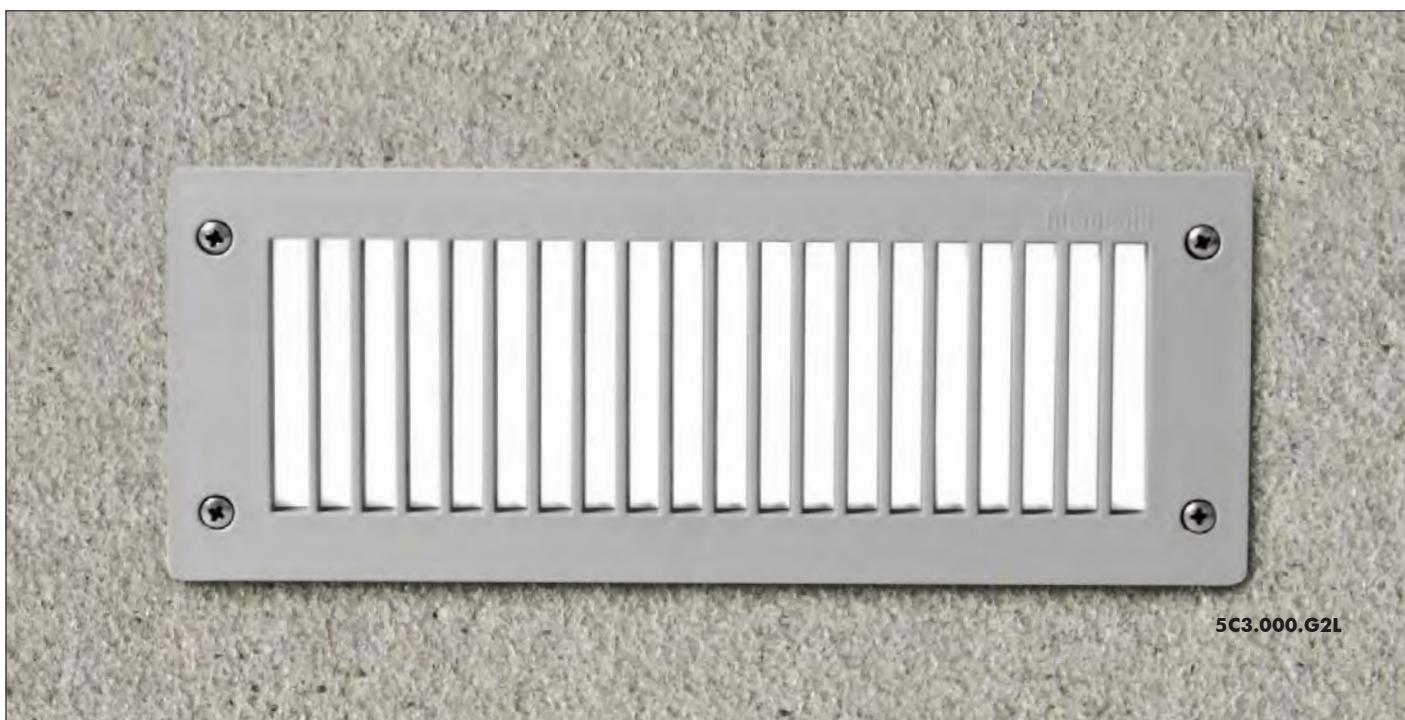

MADE IN ITALY

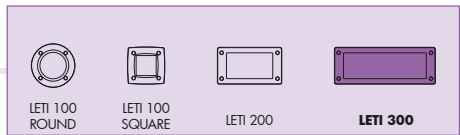

**LETI 300**

5C1.000.G2L      **6W**      5C1.000.G2R

4000K      2 GX53 LED LAMPS INCLUDED      3000K

Pcs 24  
Kg 28  
mc 0,12

**LETI 300-GL**

5C2.000.G2L      **6W**      5C2.000.G2R

4000K      2 GX53 LED LAMPS INCLUDED      3000K

Pcs 24  
Kg 28  
mc 0,12

**LETI 300-RS**

5C3.000.G2L      **6W**      5C3.000.G2R

4000K      2 GX53 LED LAMPS INCLUDED      3000K

Pcs 24  
Kg 28  
mc 0,12

**LETI 300-HS**

5C4.000.G2L      **6W**      5C4.000.G2R

4000K      2 GX53 LED LAMPS INCLUDED      3000K

Pcs 24  
Kg 28  
mc 0,12

**LETI 300-VP**

5C5.000.G2L      **6W**      5C5.000.G2R

4000K      2 GX53 LED LAMPS INCLUDED      3000K

Pcs 24  
Kg 28  
mc 0,12

BULKHEAD  
FLOODLIGHT  
IN-GROUND  
BRICKLIGHT  
BOLLARDS  
GARDEN  
URBAN CLASSIC  
URBAN MODERN  
HIGH-BAY  
POST  
LAMPS



# EXTRALETI 100 ROUND

## SURFACE LAMP

Surface wall lamp with round shape, made of shockproof resin material, UV-rays stabilized, rust and corrosion-free. Supplied as standard with TÜV approved, long-life and efficient **GX53 LED lamp 3W-350lm included**. Available in 4 different cover options to get a diffuse or downwards directed light emission. Insulation class II, Protection rating IP66.

*Lampada a muro con forma circolare, realizzata in resina antiurto, stabilizzata ai raggi UV, inattaccabile da ruggine e corrosione. Fornita con inclusa lampadina a LED GX53 3W-350lm approvata TÜV, di lunga durata ed elevata efficienza. Disponibile in 4 differenti versioni di cover per permettere un'emissione della luce diffusa o diretta verso il basso. Classe di isolamento II, grado di protezione IP66.*



EXTRALETI 100  
ROUND  
251.000



EXTRALETI 100  
ROUND-GR  
252.000



EXTRALETI 100  
ROUND-EL  
253.000



EXTRALETI 100  
ROUND-ST  
254.000



253.000.G1L

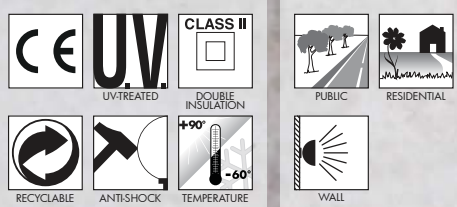

BULKHEAD  
FLOODLIGHT  
IN-GROUND  
BRICKLIGHT  
BOLLARDS  
GARDEN  
URBAN CLASSIC  
URBAN MODERN  
HIGH-BAY  
POST  
LAMPS

### EXTRALETI 100 ROUND - COMPONENTS

IP 66



**COVER** made of shockproof resin material, UV-rays stabilized, rust and corrosion free. Different shapes available allowing a diffuse or a downwards light emission.

**COVER** realizzata in resina antiurto, stabilizzata ai raggi UV, inattaccabile da ruggine e corrosione. Disponibile in diverse versioni per permettere un'emissione della luce diffusa o diretta verso il basso.

**Opal DIFFUSER** made of UV-rays stabilized polymethylmethacrylate (PMMA).

**DIFFUSORE** opale realizzato in polimetilmetacrilato (PMMA) stabilizzato ai raggi UV.

High quality silicone rubber **GASKET** to ensure high protection against external agents.

**GUARNIZIONE** in gomma siliconica per garantire un alto livello di protezione contro gli agenti esterni.

**BODY** made of shockproof resin material, UV-rays stabilized, suitable for the electrical devices fixation. Provided with **GX53 3W led lamp** and with silicone rubber gasket to ensure high protection against external agents.

**CORPO** realizzato in resina antiurto, stabilizzata ai raggi UV, adatto ad alloggiare gli accessori elettrici. Fornito completo di **lampadina led 3W GX53** e guarnizione in gomma siliconica per garantire un alto livello di protezione contro gli agenti esterni.

### EXTRALETI 100 ROUND

Ø 140



#### Dimensions and weight

Diameter: Ø 140 mm  
Depth: 64/85 mm  
Weight: 0,5 Kg

#### Moulded colours:

Black     White     Grey

#### Diffuser PMMA:

Opal

### GX53 LED

\*ADD SUFFIX



	3 W	350 Lm	4000 K	.G1L
			3000 K	.G1R

Surface lamp supplied as standard with TÜV approved, long-life and efficient **GX53 LED lamp 3W-350lm included**. Quick and easy lamp replacement for a very simple maintenance after installation.

- **COST SAVING:** long-life and efficient LED light sources
- **BUILT-IN DRIVER:** quick and easy lamp replacement
- **GREAT FLEXIBILITY:** GX53 standard lamp holder
- **FUTURE-PROOFED LUMINARIES:** performances easy to upgrade to latest technology developments.



3W 350 Lm = 40W incandescent  
**SAVE 89%**

### LED LAMPS



More technical details about TÜV approved Fumagalli LED Lamps on page 468.

\*ADD THESE SUFFIXES TO THE REFERENCES MENTIONED IN THE CATALOGUE

# EXTRALETI 100 ROUND

## SURFACE LAMP



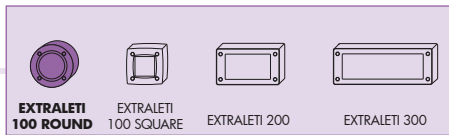

**EXTRALETI 100 ROUND**

2S1.000.G1L	<b>3W</b>	2S1.000.G1R
4000K	GX53 LED LAMP INCLUDED	3000K

Pcs 48  
Kg 24  
mc 0,12

**EXTRALETI 100 ROUND-GR**

2S2.000.G1L	<b>3W</b>	2S2.000.G1R
4000K	GX53 LED LAMP INCLUDED	3000K

Pcs 48  
Kg 24  
mc 0,12

**EXTRALETI 100 ROUND-EL**

2S3.000.G1L	<b>3W</b>	2S3.000.G1R
4000K	GX53 LED LAMP INCLUDED	3000K

Pcs 48  
Kg 24  
mc 0,12

**EXTRALETI 100 ROUND-ST**

2S4.000.G1L	<b>3W</b>	2S4.000.G1R
4000K	GX53 LED LAMP INCLUDED	3000K

Pcs 48  
Kg 24  
mc 0,12

# EXTRALETI 100 SQUARE

## SURFACE LAMP

Surface wall lamp with square shape, made of shockproof resin material, UV-rays stabilized, rust and corrosion-free. Supplied as standard with TÜV approved, long-life and efficient **GX53 LED lamp 3W-350lm included**. Available in 4 different cover options to get a diffuse or downwards directed light emission. Insulation class II, Protection rating IP66.

*Lampada a muro con forma quadra, realizzata in resina antiurto stabilizzata ai raggi UV, inattaccabile da ruggine e corrosione. Fornita con inclusa lampadina a LED GX53 3W-350lm approvata TÜV, di lunga durata ed elevata efficienza. Disponibile in 4 differenti versioni di cover per permettere un'emissione della luce diffusa o diretta verso il basso. Classe di isolamento II, grado di protezione IP66.*



EXTRALETI 100  
SQUARE  
351.000



EXTRALETI 100  
SQUARE-GR  
352.000



EXTRALETI 100  
SQUARE-EL  
353.000



EXTRALETI 100  
SQUARE-ST  
354.000



354.000.G1L

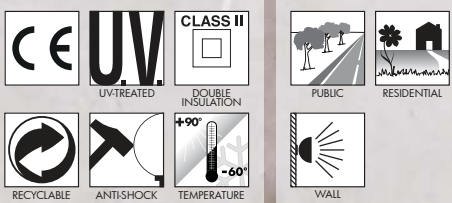

MADE IN ITALY

### EXTRALETI 100 SQUARE - COMPONENTS

IP 66



**COVER** made of shockproof resin material, UV-rays stabilized, rust and corrosion free. Different shapes available allowing a diffuse or a downwards light emission.

**COVER** realizzata in resina antiurto, stabilizzata ai raggi UV, inattaccabile da ruggine e corrosione. Disponibile in diverse versioni per permettere un'emissione della luce diffusa o diretta verso il basso.

**Opal DIFFUSER** made of UV-rays stabilized polymethylmethacrylate (PMMA).

**DIFFUSORE** opale realizzato in polimetilmetacrilato (PMMA) stabilizzato ai raggi UV.

High quality silicone rubber **GASKET** to ensure high protection against external agents.

**GUARNIZIONE** in gomma siliconica per garantire un alto livello di protezione contro gli agenti esterni.

**BODY** made of shockproof resin material, UV-rays stabilized, suitable for the electrical devices fixation. Provided with **GX53 3W led lamp** and with silicone rubber gasket to ensure high protection against external agents.

**CORPO** realizzato in resina antiurto, stabilizzata ai raggi UV, adatto ad alloggiare gli accessori elettrici. Fornito completo di **lampadina led 3W GX53** e guarnizione in gomma siliconica per garantire un alto livello di protezione contro gli agenti esterni.

### EXTRALETI 100 SQUARE

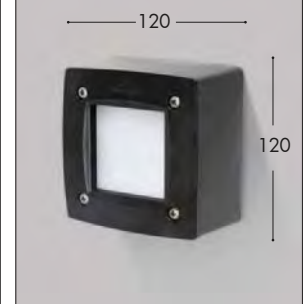

#### Dimensions and weight

Height: 120 mm  
Width: 120 mm  
Depth: 64/85 mm  
Weight: 0,5 Kg

#### Moulded colours:

Black     White     Grey

#### Diffuser PMMA:

Opal

### GX53 LED

\*ADD SUFFIX



	3 W	350 Lm	4000 K	.G1L
			3000 K	.G1R

Surface lamp supplied as standard with TÜV approved, long-life and efficient **GX53 LED lamp 3W-350lm** included. Quick and easy lamp replacement for a very simple maintenance after installation.

- **COST SAVING:** long-life and efficient LED light sources
- **BUILT-IN DRIVER:** quick and easy lamp replacement
- **GREAT FLEXIBILITY:** GX53 standard lamp holder
- **FUTURE-PROOFED LUMINARIES:** performances easy to upgrade to latest technology developments.

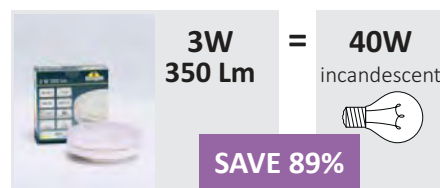

**3W 350 Lm** = **40W** incandescent  
**SAVE 89%**

### LED LAMPS

More technical details about TÜV approved Fumagalli LED Lamps on page 468.

\*ADD THESE SUFFIXES TO THE REFERENCES MENTIONED IN THE CATALOGUE

# EXTRALETI 100 SQUARE SURFACE LAMP



MADE IN  
ITALY

BULKHEAD  
FLOODLIGHT  
IN-GROUND  
BRICKLIGHT  
BOLLARDS  
GARDEN  
URBAN CLASSIC  
URBAN MODERN  
HIGH-BAY  
POST  
LAMPS

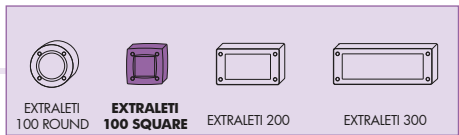

**EXTRALETI 100 SQUARE**

3S1.000.G1L	<b>3W</b>	3S1.000.G1R
4000K	GX53 LED LAMP INCLUDED	3000K

Pcs 48  
Kg 24  
mc 0,12

**EXTRALETI 100 SQUARE-GR**

3S2.000.G1L	<b>3W</b>	3S2.000.G1R
4000K	GX53 LED LAMP INCLUDED	3000K

Pcs 48  
Kg 24  
mc 0,12

**EXTRALETI 100 SQUARE-EL**

3S3.000.G1L	<b>3W</b>	3S3.000.G1R
4000K	GX53 LED LAMP INCLUDED	3000K

Pcs 48  
Kg 24  
mc 0,12

**EXTRALETI 100 SQUARE-ST**

3S4.000.G1L	<b>3W</b>	3S4.000.G1R
4000K	GX53 LED LAMP INCLUDED	3000K

Pcs 48  
Kg 24  
mc 0,12



# EXTRALETI 200

## SURFACE LAMP

BULKHEAD

FLOODLIGHT

IN-GROUND

BRICKLIGHT

BOLLARDS

GARDEN

URBAN CLASSIC

URBAN MODERN

HIGH-BAY

POST

LAMPS

Surface wall lamp with rectangular shape, made of shockproof resin material, UV-rays stabilized, rust and corrosion-free. Supplied as standard with TÜV approved, long-life and efficient **GX53 LED lamp 3W-350lm included**. Available in 5 different cover options to get a diffuse or downwards directed light emission. Insulation class II, Protection rating IP66.

*Lampada a muro con forma rettangolare, realizzata in resina antiurto stabilizzata ai raggi UV, inattaccabile da ruggine e corrosione. Fornita con inclusa lampadina a LED GX53 3W-350lm approvata TÜV, di lunga durata ed elevata efficienza. Disponibile in 5 differenti versioni di cover per permettere un'emissione della luce diffusa o diretta verso il basso. Classe di isolamento II, grado di protezione IP66.*



4S1.000.G1L

MADE IN ITALY

### EXTRALETI 200 - COMPONENTS

IP 66



**COVER** made of shockproof resin material, UV-rays stabilized, rust and corrosion free. Different shapes available allowing a diffuse or a downwards light emission.

***COVER** realizzata in resina antiurto, stabilizzata ai raggi UV, inattaccabile da ruggine e corrosione. Disponibile in diverse versioni per permettere un'emissione della luce diffusa o diretta verso il basso.*



**Opal DIFFUSER** made of UV-rays stabilized polymethylmethacrylate (PMMA).

***DIFFUSORE** opale realizzato in polimetilmetacrilato (PMMA) stabilizzato ai raggi UV.*



High quality silicone rubber **GASKET** to ensure high protection against external agents.

***GUARNIZIONE** in gomma siliconica per garantire un alto livello di protezione contro gli agenti esterni.*



**BODY** made of shockproof resin material, UV-rays stabilized, suitable for the electrical devices fixation. Provided with **GX53 3W led lamp** and with silicone rubber gasket to ensure high protection against external agents.

***CORPO** realizzato in resina antiurto, stabilizzata ai raggi UV, adatto ad alloggiare gli accessori elettrici. Fornito completo di **lampadina led 3W GX53** e guarnizione in gomma siliconica per garantire un alto livello di protezione contro gli agenti esterni.*



### EXTRALETI 200



#### Dimensions and weight

Height: 120 mm  
Width: 200 mm  
Depth: 65/85 mm  
Weight: 0,7 Kg

#### Moulded colours:

Black  White  Grey

#### Diffuser PMMA:

Opal

### GX53 LED

\*ADD. SUFFIX



	3 W	350 Lm	4000 K	.G1L
			3000 K	.G1R

Surface lamp supplied as standard with TÜV approved, long-life and efficient **GX53 LED lamp 3W-350lm included**. Quick and easy lamp replacement for a very simple maintenance after installation.

- **COST SAVING:** long-life and efficient LED light sources
- **BUILT-IN DRIVER:** quick and easy lamp replacement
- **GREAT FLEXIBILITY:** GX53 standard lamp holder
- **FUTURE-PROOFED LUMINARIES:** performances easy to upgrade to latest technology developments.



**3W 350 Lm** = **40W** incandescent

**SAVE 89%**

### LED LAMPS



More technical details about TÜV approved Fumagalli LED Lamps on page 468.

\*ADD THESE SUFFIXES TO THE REFERENCES MENTIONED IN THE CATALOGUE

**EXTRALETI 200**  
SURFACE LAMP

BULKHEAD  
FLOODLIGHT  
IN-GROUND  
BRICKLIGHT  
BOLLARDS  
GARDEN  
URBAN CLASSIC  
URBAN MODERN  
HIGH-BAY  
POST  
LAMPS



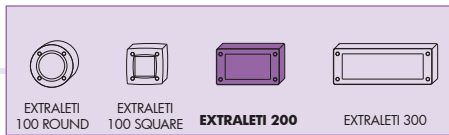

**EXTRALETI 200**

4S1.000.G1L      **3W**      4S1.000.G1R

4000K      GX53 LED LAMP INCLUDED      3000K

Pcs 36  
Kg 22  
mc 0,12

**EXTRALETI 200-GL**

4S2.000.G1L      **3W**      4S2.000.G1R

4000K      GX53 LED LAMP INCLUDED      3000K

Pcs 36  
Kg 22  
mc 0,12

**EXTRALETI 200-RS**

4S3.000.G1L      **3W**      4S3.000.G1R

4000K      GX53 LED LAMP INCLUDED      3000K

Pcs 36  
Kg 22  
mc 0,12

**EXTRALETI 200-HS**

4S4.000.G1L      **3W**      4S4.000.G1R

4000K      GX53 LED LAMP INCLUDED      3000K

Pcs 36  
Kg 22  
mc 0,12

**EXTRALETI 200-VP**

4S5.000.G1L      **3W**      4S5.000.G1R

4000K      GX53 LED LAMP INCLUDED      3000K

Pcs 36  
Kg 22  
mc 0,12

# EXTRALETI 300

## SURFACE LAMP

Surface wall lamp with rectangular shape, made of shockproof resin material, UV-rays stabilized, rust and corrosion-free. Supplied as standard with TÜV approved, long-life and efficient **GX53 LED lamps 2x 3W-700lm included**. Available in 5 different cover options to get a diffuse or downwards directed light emission. Insulation class II, Protection rating IP66.

*Lampada a muro con forma rettangolare, realizzata in resina antiurto stabilizzata ai raggi UV, inattaccabile da ruggine e corrosione. Fornita con incluse **2 lampadine a LED GX53 2x 3W-700lm** approvate TÜV, di lunga durata ed elevata efficienza. Disponibile in 5 differenti versioni di cover per permettere un'emissione della luce diffusa o diretta verso il basso. Classe di isolamento II, grado di protezione IP66.*



EXTRALETI 300  
551.000



EXTRALETI 300-GL  
552.000



EXTRALETI 300-RS  
553.000



EXTRALETI 300-VP  
555.000



EXTRALETI 300-HS  
554.000



551.000.G2L

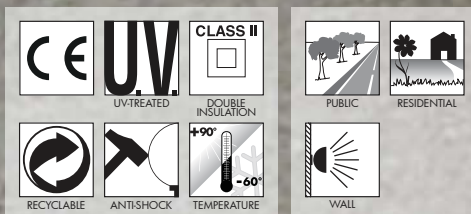

MADE IN ITALY

**EXTRALETI 300 - COMPONENTS**

IP 66



**COVER** made of shockproof resin material, UV-rays stabilized, rust and corrosion free. Different shapes available allowing a diffuse or a downwards light emission.

*COVER realizzata in resina antiurto, stabilizzata ai raggi UV, inattaccabile da ruggine e corrosione. Disponibile in diverse versioni per permettere un'emissione della luce diffusa o diretta verso il basso.*

Opal **DIFFUSER** made of UV-rays stabilized polymethylmethacrylate (PMMA).

*DIFFUSORE opale realizzato in polimetilmetacrilato (PMMA) stabilizzato ai raggi UV.*

High quality silicone rubber **GASKET** to ensure high protection against external agents.

*GUARNIZIONE in gomma siliconica per garantire un alto livello di protezione contro gli agenti esterni.*

**BODY** made of shockproof resin material, UV-rays stabilized, suitable for the electrical devices fixation. Provided with **2x GX53 3W led lamps** or with E27 lampholders and with silicone rubber gasket to ensure high protection against external agents.

*CORPO realizzato in resina antiurto, stabilizzato ai raggi UV, adatto ad alloggiare gli accessori elettrici. Fornito completo di 2 lampadine led 3W GX53 o di portalamпада E27 e guarnizione in gomma siliconica per garantire un alto livello di protezione contro gli agenti esterni.*

**EXTRALETI 300**



**Dimensions and weight**

Height: 132 mm  
Width: 313 mm  
Depth: 93/113 mm  
Weight: 1 Kg

**Moulded colours:**

Black     White     Grey

**Diffuser PMMA:**

Opal

**GX53 LED**



Surface lamp supplied complete with TÜV approved, long-life and efficient **GX53 LED lamps 2x 3W-700lm included**. Quick and easy lamp replacement for a very simple maintenance after installation.

- **COST SAVING:** long-life and efficient LED light sources
- **BUILT-IN DRIVER:** quick and easy lamp replacement
- **GREAT FLEXIBILITY:** GX53 standard lamp holder
- **FUTURE-PROOFED LUMINARIES:** performances easy to upgrade to latest technology developments.



2x 3W  
6W

700 Lm

4000 K	.G2L
3000 K	.G2R

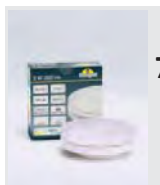

2x 3W  
700 Lm

= 60W  
incandescent

**SAVE 92%**

**E27**

\*ADD. SUFFIX



Surface lamp supplied complete with E27 lampholder.

**E27**  
(CFL-LED)

max 160 mm  
↔

.E27

**LED LAMPS**



More technical details about TÜV approved Fumagalli LED Lamps on page 468.

\* ADD THESE SUFFIXES TO THE REFERENCES MENTIONED IN THE CATALOGUE

**EXTRALETI 300**  
SURFACE LAMP

BULKHEAD  
FLOODLIGHT  
IN-GROUND  
BRICKLIGHT  
BOLLARDS  
GARDEN  
URBAN CLASSIC  
URBAN MODERN  
HIGH-BAY  
POST  
LAMPS



MADE IN ITALY

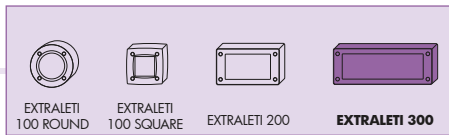

**EXTRALETI 300**

5S1.000.G2L      **6W**      5S1.000.G2R

4000K      2 GX53 LED LAMPS INCLUDED      3000K

Pcs 16  
Kg 21  
mc 0,12

**EXTRALETI 300-GL**

5S2.000.G2L      **6W**      5S2.000.G2R

4000K      2 GX53 LED LAMPS INCLUDED      3000K

Pcs 16  
Kg 21  
mc 0,12

**EXTRALETI 300-RS**

5S3.000.G2L      **6W**      5S3.000.G2R

4000K      2 GX53 LED LAMPS INCLUDED      3000K

Pcs 16  
Kg 21  
mc 0,12

**EXTRALETI 300-HS**

5S4.000.G2L      **6W**      5S4.000.G2R

4000K      2 GX53 LED LAMPS INCLUDED      3000K

Pcs 16  
Kg 21  
mc 0,12

**EXTRALETI 300-VP**

5S5.000.G2L      **6W**      5S5.000.G2R

4000K      2 GX53 LED LAMPS INCLUDED      3000K

Pcs 16  
Kg 21  
mc 0,12

BULKHEAD  
FLOODLIGHT  
IN-GROUND  
BRICKLIGHT  
BOLLARDS  
GARDEN  
URBAN CLASSIC  
URBAN MODERN  
HIGH-BAY  
POST  
LAMPS



LAMPS	
POST	
HIGH-BAY	
URBAN MODERN	
URBAN CLASSIC	
GARDEN	
BOLLARDS	
BRICKLIGHT	
IN-GROUND	
FLOODLIGHT	
BULKHEAD	



# BOLLARD

BULKHEAD

FLOODLIGHT

IN-GROUND

BRICKLIGHT

GARDEN

URBAN CLASSIC

URBAN MODERN

HIGH-BAY

POST

LAMPS

# SAURO LED

## CLASSIC BOLLARD

Bollard range in classic style made of shockproof resin material, UV-rays stabilized, rust and corrosion-free. Supplied with TÜV approved, long-life and efficient **GX53 LED lamp included** available in different wattages. Uniform light distribution for a safer and more enjoyable night atmosphere. Insulation class II, protection rating IP55.

*Gamma di bollard in stile classico, realizzata in resina antiurto, stabilizzata ai raggi UV, inattaccabile da ruggine e corrosione. Fornita con inclusa lampadina a LED GX53 approvata TÜV, di lunga durata ed elevata efficienza, disponibile in diverse potenze. Uniforme distribuzione della luce per un'atmosfera notturna sicura e gradevole. Classe di isolamento II, grado di protezione IP55.*

**D15.555.D1LCRB**



BULKHEAD  
FLOODLIGHT  
IN-GROUND  
BRICKLIGHT  
BOLLARDS  
GARDEN  
URBAN CLASSIC  
URBAN MODERN  
HIGH-BAY  
POST  
LAMPS

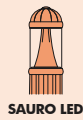

SAURO LED



SAURO E27

**SAURO LED COMPONENTS**

IP55



**CAP** made of shockproof resin material, locked to the diffuser and equipped with GX53 led lamp. To be removed for relamping by the supplied hexagonal key for locking screws.

**CALOTTA** fissata al diffusore, realizzata in resina antiurto e completa di lampadina led GX53. Rimovibile tramite vite di sicurezza per permettere il cambio della lampadina.

**DISK** made of UV-rays stabilized PMMA to spread the light and to get a lower dazzle.

**DISCO** in polimetilmetacrilato (PMMA) per diffondere la luce e ridurre l'abbagliamento.

**DIFFUSER** of UV stabilized polymethylmethacrylate (PMMA) available in clear or opal colour.

**DIFFUSORE** in polimetilmetacrilato (PMMA) resistente all'ingiallimento ed ai raggi UV, disponibile in colore trasparente o opale.

**CONE** reflector. Available in white resin (standard version) or chromed aluminium (optional).

**CONO** riflettente. Disponibile nella versione in resina bianca (standard) o in alluminio cromato (optional).

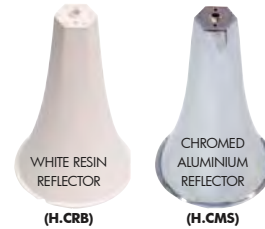

**CONNECTION RING** made of shockproof resin material, UV-rays stabilized, rust and corrosion-free.

**GHIERA** di raccordo realizzata in resina antiurto, stabilizzata ai raggi UV, inattaccabile da ruggine e corrosione.

**SAURO LED**



**Dimensions**

Height: 500/800/1100 mm

**Moulded colours:**

- Black
- White
- Grey

**Painted colours:**

- Antique green
- Antique bronze

**Diffuser PMMA:**

- Clear
- Opal

**GX53 LED**

\*ADD. SUFFIX



7 W

800 Lm

4000 K .C1L

3000 K .C1R

10 W

1200 Lm

4000 K .D1L

3000 K .D1R

Bollard supplied as standard with TÜV approved, long-life and efficient GX53 LED lamp included. Different wattages available. Quick and easy lamp replacement for a very simple maintenance after installation.

- **COST SAVING:** long-life and efficient LED light sources
- **BUILT-IN DRIVER:** quick and easy lamp replacement
- **GREAT FLEXIBILITY:** GU10 standard lamp holder
- **FUTURE-PROOFED LUMINARIES:** performances easy to upgrade to latest technology developments
- **SUITABLE FOR OUTDOOR USE:** driver fully protected against heat and humidity by silicone paste.

**LED LAMPS**



More technical details about TÜV approved Fumagalli LED Lamps on page 468.

\* ADD THESE SUFFIXES TO THE REFERENCES MENTIONED IN THE CATALOGUE

**PHOTOMETRIC DATA SAMPLE**

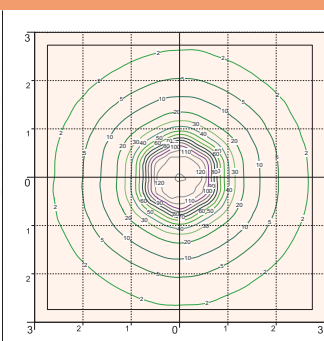
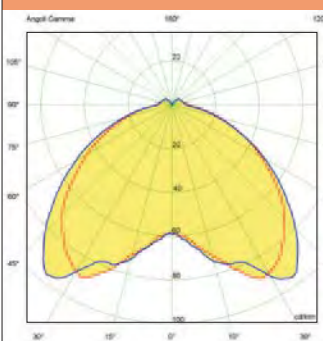

**GX53 LED 10W**  
(power consumption)

Area: 6x6mt  
Height: 1,1mt  
**23 lux**

**SAVE -88%**



**SON 70W 84W**  
(power consumption)

Area: 6x6mt  
Height: 1,1mt  
**23 lux**

**E27 VERSION**

BULKHEAD  
FLOODLIGHT  
IN-GROUND  
BRICKLIGHT  
BOLLARDS  
GARDEN  
URBAN CLASSIC  
URBAN MODERN  
HIGH-BAY  
POST  
LAMPS

**SAURO LED**  
*CLASSIC BOLLARD*

BULKHEAD  
FLOODLIGHT  
IN-GROUND  
BRICKLIGHT  
BOLLARDS  
GARDEN  
URBAN CLASSIC  
URBAN MODERN  
HIGH-BAY  
POST  
LAMPS



MADE IN  
ITALY

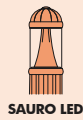

SAURO LED



SAURO E27

**SAURO 1100 LED**

D15.555.C1LCRB	<b>7W</b>	D15.555.C1RCRB
D15.555.D1LCRB	<b>10W</b>	D15.555.D1RCRB

4000K    GX53 LED LAMP INCLUDED    3000K

Pcs 1  
Kg 4,5  
mc 0,068

**SAURO 800 LED**

D15.554.C1LCRB	<b>7W</b>	D15.554.C1RCRB
D15.554.D1LCRB	<b>10W</b>	D15.554.D1RCRB

4000K    GX53 LED LAMP INCLUDED    3000K

Pcs 1  
Kg 3,6  
mc 0,05

**MIRELLA LED**

D15.505.C1LCRB	<b>7W</b>	D15.505.C1RCRB
D15.505.D1LCRB	<b>10W</b>	D15.505.D1RCRB

4000K    GX53 LED LAMP INCLUDED    3000K

Pcs 1  
Kg 2,2  
mc 0,032

**SAURO 500 LED**

D15.553.C1LCRB	<b>7W</b>	D15.553.C1RCRB
D15.553.D1LCRB	<b>10W</b>	D15.553.D1RCRB

4000K    GX53 LED LAMP INCLUDED    3000K

Pcs 1  
Kg 3,2  
mc 0,032

\*To order the aluminium chrome cone version use the CMS (instead of CRB) suffix at the end of the code

# SAURO E27











## CLASSIC BOLLARD

Bollard range in classic style made of shockproof resin material, UV-rays stabilized, rust and corrosion-free. Provided with E27 lampholder and prepared for ballast and louvre fixation. Insulation class II, protection rating IP55.

*Gamma di bollard in stile classico, realizzata in resina antiurto, stabilizzata ai raggi UV, inattaccabile da ruggine e corrosione. Fornito con portalamпада E27 e predisposto per il fissaggio dei reattori e del frangiluce. Classe di isolamento II, grado di protezione IP55.*

D15.554.FC1



MADE IN ITALY

BULKHEAD  
FLOODLIGHT  
IN-GROUND  
BRICKLIGHT  
BOLLARDS  
GARDEN  
URBAN CLASSIC  
URBAN MODERN  
HIGH-BAY  
POST  
LAMPS

**SAURO COMPONENTS**

IP55



**CAP** locked to the diffuser and made of shockproof resin material. To be removed for relamping by the supplied hexagonal key for locking screws.

**CALOTTA** fissata al diffusore e realizzata in resina antiurto. Rimovibile tramite vite di sicurezza per permettere il cambio della lampadina.

**DIFFUSER** made of UV-rays stabilized polymethylmethacrylate (PMMA), available in clear or opal colour.

**DIFFUSORE** in polimetilmetacrilato (PMMA) resistente all'ingiallimento ed ai raggi UV, disponibile in colore trasparente o opale.

**LOUVRE (Optional)** with a laminar symmetrical optic system, to direct the lighting output and to get a lower dazzle. Available in white resin material or in chrome aluminium. Recommended use with clear diffuser bollard.

**FRANGILUCE (Optional)** con sistema ottico lamellare a ripartizione simmetrica, per orientare il fascio di luce e ridurre l'abbagliamento, disponibile nella versione in resina bianca o in alluminio cromato (utilizzo raccomandato con diffusore trasparente).

CLOSED RING  
White Resin  
(H.FRA.D15)



CLOSED RING  
Aluminium Chrome  
(H.FC1)



**CONNECTION RING** provided with E27 lampholder seat in its upper side and equipped as an option with metal plate suitable for ballast fixation on its lower side.

**GHIERA** di raccordo nella cui parte superiore si trova l'alloggiamento del portalampada E27e nella cui parte inferiore possono essere fissati gli ausiliari elettrici su apposita piastra metallica (opzionale).

**SAURO**

— 150 —



**Dimensions**

Height: 500/800/1100 mm

**Moulded colours:**

- Black
- White
- Grey

**Painted colours:**

- Antique green
- Antique bronze

**Diffuser PMMA:**

- Clear
- Opal

**E27**

\*ADD. SUFFIX

Bollard supplied with E27 lampholder. Provided as an option with ballast kit for SON-HQI lamps.

**E27**  
(GLS-CFL-LED)

max 100W  
max 190 mm  
↔

.E27



**E27**  
WITH  
BALLAST

SON 70W

.S70

HQI 70W

.H70

\* ADD THESE SUFFIXES TO THE REFERENCES MENTIONED IN THE CATALOGUE

**PHOTOMETRIC DATA SAMPLE**

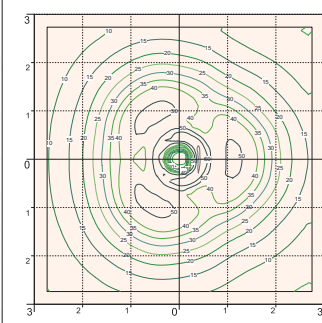
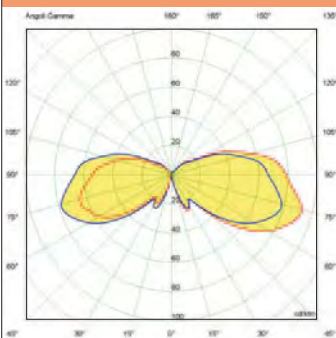

**SAURO1100** clear SON 70W.

Sauro height 1,1 mt  
Area: 6x6 mt - average 23 lux

The photometric data for all the versions are available upon request or on our website.



**SAURO E27**  
**CLASSIC BOLLARD**

BULKHEAD  
FLOODLIGHT  
IN-GROUND  
BRICKLIGHT  
BOLLARDS  
GARDEN  
URBAN CLASSIC  
URBAN MODERN  
HIGH-BAY  
POST  
LAMPS



MADE IN  
ITALY



SAURO LED

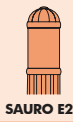

SAURO E27

**SAURO 1100**  
D15.555

Pcs 1  
Kg 4  
mc 0,068

150

1100

Ø245

**SAURO 800**  
D15.554

Pcs 1  
Kg 3,1  
mc 0,05

150

800

Ø245

**MIRELLA**  
D15.505

Pcs 1  
Kg 1,7  
mc 0,037

520

240

**SAURO 500**  
D15.553

Pcs 1  
Kg 2,7  
mc 0,032

150

500

Ø245

BULKHEAD

FLOODLIGHT

IN-GROUND

BRICKLIGHT

BOLLARDS

GARDEN

URBAN CLASSIC

URBAN MODERN

HIGH-BAY

POST

LAMPS

# CITY BOLLARDS

## CHAIN & CLASSIC BOLLARDS







Bollards with chain made of shockproof resin material, UV-rays stabilized, rust and corrosion-free. Available in different sizes.

*Bollard a catena realizzati in resina antiurto, stabilizzata ai raggi UV, inattaccabile da ruggine e corrosione. Disponibili in diverse altezze.*

BULKHEAD  
FLOODLIGHT  
IN-GROUND  
BRICKLIGHT  
BOLLARDS  
GARDEN  
URBAN CLASSIC  
URBAN MODERN  
HIGH-BAY  
POST  
LAMPS



000.515



**NARDO 900**  
000.515

Pcs 1  
Kg 1,6  
mc 0,054

CHAIN NOT INCLUDED

**NARDO 600**  
000.514

Pcs 1  
Kg 1,2  
mc 0,040

CHAIN NOT INCLUDED

**Moulded colours:**



**Painted colours:**



**BOLLARD CHAIN (OPTIONAL)**  
H.BOL.CHN

Optional resin chain for Bollard - Size 1000mm. Supplied with 2 open rings with closing system at the end.

Catena opzionale per bollard in resina - Misura 1000mm fornita con due anelli aperti con sistema di chiusura alle estremità.

LAMPS	
POST	
HIGH-BAY	
URBAN MODERN	
URBAN CLASSIC	
GARDEN	
BOLLARDS	
BRICKLIGHT	
IN-GROUND	
FLOODLIGHT	
BULKHEAD	

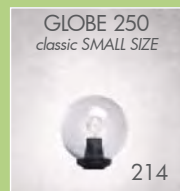

# GARDEN CLASSIC

BULKHEAD

FLOODLIGHT

IN-GROUND

BRICKLIGHT

BOLLARDS

URBAN CLASSIC

URBAN MODERN

HIGH-BAY

POST

LAMPS

# ANNA

## SMALL SIZE

E27 hexagonal lantern in classic style, made of shockproof resin material, UV-rays stabilized, rust and corrosion-free. Modular construction suitable for post top, hanging and wall installation. Supplied as optional with TÜV approved, long-life and efficient **LED filament lamps** suitable for outdoor use. Insulation class II, protection rating IP55.

*Lanterna esagonale E27 in stile classico, realizzata in resina antiurto, stabilizzata ai raggi UV, inattaccabile da ruggine e corrosione. Idonea per il montaggio a palo, a sospensione o a parete. Fornita anche completa di lampadine LED a filamento adatte ad uso in ambiente esterno, approvate TÜV, di lunga durata ed elevata efficienza. Classe di isolamento II, grado di protezione IP55.*

NEW FILAMENT LED

**INDOOR & OUTDOOR USE**

6W - 8W - 12W  
100-240 V



E22.110.F1R



BULKHEAD

FLOODLIGHT

IN-GROUND

BRICKLIGHT

BOLLARDS

GARDEN

URBAN CLASSIC

URBAN MODERN

HIGH-BAY

POST

LAMPS





**ANNA - LANTERN COMPONENTS**



**IP55**  
Decorative **PINNACLE** to be mounted on the roof top for post installation or on the lantern base for hanging installation.

**PINNACOLO** decorativo applicabile alla sommità del tetto (montaggio a palo) o sulla base della gabbia (montaggio a sospensione).

Lantern **ROOF** made of shockproof resin material, UV rays stabilized and supplied with E27 lampholder. Tool-free opening for relamping and maintenance.

**TETTO** realizzato in resina antiurto, stabilizzata ai raggi UV, fornito completo di portalampada E27. Rimovibile senza l'ausilio di attrezzi per manutenzione e cambio lampadina.

**DIFFUSER** made of UV stabilized polymethylmethacrylate (PMMA) resistant to yellowing process due to sun rays, available in clear or opal color and provided with recess for power cable supply. Made of one piece only and closed at the bottom to ensure high protection against external agents (IP 55).

**DIFFUSORE** in polimetilmetacrilato (PMMA) resistente al processo di ingiallimento dovuto ai raggi solari, disponibile in colore trasparente od opale e provvisto di scanalatura per il passaggio del cavo di alimentazione. Realizzato in un pezzo unico e con fondo chiuso per garantire un alto livello di protezione contro gli agenti esterni (IP 55).

**CAGE** made of shockproof resin material, UV-rays stabilized, rust and corrosion-free.

**GABBIA** realizzata in resina antiurto, stabilizzata ai raggi UV, inattaccabile da ruggine e corrosione.

**NEW IP55**



**ANNA**  
E22.000 \*

**Dimensions and weight**  
Height: 310 mm  
Width: 220 mm  
Depth: 192 mm  
Weight: 1 Kg

**Moulded colours:**  
Black White

**Painted colours:**  
Antique green Antique bronze

**Diffuser PMMA:**  
Clear Opal

**E27 VERSIONS** \*ADD. SUFFIX



E27 (GLS-CFL-LED)		max 60W max 160 mm	.E27
6 W	800 Lm	2700 K	.F1R
8 W	1000 Lm	2700 K	.M1R
12 W	1500 Lm	2700 K	.N1R

**NEW FILAMENT LED LAMPS**  
100-240 V

- PERFECT MATCHING WITH CLASSIC LANTERNS:** clear LED filament lamp with the look and the feeling of a traditional incandescent bulb.
- SUITABLE FOR OUTDOOR USE:** 100-240 V built-in driver fully protected against heat and humidity by silicone paste.
- OMNIDIRECTIONAL LIGHT:** 360° light output for a better lighting distribution on hexagonal and square classic lanterns.
- HIGH EFFICIENCY:** 90% energy saving.

6W 8W 12W = 60W 75W 100W incandescent

**SAVE 90%**

**LED LAMPS**

More technical details about TÜV approved Fumagalli LED Lamps on page 468.

\* ADD THESE SUFFIXES TO THE REFERENCES MENTIONED IN THE CATALOGUE

**PHOTOMETRIC DATA SAMPLE**

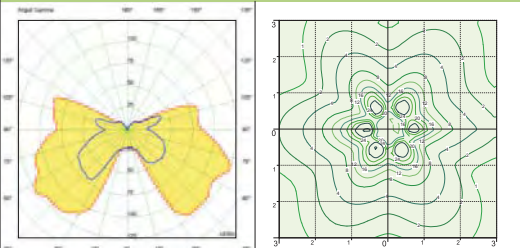

**ANNA lantern clear with Fumagalli Filament Led Lamp 6W.**

POST height 1mt  
6x6mt area: average 6 lux

The photometric data for all the versions are available upon request or on our website.

BULKHEAD  
FLOODLIGHT  
IN-GROUND  
BRICKLIGHT  
BOLLARDS  
GARDEN  
URBAN CLASSIC  
URBAN MODERN  
HIGH-BAY  
POST  
LAMPS



**ANNA**  
SMALL SIZE

BULKHEAD

FLOODLIGHT

IN-GROUND

BRICKLIGHT

BOLLARDS

GARDEN

URBAN CLASSIC

URBAN MODERN

HIGH-BAY

POST

LAMPS





BISSO/ANNA	
<b>E27</b> lamp holder	E22.131.E27
<b>6W</b> LED	E22.131.F1R
<b>8W</b> LED	E22.131.M1R
<b>12W</b> LED	E22.131.N1R
Pcs 18 Kg 20,08 mc 0,209	

SICHEM/ANNA	
<b>E27</b> lamp holder	E22.120.E27
<b>6W</b> LED	E22.120.F1R
<b>8W</b> LED	E22.120.M1R
<b>12W</b> LED	E22.120.N1R
Pcs 18 Kg 22,8 mc 0,209	

ANNA	
E22.000	
Pcs 1 Kg 1 mc 0,011	

MIKROLOT/ANNA	
<b>E27</b> lamp holder	E22.110.E27
<b>6W</b> LED	E22.110.F1R
<b>8W</b> LED	E22.110.M1R
<b>12W</b> LED	E22.110.N1R
Pcs 18 Kg 22,8 mc 0,209	

PORPORA/ANNA	
<b>E27</b> lamp holder	E22.141.E27
<b>6W</b> LED	E22.141.F1R
<b>8W</b> LED	E22.141.M1R
<b>12W</b> LED	E22.141.N1R
Pcs 1 Kg 3,5 mc 0,024	

MIZAR/ANNA resin	
<b>E27</b> lamp holder	E22.151.E27
<b>6W</b> LED	E22.151.F1R
<b>8W</b> LED	E22.151.M1R
<b>12W</b> LED	E22.151.N1R
Pcs 1 Kg 3 mc 0,044	

ALOE'R/ANNA resin	
<b>E27</b> lamp holder	E22.163.E27
<b>6W</b> LED	E22.163.F1R
<b>8W</b> LED	E22.163.M1R
<b>12W</b> LED	E22.163.N1R
Pcs 2 Kg 7,4 mc 0,121	

ARTU'/ANNA	
<b>E27</b> lamp holder	E22.158.E27
<b>6W</b> LED	E22.158.F1R
<b>8W</b> LED	E22.158.M1R
<b>12W</b> LED	E22.158.N1R
Pcs 1 Kg 9,4 mc 0,148	

BULKHEAD  
FLOODLIGHT  
IN-GROUND  
BRICKLIGHT  
BOLLARDS  
GARDEN  
URBAN CLASSIC  
URBAN MODERN  
HIGH-BAY  
POST  
LAMPS

**ANNA**  
SMALL SIZE

BULKHEAD  
FLOODLIGHT  
IN-GROUND  
BRICKLIGHT  
BOLLARDS  
GARDEN  
URBAN CLASSIC  
URBAN MODERN  
HIGH-BAY  
POST  
LAMPS





**ARTU' BISSO/ANNA 2+1**

<b>E27</b> lamp holder	E22.158.S21.E27
<b>6W</b> LED	E22.158.S21.F1R
<b>8W</b> LED	E22.158.S21.M1R
<b>12W</b> LED	E22.158.S21.N1R

Pcs 1  
Kg 12,1  
mc 0,176

**ARTU' BISSO/ANNA 3+1**

<b>E27</b> lamp holder	E22.158.S31.E27
<b>6W</b> LED	E22.158.S31.F1R
<b>8W</b> LED	E22.158.S31.M1R
<b>12W</b> LED	E22.158.S31.N1R

Pcs 1  
Kg 13,1  
mc 0,176

**GIGI BISSO/ANNA 2+1**

<b>E27</b> lamp holder	E22.156.S21.E27
<b>6W</b> LED	E22.156.S21.F1R
<b>8W</b> LED	E22.156.S21.M1R
<b>12W</b> LED	E22.156.S21.N1R

Pcs 1  
Kg 14,1  
mc 0,182

**GIGI BISSO/ANNA 3+1**

<b>E27</b> lamp holder	E22.156.S31.E27
<b>6W</b> LED	E22.156.S31.F1R
<b>8W</b> LED	E22.156.S31.M1R
<b>12W</b> LED	E22.156.S31.N1R

Pcs 1  
Kg 15,1  
mc 0,182

**ARTU' BISSO/ANNA 2L**

<b>E27</b> lamp holder	E22.158.S20.E27
<b>6W</b> LED	E22.158.S20.F1R
<b>8W</b> LED	E22.158.S20.M1R
<b>12W</b> LED	E22.158.S20.N1R

Pcs 1  
Kg 11,1  
mc 0,176

**ARTU' BISSO/ANNA 3L**

<b>E27</b> lamp holder	E22.158.S30.E27
<b>6W</b> LED	E22.158.S30.F1R
<b>8W</b> LED	E22.158.S30.M1R
<b>12W</b> LED	E22.158.S30.N1R

Pcs 1  
Kg 12,1  
mc 0,176

**GIGI BISSO/ANNA 2L**

<b>E27</b> lamp holder	E22.156.S20.E27
<b>6W</b> LED	E22.156.S20.F1R
<b>8W</b> LED	E22.156.S20.M1R
<b>12W</b> LED	E22.156.S20.N1R

Pcs 1  
Kg 13,1  
mc 0,182

**GIGI BISSO/ANNA 3L**

<b>E27</b> lamp holder	E22.156.S30.E27
<b>6W</b> LED	E22.156.S30.F1R
<b>8W</b> LED	E22.156.S30.M1R
<b>12W</b> LED	E22.156.S30.N1R

Pcs 1  
Kg 14,1  
mc 0,182

BULKHEAD  
FLOODLIGHT  
IN-GROUND  
BRICKLIGHT  
BOLLARDS  
GARDEN  
URBAN CLASSIC  
URBAN MODERN  
HIGH-BAY  
POST  
LAMPS

**SABA**  
SMALL SIZE

E27 hexagonal lantern in classic style, made of shockproof resin material, UV-rays stabilized, rust and corrosion-free. Modular construction suitable for post top, hanging and wall installation. Supplied as optional with TÜV approved, long-life and efficient **LED filament lamps** suitable for outdoor use. Insulation class II, protection rating IP55.

*Lanterna esagonale E27 in stile classico, realizzata in resina antiurto, stabilizzata ai raggi UV, inattaccabile da ruggine e corrosione. Idonea per il montaggio a palo, a sospensione o a parete. Fornita anche completa di **lampadine LED a filamento** adatte ad uso in ambiente esterno, approvate TÜV, di lunga durata ed elevata efficienza. Classe di isolamento II, grado di protezione IP55.*



**K22.131.F1R**

NEW FILAMENT LED

**INDOOR & OUTDOOR USE**

6W - 8W - 12W  
100-240 V



BULKHEAD

FLOODLIGHT

IN-GROUND

BRICKLIGHT

BOLLARDS

GARDEN

URBAN CLASSIC

URBAN MODERN

HIGH-BAY

POST

LAMPS



**SABA - LANTERN COMPONENTS**

IP55



Decorative **PINNACLE** to be mounted on the roof top for post installation or on the lantern base for hanging installation.

**PINNACOLO** decorativo applicabile alla sommità del tetto (montaggio a palo) o sulla base della gabbia (montaggio a sospensione).



Lantern **ROOF** made of shockproof resin material, UV rays stabilized and supplied with E27 lampholder. Tool-free opening for relamping and maintenance,.

**TETTO** realizzato in resina antiurto, stabilizzata ai raggi UV, fornito completo di portalamпада E27. Rimovibile senza l'ausilio di attrezzi per manutenzione e cambio lampadina.



NEW IP55

**DIFFUSER** made of UV stabilized polymethylmethacrylate (PMMA) resistant to yellowing process due to sun rays, available in clear or opal color and provided with recess for power cable supply. Made of one piece only and closed at the bottom to ensure high protection against external agents (IP 55).

**DIFFUSORE** in polimetilmetacrilato (PMMA) resistente al processo di ingiallimento dovuto ai raggi solari, disponibile in colore trasparente od opale e provvisto di scanalatura per il passaggio del cavo di alimentazione. Realizzato in un pezzo unico e con fondo chiuso per garantire un alto livello di protezione contro gli agenti esterni (IP 55).

**CAGE** made of shockproof resin material, UV-rays stabilized, rust and corrosion-free.

**GABBIA** realizzata in resina antiurto, stabilizzata ai raggi UV, inattaccabile da ruggine e corrosione.

**SABA**

K22.000 \*



220



320

Ø 60

**Dimensions and weight**

Height: 320 mm  
Width: 220 mm  
Depth: 192 mm  
Weight: 1 Kg

**Moulded colours:**

Black  White

**Painted colours:**

Antique green  Antique bronze

**Diffuser PMMA:**

Clear  Opal

**E27 VERSIONS**

\*ADD. SUFFIX



E27  
NEW FILAMENT LED LAMPS 100-240 V

E27 (GLS-CFL-LED)	max 60W max 160 mm	.E27
6 W	800 Lm	2700 K .F1R
8 W	1000 Lm	2700 K .M1R
12 W	1500 Lm	2700 K .N1R



FILAMENT LED LAMP

- **PERFECT MATCHING WITH CLASSIC LANTERNS:** clear LED filament lamp with the look and the feeling of a traditional incandescent bulb.
- **SUITABLE FOR OUTDOOR USE:** 100-240 V built-in driver fully protected against heat and humidity by silicone paste.
- **OMNIDIRECTIONAL LIGHT:** 360° light output for a better lighting distribution on hexagonal and square classic lanterns.
- **HIGH EFFICIENCY:** 90% energy saving.

6W  
8W  
12W

=

60W  
75W  
100W

incandescent

**SAVE 90%**

**LED LAMPS**

More technical details about TÜV approved Fumagalli LED Lamps on page 468.

\* ADD THESE SUFFIXES TO THE REFERENCES MENTIONED IN THE CATALOGUE

**PHOTOMETRIC DATA SAMPLE**

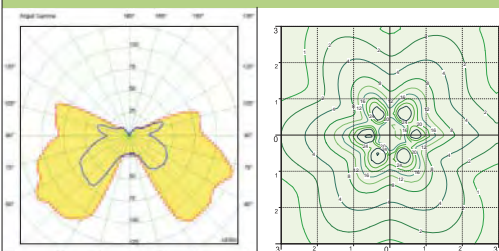

**SABA** lantern clear with Fumagalli Filament Led Lamp 6W.

POST height 1mt  
6x6mt area: average 6 lux

The photometric data for all the versions are available upon request or on our website.

**SABA**  
SMALL SIZE

BULKHEAD

FLOODLIGHT

IN-GROUND

BRICKLIGHT

BOLLARDS

GARDEN

URBAN CLASSIC

URBAN MODERN

HIGH-BAY

POST

LAMPS

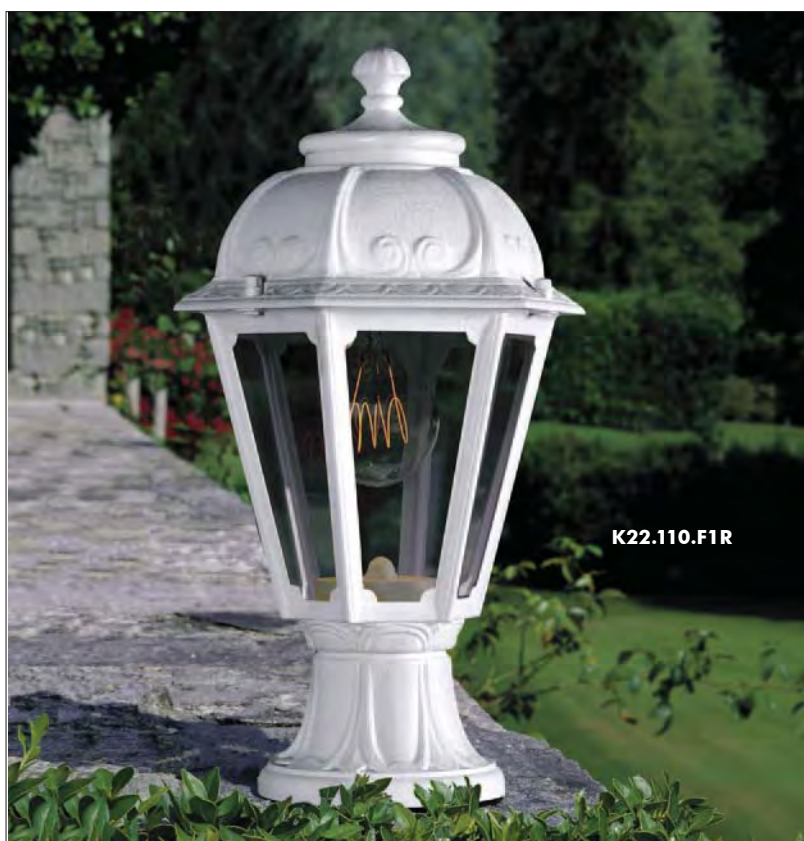



**BISSO/SABA**

<b>E27</b> lamp holder	K22.131.E27
<b>6W</b> LED	K22.131.F1R
<b>8W</b> LED	K22.131.M1R
<b>12W</b> LED	K22.131.N1R

Pcs 18  
Kg 20,08  
mc 0,209

**SICHEM/SABA**

<b>E27</b> lamp holder	K22.120.E27
<b>6W</b> LED	K22.120.F1R
<b>8W</b> LED	K22.120.M1R
<b>12W</b> LED	K22.120.N1R

Pcs 18  
Kg 22,8  
mc 0,209

**SABA**

K22.000

Pcs 1  
Kg 1  
mc 0,011

**MIKROLOT/SABA**

<b>E27</b> lamp holder	K22.110.E27
<b>6W</b> LED	K22.110.F1R
<b>8W</b> LED	K22.110.M1R
<b>12W</b> LED	K22.110.N1R

Pcs 18  
Kg 22,8  
mc 0,209

**PORPORA/SABA**

<b>E27</b> lamp holder	K22.141.E27
<b>6W</b> LED	K22.141.F1R
<b>8W</b> LED	K22.141.M1R
<b>12W</b> LED	K22.141.N1R

Pcs 1  
Kg 3,5  
mc 0,024

**MIZAR/SABA resin**

<b>E27</b> lamp holder	K22.151.E27
<b>6W</b> LED	K22.151.F1R
<b>8W</b> LED	K22.151.M1R
<b>12W</b> LED	K22.151.N1R

Pcs 1  
Kg 3  
mc 0,044

**ALOE'R/SABA resin**

<b>E27</b> lamp holder	K22.163.E27
<b>6W</b> LED	K22.163.F1R
<b>8W</b> LED	K22.163.M1R
<b>12W</b> LED	K22.163.N1R

Pcs 2  
Kg 7,4  
mc 0,121

**ARTU'/SABA**

<b>E27</b> lamp holder	K22.158.E27
<b>6W</b> LED	K22.158.F1R
<b>8W</b> LED	K22.158.M1R
<b>12W</b> LED	K22.158.N1R

Pcs 1  
Kg 9,4  
mc 0,148



**SABA**  
SMALL SIZE





SABA



SALEM



SILOE

**ARTU' BISSO/SABA 2+1**

<b>E27</b> lamp holder	K22.158.S21.E27
<b>6W</b> LED	K22.158.S21.F1R
<b>8W</b> LED	K22.158.S21.M1R
<b>12W</b> LED	K22.158.S21.N1R

Pcs 1  
Kg 12,1  
mc 0,176

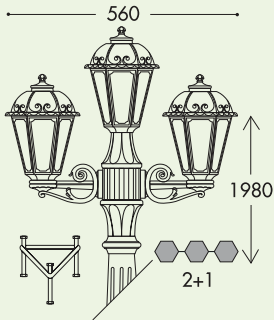

**ARTU' BISSO/SABA 3+1**

<b>E27</b> lamp holder	K22.158.S31.E27
<b>6W</b> LED	K22.158.S31.F1R
<b>8W</b> LED	K22.158.S31.M1R
<b>12W</b> LED	K22.158.S31.N1R

Pcs 1  
Kg 13,1  
mc 0,176

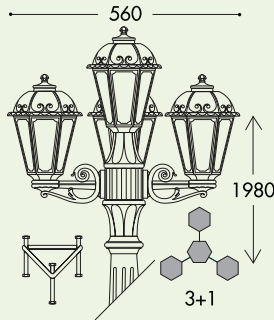

**GIGI BISSO/SABA 2+1**

<b>E27</b> lamp holder	K22.156.S21.E27
<b>6W</b> LED	K22.156.S21.F1R
<b>8W</b> LED	K22.156.S21.M1R
<b>12W</b> LED	K22.156.S21.N1R

Pcs 1  
Kg 14,1  
mc 0,182

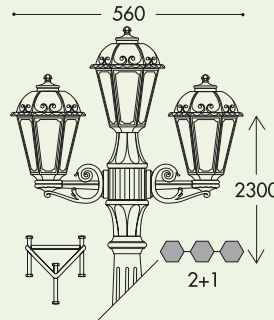

**GIGI BISSO/SABA 3+1**

<b>E27</b> lamp holder	K22.156.S31.E27
<b>6W</b> LED	K22.156.S31.F1R
<b>8W</b> LED	K22.156.S31.M1R
<b>12W</b> LED	K22.156.S31.N1R

Pcs 1  
Kg 15,1  
mc 0,182

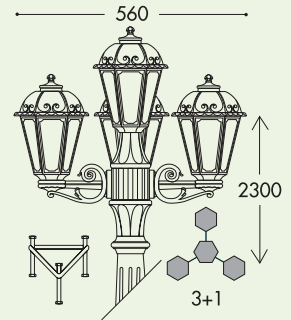

**ARTU' BISSO/SABA 2L**

<b>E27</b> lamp holder	K22.158.S20.E27
<b>6W</b> LED	K22.158.S20.F1R
<b>8W</b> LED	K22.158.S20.M1R
<b>12W</b> LED	K22.158.S20.N1R

Pcs 1  
Kg 11,1  
mc 0,176

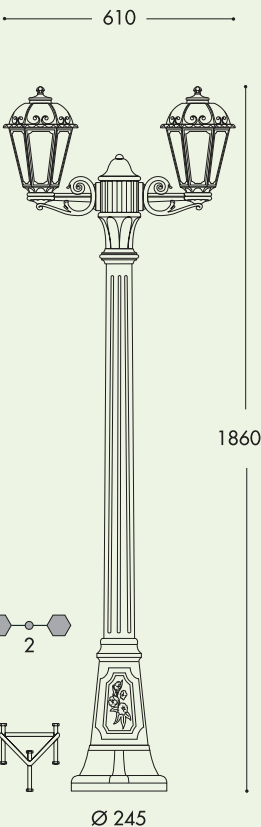

**ARTU' BISSO/SABA 3L**

<b>E27</b> lamp holder	K22.158.S30.E27
<b>6W</b> LED	K22.158.S30.F1R
<b>8W</b> LED	K22.158.S30.M1R
<b>12W</b> LED	K22.158.S30.N1R

Pcs 1  
Kg 12,1  
mc 0,176

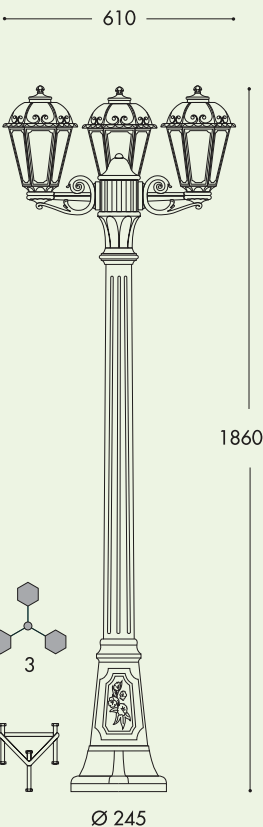

**GIGI BISSO/SABA 2L**

<b>E27</b> lamp holder	K22.156.S20.E27
<b>6W</b> LED	K22.156.S20.F1R
<b>8W</b> LED	K22.156.S20.M1R
<b>12W</b> LED	K22.156.S20.N1R

Pcs 1  
Kg 13,1  
mc 0,182

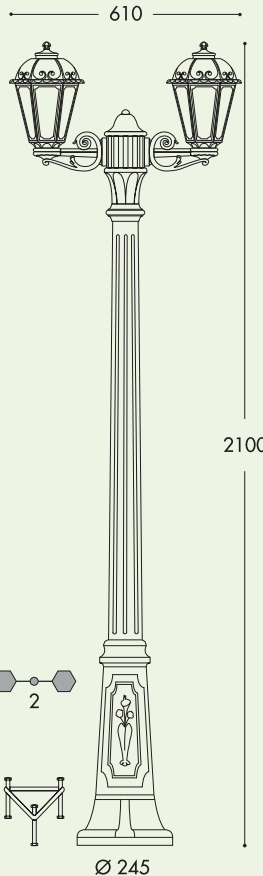

**GIGI BISSO/SABA 3L**

<b>E27</b> lamp holder	K22.156.S30.E27
<b>6W</b> LED	K22.156.S30.F1R
<b>8W</b> LED	K22.156.S30.M1R
<b>12W</b> LED	K22.156.S30.N1R

Pcs 1  
Kg 14,1  
mc 0,182

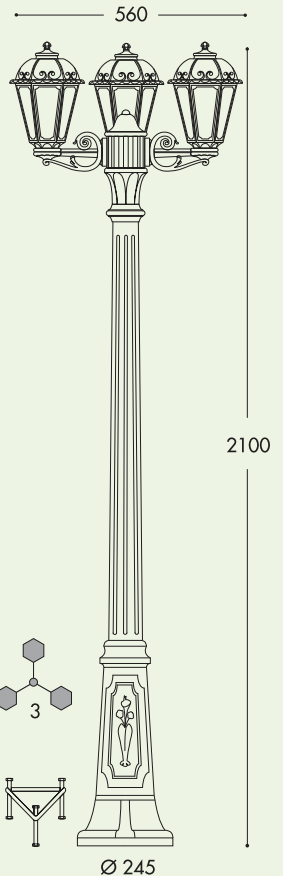

# RUT

## MEDIUM SIZE

E27 hexagonal lantern in classic style, made of shockproof resin material, UV-rays stabilized, rust and corrosion-free. Modular construction suitable for post top, hanging and wall installation. Supplied as optional with TÜV approved, long-life and efficient **LED filament lamps** suitable for outdoor use. Insulation class II, protection rating IP55.

*Lanterna esagonale E27 in stile classico, realizzata in resina antiurto, stabilizzata ai raggi UV, inattaccabile da ruggine e corrosione. Idonea per il montaggio a palo, a sospensione o a parete. Fornita anche completa di **lampadine LED a filamento** adatte ad uso in ambiente esterno, approvate TÜV, di lunga durata ed elevata efficienza. Classe di isolamento II, grado di protezione IP55.*

NEW FILAMENT LED

**INDOOR & OUTDOOR USE**

6W - 8W - 12W  
100-240 V



E26.110.M1R

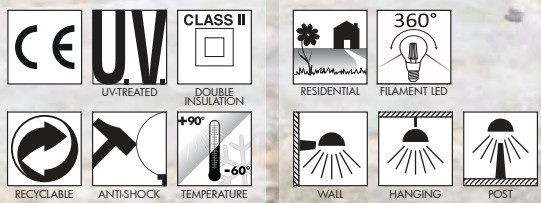



**RUT - LANTERN COMPONENTS**

**IP55**



Decorative **PINNACLE** to be mounted on the roof top for post installation or on the lantern base for hanging installation.

**PINNACOLO** decorativo applicabile alla sommità del tetto (montaggio a palo) o sulla base della gabbia (montaggio a sospensione).



Lantern **ROOF** made of shockproof resin material, UV rays stabilized and supplied with E27 lampholder. Tool-free opening for relamping and maintenance.

**TETTO** realizzato in resina antiurto, stabilizzata ai raggi UV, fornito completo di portalampada E27. Rimovibile senza l'ausilio di attrezzi per manutenzione e cambio lampadina.



**DIFFUSER** made of UV stabilized polymethylmethacrylate (PMMA) resistant to yellowing process due to sun rays, available in clear or opal color and provided with recess for power cable supply. Made of one piece only and closed at the bottom to ensure high protection against external agents (IP 55).

**DIFFUSORE** in polimetilmetacrilato (PMMA) resistente al processo di ingiallimento dovuto ai raggi solari, disponibile in colore trasparente od opale e provvisto di scanalatura per il passaggio del cavo di alimentazione. Realizzato in un pezzo unico e con fondo chiuso per garantire un alto livello di protezione contro gli agenti esterni (IP 55).

**CAGE** made of shockproof resin material, UV-rays stabilized, rust and corrosion-free.

**GABBIA** realizzata in resina antiurto, stabilizzata ai raggi UV, inattaccabile da ruggine e corrosione.

**RUT**

E26.000 \*



**Dimensions and weight**

Height: 410 mm  
Width: 260 mm  
Depth: 227 mm  
Weight: 1,26 Kg

**Moulded colours:**

Black  White

**Painted colours:**

Antique green  Antique bronze

**Diffuser PMMA:**

Clear  Opal

**E27 VERSIONS**

\*ADD. SUFFIX



E27 (GLS-CFL-LED)		max 60W max 190 mm	.E27
	6 W	800 Lm	2700 K .F1R
	8 W	1000 Lm	2700 K .M1R
	12 W	1500 Lm	2700 K .N1R

- PERFECT MATCHING WITH CLASSIC LANTERNS:** clear LED filament lamp with the look and the feeling of a traditional incandescent bulb.
- SUITABLE FOR OUTDOOR USE:** 100-240 V built-in driver fully protected against heat and humidity by silicone paste.
- OMNIDIRECTIONAL LIGHT:** 360° light output for a better lighting distribution on hexagonal and square classic lanterns.
- HIGH EFFICIENCY:** 90% energy saving.

6W  
8W  
12W = 60W  
75W  
100W incandescent

**SAVE 90%**

**LED LAMPS**

More technical details about TÜV approved Fumagalli LED Lamps on page 468.

\* ADD THESE SUFFIXES TO THE REFERENCES MENTIONED IN THE CATALOGUE

**PHOTOMETRIC DATA SAMPLE**

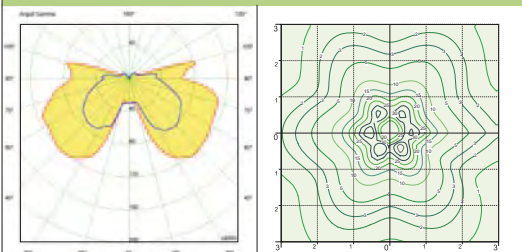

**RUT** lantern clear with Fumagalli Filament Led Lamp 6W.

POST height 2mt  
6x6mt area: average 4 lux

The photometric data for all the versions are available upon request or on our website.

**RUT**  
MEDIUM SIZE



MADE IN  
ITALY



**BISSO/RUT**

<b>E27</b> lamp holder	E26.131.E27
<b>6W</b> LED	E26.131.F1R
<b>8W</b> LED	E26.131.M1R
<b>12W</b> LED	E26.131.N1R

Pcs 18  
Kg 20,08  
mc 0,209

**SICHEM/RUT**

<b>E27</b> lamp holder	E26.120.E27
<b>6W</b> LED	E26.120.F1R
<b>8W</b> LED	E26.120.M1R
<b>12W</b> LED	E26.120.N1R

Pcs 18  
Kg 22,8  
mc 0,209

**RUT**

E26.000

Pcs 1  
Kg 1  
mc 0,011

**MIKROLOT/RUT**

<b>E27</b> lamp holder	E26.110.E27
<b>6W</b> LED	E26.110.F1R
<b>8W</b> LED	E26.110.M1R
<b>12W</b> LED	E26.110.N1R

Pcs 18  
Kg 22,8  
mc 0,209

**PORPORA/RUT**

<b>E27</b> lamp holder	E26.141.E27
<b>6W</b> LED	E26.141.F1R
<b>8W</b> LED	E26.141.M1R
<b>12W</b> LED	E26.141.N1R

Pcs 1  
Kg 3,5  
mc 0,024

**IAFET/RUT resin**

<b>E27</b> lamp holder	E26.162.E27
<b>6W</b> LED	E26.162.F1R
<b>8W</b> LED	E26.162.M1R
<b>12W</b> LED	E26.162.N1R

Pcs 2  
Kg 7,3  
mc 0,086

**MIZAR/RUT resin**

<b>E27</b> lamp holder	E26.151.E27
<b>6W</b> LED	E26.151.F1R
<b>8W</b> LED	E26.151.M1R
<b>12W</b> LED	E26.151.N1R

Pcs 1  
Kg 3  
mc 0,044

**ALOE'R/RUT resin**

<b>E27</b> lamp holder	E26.163.E27
<b>6W</b> LED	E26.163.F1R
<b>8W</b> LED	E26.163.M1R
<b>12W</b> LED	E26.163.N1R

Pcs 2  
Kg 7,4  
mc 0,121

**ARTU'/RUT**

<b>E27</b> lamp holder	E26.158.E27
<b>6W</b> LED	E26.158.F1R
<b>8W</b> LED	E26.158.M1R
<b>12W</b> LED	E26.158.N1R

Pcs 1  
Kg 9,4  
mc 0,148

**RUT**  
MEDIUM SIZE

BULKHEAD  
FLOODLIGHT  
IN-GROUND  
BRICKLIGHT  
BOLLARDS  
GARDEN  
URBAN CLASSIC  
URBAN MODERN  
HIGH-BAY  
POST  
LAMPS



MADE IN ITALY



**RICU BISSO/RUT 2+1**

<b>E27</b> lamp holder	E26.157.S21.E27
<b>6W</b> LED	E26.157.S21.F1R
<b>8W</b> LED	E26.157.S21.M1R
<b>12W</b> LED	E26.157.S21.N1R

Pcs 1  
Kg 15,2  
mc 0,214

**RICU BISSO/RUT 3+1**

<b>E27</b> lamp holder	E26.157.S31.E27
<b>6W</b> LED	E26.157.S31.F1R
<b>8W</b> LED	E26.157.S31.M1R
<b>12W</b> LED	E26.157.S31.N1R

Pcs 1  
Kg 16,2  
mc 0,214

**GIGI/RUT**

<b>E27</b> lamp holder	E26.156.E27
<b>6W</b> LED	E26.156.F1R
<b>8W</b> LED	E26.156.M1R
<b>12W</b> LED	E26.156.N1R

**E26.156**  
Pcs 1  
Kg 11,6  
mc 0,172

**RICU/RUT**

<b>E27</b> lamp holder	E26.157.E27
<b>6W</b> LED	E26.157.F1R
<b>8W</b> LED	E26.157.M1R
<b>12W</b> LED	E26.157.N1R

**E26.157**  
Pcs 1  
Kg 13  
mc 0,18

**RICU BISSO/RUT 2L**

<b>E27</b> lamp holder	E26.157.S20.E27
<b>6W</b> LED	E26.157.S20.F1R
<b>8W</b> LED	E26.157.S20.M1R
<b>12W</b> LED	E26.157.S20.N1R

Pcs 1  
Kg 14,2  
mc 0,214

**RICU BISSO/RUT 3L**

<b>E27</b> lamp holder	E26.157.S30.E27
<b>6W</b> LED	E26.157.S30.F1R
<b>8W</b> LED	E26.157.S30.M1R
<b>12W</b> LED	E26.157.S30.N1R

Pcs 1  
Kg 15,2  
mc 0,214



# SALEM

## MEDIUM SIZE



E27 hexagonal lantern in classic style, made of shockproof resin material, UV-rays stabilized, rust and corrosion-free. Modular construction suitable for post top, hanging and wall installation. Supplied as optional with TÜV approved, long-life and efficient **LED filament lamps** suitable for outdoor use. Insulation class II, protection rating IP55.

*Lanterna esagonale E27 in stile classico, realizzata in resina antiurto, stabilizzata ai raggi UV, inattaccabile da ruggine e corrosione. Idonea per il montaggio a palo, a sospensione o a parete. Fornita anche completa di **lampadine LED a filamento** adatte ad uso in ambiente esterno, approvate TÜV, di lunga durata ed elevata efficienza. Classe di isolamento II, grado di protezione IP55.*

NEW FILAMENT LED

**INDOOR & OUTDOOR USE**

6W - 8W - 12W  
100-240 V



K26.111.M1R

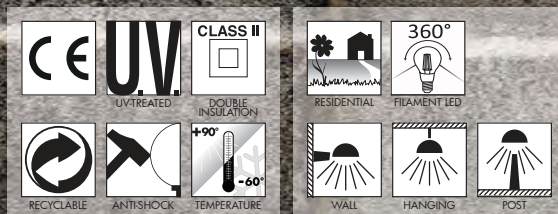

MADE IN ITALY



**SALEM - LANTERN COMPONENTS**

IP55



Decorative **PINNACLE** to be mounted on the roof top for post installation or on the lantern base for hanging installation.

**PINNACOLO** decorativo applicabile alla sommità del tetto (montaggio a palo) o sulla base della gabbia (montaggio a sospensione).

Lantern **ROOF** made of shockproof resin material, UV rays stabilized and supplied with E27 lampholder. Tool-free opening for relamping and maintenance,.

**TETTO** realizzato in resina antiurto, stabilizzata ai raggi UV, fornito completo di portalampada E27. Rimovibile senza l'ausilio di attrezzi per manutenzione e cambio lampadina.

**DIFFUSER** made of UV stabilized polymethylmethacrylate (PMMA) resistant to yellowing process due to sun rays, available in clear or opal color and provided with recess for power cable supply. Made of one piece only and closed at the bottom to ensure high protection against external agents (IP 55).

**DIFFUSORE** in polimetilmetacrilato (PMMA) resistente al processo di ingiallimento dovuto ai raggi solari, disponibile in colore trasparente od opale e provvisto di scanalatura per il passaggio del cavo di alimentazione. Realizzato in un pezzo unico e con fondo chiuso per garantire un alto livello di protezione contro gli agenti esterni (IP 55).

**CAGE** made of shockproof resin material, UV-rays stabilized, rust and corrosion-free.

**GABBIA** realizzata in resina antiurto, stabilizzata ai raggi UV, inattaccabile da ruggine e corrosione.

**SALEM**

K26.000 \*



**Dimensions and weight**

Height: 410 mm  
Width: 260 mm  
Depth: 227 mm  
Weight: 1,2 Kg

**Moulded colours:**

Black  White

**Painted colours:**

Antique green  Antique bronze

**Diffuser PMMA:**

Clear  Opal

**E27 VERSIONS**

\*ADD. SUFFIX



E27 (GLS-CFL-LED)	max 60W max 190 mm	.E27
6 W	800 Lm	2700 K .F1R
8 W	1000 Lm	2700 K .M1R
12 W	1500 Lm	2700 K .N1R

- **PERFECT MATCHING WITH CLASSIC LANTERNS:** clear LED filament lamp with the look and the feeling of a traditional incandescent bulb.
- **SUITABLE FOR OUTDOOR USE:** 100-240 V built-in driver fully protected against heat and humidity by silicone paste.
- **OMNIDIRECTIONAL LIGHT:** 360° light output for a better lighting distribution on hexagonal and square classic lanterns.
- **HIGH EFFICIENCY:** 90% energy saving.

6W  
8W  
12W = 60W  
75W  
100W incandescent

**SAVE 90%**

**LED LAMPS**

More technical details about TÜV approved Fumagalli LED Lamps on page 468.

\* ADD THESE SUFFIXES TO THE REFERENCES MENTIONED IN THE CATALOGUE

**PHOTOMETRIC DATA SAMPLE**

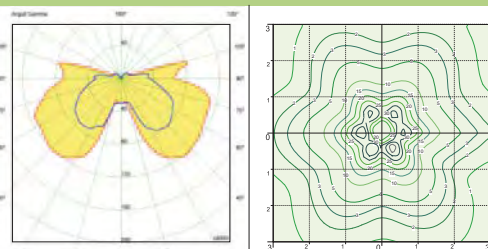

**SALEM** lantern clear with Fumagalli Filament Led Lamp 6W.

POST height 2mt  
6x6mt area: average 4 lux

The photometric data for all the versions are available upon request or on our website.

**SALEM**  
MEDIUM SIZE

BULKHEAD  
FLOODLIGHT  
IN-GROUND  
BRICKLIGHT  
BOLLARDS  
GARDEN  
URBAN CLASSIC  
URBAN MODERN  
HIGH-BAY  
POST  
LAMPS



**K26.131.M1R**



**K26.120.M1R**



**K26.151.M1R**

**MADE IN ITALY**



**BISSO/SALEM**

<b>E27</b> lamp holder	K26.131.E27
<b>6W</b> LED	K26.131.F1R
<b>8W</b> LED	K26.131.M1R
<b>12W</b> LED	K26.131.N1R

Pcs 18  
Kg 20,08  
mc 0,209

**SICHEM/SALEM**

<b>E27</b> lamp holder	K26.120.E27
<b>6W</b> LED	K26.120.F1R
<b>8W</b> LED	K26.120.M1R
<b>12W</b> LED	K26.120.N1R

Pcs 18  
Kg 22,8  
mc 0,209

**SALEM**

K26.000

Pcs 1  
Kg 1  
mc 0,011

**MIKROLOT/SALEM**

<b>E27</b> lamp holder	K26.110.E27
<b>6W</b> LED	K26.110.F1R
<b>8W</b> LED	K26.110.M1R
<b>12W</b> LED	K26.110.N1R

Pcs 18  
Kg 22,8  
mc 0,209

**PORPORA/SALEM**

<b>E27</b> lamp holder	K26.141.E27
<b>6W</b> LED	K26.141.F1R
<b>8W</b> LED	K26.141.M1R
<b>12W</b> LED	K26.141.N1R

Pcs 1  
Kg 3,5  
mc 0,024

**IAFET/SALEM resin**

<b>E27</b> lamp holder	K26.162.E27
<b>6W</b> LED	K26.162.F1R
<b>8W</b> LED	K26.162.M1R
<b>12W</b> LED	K26.162.N1R

Pcs 2  
Kg 7,3  
mc 0,086

**MIZAR/SALEM resin**

<b>E27</b> lamp holder	K26.151.E27
<b>6W</b> LED	K26.151.F1R
<b>8W</b> LED	K26.151.M1R
<b>12W</b> LED	K26.151.N1R

Pcs 1  
Kg 3  
mc 0,044

**ALOE'R/SALEM resin**

<b>E27</b> lamp holder	K26.163.E27
<b>6W</b> LED	K26.163.F1R
<b>8W</b> LED	K26.163.M1R
<b>12W</b> LED	K26.163.N1R

Pcs 2  
Kg 7,4  
mc 0,121

**ARTU'/SALEM**

<b>E27</b> lamp holder	K26.158.E27
<b>6W</b> LED	K26.158.F1R
<b>8W</b> LED	K26.158.M1R
<b>12W</b> LED	K26.158.N1R

Pcs 1  
Kg 9,4  
mc 0,148

**SALEM**  
MEDIUM SIZE

BULKHEAD

FLOODLIGHT

IN-GROUND

BRICKLIGHT

BOLLARDS

GARDEN

URBAN CLASSIC

URBAN MODERN

HIGH-BAY

POST

LAMPS



MADE IN ITALY



SABA



SALEM



SILIOE

**RICU BISSO/SALEM 2+1**

<b>E27</b> lamp holder	K26.157.S21.E27
<b>6W</b> LED	K26.157.S21.F1R
<b>8W</b> LED	K26.157.S21.M1R
<b>12W</b> LED	K26.157.S21.N1R

Pcs 1  
Kg 15,2  
mc 0,214

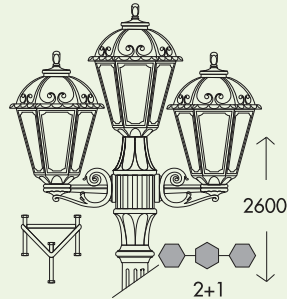

**RICU BISSO/SALEM 3+1**

<b>E27</b> lamp holder	K26.157.S31.E27
<b>6W</b> LED	K26.157.S31.F1R
<b>8W</b> LED	K26.157.S31.M1R
<b>12W</b> LED	K26.157.S31.N1R

Pcs 1  
Kg 16,2  
mc 0,214

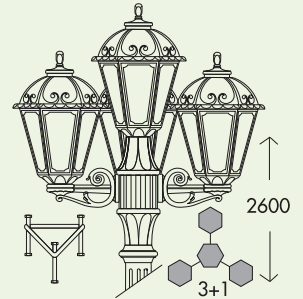

**GIGI/SALEM**

<b>E27</b> lamp holder	K26.156.E27
<b>6W</b> LED	K26.156.F1R
<b>8W</b> LED	K26.156.M1R
<b>12W</b> LED	K26.156.N1R

**K26.156**  
Pcs 1  
Kg 11,6  
mc 0,172



**RICU/SALEM**

<b>E27</b> lamp holder	K26.157.E27
<b>6W</b> LED	K26.157.F1R
<b>8W</b> LED	K26.157.M1R
<b>12W</b> LED	K26.157.N1R

**K26.157**  
Pcs 1  
Kg 13  
mc 0,18

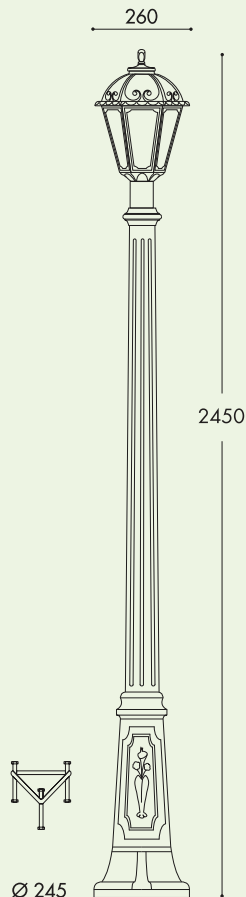

**RICU BISSO/SALEM 2L**

<b>E27</b> lamp holder	K26.157.S20.E27
<b>6W</b> LED	K26.157.S20.F1R
<b>8W</b> LED	K26.157.S20.M1R
<b>12W</b> LED	K26.157.S20.N1R

Pcs 1  
Kg 14,2  
mc 0,214

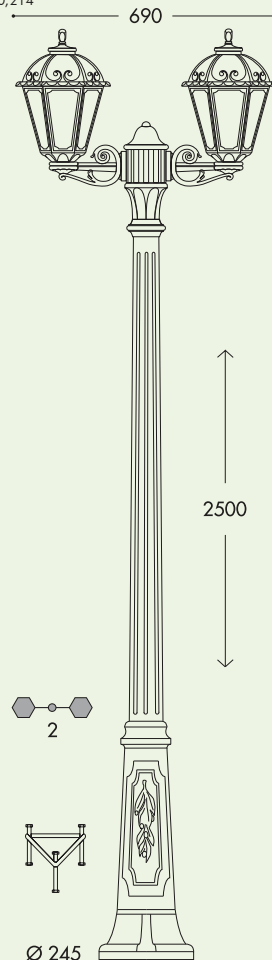

**RICU BISSO/SALEM 3L**

<b>E27</b> lamp holder	K26.157.S30.E27
<b>6W</b> LED	K26.157.S30.F1R
<b>8W</b> LED	K26.157.S30.M1R
<b>12W</b> LED	K26.157.S30.N1R

Pcs 1  
Kg 15,2  
mc 0,214

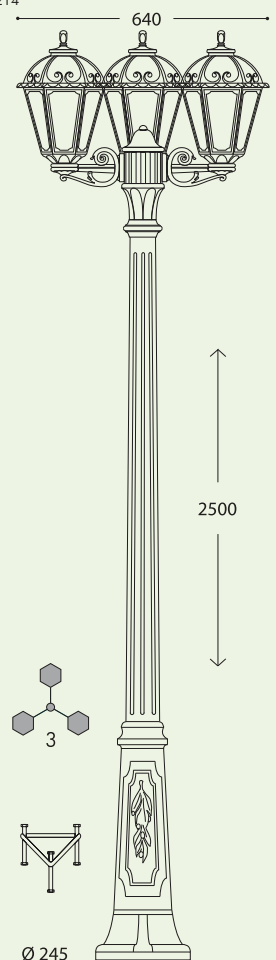

# GOLIA

## MEDIUM SIZE

BULKHEAD  
FLOODLIGHT  
IN-GROUND  
BRICKLIGHT  
BOLLARDS  
GARDEN  
URBAN CLASSIC  
URBAN MODERN  
HIGH-BAY  
POST  
LAMPS

E27 square lantern in classic style, made of shockproof resin material, UV-rays stabilized, rust and corrosion-free. Modular construction suitable for post top, hanging and wall installation. Supplied as optional with TÜV approved, long-life and efficient **LED filament lamps** suitable for outdoor use. Insulation class II, protection rating IP55.

*Lanterna quadra E27 in stile classico, realizzata in resina antiurto, stabilizzata ai raggi UV, inattaccabile da ruggine e corrosione. Idonea per il montaggio a palo, a sospensione o a parete. Fornita anche completa di lampadine LED a filamento adatte ad uso in ambiente esterno, approvate TÜV, di lunga durata ed elevata efficienza. Classe di isolamento II, grado di protezione IP55.*



NEW FILAMENT LED

INDOOR & OUTDOOR USE

6W - 8W - 12W  
100-240 V



Q23.131.M1R

MADE IN ITALY



**GOLIA - LANTERN COMPONENTS**

**IP55**



Decorative **PINNACLE** to be mounted on the roof top for post installation or on the lantern base for hanging installation.

**PINNACOLO** decorativo applicabile alla sommità del tetto (montaggio a palo) o sulla base della gabbia (montaggio a sospensione).



Lantern **ROOF** made of shockproof resin material, UV rays stabilized and supplied with E27 lampholder. Tool-free opening for relamping and maintenance.

**TETTO TETTO** realizzato in resina antiurto, stabilizzata ai raggi UV, fornito completo di portalampana E27. Rimovibile senza l'ausilio di attrezzi per manutenzione e cambio lampadina.



**DIFFUSER** made of UV stabilized polymethylmethacrylate (PMMA) resistant to yellowing process due to sun rays, available in clear or opal color and provided with recess for power cable supply. Made of one piece only and closed at the bottom to ensure high protection against external agents (IP 55).

**DIFFUSORE** in polimetilmetacrilato (PMMA) resistente al processo di ingiallimento dovuto ai raggi solari, disponibile in colore trasparente od opale e provvisto di scanalatura per il passaggio del cavo di alimentazione. Realizzato in un pezzo unico e con fondo chiuso per garantire un alto livello di protezione contro gli agenti esterni (IP 55).

**CAGE** made of shockproof resin material, UV-rays stabilized, rust and corrosion-free.

**GABBIA** realizzata in resina antiurto, stabilizzata ai raggi UV, inattaccabile da ruggine e corrosione.

**GOLIA**

Q23.000 \*



**Dimensions and weight**

Height: 360 mm  
Width: 230 mm  
Depth: 230 mm  
Weight: 1,2 Kg

**Moulded colours:**

Black  White

**Painted colours:**

Antique green  Antique bronze

**Diffuser PMMA:**

Clear  Opal

**E27 VERSIONS**

\*ADD. SUFFIX

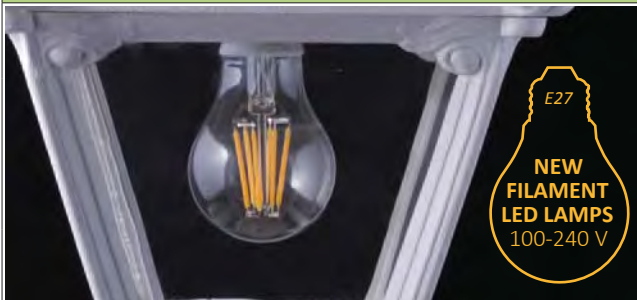

E27 (GLS-CFL-LED)		max 60W max 160 mm	.E27
	6 W	800 Lm	2700 K .F1R
	8 W	1000 Lm	2700 K .M1R
	12 W	1500 Lm	2700 K .N1R

- **PERFECT MATCHING WITH CLASSIC LANTERNS:** clear LED filament lamp with the look and the feeling of a traditional incandescent bulb.
- **SUITABLE FOR OUTDOOR USE:** 100-240 V built-in driver fully protected against heat and humidity by silicone paste.
- **OMNIDIRECTIONAL LIGHT:** 360° light output for a better lighting distribution on hexagonal and square classic lanterns.
- **HIGH EFFICIENCY:** 90% energy saving.

6W  
8W  
12W = 60W  
75W  
100W incandescent

**SAVE 90%**

**LED LAMPS**

More technical details about TÜV approved Fumagalli LED Lamps on page 468.

\* ADD THESE SUFFIXES TO THE REFERENCES MENTIONED IN THE CATALOGUE

**PHOTOMETRIC DATA SAMPLE**

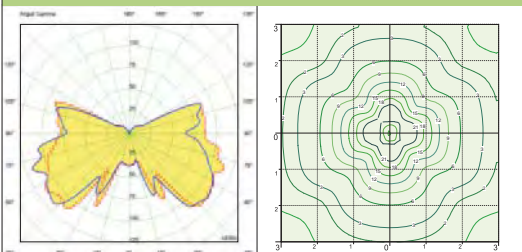

**GOLIA** lantern clear with Fumagalli Filament Led Lamp 6W.

POST height 2mt  
6x6mt area: average 4 lux

The photometric data for all the versions are available upon request or on our website.



**GOLIA**  
MEDIUM SIZE

BULKHEAD

FLOODLIGHT

IN-GROUND

BRICKLIGHT

BOLLARDS

GARDEN

URBAN CLASSIC

URBAN MODERN

HIGH-BAY

POST

LAMPS



MADE IN  
ITALY



**BISSO/GOLIA**

E27 lamp holder	Q23.131.E27
6W LED	Q23.131.F1R
8W LED	Q23.131.M1R
12W LED	Q23.131.N1R

Pcs 12  
Kg 20,8  
mc 0,225

**PORPORA/GOLIA**

E27 lamp holder	Q23.141.E27
6W LED	Q23.141.F1R
8W LED	Q23.141.M1R
12W LED	Q23.141.N1R

Pcs 1  
Kg 4  
mc 0,034

**MINILOT/GOLIA**

E27 lamp holder	Q23.111.E27
6W LED	Q23.111.F1R
8W LED	Q23.111.M1R
12W LED	Q23.111.N1R

Pcs 12  
Kg 20,8  
mc 0,225

**GOLIA**

Q23.000

Pcs 1  
Kg 1,26  
mc 0,018

**SICHEM/GOLIA**

E27 lamp holder	Q23.120.E27
6W LED	Q23.120.F1R
8W LED	Q23.120.M1R
12W LED	Q23.120.N1R

Pcs 12  
Kg 20,8  
mc 0,225

**MIZAR/GOLIA resin**

E27 lamp holder	Q23.151.E27
6W LED	Q23.151.F1R
8W LED	Q23.151.M1R
12W LED	Q23.151.N1R

Pcs 1  
Kg 3,5  
mc 0,07

**IAFET/GOLIA resin**

E27 lamp holder	Q23.162.E27
6W LED	Q23.162.F1R
8W LED	Q23.162.M1R
12W LED	Q23.162.N1R

Pcs 2  
Kg 7,3  
mc 0,086

**ALOE'.R/GOLIA resin**

E27 lamp holder	Q23.163.E27
6W LED	Q23.163.F1R
8W LED	Q23.163.M1R
12W LED	Q23.163.N1R

Pcs 2  
Kg 7,4  
mc 0,121

**ARTU'/GOLIA**

E27 lamp holder	Q23.158.E27
6W LED	Q23.158.F1R
8W LED	Q23.158.M1R
12W LED	Q23.158.N1R

Pcs 1  
Kg 9,6  
mc 0,148

**GIGI/GOLIA**

E27 lamp holder	Q23.156.E27
6W LED	Q23.156.F1R
8W LED	Q23.156.M1R
12W LED	Q23.156.N1R

Pcs 1  
Kg 11,6  
mc 0,172

**RICU/GOLIA**

E27 lamp holder	Q23.157.E27
6W LED	Q23.157.F1R
8W LED	Q23.157.M1R
12W LED	Q23.157.N1R

Pcs 1  
Kg 13  
mc 0,18

BULKHEAD  
FLOODLIGHT  
IN-GROUND  
BRICKLIGHT  
BOLLARDS  
GARDEN  
URBAN CLASSIC  
URBAN MODERN  
HIGH-BAY  
POST  
LAMPS

**GOLIA**  
MEDIUM SIZE

BULKHEAD

FLOODLIGHT

IN-GROUND

BRICKLIGHT

BOLLARDS

GARDEN

URBAN CLASSIC

URBAN MODERN

HIGH-BAY

POST

LAMPS



Q23.157.S30.M1R



Q23.156.S20.M1R



Q23.151.M1R



MADE IN ITALY



**GIGI BISSO/GOLIA 2L**

<b>E27</b> lamp holder	Q23.156.S20.E27
<b>6W</b> LED	Q23.156.S20.F1R
<b>8W</b> LED	Q23.156.S20.M1R
<b>12W</b> LED	Q23.156.S20.N1R

Pcs 1  
Kg 13,5  
mc 0,182

**GIGI BISSO/GOLIA 3L**

<b>E27</b> lamp holder	Q23.156.S30.E27
<b>6W</b> LED	Q23.156.S30.F1R
<b>8W</b> LED	Q23.156.S30.M1R
<b>12W</b> LED	Q23.156.S30.N1R

Pcs 1  
Kg 14,7  
mc 0,182

**GIGI BISSO/GOLIA 2+1**

<b>E27</b> lamp holder	Q23.156.S21.E27
<b>6W</b> LED	Q23.156.S21.F1R
<b>8W</b> LED	Q23.156.S21.M1R
<b>12W</b> LED	Q23.156.S21.N1R

Pcs 1  
Kg 14,7  
mc 0,182

**GIGI BISSO/GOLIA 3+1**

<b>E27</b> lamp holder	Q23.156.S31.E27
<b>6W</b> LED	Q23.156.S31.F1R
<b>8W</b> LED	Q23.156.S31.M1R
<b>12W</b> LED	Q23.156.S31.N1R

Pcs 1  
Kg 15,9  
mc 0,182

**RICU BISSO/GOLIA 2L**

<b>E27</b> lamp holder	Q23.157.S20.E27
<b>6W</b> LED	Q23.157.S20.F1R
<b>8W</b> LED	Q23.157.S20.M1R
<b>12W</b> LED	Q23.157.S20.N1R

Pcs 1  
Kg 14,2  
mc 0,214

**RICU BISSO/GOLIA 3L**

<b>E27</b> lamp holder	Q23.157.S30.E27
<b>6W</b> LED	Q23.157.S30.F1R
<b>8W</b> LED	Q23.157.S30.M1R
<b>12W</b> LED	Q23.157.S30.N1R

Pcs 1  
Kg 15,2  
mc 0,214

**RICU BISSO/GOLIA 2+1**

<b>E27</b> lamp holder	Q23.157.S21.E27
<b>6W</b> LED	Q23.157.S21.F1R
<b>8W</b> LED	Q23.157.S21.M1R
<b>12W</b> LED	Q23.157.S21.N1R

Pcs 1  
Kg 15,2  
mc 0,214

**RICU BISSO/GOLIA 3+1**

<b>E27</b> lamp holder	Q23.157.S31.E27
<b>6W</b> LED	Q23.157.S31.F1R
<b>8W</b> LED	Q23.157.S31.M1R
<b>12W</b> LED	Q23.157.S31.N1R

Pcs 1  
Kg 16,2  
mc 0,214

**CEFA**

**MEDIUM SIZE**

**fumagalli®**  
since 1973

E27 square lantern in classic style, made of shockproof resin material, UV-rays stabilized, rust and corrosion-free. Modular construction suitable for post top, hanging and wall installation. Supplied as optional with TÜV approved, long-life and efficient **LED filament lamps** suitable for outdoor use. Insulation class II, protection rating IP55.

*Lanterna quadra E27 in stile classico, realizzata in resina antiurto, stabilizzata ai raggi UV, inattaccabile da ruggine e corrosione. Idonea per il montaggio a palo, a sospensione o a parete. Fornita anche completa di lampadine LED a filamento adatte ad uso in ambiente esterno, approvate TÜV, di lunga durata ed elevata efficienza. Classe di isolamento II, grado di protezione IP55.*

NEW FILAMENT LED

**INDOOR &  
OUTDOOR  
USE**

6W - 8W - 12W  
100-240 V



**U23.111.M1R**

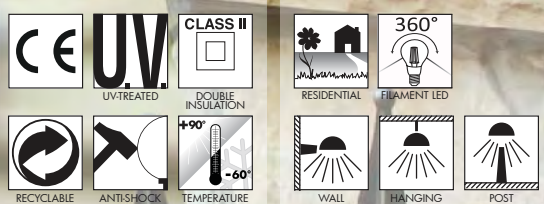



**CEFA - LANTERN COMPONENTS**

**IP55**



Decorative **PINNACLE** to be mounted on the roof top for post installation or on the lantern base for hanging installation.

**PINNACOLO** decorativo applicabile alla sommità del tetto (montaggio a palo) o sulla base della gabbia (montaggio a sospensione).

Lantern **ROOF** made of shockproof resin material, UV rays stabilized and supplied with E27 lampholder. Tool-free opening for relamping and maintenance,.

**TETTO** realizzato in resina antiurto, stabilizzata ai raggi UV, fornito completo di portalampada E27. Rimovibile senza l'ausilio di attrezzi per manutenzione e cambio lampadina.

**DIFFUSER** made of UV stabilized polymethylmethacrylate (PMMA) resistant to yellowing process due to sun rays, available in clear or opal color and provided with recess for power cable supply. Made of one piece only and closed at the bottom to ensure high protection against external agents (IP 55).

**DIFFUSORE** in polimetilmetacrilato (PMMA) resistente al processo di ingiallimento dovuto ai raggi solari, disponibile in colore trasparente od opale e provvisto di scanalatura per il passaggio del cavo di alimentazione. Realizzato in un pezzo unico e con fondo chiuso per garantire un alto livello di protezione contro gli agenti esterni (IP 55).

**CAGE** made of shockproof resin material, UV-rays stabilized, rust and corrosion-free.

**GABBIA** realizzata in resina antiurto, stabilizzata ai raggi UV, inattaccabile da ruggine e corrosione.

**CEFA**

U23.000 \*



**Dimensions and weight**

Height: 380 mm  
Width: 230 mm  
Depth: 230 mm  
Weight: 1,2 Kg

**Moulded colours:**

Black  White

**Painted colours:**

Antique green  Antique bronze

**Diffuser PMMA:**

Clear  Opal

**E27 VERSIONS**

\*ADD. SUFFIX



E27 (GLS-CFL-LED)		max 60W max 160 mm	.E27
	6 W	800 Lm	2700 K .F1R
	8 W	1000 Lm	2700 K .M1R
	12 W	1500 Lm	2700 K .N1R

- **PERFECT MATCHING WITH CLASSIC LANTERNS:** clear LED filament lamp with the look and the feeling of a traditional incandescent bulb.
- **SUITABLE FOR OUTDOOR USE:** 100-240 V built-in driver fully protected against heat and humidity by silicone paste.
- **OMNIDIRECTIONAL LIGHT:** 360° light output for a better lighting distribution on hexagonal and square classic lanterns.
- **HIGH EFFICIENCY:** 90% energy saving.

6W  
8W  
12W = 60W  
75W  
100W incandescent

**SAVE 90%**

**LED LAMPS**

More technical details about TÜV approved Fumagalli LED Lamps on page 468.



\* ADD THESE SUFFIXES TO THE REFERENCES MENTIONED IN THE CATALOGUE

**PHOTOMETRIC DATA SAMPLE**

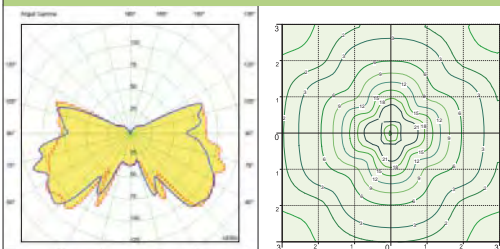

**GOLIA** lantern clear with Fumagalli Filament Led Lamp 6W.

POST height 2mt  
6x6mt area: average 4 lux

The photometric data for all the versions are available upon request or on our website.

BULKHEAD  
FLOODLIGHT  
IN-GROUND  
BRICKLIGHT  
BOLLARDS  
GARDEN  
URBAN CLASSIC  
URBAN MODERN  
HIGH-BAY  
POST  
LAMPS



**U23.131.M1R**



**U23.163.M1R**



**U23.120.M1R**

MADE IN  
ITALY



**BISSO/CEFA**

E27 lamp holder	U23.131.E27
6W LED	U23.131.F1R
8W LED	U23.131.M1R
12W LED	U23.131.N1R

Pcs 12  
Kg 20,8  
mc 0,225

**PORPORA/CEFA**

E27 lamp holder	U23.141.E27
6W LED	U23.141.F1R
8W LED	U23.141.M1R
12W LED	U23.141.N1R

Pcs 1  
Kg 4  
mc 0,034

**MINILOT/CEFA**

E27 lamp holder	U23.111.E27
6W LED	U23.111.F1R
8W LED	U23.111.M1R
12W LED	U23.111.N1R

Pcs 12  
Kg 20,8  
mc 0,225

**CEFA**

E27 lamp holder	U23.000
-----------------	---------

Pcs 1  
Kg 1,26  
mc 0,018

**SICHEM/CEFA**

E27 lamp holder	U23.120.E27
6W LED	U23.120.F1R
8W LED	U23.120.M1R
12W LED	U23.120.N1R

Pcs 12  
Kg 20,8  
mc 0,225

**MIZAR/CEFA resin**

E27 lamp holder	U23.151.E27
6W LED	U23.151.F1R
8W LED	U23.151.M1R
12W LED	U23.151.N1R

Pcs 1  
Kg 3,5  
mc 0,07

**IAFET/CEFA resin**

E27 lamp holder	U23.162.E27
6W LED	U23.162.F1R
8W LED	U23.162.M1R
12W LED	U23.162.N1R

Pcs 2  
Kg 7,3  
mc 0,086

**ALOE'R/CEFA resin**

E27 lamp holder	U23.163.E27
6W LED	U23.163.F1R
8W LED	U23.163.M1R
12W LED	U23.163.N1R

Pcs 2  
Kg 7,4  
mc 0,121

**ARTU'/CEFA**

E27 lamp holder	U23.158.E27
6W LED	U23.158.F1R
8W LED	U23.158.M1R
12W LED	U23.158.N1R

Pcs 1  
Kg 9,6  
mc 0,148

**GIGI/CEFA**

E27 lamp holder	U23.156.E27
6W LED	U23.156.F1R
8W LED	U23.156.M1R
12W LED	U23.156.N1R

Pcs 1  
Kg 11,6  
mc 0,172

**RICU/CEFA**

E27 lamp holder	U23.157.E27
6W LED	U23.157.F1R
8W LED	U23.157.M1R
12W LED	U23.157.N1R

Pcs 1  
Kg 13  
mc 0,18

BULKHEAD  
FLOODLIGHT  
IN-GROUND  
BRICKLIGHT  
BOLLARDS  
GARDEN  
URBAN CLASSIC  
URBAN MODERN  
HIGH-BAY  
POST  
LAMPS



**CEFA**  
MEDIUM SIZE



MADE IN ITALY



**GIGI BISSO/CEFA 2L**

<b>E27</b> lamp holder	U23.156.S20.E27
<b>6W</b> LED	U23.156.S20.F1R
<b>8W</b> LED	U23.156.S20.M1R
<b>12W</b> LED	U23.156.S20.N1R

Pcs 1  
Kg 13,5  
mc 0,182

**GIGI BISSO/CEFA 3L**

<b>E27</b> lamp holder	U23.156.S30.E27
<b>6W</b> LED	U23.156.S30.F1R
<b>8W</b> LED	U23.156.S30.M1R
<b>12W</b> LED	U23.156.S30.N1R

Pcs 1  
Kg 14,7  
mc 0,182

**GIGI BISSO/CEFA 2+1**

<b>E27</b> lamp holder	U23.156.S21.E27
<b>6W</b> LED	U23.156.S21.F1R
<b>8W</b> LED	U23.156.S21.M1R
<b>12W</b> LED	U23.156.S21.N1R

Pcs 1  
Kg 14,7  
mc 0,182

**GIGI BISSO/CEFA 3+1**

<b>E27</b> lamp holder	U23.156.S31.E27
<b>6W</b> LED	U23.156.S31.F1R
<b>8W</b> LED	U23.156.S31.M1R
<b>12W</b> LED	U23.156.S31.N1R

Pcs 1  
Kg 15,9  
mc 0,182

**RICU BISSO/CEFA 2L**

<b>E27</b> lamp holder	U23.157.S20.E27
<b>6W</b> LED	U23.157.S20.F1R
<b>8W</b> LED	U23.157.S20.M1R
<b>12W</b> LED	U23.157.S20.N1R

Pcs 1  
Kg 14,2  
mc 0,214

**RICU BISSO/CEFA 3L**

<b>E27</b> lamp holder	U23.157.S30.E27
<b>6W</b> LED	U23.157.S30.F1R
<b>8W</b> LED	U23.157.S30.M1R
<b>12W</b> LED	U23.157.S30.N1R

Pcs 1  
Kg 15,2  
mc 0,214

**RICU BISSO/CEFA 2+1**

<b>E27</b> lamp holder	U23.157.S21.E27
<b>6W</b> LED	U23.157.S21.F1R
<b>8W</b> LED	U23.157.S21.M1R
<b>12W</b> LED	U23.157.S21.N1R

Pcs 1  
Kg 15,2  
mc 0,214

**RICU BISSO/CEFA 3+1**

<b>E27</b> lamp holder	U23.157.S31.E27
<b>6W</b> LED	U23.157.S31.F1R
<b>8W</b> LED	U23.157.S31.M1R
<b>12W</b> LED	U23.157.S31.N1R

Pcs 1  
Kg 16,2  
mc 0,214

**IESSE**  
SMALL SIZE

Half lantern in classic style with E27 lampholder, made of shockproof resin material, UV-rays stabilized, rust and corrosion-free. Supplied as optional with TÜV approved, long-life and efficient **LED filament lamps** suitable for outdoor use. Insulation class II, protection rating IP 55.

*Mezza lanterna in stile classico con portalampada E27, realizzata in resina antiurto, stabilizzata ai raggi UV, inattaccabile da ruggine e corrosione. Fornita anche completa di lampadine LED a filamento adatte ad uso in ambiente esterno, approvate TÜV, di lunga durata ed elevata efficienza. Classe di isolamento II, grado di protezione IP55.*

NEW FILAMENT LED

**INDOOR & OUTDOOR USE**

6W - 8W - 12W  
100-240 V



**M22.000.F1R**

- BULKHEAD
- FLOODLIGHT
- IN-GROUND
- BRICKLIGHT
- BOLLARDS
- GARDEN
- URBAN CLASSIC
- URBAN MODERN
- HIGH-BAY
- POST
- LAMPS





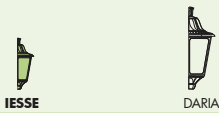

**IESSE - LANTERN COMPONENTS**

**IP55**



**CAGE** made of shockproof resin material, UV rays stabilized, rust and corrosion-free.

**GABBIA** realizzata in resina antiurto, stabilizzata ai raggi UV, inattaccabile da ruggine e corrosione.



**DIFFUSER** made of UV stabilized polymethylmethacrylate (PMMA) resistant to yellowing process due to sun rays, available in clear or opal color and made of one piece only.

**DIFFUSORE** in polimetilmetacrilato (PMMA) resistente al processo di ingiallimento dovuto ai raggi solari, disponibile in colore trasparente od opale e realizzato in un pezzo unico.



High temperature resistant **WALL PLATE** made of white polycarbonate (PC), with support for lampholder fixation. Supplied complete with E27 lampholder.

**BASE A MURO** realizzata in policarbonato (PC) bianco ad alta resistenza al calore, con supporto per il fissaggio del portalamпада. Fornita completa di portalamпада E27

**IESSE**

<b>E27</b>	M22.000.E27
<b>6W LED</b>	M22.000.F1R
<b>8W LED</b>	M22.000.M1R
<b>12W LED</b>	M22.000.N1R

Pcs 16  
Kg 18  
mc 0,224

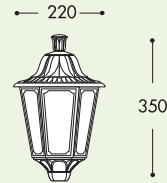

130

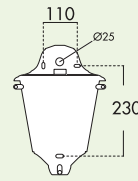

**IESSE**

M22.000 \*



**Dimensions and weight**

Height: 350 mm  
Width: 220 mm  
Depth: 130 mm  
Weight: 1,2 Kg

**Moulded colours:**

Black White

**Painted colours:**

Antique green Antique bronze

**Diffuser PMMA:**

Clear Opal

**E27 VERSIONS**

\*ADD. SUFFIX



E27 (GLS-CFL-LED)		max 60W max 160 mm	.E27
	6 W	800 Lm	2700 K .F1R
	8 W	1000 Lm	2700 K .M1R
	12 W	1500 Lm	2700 K .N1R

- PERFECT MATCHING WITH CLASSIC LANTERNS:** clear LED filament lamp with the look and the feeling of a traditional incandescent bulb.
- SUITABLE FOR OUTDOOR USE:** 100-240 V built-in driver fully protected against heat and humidity by silicone paste.
- OMNIDIRECTIONAL LIGHT:** 360° light output for a better lighting distribution on hexagonal and square classic lanterns.
- HIGH EFFICIENCY:** 90% energy saving.

6W  
8W  
12W = 60W  
75W  
100W incandescent

**SAVE 90%**

**LED LAMPS**



More technical details about TÜV approved Fumagalli LED Lamps on page 468.

\* ADD THESE SUFFIXES TO THE REFERENCES MENTIONED IN THE CATALOGUE

**PHOTOMETRIC DATA SAMPLE**

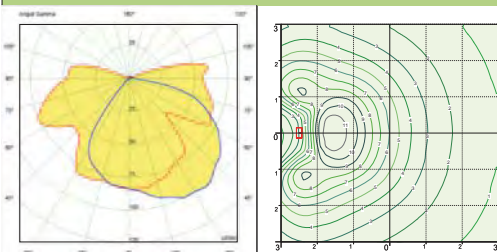

**IESSE lantern clear with Fumagalli Filament Led Lamp 6W.**

height wall mounting: 2mt  
6x6mt area: average 4 lux

The photometric data for all the versions are available upon request or on our website.

# DARIA

## LARGE SIZE



BULKHEAD  
FLOODLIGHT  
IN-GROUND  
BRICKLIGHT  
BOLLARDS  
GARDEN  
URBAN CLASSIC  
URBAN MODERN  
HIGH-BAY  
POST  
LAMPS

Half lantern in classic style, made of shockproof resin material, UV-rays stabilized, rust and corrosion-free. E27 version with support for ballast fixation or supplied with TÜV approved, long-life and efficient **LED filament lamps** suitable for outdoor use. Insulation class II, protection rating IP 55.

*Mezza lanterna in stile classico, realizzata in resina antiurto, stabilizzata ai raggi UV, inattaccabile da ruggine e corrosione. Versione E27 idonea all'utilizzo di reattori o fornita completa di **lampadine LED a filamento** adatte ad uso in ambiente esterno, approvate TÜV, di lunga durata ed elevata efficienza. Classe di isolamento II, grado di protezione IP55.*

NEW FILAMENT LED

**INDOOR & OUTDOOR USE**

6W - 8W - 12W  
100-240 V



M28.000.N1R

MADE IN ITALY

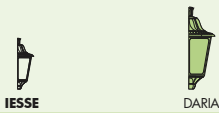

**DARIA - LANTERN COMPONENTS**

**IP55**



**CAGE** made of shockproof resin material, UV rays stabilized, rust and corrosion-free.

**GABBIA** realizzata in resina antiurto, stabilizzata ai raggi UV, inattaccabile da ruggine e corrosione.

**DIFFUSER** made of UV stabilized polymethylmethacrylate (PMMA) resistant to yellowing process due to sun rays, available in clear or opal color and made of one piece only.

**DIFFUSORE** in polimetilmetacrilato (PMMA) resistente al processo di ingiallimento dovuto ai raggi solari, disponibile in colore trasparente od opale e realizzato in un pezzo unico.

High temperature resistant **WALL PLATE** made of white polycarbonate (PC), with support for ballast fixation. Supplied complete with E27 lampholder.

**BASE A MURO** realizzata in policarbonato (PC) bianco ad alta resistenza al calore, con supporto per il fissaggio dei reattori. Fornita completa di portalamпада E27.

**DARIA**

<b>E27</b>	M28.000.E27
<b>8W LED</b>	M28.000.M1R
<b>12W LED</b>	M28.000.N1R

Pcs 1  
Kg 2,3  
mc 0,03

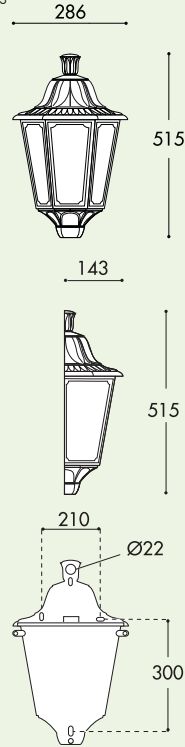

**DARIA**

M28.000 \*



**Dimensions and weight**

Height: 515 mm  
Width: 286 mm  
Depth: 143 mm  
Weight: 2,3 Kg

**Moulded colours:**

Black White

**Painted colours:**

Antique green Antique bronze

**Diffuser PMMA:**

Clear Opal

**E27**

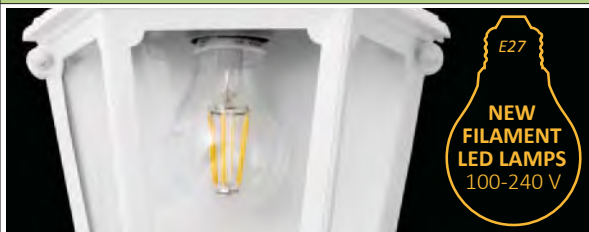

**E27**  
**NEW FILAMENT LED LAMPS**  
100-240 V

DARIA half lantern supplied with **E27** lampholder. Provided as an option with TÜV approved, long-life and efficient **LED filament lamps suitable for outdoor use** with built-in driver fully protected against heat and humidity by silicone paste.

\*ADD. SUFFIX

<b>E27</b> (GLS-CFL-LED)	max 100W	.E27
	<b>8 W</b>	<b>1000 Lm</b> 2700 K .N1R
	<b>12 W</b>	<b>1500 Lm</b> 2700 K .N1R

**E27 with BALLAST KIT**



DARIA half lantern supplied with E27 lampholder and **ballast kit** for SON-HQI lamps.

\*ADD. SUFFIX

<b>E27</b> WITH BALLAST	SON 70W	.S70
	HQI 70W	.H70

**LED LAMPS**



More technical details about TÜV approved Fumagalli LED Lamps on page 468.

\* ADD THESE SUFFIXES TO THE REFERENCES MENTIONED IN THE CATALOGUE

**PHOTOMETRIC DATA SAMPLE**

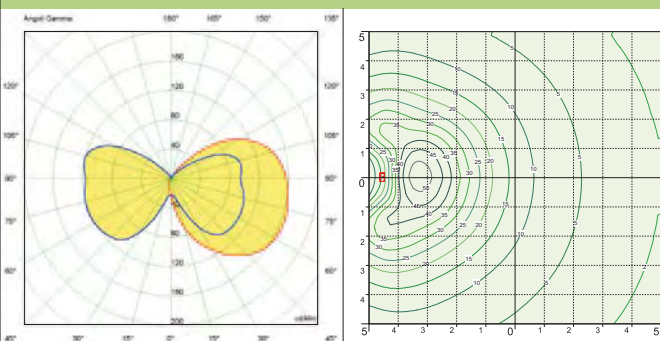

**DARIA lantern clear SON 70W.**

height wall mounting: 2,5mt  
10x10mt area: average 12 lux

The photometric data for all the versions are available upon request or on our website.

# GLOBE 250 CLASSIC

## SMALL SIZE

Ø 250 mm PMMA globe, complete with classic globe base made of shockproof resin material, UV-rays stabilized, rust and corrosion-free. Suitable for post top, hanging and wall installation. Supplied as optional with TÜV approved, long-life and efficient **LED filament lamps** suitable for outdoor use. Insulation class II, protection rating IP 55.

*Globo Ø 250 mm in polimetilmetacrilato (PMMA) completo di base classica realizzata in resina antiurto, stabilizzata ai raggi UV, inattaccabile da ruggine e corrosione. Idoneo per il montaggio a palo, a sospensione o a parete. Fornito anche completo di **lampadine LED a filamento** adatte ad uso in ambiente esterno, approvate TÜV, di lunga durata ed elevata efficienza. Classe di isolamento II, grado di protezione IP55.*



G25.131

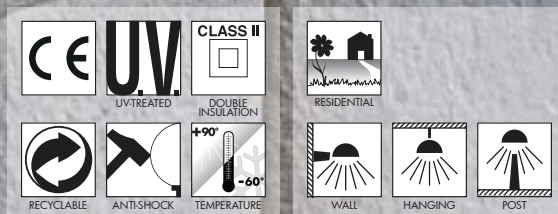

BULKHEAD  
FLOODLIGHT  
IN-GROUND  
BRICKLIGHT  
BOLLARDS  
GARDEN  
URBAN CLASSIC  
URBAN MODERN  
HIGH-BAY  
POST  
LAMPS

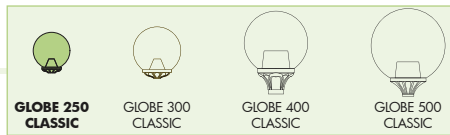

**GLOBE 250 CLASSIC - COMPONENTS**

**IP55**



Ø 250 mm **GLOBE** made of UV-rays stabilized polymethylmethacrylate (PMMA), one piece only. Available in clear, opal or smoked colour.

**GLOBO** Ø 250 mm in polimetilmetacrilato (PMMA), resistente all'ingiallimento ed ai raggi UV, realizzato in un unico pezzo. Disponibile nei colori trasparente, bianco o fumé.

Clear (X)

Opal (Y)

Smoked (Z)



**GLOBE BASE** with classic design, made of shockproof resin material, UV-rays stabilized, rust and corrosion-free. Supplied complete with E27 lampholder.

**REGGIBOCCIA** con disegno classico realizzato in resina antiurto, stabilizzato ai raggi UV, inattaccabile da ruggine e corrosione. Fornito completo di portalampana E27.

**GLOBE 250 CLASSIC**

G25.B25 \*



**Dimensions and weight**

Height: 260 mm  
Diameter: 250 mm  
Weight: 0,9 Kg

**Moulded colours:**

Black White

**Painted colours:**

Antique green Antique bronze

**Diffuser PMMA:**

Clear Opal Smoked

**E27 VERSIONS**



Globe supplied with **E27** base. Provided as an option with TÜV approved, long-life and efficient **LED filament lamps suitable for outdoor use** with built-in driver fully protected against heat and humidity by silicone paste.

E27 (GLS-CFL-LED)	max 60W max 160 mm			*ADD. SUFFIX .E27
	 FILAMENT LED LAMP	6 W	800 Lm	
	8 W	1000 Lm	2700 K	.M1R
	12 W	1500 Lm	2700 K	.N1R



**6W  
8W  
12W** = **60W  
75W  
100W** incandescent  
**SAVE 90%**

**LED LAMPS**

 More technical details about TÜV approved Fumagalli LED Lamps on page 468.

\*ADD THESE SUFFIXES TO THE REFERENCES MENTIONED IN THE CATALOGUE

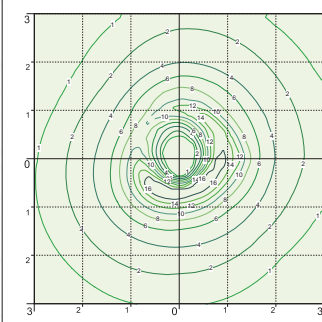
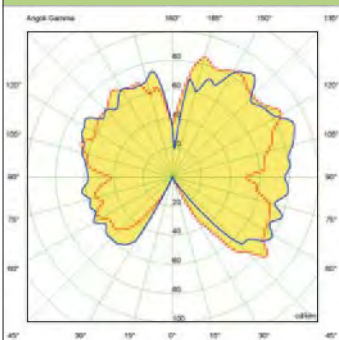
**PHOTOMETRIC DATA SAMPLE**



**GLOBE 250 CLASSIC** clear with Fumagalli Filament Led Lamp 6W.

POST height 1mt  
6x6mt area: average 4 lux

The photometric data for all the versions are available upon request or on our website.



**GLOBE 250 CLASSIC**  
SMALL SIZE

BULKHEAD

FLOODLIGHT

IN-GROUND

BRICKLIGHT

BOLLARDS

GARDEN

URBAN CLASSIC

URBAN MODERN

HIGH-BAY

POST

LAMPS

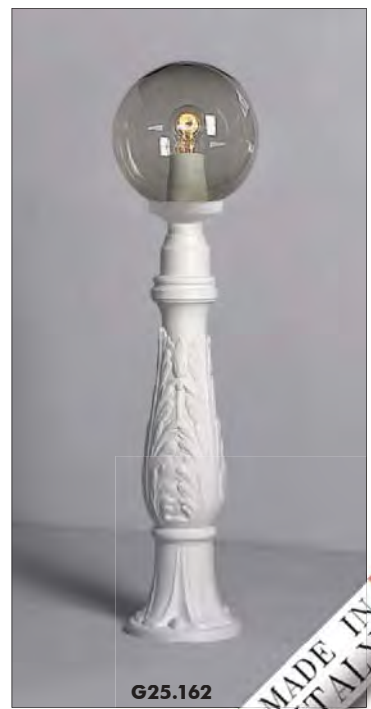

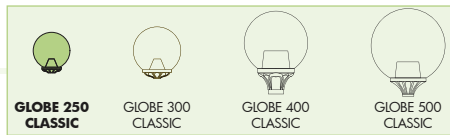

**MIKROLOT/G250**  
G25.110

Pcs 4  
Kg 6,2  
mc 0,0931

Ø 130

Ø 250

350

**MIZAR/G250**  
G25.151 resin

Pcs 4  
Kg 11,7  
mc 0,1456

Ø 150

Ø 250

1000

**IAFET.R/G250**  
G25.162 resin

Pcs 2  
Kg 6,9  
mc 0,092

Ø 190

Ø 250

950

**ALOE'.R/G250**  
G25.163 resin

Pcs 2  
Kg 7  
mc 0,122

Ø 190

Ø 250

1350

**GLOBE 250 CLASSIC**  
G25.B25

Pcs 2  
Kg 1,87  
mc 0,025

Ø 60

Ø 250

260

**BISSO/G250**  
G25.131

Pcs 4  
Kg 6,6  
mc 0,0931

300

360

Ø 250

Ø 250

300

**PORPORA/G250**  
G25.141

Pcs 2  
Kg 6,7  
mc 0,0931

600

370

Ø 250

Ø 250

**GIGI BISSO/G250 3L**  
G25.156.S30

Pcs 2  
Kg 25,4  
mc 0,31

620

2200

Ø 250

Ø 250

Ø 250

3

**RICU BISSO/G250 3L**  
G25.157.S30

Pcs 2  
Kg 27,5  
mc 0,339

620

2350

Ø 250

Ø 250

Ø 250

3

**ARTU'/G250**  
G25.158

Pcs 2  
Kg 16,4  
mc 0,186

Ø 245

Ø 250

1710

**GIGI/G250**  
G25.156

Pcs 2  
Kg 20  
mc 0,217

Ø 245

Ø 250

2000

**GIGI BISSO/G250 2L**  
G25.156.S20

Pcs 2  
Kg 23,7  
mc 0,27

670

2200

Ø 250

Ø 250

2

**RICU BISSO/G250 2L**  
G25.157.S20

Pcs 2  
Kg 24,8  
mc 0,304

670

2350

Ø 250

Ø 250

2

Ø 245

**SICHEM/G250**  
G25.120

Pcs 4  
Kg 5,7  
mc 0,0931

700

Ø 250

BULKHEAD  
FLOODLIGHT  
IN-GROUND  
BRICKLIGHT  
BOLLARDS  
GARDEN  
URBAN CLASSIC  
URBAN MODERN  
HIGH-BAY  
POST  
LAMPS

# GLOBE 300 CLASSIC

## MEDIUM SIZE

Ø 300 mm PMMA globe, complete with classic globe base made of shockproof resin material, UV-rays stabilized, rust and corrosion-free. Suitable for post top, hanging and wall installation. Supplied as optional with TÜV approved, long-life and efficient **LED filament lamps** suitable for outdoor use. Insulation class II, protection rating IP 55.

*Globo Ø 300 mm in polimetilmetacrilato (PMMA) completo di base classica realizzata in resina antiurto, stabilizzata ai raggi UV, inattaccabile da ruggine e corrosione. Idoneo per il montaggio a palo, a sospensione o a parete. Fornito anche completo di **lampadine LED a filamento** adatte ad uso in ambiente esterno, approvate TÜV, di lunga durata ed elevata efficienza. Classe di isolamento II, grado di protezione IP55.*

G30.111

G30.162

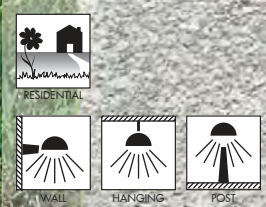
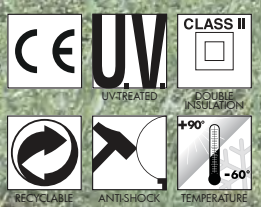

### GLOBE 300 CLASSIC - COMPONENTS

IP55



Ø 300 mm **GLOBE** made of UV-rays stabilized polymethylmethacrylate (PMMA), one piece only. Available in clear, opal or smoked colour.

**GLOBO** Ø 300 mm in polimetilmetacrilato (PMMA), resistente all'ingiallimento ed ai raggi UV, realizzato in un unico pezzo. Disponibile nei colori trasparente, bianco o fumé.



**GLOBE BASE** with classic design, made of shockproof resin material, UV-rays stabilized, rust and corrosion-free. Supplied complete with E27 lampholder.

**REGGIBOCCIA** con disegno classico realizzato in resina antiurto, stabilizzato ai raggi UV, inattaccabile da ruggine e corrosione. Fornito completo di portalampana E27.

### GLOBE 300 CLASSIC

G30.B30 \*

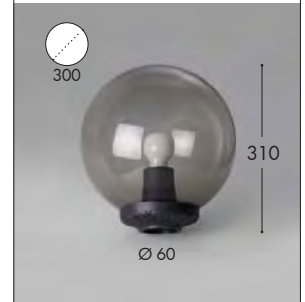

#### Dimensions and weight

Height: 310 mm  
Diameter: 300 mm  
Weight: 1,4 Kg

#### Moulded colours:

Black White

#### Painted colours:

Antique green Antique bronze

#### Diffuser PMMA:

Clear Opal Smoked

### E27 VERSIONS



Globe supplied with E27 base. Provided as an option with TÜV approved, long-life and efficient **LED filament lamps suitable for outdoor use** with built-in driver fully protected against heat and humidity by silicone paste.

E27 (GLS-CFL-LED)	max 75W max 190 mm	*ADD SUFFIX .E27
 6 W	800 Lm	2700 K .F1R
8 W	1000 Lm	2700 K .M1R
12 W	1500 Lm	2700 K .N1R



6W  
8W  
12W = 60W  
75W  
100W  
incandescent

**SAVE 90%**

### LED LAMPS



More technical details about TÜV approved Fumagalli LED Lamps on page 468.

\* ADD THESE SUFFIXES TO THE REFERENCES MENTIONED IN THE CATALOGUE

### PHOTOMETRIC DATA SAMPLE

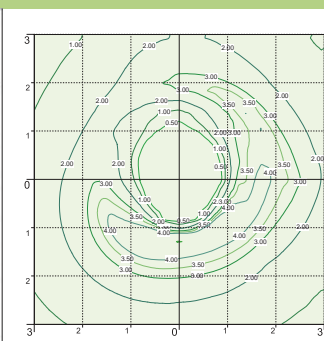
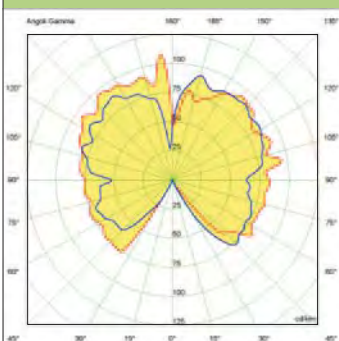

**GLOBE 300 CLASSIC** clear with Fumagalli Filament Led Lamp 6W.

POST height 2mt  
6x6mt area: average 2,5 lux

The photometric data for all the versions are available upon request or on our website.

**GLOBE 300 CLASSIC**  
MEDIUM SIZE

BULKHEAD

FLOODLIGHT

IN-GROUND

BRICKLIGHT

BOLLARDS

GARDEN

URBAN CLASSIC

URBAN MODERN

HIGH-BAY

POST

LAMPS

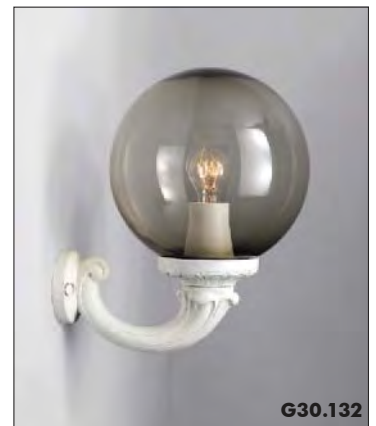
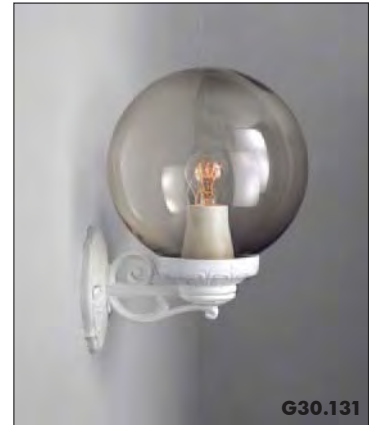

MADE IN ITALY



**RICU BISSO/G300 2L**  
G30.157.S20

Pcs 1  
Kg 24,4  
mc 0,237

**RICU BISSO/G300 3L**  
G30.157.S30

Pcs 1  
Kg 24,4  
mc 0,237

**BISSO/G300**  
G30.131

Pcs 4  
Kg 6  
mc 0,120

**SICHEM/G300**  
G30.120

Pcs 4  
Kg 6  
mc 0,120

**GLOBE 300 CLASSIC**  
G30.B30

Pcs 2  
Kg 2,8  
mc 0,059

**RICU OFIR/G300 2L**  
G30.157.R20

Pcs 2  
Kg 30,2  
mc 0,379

**RICU OFIR/G300 3L**  
G30.157.R30

Pcs 2  
Kg 34  
mc 0,439

**OFIR/G300**  
G30.132

Pcs 4  
Kg 6  
mc 0,120

**MINILOT/G300**  
G30.111

Pcs 4  
Kg 8  
mc 0,143

**RICU/G300**  
G30.157

Pcs 2  
Kg 21,5  
mc 0,274

**GIGI/G300**  
G30.156

Pcs 2  
Kg 20,4  
mc 0,242

**ARTU'/G300**  
G30.158

Pcs 2  
Kg 16,8  
mc 0,211

**ALOE'.R/G300**  
G30.163

Pcs 2  
Kg 7,4  
mc 0,146

**MIRRA/G300**  
G30.142

Pcs 2  
Kg 8,6  
mc 0,143

**IAFET.R/G300**  
G30.162 resin

Pcs 2  
Kg 7,3  
mc 0,117

BULKHEAD  
FLOODLIGHT  
IN-GROUND  
BRICKLIGHT  
BOLLARDS  
GARDEN  
URBAN CLASSIC  
URBAN MODERN  
HIGH-BAY  
POST  
LAMPS

# GLOBE 300 CLASSIC

## MEDIUM SIZE

BULKHEAD  
FLOODLIGHT  
IN-GROUND  
BRICKLIGHT  
BOLLARDS  
GARDEN  
URBAN CLASSIC  
URBAN MODERN  
HIGH-BAY  
POST  
LAMPS





**NEBO/G300**  
**G30.201**

Pcs 1  
Kg 19  
mc 0,163

Ø 300

2800

Ø 275

**NEBO OFIR/G300 2L**  
**G30.201.R20**

Pcs 1  
Kg 22,9  
mc 0,208

820

Ø 300

2900

Ø 275

2

**NEBO OFIR/G300 3L**  
**G30.201.R30**

Pcs 1  
Kg 24,4  
mc 0,237

860

Ø 300

2900

Ø 275

3



# GLOBE 300 MODERN

MEDIUM SIZE

Ø 300 mm PMMA globe, complete with modern globe base made of shockproof resin material, UV-rays stabilized, rust and corrosion-free. Suitable for post top or wall installation. Supplied as optional with TÜV approved, long-life and efficient **LED filament lamps** suitable for outdoor use. Insulation class II, protection rating IP 55.

*Globo Ø 300 mm in polimetilmetacrilato (PMMA) completo di base moderna realizzata in resina antiurto, stabilizzata ai raggi UV, inattaccabile da ruggine e corrosione. Idoneo per il montaggio a palo o a parete. Fornito anche completo di lampadine LED a filamento adatte ad uso in ambiente esterno, approvate TÜV, di lunga durata ed elevata efficienza. Classe di isolamento II, grado di protezione IP55.*

G31.262

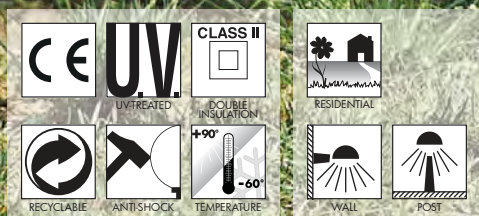

MADE IN ITALY



**GLOBE 300 MODERN - COMPONENTS**

IP55



Ø 300 mm **GLOBE** made of UV-rays stabilized polymethylmethacrylate (PMMA), one piece only. Available in clear, opal or smoked colour.

**GLOBO** Ø 300 mm in polimetilmetacrilato (PMMA), resistente all'ingiallimento ed ai raggi UV, realizzato in un unico pezzo. Disponibile nei colori trasparente, bianco o fumé.



**GLOBE BASE** with modern design made of shockproof resin material, UV-rays stabilized, rust and corrosion-free. Supplied complete with E27 lampholder.

**REGGIBOCCIA** con disegno moderno realizzato in resina antiurto, stabilizzato ai raggi UV, inattaccabile da ruggine e corrosione. Fornito completo di portalamпада E27.

**GLOBE 300 MODERN**

G31.B30 \*

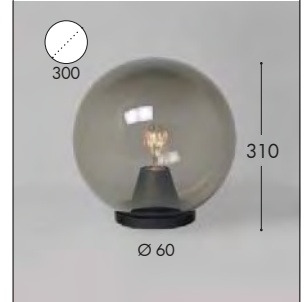

**Dimensions and weight**

Height: 310 mm  
Diameter: 300 mm  
Weight: 1,4 Kg

**Moulded colours:**

Black White

**Diffuser PMMA:**

Clear Opal Smoked

**E27 VERSIONS**



E27 (GLS-CFL-LED)	max 75W max 190 mm	* ADD SUFFIX .E27
6 W	800 Lm	2700 K .F1R
8 W	1000 Lm	2700 K .M1R
12 W	1500 Lm	2700 K .N1R

Globe supplied with E27 base. Provided as an option with TÜV approved, long-life and efficient LED filament lamps suitable for outdoor use with built-in driver fully protected against heat and humidity by silicone paste.

6W  
8W  
12W = 60W  
75W  
100W incandescent

**SAVE 90%**

**LED LAMPS**



More technical details about TÜV approved Fumagalli LED Lamps on page 468.

\* ADD THESE SUFFIXES TO THE REFERENCES MENTIONED IN THE CATALOGUE

**PHOTOMETRIC DATA SAMPLE**

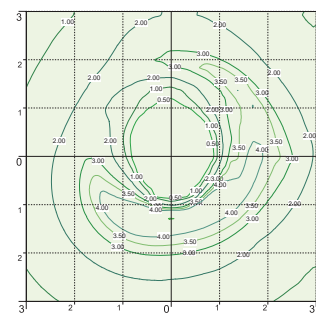
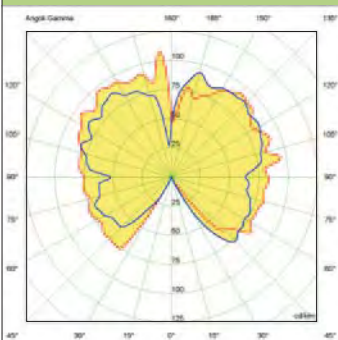

**GLOBE 300 MODERN** clear with Fumagalli Filament Led Lamp 6W.

POST height 2mt  
6x6mt area: average 2,5 lux

The photometric data for all the versions are available upon request or on our website.

# GLOBE 300 MODERN

MEDIUM SIZE

BULKHEAD  
FLOODLIGHT  
IN-GROUND  
BRICKLIGHT  
BOLLARDS  
GARDEN  
URBAN CLASSIC  
URBAN MODERN  
HIGH-BAY  
POST  
LAMPS

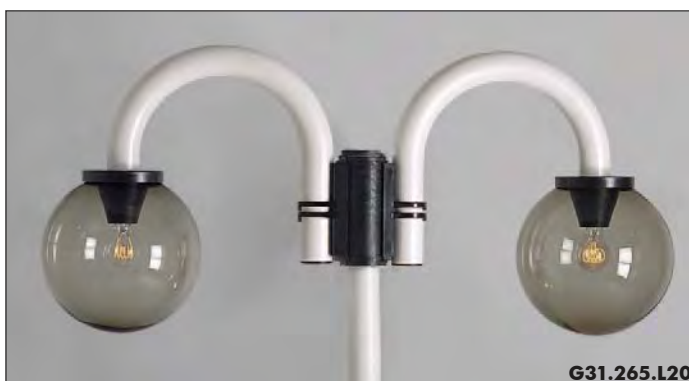
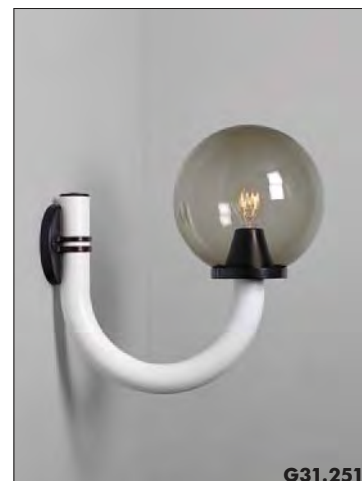



**ILIO/GLOBE 300**  
G31.251

Pcs 2  
Kg 5,7  
mc 0,1144

<b>ELISSA 1400/ELISSA 1900/</b> G300		<b>ELISSA 1900/</b> G300	
G31.280	G31.281	G31.280	G31.281
Pcs 2 Kg 9,2 mc 0,200	Pcs 2 Kg 15,9 mc 0,232	Pcs 2 Kg 9,2 mc 0,200	Pcs 2 Kg 15,9 mc 0,232

<b>ORIONE</b> 2450/G300		<b>ORIONE</b> 2850/G300	
G31.284	G31.285	G31.284	G31.285
Pcs 2 Kg 24,7 mc 0,225	Pcs 2 Kg 28,4 mc 0,246	Pcs 2 Kg 24,7 mc 0,225	Pcs 2 Kg 28,4 mc 0,246

<b>ENEA 2000 ELI/</b> G300 3L		<b>ENEA 2400 ELI/</b> G300 3L	
G31.264.L30	G31.265.L30	G31.264.L30	G31.265.L30
Pcs 2 Kg 36,7 mc 0,400	Pcs 2 Kg 40,4 mc 0,421	Pcs 2 Kg 36,7 mc 0,400	Pcs 2 Kg 40,4 mc 0,421

**ARGO/G300**  
G31.241 resin

Pcs 4  
Kg 6,7  
mc 0,148

**FEBO 500/G300**  
G31.261 resin

Pcs 2  
Kg 6  
mc 0,117

**FEBO 1500/G300**  
G31.263

Pcs 2  
Kg 13,9  
mc 0,178

<b>ENEA 2000/</b> G 300		<b>ENEA 2400/</b> G 300	
G31.264	G31.265	G31.264	G31.265
Pcs 2 Kg 22,7 mc 0,171	Pcs 2 Kg 26,4 mc 0,192	Pcs 2 Kg 22,7 mc 0,171	Pcs 2 Kg 26,4 mc 0,192

<b>ENEA 2000 ELI/</b> G300 2L		<b>ENEA 2400 ELI/</b> G300 2L	
G31.264.L20	G31.265.L20	G31.264.L20	G31.265.L20
Pcs 2 Kg 33,1 mc 0,340	Pcs 2 Kg 36,8 mc 0,361	Pcs 2 Kg 33,1 mc 0,340	Pcs 2 Kg 36,8 mc 0,361

BULKHEAD

FLOODLIGHT

IN-GROUND

BRICKLIGHT

BOLLARDS

GARDEN

URBAN CLASSIC

URBAN MODERN

HIGH-BAY

POST

LAMPS

	LAMPS
	POST
	HIGH-BAY
	URBAN MODERN
	URBAN CLASSIC
	GARDEN
	BOLLARDS
	BRICKLIGHT
	IN-GROUND
	FLOODLIGHT
	BULKHEAD

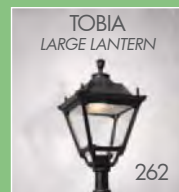

# URBAN CLASSIC

BULKHEAD

FLOODLIGHT

IN-GROUND

BRICKLIGHT

BOLLARDS

GARDEN

URBAN MODERN

HIGH-BAY

POST

LAMPS

# NOEMI

## LARGE SIZE

E27 hexagonal lantern in classic style, made of shockproof resin material, UV-rays stabilized, rust and corrosion-free. Modular construction suitable for post top, hanging and wall installation. Provided with high temperature resistant ceiling suitable for ballast fixation. Insulation class II, protection rating IP 55.

*Lantern esagonale E27 in stile classico, realizzata in resina antiurto, stabilizzata ai raggi UV, inattaccabile da ruggine e corrosione. Idonea per il montaggio a palo, a sospensione o a parete. Fornita con soffitto ad alta resistenza al calore idoneo per il fissaggio dei reattori. Classe di isolamento II, grado di protezione IP55.*

E35.121

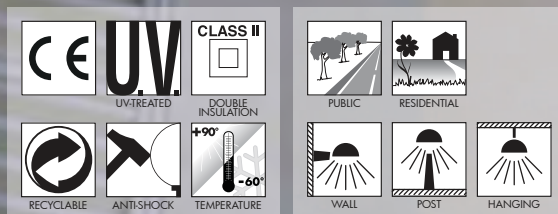

BULKHEAD  
FLOODLIGHT  
IN-GROUND  
BRICKLIGHT  
BOLLARDS  
GARDEN  
URBAN CLASSIC  
URBAN MODERN  
HIGH-BAY  
POST  
LAMPS



**NOEMI - LANTERN COMPONENTS**

**IP55**



Decorative **PINNACLE** to be mounted on the roof top for post installation or on the lantern base for hanging installation.

**PINNACOLO** decorativo applicabile alla sommità del tetto (montaggio a palo) o sulla base della gabbia (montaggio a sospensione).

Lantern **ROOF** made of shockproof resin material, UV-rays stabilized. Tool-free opening for relamping and access to control-gear.

**TETTO** realizzato in resina antiurto, stabilizzata ai raggi UV. Rimovibile senza l'ausilio di attrezzi per manutenzione e cambio lampadina.

Luminaire **DIFFUSER** of UV stabilized PMMA, one piece only, with recess for a power supply cable, available in clear or opal colour.

**DIFFUSORE** in polimetilmetacrilato resistente ai raggi UV, disponibile in colore trasparente od opale, provvisto di sede per l'alloggiamento del cavo di alimentazione. Realizzato in unico pezzo chiuso alla base per garantire un alto livello di protezione contro gli agenti esterni.

**CAGE** made of shockproof resin material, UV-rays stabilized, rust and corrosion-free.

**GABBIA** realizzata in resina antiurto, stabilizzata ai raggi UV, inattaccabile da ruggine e corrosione.

**NOEMI**

E35.000 \*



**Dimensions and weight**

Height: 530 mm  
Width: 350 mm  
Depth: 305 mm  
Weight: 3,5 Kg  
Junction to support: diameter 60 mm  
Area exposed to wind pressure:  
CxS = m<sup>2</sup> 0,110

**Moulded colours:**

Black  White

**Painted colours:**

Antique green  Antique bronze

**Diffuser PMMA:**

Clear  Opal

**E27**



Lantern supplied with high temperature resistant **CEILING** made of white polycarbonate (PC), complete with **E27** lampholder. Provided as an option with TÜV approved, long-life and efficient **LED filament lamps suitable for outdoor use.**

\*ADD. SUFFIX

<b>E27</b> (GLS-CFL-LED)	E27 lampholder only	.E27	
	<b>8 W</b>	<b>1000 Lm</b>	<b>2700 K</b> .M1R
	<b>12 W</b>	<b>1500 Lm</b>	<b>2700 K</b> .N1R

**E27 with BALLAST KIT**



Lantern supplied with high temperature resistant **CEILING** made of white polycarbonate (PC), complete with E27 lampholder and **ballast kit** for SON-HQI lamps.

\*ADD. SUFFIX

<b>E27</b> WITH BALLAST KIT	SON 70W	.S70
	HQI 70W	.H70

**LED LAMPS**



More technical details about TÜV approved Fumagalli LED Lamps on page 468.

\* ADD THESE SUFFIXES TO THE REFERENCES MENTIONED IN THE CATALOGUE

**PHOTOMETRIC DATA SAMPLE**

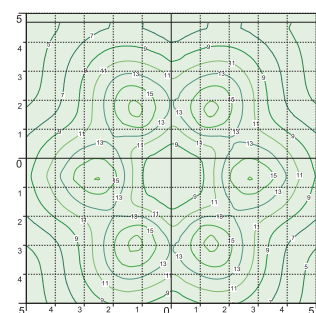
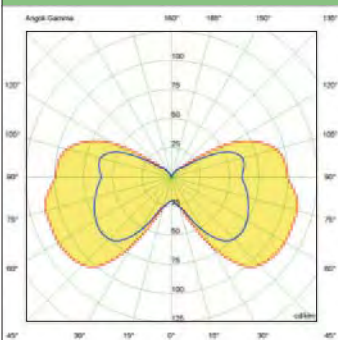

**NOEMI lantern clear SON 70W.**

**POST height 3mt**  
**10 x 10mt area: average 14 lux**

The photometric data for all the versions are available upon request or on our website.



# NOEMI LED

## LARGE SIZE

Hexagonal lantern in classic style, made of shockproof resin material, UV-rays stabilized, rust and corrosion-free. Modular construction suitable for post top, hanging and wall installation. Equipped with TÜV approved, long-life and efficient GX53 LED modular system in different wattages. Insulation class II, Protection rating IP 65.

*Lantern esagonale in stile classico, realizzata in resina antiurto, stabilizzata ai raggi UV, inattaccabile da ruggine e corrosione. Idonea per il montaggio a palo, a sospensione o a parete. Provvista di sistema modulare a LED GX53 approvato TÜV di lunga durata ed alta efficienza disponibile in diverse potenze. Classe di isolamento II, grado di protezione IP65.*

**E35.000.D3L**

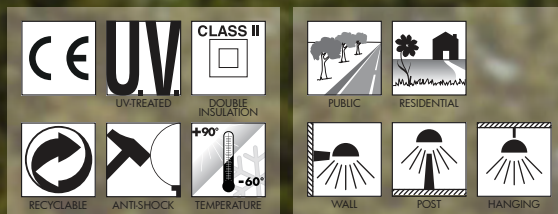

MADE IN  
ITALY

BULKHEAD

FLOODLIGHT

IN-GROUND

BRICKLIGHT

BOLLARDS

GARDEN

URBAN CLASSIC

URBAN MODERN

HIGH-BAY

POST

LAMPS



**NOEMI LED - LANTERN COMPONENTS**

IP65



Decorative **PINNACLE** to be mounted on the roof top for post installation or on the lantern base for hanging installation.

**PINNACOLO** decorativo applicabile alla sommità del tetto (montaggio a palo) o sulla base della gabbia (montaggio a sospensione).

Lantern **ROOF** made of shockproof resin material, UV-rays stabilized. Tool-free opening for relamping and maintenance.

**TETTO** realizzato in resina antiurto, stabilizzata ai raggi UV. Rimovibile senza l'ausilio di attrezzi per manutenzione e cambio lampadina.

Luminaires **DIFFUSER** of UV-rays stabilized polymethylmethacrylate (PMMA), with recess for a power supply cable, available in clear or opal colour. One piece only closed at the base to ensure high protection against external agents.

**DIFFUSORE** in polimetilmetacrilato resistente ai raggi UV, disponibile in colore trasparente od opale, provvisto di sede per l'alloggiamento del cavo di alimentazione. Realizzato in unico pezzo chiuso alla base per garantire un alto livello di protezione contro gli agenti esterni.

**CAGE** made of shockproof resin material, UV-rays stabilized, rust and corrosion-free.

**GABBIA** realizzata in resina antiurto, stabilizzata ai raggi UV, inattaccabile da ruggine e corrosione.

**NOEMI LED**

E35.000 \*



**Dimensions and weight**

Height: 530 mm  
Width: 350 mm  
Depth: 305 mm  
Weight: 4,1 Kg  
Junction to support: diameter 60 mm  
Area exposed to wind pressure: CxS = m<sup>2</sup> 0,110

**Moulded colours:**

Black White

**Painted colours:**

Antique green Antique bronze

**Diffuser PMMA:**

Clear Opal

**GX53 LED**



- **COST SAVING:** long-life and efficient LED light sources.
- **BUILT-IN DRIVER:** quick and easy lamp replacement
- **GREAT FLEXIBILITY:** GX53 standard lamp holder.
- **FUTURE-PROOFED LUMINARIES:** performances easy to upgrade to latest technology developments.
- **SUITABLE FOR OUTDOOR USE:** built-in driver fully protected against heat and humidity by silicone paste.

\*ADD. SUFFIX

Lantern supplied with white resin CEILING provided with TÜV approved, long-life and efficient **3x GX53 LED lamps included**. Each lamp can be quickly and easily replaced individually, making the luminaries maintenance very simple.



3x 7 W  
**21 W**

**2400 Lm**

4000 K .C3L

3000 K .C3R

3x 10 W  
**30 W**

**3600 Lm**

4000 K .D3L

3000 K .D3R

**LED LAMPS**



More technical details about TÜV approved Fumagalli LED Lamps on page 468.

\* ADD THESE SUFFIXES TO THE REFERENCES MENTIONED IN THE CATALOGUE

**PHOTOMETRIC DATA SAMPLE**

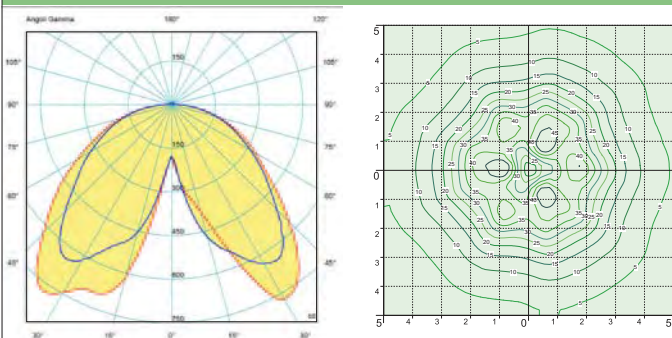

**NOEMI LED**



SAVE **-58%**

3x10W GX53 LED  
**30W**  
(power consumption)

Area: 10x10mt  
Height: 3mt  
**15 lux**

=

**NOEMI E27**



HQI - SON  
**70W**  
(power consumption)

Area: 10x10mt  
Height: 3mt  
**14 lux**

**NOEMI**  
LARGE SIZE



BULKHEAD  
FLOODLIGHT  
IN-GROUND  
BRICKLIGHT  
BOLLARDS  
GARDEN  
URBAN CLASSIC  
URBAN MODERN  
HIGH-BAY  
POST  
LAMPS

MADE IN ITALY



**OFIR/NOEMI**  
E35.132

Pcs 1  
Kg 4,4  
mc 0,048

**EVA/NOEMI**  
E35.181

Pcs 1  
Kg 13  
mc 0,168

**NOEMI**  
E35.000

Pcs 1  
Kg 3,5  
mc 0,043

**LOT/NOEMI**  
E35.113

Pcs 1  
Kg 4,4  
mc 0,061

**MIRRA/NOEMI**  
E35.142

Pcs 1  
Kg 11  
mc 0,083

**SICHEM/NOEMI**  
E35.121

Pcs 1  
Kg 4,4  
mc 0,048

**RICU/NOEMI**  
E35.157

Pcs 2  
Kg 25,8  
mc 0,310

**GIGI/NOEMI**  
E35.156

Pcs 2  
Kg 24,9  
mc 0,278

**ARTU'/NOEMI**  
E35.158

Pcs 2  
Kg 21,4  
mc 0,247

**ALOE'.R/NOEMI**  
E35.163 resin

Pcs 2  
Kg 11,8  
mc 0,182

**IAFET.R/NOEMI**  
E35.162 resin

Pcs 2  
Kg 11,7  
mc 0,153

BULKHEAD  
FLOODLIGHT  
IN-GROUND  
BRICKLIGHT  
BOLLARDS  
GARDEN  
URBAN CLASSIC  
URBAN MODERN  
HIGH-BAY  
POST  
LAMPS

NEBO/NOEMI  
LARGE SIZE

BULKHEAD

FLOODLIGHT

IN-GROUND

BRICKLIGHT

BOLLARDS

GARDEN

URBAN CLASSIC

URBAN MODERN

HIGH-BAY

POST

LAMPS

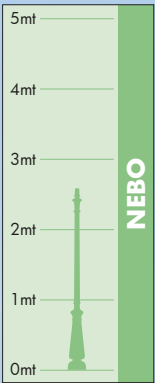



**NEBO OFIR/NOEMI 2L**  
**E35.201.R20**

Pcs 1  
Kg 26,9  
mc 0,268

**NEBO OFIR/NOEMI 3L**  
**E35.201.R30**

Pcs 1  
Kg 29,4  
mc 0,342

**NEBO/NOEMI**  
**E35.201**

Pcs 1  
Kg 21,7  
mc 0,196

**NEBO OFIR/NOEMI 2L**  
**E35.201.R20**

Pcs 1  
Kg 26,9  
mc 0,268

**NEBO OFIR/NOEMI 3L**  
**E35.201.R30**

Pcs 1  
Kg 29,4  
mc 0,342

TABOR/NOEMI  
LARGE SIZE

BULKHEAD  
FLOODLIGHT  
IN-GROUND  
BRICKLIGHT  
BOLLARDS  
GARDEN  
URBAN CLASSIC  
URBAN MODERN  
HIGH-BAY  
POST  
LAMPS





**TABOR OFIR/NOEMI 2L**  
**E35.204.R20**

Pcs 1  
Kg 32,2  
mc 0,295

**TABOR OFIR/NOEMI 3L**  
**E35.204.R30**

Pcs 1  
Kg 34,6  
mc 0,369

**TABOR/NOEMI**  
**E35.204**

Pcs 1  
Kg 27  
mc 0,223

**TABOR OFIR/NOEMI 2L**  
**E35.204.R20**

Pcs 1  
Kg 32,2  
mc 0,295

**TABOR OFIR/NOEMI 3L**  
**E35.204.R30**

Pcs 1  
Kg 34,6  
mc 0,369



HOREB/NOEMI  
LARGE SIZE

BULKHEAD  
FLOODLIGHT  
IN-GROUND  
BRICKLIGHT  
BOLLARDS  
GARDEN  
URBAN CLASSIC  
URBAN MODERN  
HIGH-BAY  
POST  
LAMPS

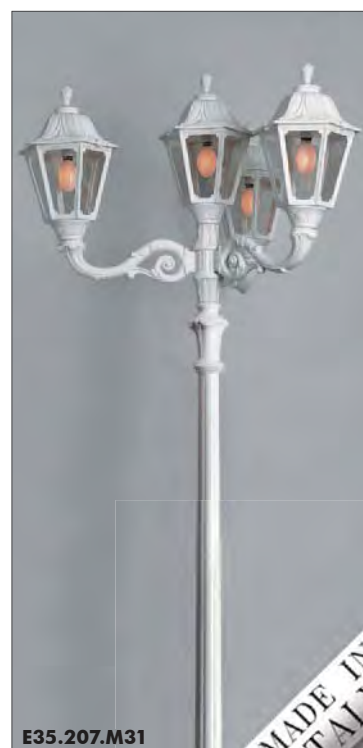
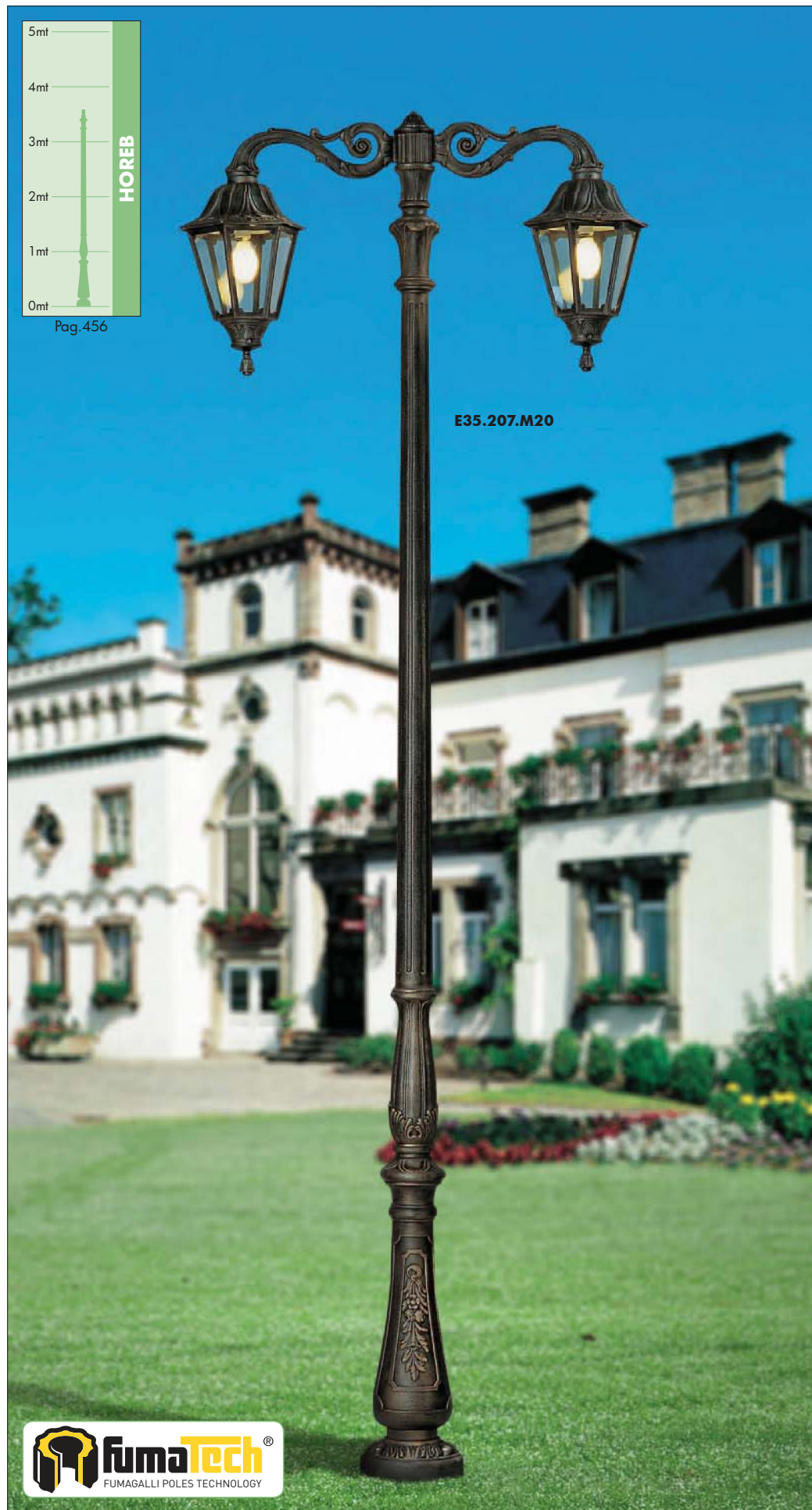

MADE IN ITALY



**HOREB ADAM/NOEMI 1L**  
**E35.207.M10**

Pcs 1  
Kg 30,4  
mc 0,280

**ADAM/NOEMI**  
**E35.171**

Pcs 1  
Kg 6,3  
mc 0,083

**HOREB ADAM/NOEMI 3+1**  
**E35.207.M31**

Pcs 1  
Kg 43,4  
mc 0,476

**HOREB/NOEMI**  
**E35.207**

Pcs 1  
Kg 28,5  
mc 0,249

**HOREB ADAM/NOEMI 2+1**  
**E35.207.M21**

Pcs 1  
Kg 38,8  
mc 0,404

**HOREB ADAM/NOEMI 3L**  
**E35.207.M30**

Pcs 1  
Kg 39,7  
mc 0,414

**HOREB ADAM/NOEMI 2L**  
**E35.207.M20**

Pcs 1  
Kg 35,1  
mc 0,342

BULKHEAD

FLOODLIGHT

IN-GROUND

BRICKLIGHT

BOLLARDS

GARDEN

URBAN CLASSIC

URBAN MODERN

HIGH-BAY

POST

LAMPS

KARMEL 3000/NOEMI  
LARGE SIZE

BULKHEAD  
FLOODLIGHT  
IN-GROUND  
BRICKLIGHT  
BOLLARDS  
GARDEN  
URBAN CLASSIC  
URBAN MODERN  
HIGH-BAY  
POST  
LAMPS

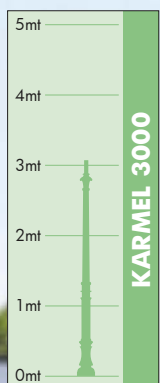

Pag.456





**KARMEL 3000 OFIR/NOEMI 2L**  
E35.231.R20

Pcs 1  
Kg 32,2  
mc 0,295

**KARMEL 3000 OFIR/NOEMI 3L**  
E35.231.R30

Pcs 1  
Kg 36,5  
mc 0,369

**KARMEL 3000/NOEMI**  
E35.231

Pcs 1  
Kg 27  
mc 0,223

**KARMEL 3000 OFIR/NOEMI 2L**  
E35.231.R20

Pcs 1  
Kg 32,2  
mc 0,295

**KARMEL 3000 OFIR/NOEMI 3L**  
E35.231.R30

Pcs 1  
Kg 36,5  
mc 0,369

KARMEL 3500-4000/**NOEMI**  
LARGE SIZE

BULKHEAD  
FLOODLIGHT  
IN-GROUND  
BRICKLIGHT  
BOLLARDS  
GARDEN  
URBAN CLASSIC  
URBAN MODERN  
HIGH-BAY  
POST  
LAMPS

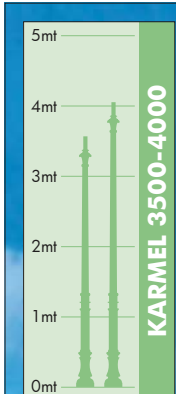

Pag.456

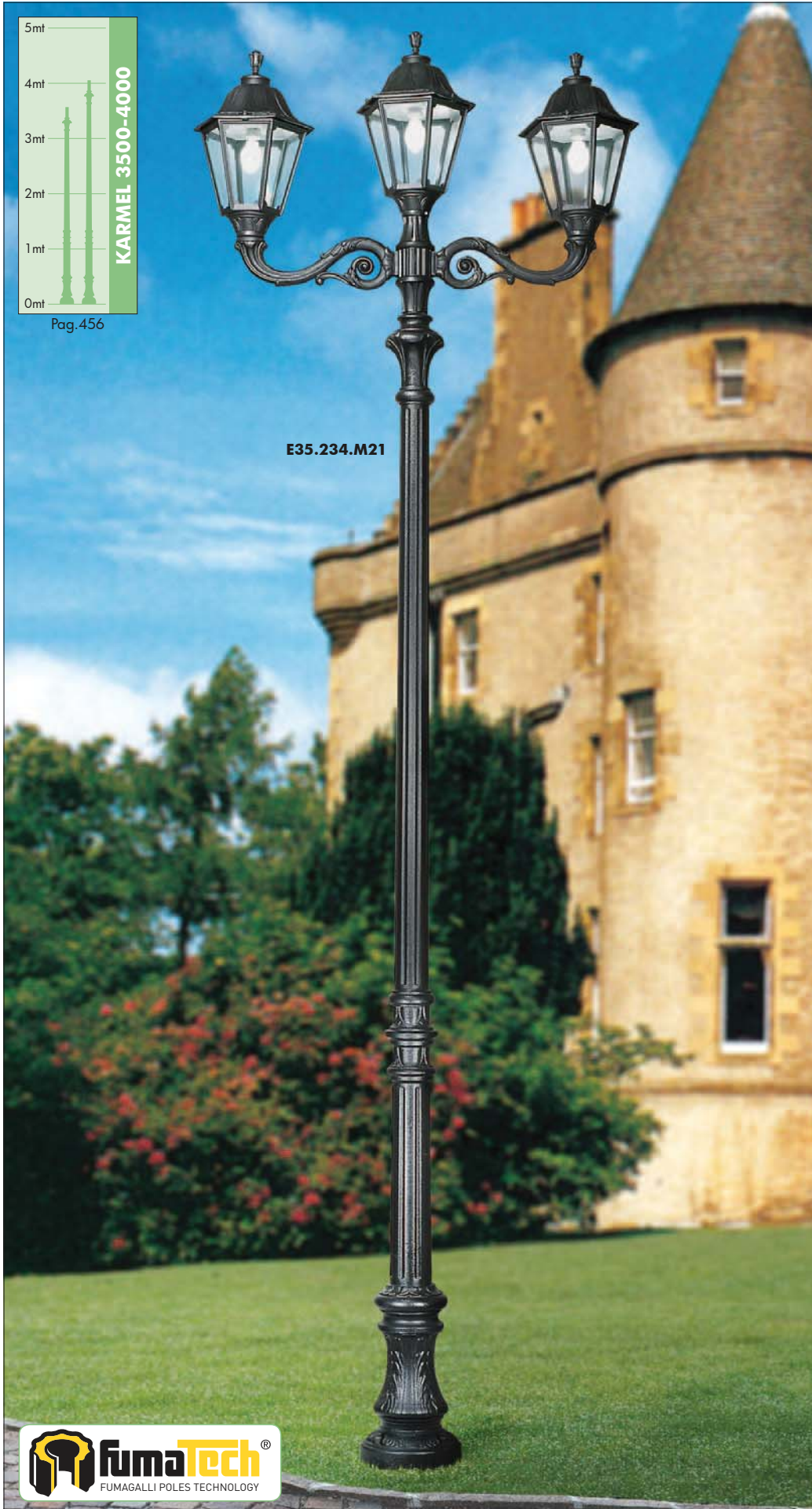

MADE IN ITALY



KARMEL 3500 ADAM/NOEMI 1L	KARMEL 4000 ADAM/NOEMI 1L
E35.234.M10	E35.237.M10
Pcs 1 Kg 30,4 mc 0,280	Pcs 1 Kg 33,9 mc 0,287

KARMEL 3500 ADAM/NOEMI 2+1	KARMEL 4000 ADAM/NOEMI 2+1
E35.234.M21	E35.237.M21
Pcs 1 Kg 38,8 mc 0,404	Pcs 1 Kg 42,3 mc 0,431

KARMEL 3500 ADAM/NOEMI 3L	KARMEL 4000 ADAM/NOEMI 3L
E35.234.M30	E35.237.M30
Pcs 1 Kg 39,7 mc 0,414	Pcs 1 Kg 43,2 mc 0,441

KARMEL 3500/NOEMI
E35.234
Pcs 1 Kg 28,5 mc 0,249

KARMEL 3500 ADAM/NOEMI 3+1	KARMEL 4000 ADAM/NOEMI 3+1
E35.234.M31	E35.237.M31
Pcs 1 Kg 43,4 mc 0,476	Pcs 1 Kg 46,9 mc 0,503

KARMEL 3500 ADAM/NOEMI 2L	KARMEL 4000 ADAM/NOEMI 2L
E35.234.M20	E35.237.M20
Pcs 1 Kg 35,1 mc 0,342	Pcs 1 Kg 38,7 mc 0,369

BULKHEAD  
FLOODLIGHT  
IN-GROUND  
BRICKLIGHT  
BOLLARDS  
GARDEN  
URBAN CLASSIC  
URBAN MODERN  
HIGH-BAY  
POST  
LAMPS

# SILOE

## LARGE SIZE

E27 hexagonal lantern in classic style, made of shockproof resin material, UV-rays stabilized, rust and corrosion-free. Modular construction suitable for post top, hanging and wall installation. Provided with high temperature resistant ceiling suitable for ballast fixation. Insulation class II, protection rating IP 55.

*Lanterna esagonale E27 in stile classico, realizzata in resina antiurto, stabilizzata ai raggi UV, inattaccabile da ruggine e corrosione. Idonea per il montaggio a palo, a sospensione o a parete. Fornita con soffitto ad alta resistenza al calore idoneo per il fissaggio dei reattori. Classe di isolamento II, grado di protezione IP55.*

K35.132

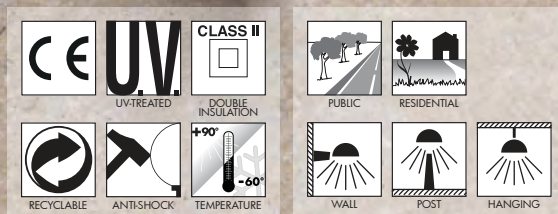

BULKHEAD  
FLOODLIGHT  
IN-GROUND  
BRICKLIGHT  
BOLLARDS  
GARDEN  
URBAN CLASSIC  
URBAN MODERN  
HIGH-BAY  
POST  
LAMPS

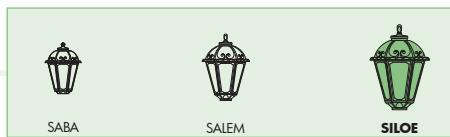

**SILOE - LANTERN COMPONENTS**

IP55



Decorative **PINNACLE** to be mounted on the roof top for post installation or on the lantern base for hanging installation.

**PINNACOLO** decorativo applicabile alla sommità del tetto (montaggio a palo) o sulla base della gabbia (montaggio a sospensione).

Lantern **ROOF** made of shockproof resin material, UV-rays stabilized. Tool-free opening for relamping and access to control-gear

**TETTO** realizzato in resina antiurto, stabilizzata ai raggi UV. Rimovibile senza l'ausilio di attrezzi per manutenzione e cambio lampadina.

**DIFFUSER** of UV-rays stabilized polymethylmethacrylate (PMMA), with recess for a power supply cable, available in clear or opal colour. One piece only closed at the base to ensure high protection against external agents.

**DIFFUSORE** in polimetilmetacrilato resistente ai raggi UV, disponibile in colore trasparente od opale, provvisto di sede per l'alloggiamento del cavo di alimentazione. Realizzato in unico pezzo chiuso alla base per garantire un alto livello di protezione contro gli agenti esterni.

**CAGE** made of shockproof resin material, UV-rays stabilized, rust and corrosion-free.

**GABBIA** realizzata in resina antiurto, stabilizzata ai raggi UV, inattaccabile da ruggine e corrosione.

**SILOE**

K35.000 \*



**Dimensions and weight**

Height: 530 mm  
Width: 350 mm  
Depth: 305 mm  
Weight: 3,5 Kg  
Junction to support: diameter 60 mm  
Area exposed to wind pressure:  
CxS = m<sup>2</sup> 0,113

**Moulded colours:**

Black  White

**Painted colours:**

Antique green  Antique bronze

**Diffuser PMMA:**

Clear  Opal

**E27**



Lantern supplied with high temperature resistant **CEILING** made of white polycarbonate (PC), complete with **E27** lampholder. Provided as an option with TÜV approved, long-life and efficient **LED filament lamps suitable for outdoor use.**

\*ADD. SUFFIX

<b>E27</b> (GLS-CFL-LED)	E27 lampholder only	.E27	
	<b>8 W</b>	<b>1000 Lm</b>	<b>2700 K</b> .M1R
	<b>12 W</b>	<b>1500 Lm</b>	<b>2700 K</b> .N1R

**E27 with BALLAST KIT**



Lantern supplied with high temperature resistant **CEILING** made of white polycarbonate (PC), complete with E27 lampholder and **ballast kit** for SON-HQI lamps.

\*ADD. SUFFIX

<b>E27</b> WITH BALLAST KIT	SON 70W	.S70
	HQI 70W	.H70

**LED LAMPS**



More technical details about TÜV approved Fumagalli LED Lamps on page 468.

\* ADD THESE SUFFIXES TO THE REFERENCES MENTIONED IN THE CATALOGUE

**PHOTOMETRIC DATA SAMPLE**

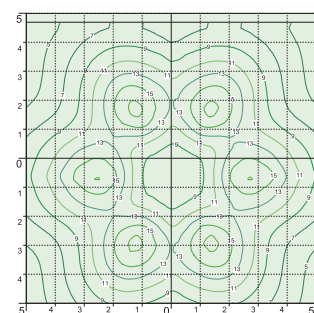
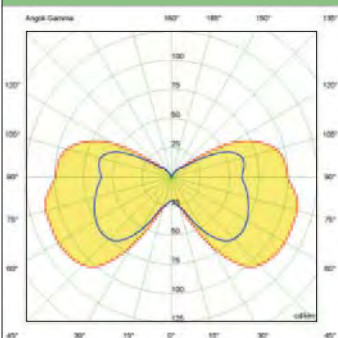

**SILOE lantern clear SON 70W.**

**POST height 3mt**  
**10 x 10mt area: average 14 lux**

The photometric data for all the versions are available upon request or on our website.



# SILOE LED

## LARGE SIZE

Hexagonal lantern in classic style, made of shockproof resin material, UV-rays stabilized, rust and corrosion-free. Modular construction suitable for post top, hanging and wall installation. Equipped with TÜV approved, long-life and efficient GX53 LED modular system in different wattages. Insulation class II, Protection rating IP 65.

*Lantern esagonale in stile classico, realizzata in resina antiurto, stabilizzata ai raggi UV, inattaccabile da ruggine e corrosione. Idonea per il montaggio a palo, a sospensione o a parete. Provvista di sistema modulare a LED GX53 approvato TÜV di lunga durata ed alta efficienza disponibile in diverse potenze. Classe di isolamento II, grado di protezione IP65.*

**K35.000.D3L**



BULKHEAD  
FLOODLIGHT  
IN-GROUND  
BRICKLIGHT  
BOLLARDS  
GARDEN  
URBAN CLASSIC  
URBAN MODERN  
HIGH-BAY  
POST  
LAMPS



**SILOE LED - LANTERN COMPONENTS**

**IP65**



Decorative **PINNACLE** to be mounted on the roof top for post installation or on the lantern base for hanging installation.

**PINNACOLO** decorativo applicabile alla sommità del tetto (montaggio a palo) o sulla base della gabbia (montaggio a sospensione).

Lantern **ROOF** made of shockproof resin material, UV-rays stabilized, rust and corrosion-free. Tool-free opening for relamping and maintenance.

**TETTO** realizzato in resina antiurto, stabilizzata ai raggi UV, inattaccabile da ruggine e corrosione. Rimovibile senza l'ausilio di attrezzi per manutenzione e cambio lampadina.

**DIFFUSER** of UV-rays stabilized polymethylmethacrylate (PMMA), with recess for a power supply cable, available in clear or opal colour. One piece only closed at the base to ensure high protection against external agents.

**DIFFUSORE** in polimetilmetacrilato resistente ai raggi UV, disponibile in colore trasparente od opale, provvisto di sede per l'alloggiamento del cavo di alimentazione. Realizzato in unico pezzo chiuso alla base per garantire un alto livello di protezione contro gli agenti esterni.

**CAGE** made of shockproof resin material, UV-rays stabilized, rust and corrosion-free.

**GABBIA** realizzata in resina antiurto, stabilizzata ai raggi UV, inattaccabile da ruggine e corrosione.

**SILOE LED**

K35.000 \*



**Dimensions and weight**

Height: 530 mm  
Width: 350 mm  
Depth: 305 mm  
Weight: 4,1 Kg  
Junction to support: diameter 60 mm  
Area exposed to wind pressure:  
CxS = m<sup>2</sup> 0,113

**Moulded colours:**

Black  White

**Painted colours:**

Antique green  Antique bronze

**Diffuser PMMA:**

Clear  Opal

**GX53 LED**



- **COST SAVING:** long-life and efficient LED light sources.
- **BUILT-IN DRIVER:** quick and easy lamp replacement
- **GREAT FLEXIBILITY:** GX53 standard lamp holder.
- **FUTURE-PROOFED LUMINARIES:** performances easy to upgrade to latest technology developments.
- **SUITABLE FOR OUTDOOR USE:** built-in driver fully protected against heat and humidity by silicone paste.

\*ADD. SUFFIX

Lantern supplied with white resin CEILING provided with TÜV approved, long-life and efficient **3x GX53 LED lamps included**. Each lamp can be quickly and easily replaced individually, making the luminaries maintenance very simple.



3x 7 W <b>21 W</b>	<b>2400 Lm</b>	4000 K	.C3L
		3000 K	.C3R
3x 10 W <b>30 W</b>	<b>3600 Lm</b>	4000 K	.D3L
		3000 K	.D3R

**LED LAMPS**



More technical details about TÜV approved Fumagalli LED Lamps on page 468.

\* ADD THESE SUFFIXES TO THE REFERENCES MENTIONED IN THE CATALOGUE

**PHOTOMETRIC DATA SAMPLE**

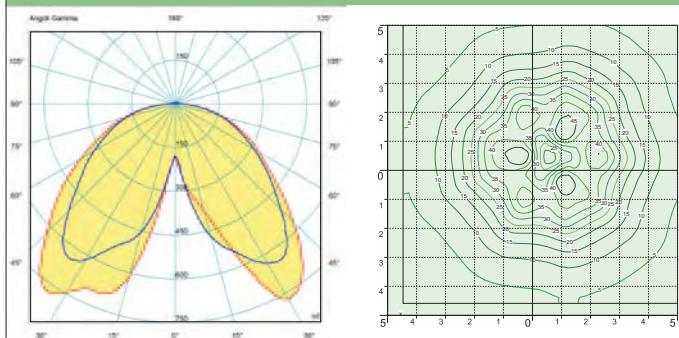

**SILOE LED**



**SAVE -58%**

3x10W GX53 LED  
**30W**  
(power consumption)

Area: 10x10mt  
Height: 3mt  
**15 lux**

**SILOE E27**



HQI - SON  
**70W**  
(power consumption)

Area: 10x10mt  
Height: 3mt  
**14 lux**

**SILOE**  
LARGE SIZE

BULKHEAD  
FLOODLIGHT  
IN-GROUND  
BRICKLIGHT  
BOLLARDS  
GARDEN  
URBAN CLASSIC  
URBAN MODERN  
HIGH-BAY  
POST  
LAMPS



MADE IN  
ITALY



**OFIR/SILOE**  
K35.132

Pcs 1  
Kg 4,4  
mc 0,048

**EVA/SILOE**  
K35.181

Pcs 1  
Kg 13  
mc 0,168

**SILOE**  
K35.000

Pcs 1  
Kg 3,5  
mc 0,043

**LOT/SILOE**  
K35.113

Pcs 1  
Kg 4,4  
mc 0,061

**MIRRA/SILOE**  
K35.142

Pcs 1  
Kg 11  
mc 0,083

**SICHEM/SILOE**  
K35.121

Pcs 1  
Kg 4,4  
mc 0,048

**RICU/SILOE**  
K35.157

Pcs 2  
Kg 25,8  
mc 0,310

**GIGI/SILOE**  
K35.156

Pcs 2  
Kg 24,9  
mc 0,278

**ARTU'/SILOE**  
K35.158

Pcs 2  
Kg 21,4  
mc 0,247

**ALOE'.R/SILOE**  
K35.163 resin

Pcs 2  
Kg 11,8  
mc 0,182

**IAFET.R/SILOE**  
K35.162 resin

Pcs 2  
Kg 11,7  
mc 0,153

BULKHEAD  
FLOODLIGHT  
IN-GROUND  
BRICKLIGHT  
BOLLARDS  
GARDEN  
URBAN CLASSIC  
URBAN MODERN  
HIGH-BAY  
POST  
LAMPS

NEBO/SILOE  
LARGE SIZE

BULKHEAD  
FLOODLIGHT  
IN-GROUND  
BRICKLIGHT  
BOLLARDS  
GARDEN  
URBAN CLASSIC  
URBAN MODERN  
HIGH-BAY  
POST  
LAMPS

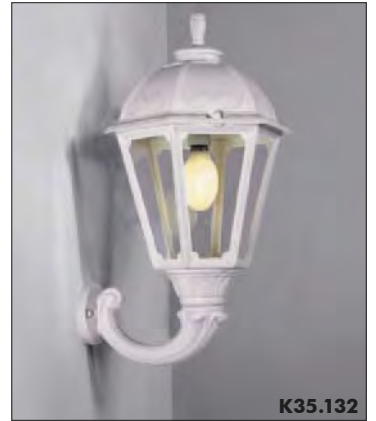
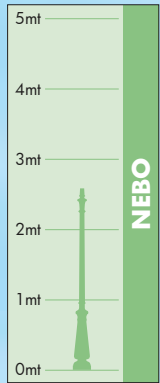

MADE IN ITALY



SABA



SALEM



SILOE

**NEBO OFIR/SILOE 2L**  
**K35.201.R20**

Pcs 1  
Kg 26,9  
mc 0,268

**NEBO OFIR/SILOE 3L**  
**K35.201.R30**

Pcs 1  
Kg 29,4  
mc 0,342

**NEBO/SILOE**  
**K35.201**

Pcs 1  
Kg 21,7  
mc 0,196

**NEBO OFIR/SILOE 2L**  
**K35.201.R20**

Pcs 1  
Kg 26,9  
mc 0,268

**NEBO OFIR/SILOE 3L**  
**K35.201.R30**

Pcs 1  
Kg 29,4  
mc 0,342

TABOR/SILOE  
LARGE SIZE

BULKHEAD  
FLOODLIGHT  
IN-GROUND  
BRICKLIGHT  
BOLLARDS  
GARDEN  
URBAN CLASSIC  
URBAN MODERN  
HIGH-BAY  
POST  
LAMPS

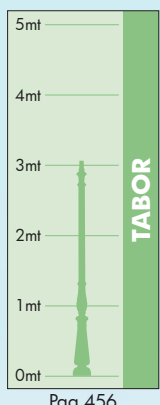
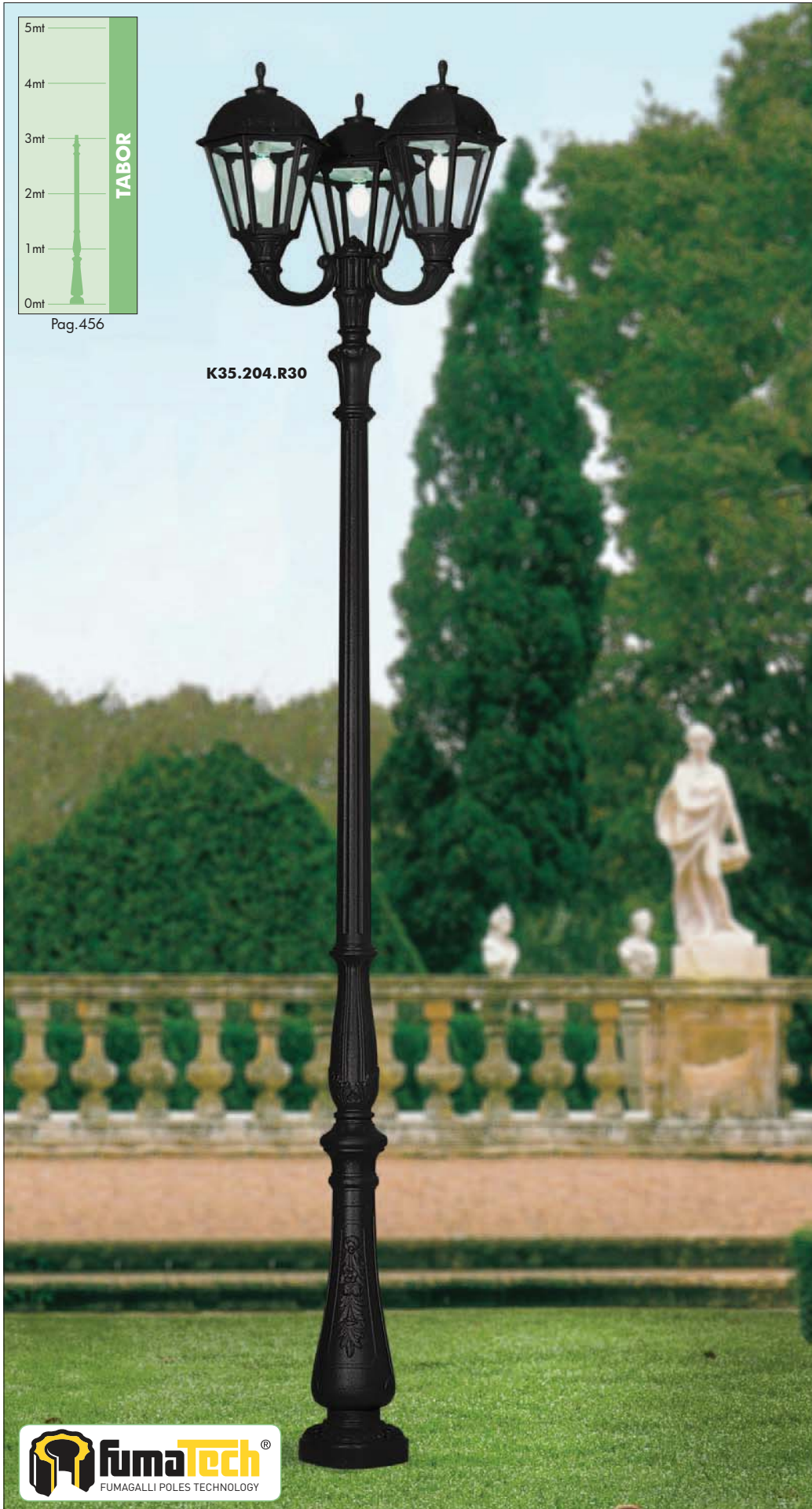

MADE IN ITALY



SABA



SALEM



SILOE

**TABOR OFIR/SILOE 2L**

K35.204.R20

Pcs 1  
Kg 32,2  
mc 0,295

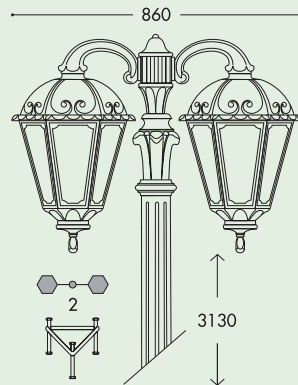

**TABOR OFIR/SILOE 3L**

K35.204.R30

Pcs 1  
Kg 34,6  
mc 0,369

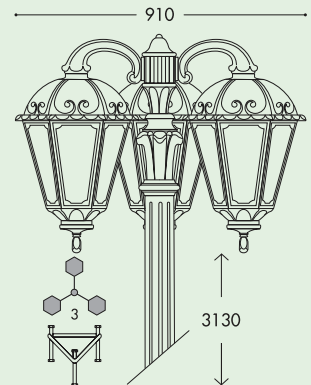

**TABOR/SILOE**

K35.204

Pcs 1  
Kg 27  
mc 0,223

350

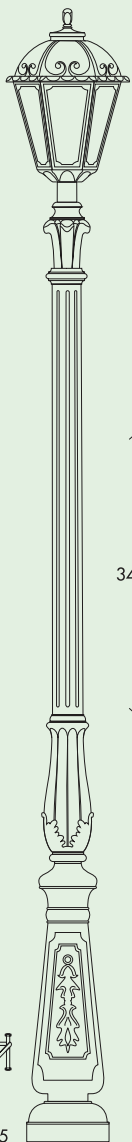

Ø 275

**TABOR OFIR/SILOE 2L**

K35.204.R20

Pcs 1  
Kg 32,2  
mc 0,295

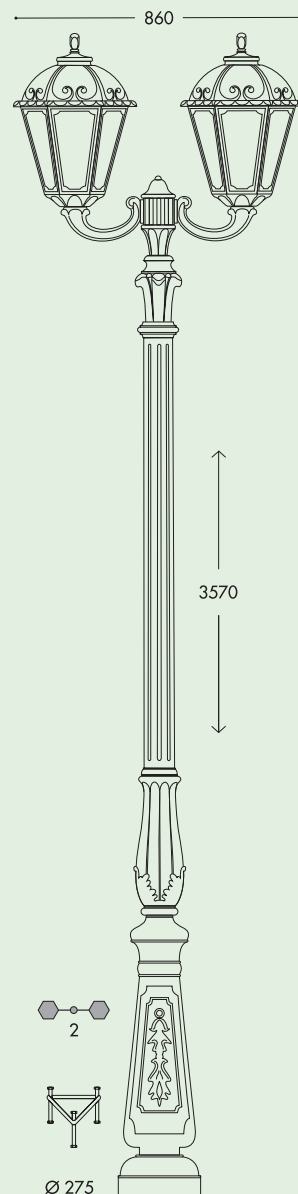

Ø 275

**TABOR OFIR/SILOE 3L**

K35.204.R30

Pcs 1  
Kg 34,6  
mc 0,369

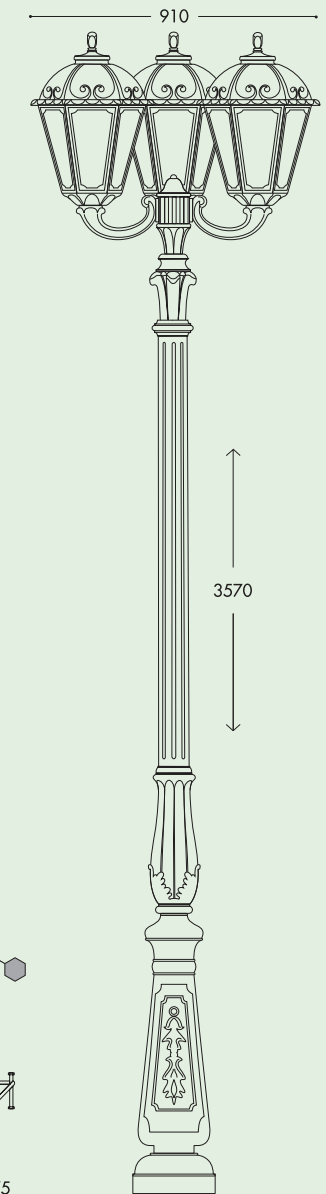

Ø 275



BULKHEAD  
FLOODLIGHT  
IN-GROUND  
BRICKLIGHT  
BOLLARDS  
GARDEN  
URBAN CLASSIC  
URBAN MODERN  
HIGH-BAY  
POST  
LAMPS

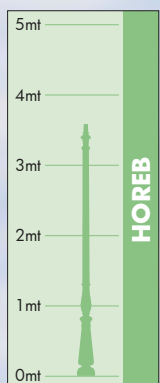

Pag.456





**HOREB ADAM/SILOE 1L**  
K35.207.M10

Pcs 1  
Kg 30,4  
mc 0,280

**ADAM/SILOE**  
K35.171

Pcs 1  
Kg 6,3  
mc 0,083

**HOREB ADAM/SILOE 3+1**  
K35.207.M31

Pcs 1  
Kg 43,4  
mc 0,476

**HOREB/SILOE**  
K35.207

Pcs 1  
Kg 28,5  
mc 0,249

**HOREB ADAM/SILOE 3L**  
K35.207.M30

Pcs 1  
Kg 39,7  
mc 0,414

**HOREB ADAM/SILOE 2+1**  
K35.207.M21

Pcs 1  
Kg 38,8  
mc 0,404

**HOREB ADAM/SILOE 2L**  
K35.207.M20

Pcs 1  
Kg 35,1  
mc 0,342

KARMEL 3000/SILOE  
LARGE SIZE

BULKHEAD  
FLOODLIGHT  
IN-GROUND  
BRICKLIGHT  
BOLLARDS  
GARDEN  
URBAN CLASSIC  
URBAN MODERN  
HIGH-BAY  
POST  
LAMPS

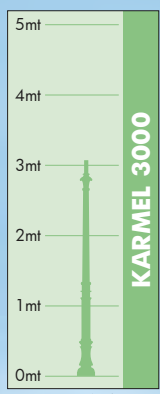



**KARMEL 3000 OFIR/SILOE 2L**  
K35.231.R20

Pcs 1  
Kg 32,2  
mc 0,295

**KARMEL 3000 OFIR/SILOE 3L**  
K35.231.R30

Pcs 1  
Kg 36,5  
mc 0,369

**KARMEL 3000/SILOE**  
K35.231

Pcs 1  
Kg 27  
mc 0,223

**KARMEL 3000 OFIR/SILOE 2L**  
K35.231.R20

Pcs 1  
Kg 32,2  
mc 0,295

**KARMEL 3000 OFIR/SILOE 3L**  
K35.231.R30

Pcs 1  
Kg 36,5  
mc 0,369

KARMEL 3500-4000/**SILOE**  
LARGE SIZE

BULKHEAD  
FLOODLIGHT  
IN-GROUND  
BRICKLIGHT  
BOLLARDS  
GARDEN  
URBAN CLASSIC  
URBAN MODERN  
HIGH-BAY  
POST  
LAMPS

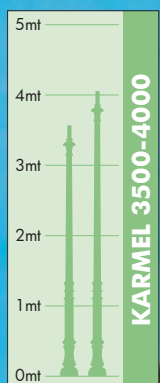
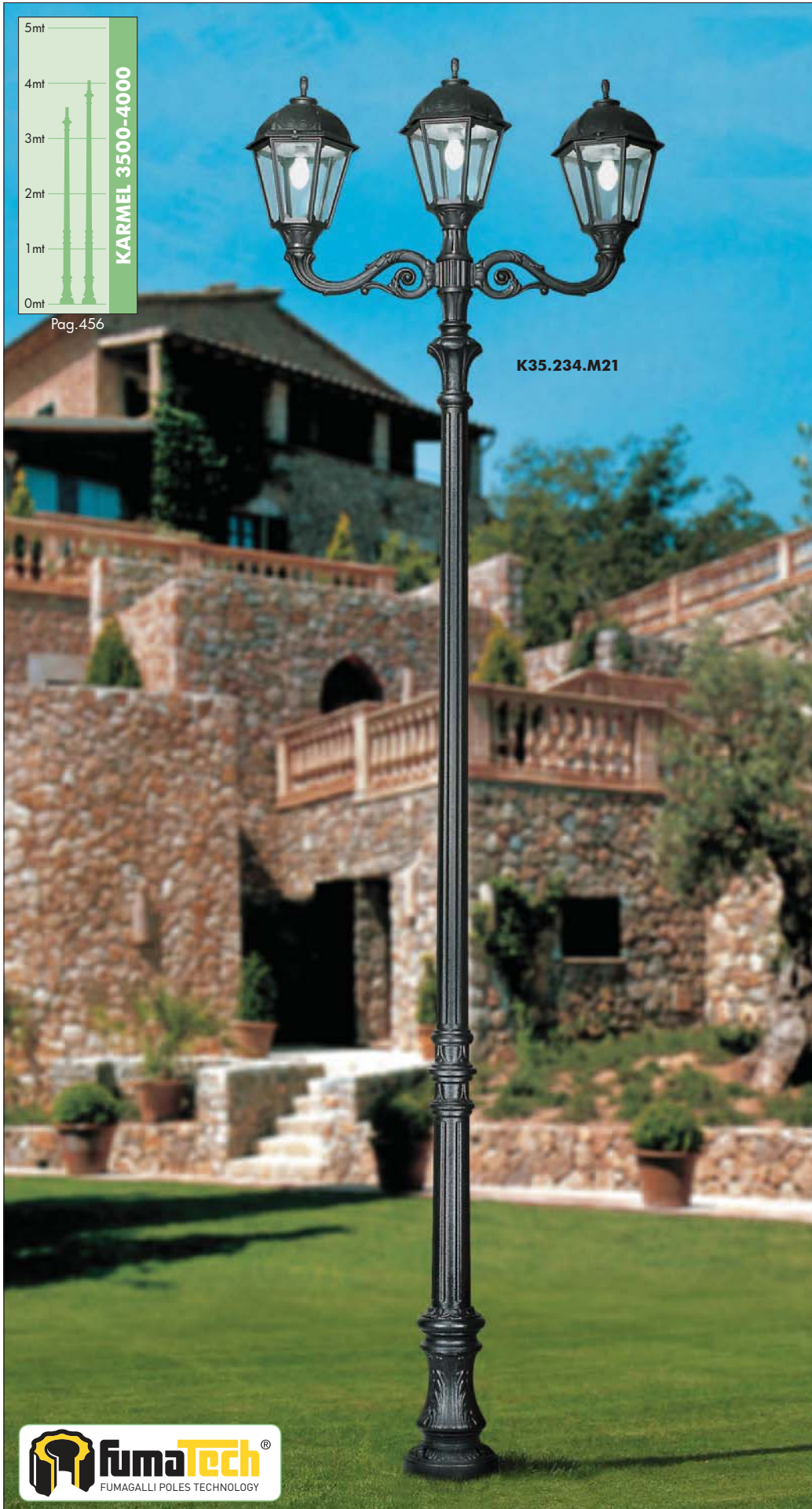

Pag.456

K35.234.M21



K35.171



K35.234

MADE IN ITALY



SABA



SALEM



SILOE

**KARMEL 3500-4000/SILOE**  
**LARGE SIZE**

KARMEL 3500 ADAM/SILOE 1L	KARMEL 4000 ADAM/SILOE 1L
K35.234.M10	K35.237.M10
Pcs 1 Kg 30,4 mc 0,280	Pcs 1 Kg 33,9 mc 0,287

KARMEL 3500 ADAM/SILOE 2+1	KARMEL 4000 ADAM/SILOE 2+1
K35.234.M21	K35.237.M21
Pcs 1 Kg 38,8 mc 0,404	Pcs 1 Kg 42,3 mc 0,431

KARMEL 3500 ADAM/SILOE 3L	KARMEL 4000 ADAM/SILOE 3L
K35.234.M30	K35.237.M30
Pcs 1 Kg 39,7 mc 0,414	Pcs 1 Kg 43,2 mc 0,441

KARMEL 3500/SILOE
K35.234
Pcs 1 Kg 28,5 mc 0,249

KARMEL 3500 ADAM/SILOE 3+1	KARMEL 4000 ADAM/SILOE 3+1
K35.234.M31	K35.237.M31
Pcs 1 Kg 43,4 mc 0,476	Pcs 1 Kg 46,9 mc 0,503

KARMEL 3500 ADAM/SILOE 2L	KARMEL 4000 ADAM/SILOE 2L
K35.234.M20	K35.237.M20
Pcs 1 Kg 35,1 mc 0,342	Pcs 1 Kg 38,7 mc 0,369

BULKHEAD

FLOODLIGHT

IN-GROUND

BRICKLIGHT

BOLLARDS

GARDEN

URBAN CLASSIC

URBAN/MODERN

HIGH-BAY

POST

LAMPS

# TOBIA

## LARGE SIZE

E27 square lantern in classic style, made of shockproof resin material, UV-rays stabilized, rust and corrosion-free. Modular construction suitable for post top, hanging and wall installation. Provided with high temperature resistant ceiling suitable for ballast fixation. Insulation class II, protection rating IP 55.

*Lantern quadra E27 in stile classico, realizzata in resina antiurto, stabilizzata ai raggi UV, inattaccabile da ruggine e corrosione. Idonea per il montaggio a palo, a sospensione o a parete. Fornita con soffitto ad alta resistenza al calore idoneo per il fissaggio dei reattori. Classe di isolamento II, grado di protezione IP55.*



NEW VERSION 2016  
HORIZONTAL BULBS



Q33.000.N2R

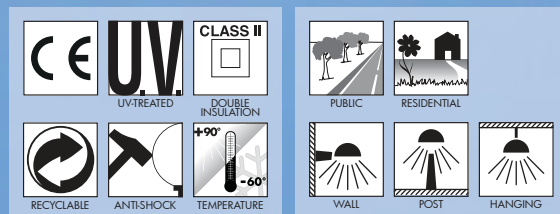

BULKHEAD  
FLOODLIGHT  
IN-GROUND  
BRICKLIGHT  
BOLLARDS  
GARDEN  
URBAN CLASSIC  
URBAN MODERN  
HIGH-BAY  
POST  
LAMPS



**TOBIA - LANTERN COMPONENTS**

IP55



Decorative **PINNACLE** to be mounted on the roof top for post installation or on the lantern base for hanging installation.

**PINNACOLO** decorativo applicabile alla sommità del tetto (montaggio a palo) o sulla base della gabbia (montaggio a sospensione).

Lantern **ROOF** made of shockproof resin material, UV-rays stabilized. Tool-free opening for relamping and access to control-gear.

**TETTO** realizzato in resina antiurto, stabilizzata ai raggi UV. Removibile senza l'ausilio di attrezzi per manutenzione e cambio lampadina.

**DIFFUSER** of UV-rays stabilized polymethylmethacrylate (PMMA), one piece only, with recess for a power supply cable. Available in clear or opal colour. For the version MBF 125W and HQI/SON 100W the enclosure is open at the bottom, enabling a correct disposal of the heat inside the diffuser.

**DIFFUSORE** in polimetilmetacrilato (PMMA) resistente all'ingiallimento ed ai raggi UV, disponibile in colore trasparente o opale, realizzato in unico pezzo, provvisto di sede per alloggiamento del cavo di alimentazione. Per la versione MBF 125W o HQI/SON 100W il diffusore è aperto alla base per un corretto smaltimento del calore nel vano ottico.

**CAGE** made of shockproof resin material, UV-rays stabilized, rust and corrosion-free.

**GABBIA** realizzata in resina antiurto, stabilizzata ai raggi UV, inattaccabile da ruggine e corrosione.

**TOBIA**

Q33.000 \*

open diffuser Q34.000\*



**Dimensions and weight**

Height: 520 mm  
Width: 330 mm  
Depth: 330 mm  
Weight: 3,5 Kg  
Junction to support: diameter 60 mm  
Area exposed to wind pressure: CxS = m<sup>2</sup> 0,089

**Moulded colours:**

Black White

**Painted colours:**

Antique green Antique bronze

**Diffuser PMMA:**

Clear Opal

**2x E27**



Lantern supplied with white resin ceiling complete with **2x E27** lampholders. Provided as an option with TÜV approved, long-life and efficient **LED filament lamps suitable for outdoor use**. Version with daylight and motion sensor available.

		max 160 mm		*ADD. SUFFIX
2x E27 (CFL-LED)		←→		.E28
2x E27 + SENSOR		←→		.ES8
2 FILAMENT LED LAMPS	2x 8 W 16W	2000 Lm	2700 K	.M2R
	2x 12 W 24W	3000 Lm	2700 K	.N2R

**E27**



Lantern supplied with high temperature resistant CEILING made of white polycarbonate (PC), complete with **E27** lampholder. Provided as an option with TÜV approved, long-life and efficient **LED filament lamps suitable for outdoor use**.

		E27 lampholder only		*ADD. SUFFIX
E27 (GLS-CFL-LED)				.E27
FILAMENT LED LAMP	8W	1000 Lm	2700 K	.M1R
FILAMENT LED LAMP	12W	1500 Lm	2700 K	.N1R

**E27-E40 with BALLAST KIT**



Lantern supplied with high temperature resistant CEILING made of white polycarbonate (PC), complete with E27-E40 lampholder and with **ballast kit** for SON-HQI lamps.

				*ADD. SUFFIX
CLOSED DIFFUSER IP55	E27 WITH BALLAST KIT	SON 70W		.S70
		HQI 70W		.H70
OPEN DIFFUSER	E40 WITH BALLAST KIT	SON 100W		.S10
		HQI 100W		.H10

**PHOTOMETRIC DATA SAMPLE**

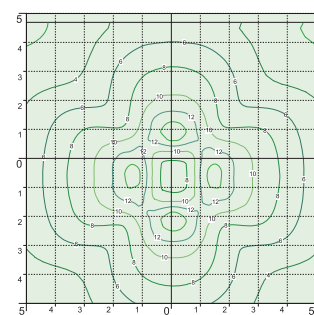
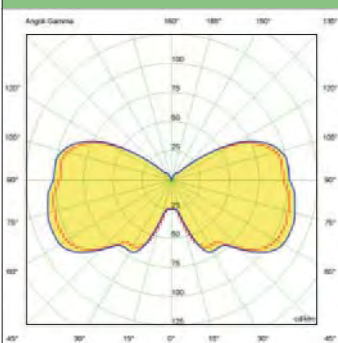

**TOBIA lantern clear SON 100W.**

POST height 3.5mt  
10 x 10mt area: average 15 lux

The photometric data for all the versions are available upon request or on our website.

\* ADD THESE SUFFIXES TO THE REFERENCES MENTIONED IN THE CATALOGUE

**LED LAMPS**



More technical details about TÜV approved Fumagalli LED Lamps on page 468.



# TOBIA LED

## LARGE SIZE

BULKHEAD

FLOODLIGHT

IN-GROUND

BRICKLIGHT

BOLLARDS

GARDEN

URBAN CLASSIC

URBAN MODERN

HIGH-BAY

POST

LAMPS

Square lantern in classic style, made of shockproof resin material, UV-rays stabilized, rust and corrosion-free. Modular construction suitable for post top, hanging and wall installation. Supplied as standard with **FLAT diffuser** and equipped with long-life, powerful and efficient TÜV approved GX53 LED modular system in different wattages. Designed according to the international regulations against light pollution (standard UNI 10819). Insulation class II, Protection rating IP 65.

*Lantern a quadrato in stile classico, realizzata in resina antiurto, stabilizzata ai raggi UV, inattaccabile da ruggine e corrosione. Idonea per il montaggio a palo, a sospensione o a parete. Fornita con **diffusore piatto** ed equipaggiata con sistema modulare a LED GX53 approvato TÜV di lunga durata ed alta efficienza disponibile in diverse potenze. Progettato in ottemperanza alle norme internazionali contro l'inquinamento luminoso (standard UNI 10819). Classe di isolamento II, grado di protezione IP65.*



Q35.000.D4L



**TOBIA LED - LANTERN COMPONENTS**

**IP65**



Decorative **PINNACLE** to be mounted on the roof top for post installation or on the lantern base for hanging installation.

**PINNACOLO** decorativo applicabile alla sommità del tetto (montaggio a palo) o sulla base della gabbia (montaggio a sospensione).

**LANTERN ROOF** made of shockproof resin material, UV-rays stabilized. Tool-free opening for relamping and maintenance.

**TETTO** realizzato in resina antiurto, stabilizzata ai raggi UV. Rimovibile senza l'ausilio di attrezzi per manutenzione e cambio lampadina.

**DIFFUSER** with flat shape made of UV-rays stabilized polymethylmethacrylate (PMMA), provided with silicone rubber gasket to ensure an increased protection against external agent. Version with full diffuser available upon request.

**DIFFUSORE** in polimetilmetacrilato (PMMA) con configurazione piatta, provvisto di guarnizione in gomma siliconica per garantire una migliore protezione contro gli agenti esterni. Disponibile su richiesta anche versione con diffusore pieno.

**CAGE** made of shockproof resin material, UV-rays stabilized, rust and corrosion-free.

**GABBIA** realizzata in resina antiurto, stabilizzata ai raggi UV, inattaccabile da ruggine e corrosione.

**TOBIA LED**

Q35.000 \*



**Dimensions and weight**

Height: 520 mm  
Width: 330 mm  
Depth: 330 mm  
Weight: 4,3 Kg  
Junction to support: diameter 60 mm  
Area exposed to wind pressure: CxS = m<sup>2</sup> 0,089

**Moulded colours:**

Black  White

**Painted colours:**

Antique green  Antique bronze

**Diffuser PMMA:**

Clear  Opal

**GX53 LED**



- **COST SAVING:** long-life and efficient LED light sources.
- **BUILT-IN DRIVER:** quick and easy lamp replacement
- **GREAT FLEXIBILITY:** GX53 standard lamp holder.
- **FUTURE-PROOFED LUMINARIES:** performances easy to upgrade to latest technology developments.
- **SUITABLE FOR OUTDOOR USE:** built-in driver fully protected against heat and humidity by silicone paste.

\*ADD SUFFIX

Lantern supplied with white resin CEILING provided with TÜV approved, long-life and efficient 4x GX53 LED lamps included. Each lamp can be quickly and easily replaced individually, making the luminaries maintenance very simple.



4x 7 W  
**28 W**

**3200 Lm**

4000 K .C4L

3000 K .C4R

4x 10 W  
**40 W**

**4800 Lm**

4000 K .D4L

3000 K .D4R

\* ADD THESE SUFFIXES TO THE REFERENCES MENTIONED IN THE CATALOGUE

**LED LAMPS**



More technical details about TÜV approved Fumagalli LED Lamps on page 468.

**PHOTOMETRIC DATA SAMPLE**

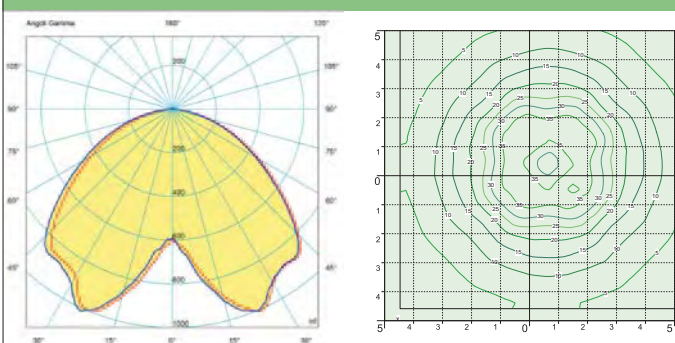

**TOBIA LED**



4x7W GX53 LED  
**28W**  
(power consumption)

Area: 10x10mt  
Height: 3.5mt  
**15 lux**

**SAVE -72%**



**TOBIA E40**

(OPEN DIFFUSER)

HQI - SON  
**100W**  
(power consumption)

Area: 10x10mt  
Height: 3.5mt  
**15 lux**

**TOBIA**  
LARGE SIZE

BULKHEAD

FLOODLIGHT

IN-GROUND

BRICKLIGHT

BOLLARDS

GARDEN

URBAN CLASSIC

URBAN MODERN

HIGH-BAY

POST

LAMPS

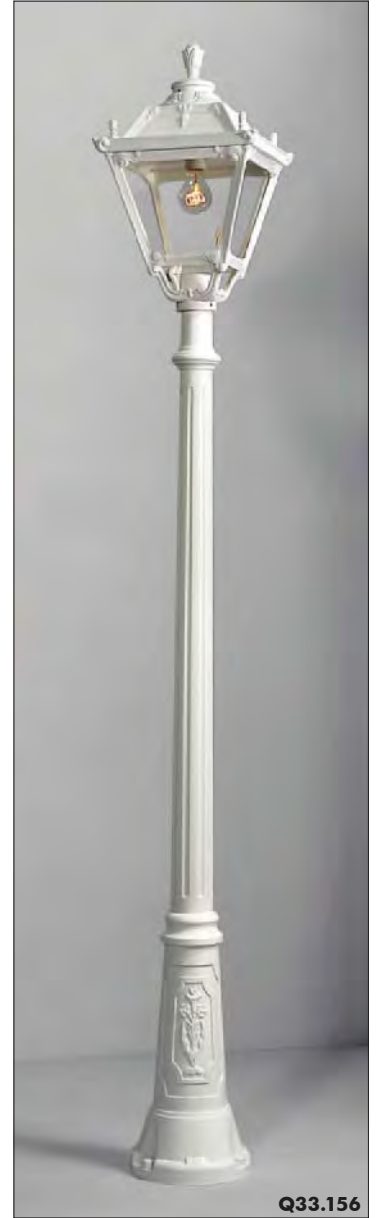

MADE IN ITALY



**OFIR/TOBIA**

**E27** Q33.132  
**LED** Q35.132

Pcs 1  
Kg 5,4  
mc 0,061

**EVA/TOBIA**

**E27** Q33.181  
**LED** Q35.181

Pcs 1  
Kg 13  
mc 0,168

**TOBIA**

**E27** Q33.000  
**LED** Q35.000

Pcs 1  
Kg 3,5  
mc 0,043

**LOT/TOBIA**

**E27** Q33.113  
**LED** Q35.113

Pcs 1  
Kg 5,4  
mc 0,061

**MIRRA/TOBIA**

**E27** Q33.142  
**LED** Q35.142

Pcs 1  
Kg 13  
mc 0,083

**SICHEM/TOBIA**

**E27** Q33.121  
**LED** Q35.121

Pcs 1  
Kg 5,4  
mc 0,061

**RICU/TOBIA**

**E27** Q33.157  
**LED** Q35.157

Pcs 2  
Kg 27,2  
mc 0,334

**GIGI/TOBIA**

**E27** Q33.156  
**LED** Q35.156

Pcs 2  
Kg 26,2  
mc 0,304

**ARTU'/TOBIA**

**E27** Q33.158  
**LED** Q35.158

Pcs 2  
Kg 22,8  
mc 0,273

**ALOE'/TOBIA**

**E27** Q33.163 resin  
**LED** Q35.163 resin

Pcs 2  
Kg 13,2  
mc 0,208

**IAFET.R/TOBIA**

**E27** Q33.162 resin  
**LED** Q35.162 resin

Pcs 2  
Kg 13,1  
mc 0,179

NEBO/TOBIA  
LARGE SIZE

BULKHEAD

FLOODLIGHT

IN-GROUND

BRICKLIGHT

BOLLARDS

GARDEN

URBAN CLASSIC

URBAN MODERN

HIGH-BAY

POST

LAMPS

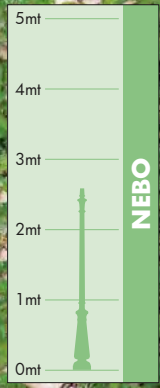

MADE IN ITALY



**NEBO OFIR/TOBIA 2L**

**E27** Q33.201.R20  
**LED** Q35.201.R20

Pcs 1  
Kg 26,9  
mc 0,268

**NEBO OFIR/TOBIA 3L**

**E27** Q33.201.R30  
**LED** Q35.201.R30

Pcs 1  
Kg 29,4  
mc 0,342

**NEBO/TOBIA**

**E27** Q33.201  
**LED** Q35.201

Pcs 1  
Kg 21,7  
mc 0,196

**NEBO OFIR/TOBIA 2L**

**E27** Q33.201.R20  
**LED** Q35.201.R20

Pcs 1  
Kg 26,9  
mc 0,268

**NEBO OFIR/TOBIA 3L**

**E27** Q33.201.R30  
**LED** Q35.201.R30

Pcs 1  
Kg 29,4  
mc 0,342

TABOR/TOBIA  
LARGE SIZE

BULKHEAD  
FLOODLIGHT  
IN-GROUND  
BRICKLIGHT  
BOLLARDS  
GARDEN  
URBAN CLASSIC  
URBAN MODERN  
HIGH-BAY  
POST  
LAMPS



MADE IN ITALY



**TABOR OFIR/TOBIA 2L**

**E27** Q33.204.R20  
**LED** Q35.204.R20

Pcs 1  
Kg 32,2  
mc 0,295

850

3130

2

**TABOR OFIR/TOBIA 3L**

**E27** Q33.204.R30  
**LED** Q35.204.R30

Pcs 1  
Kg 34,6  
mc 0,369

890

3130

3

**TABOR/TOBIA**

**E27** Q33.204  
**LED** Q35.204

Pcs 1  
Kg 27  
mc 0,223

330

3460

Ø 275

**TABOR OFIR/TOBIA 2L**

**E27** Q33.204.R20  
**LED** Q35.204.R20

Pcs 1  
Kg 32,2  
mc 0,295

850

3560

2

Ø 275

**TABOR OFIR/TOBIA 3L**

**E27** Q33.204.R30  
**LED** Q35.204.R30

Pcs 1  
Kg 34,6  
mc 0,369

890

3560

3

Ø 275



HOREB/TOBIA  
LARGE SIZE

BULKHEAD  
FLOODLIGHT  
IN-GROUND  
BRICKLIGHT  
BOLLARDS  
GARDEN  
URBAN CLASSIC  
URBAN MODERN  
HIGH-BAY  
POST  
LAMPS

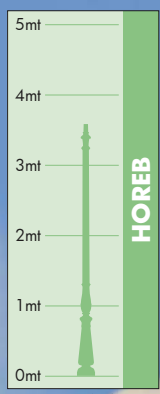



**HOREB ADAM/TOBIA 1L**

**E27** Q33.207.M10  
**LED** Q35.207.M10

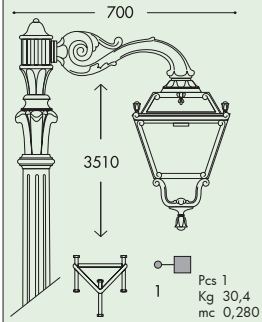

**ADAM/TOBIA**

**E27** Q33.171  
**LED** Q35.171

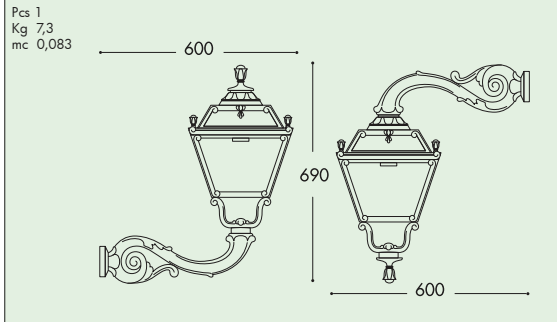

**HOREB ADAM/TOBIA 2+1**

**E27** Q33.207.M21  
**LED** Q35.207.M21

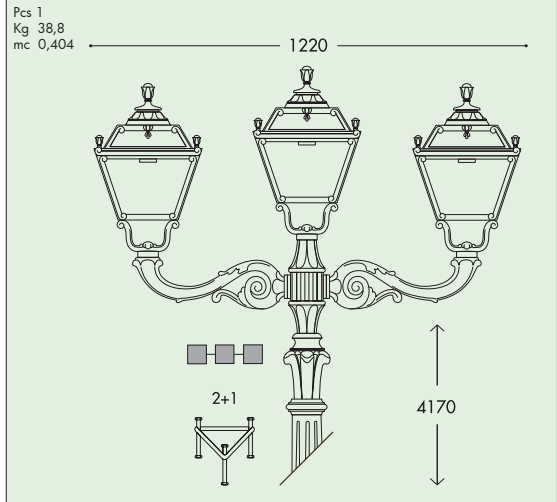

**HOREB/TOBIA**

**E27** Q33.207  
**LED** Q35.207

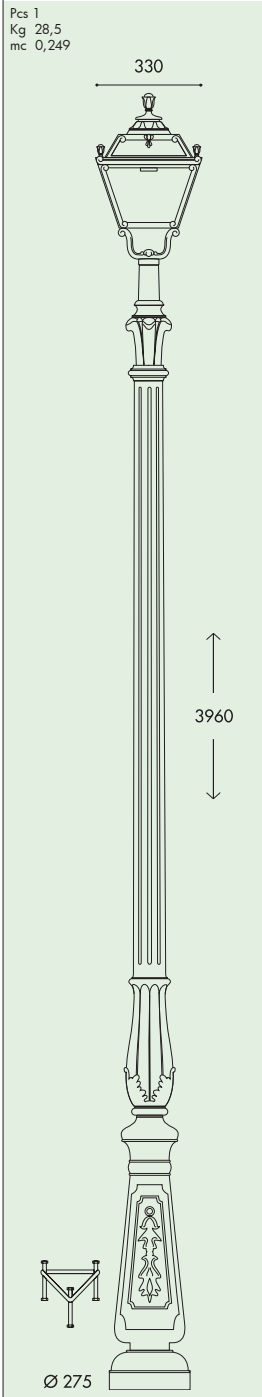

**HOREB ADAM/TOBIA 3+1**

**E27** Q33.207.M31  
**LED** Q35.207.M31

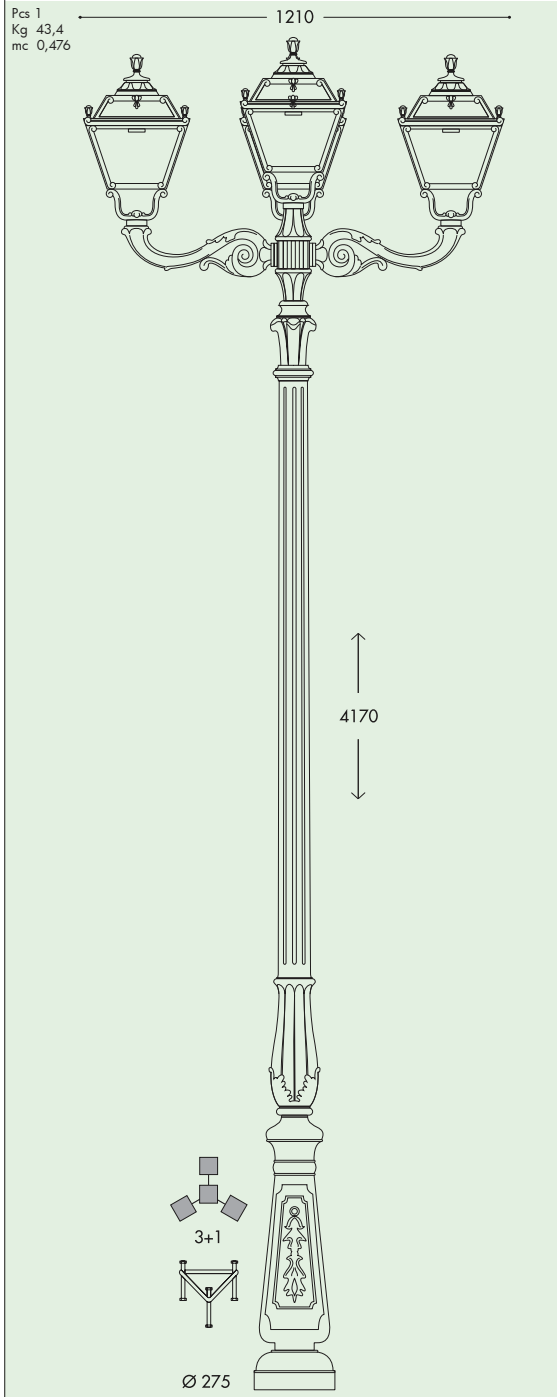

**HOREB ADAM/TOBIA 3L**

**E27** Q33.207.M30  
**LED** Q35.207.M30

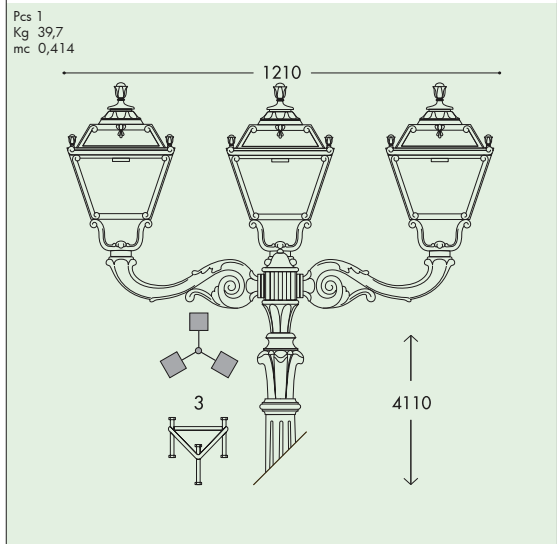

**HOREB ADAM/TOBIA 2L**

**E27** Q33.207.M20  
**LED** Q35.207.M20

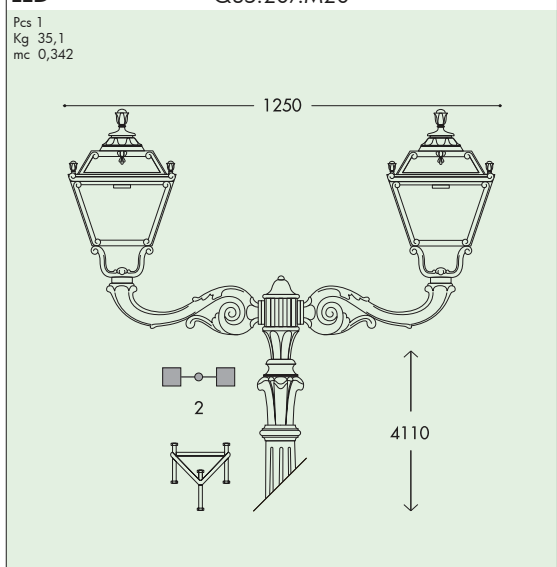

BULKHEAD  
FLOODLIGHT  
IN-GROUND  
BRICKLIGHT  
BOLLARDS  
GARDEN  
URBAN CLASSIC  
URBAN/MODERN  
HIGH-BAY  
POST  
LAMPS

KARMEL 3000/**TOBIA**  
LARGE SIZE

BULKHEAD  
FLOODLIGHT  
IN-GROUND  
BRICKLIGHT  
BOLLARDS  
GARDEN  
URBAN CLASSIC  
URBAN MODERN  
HIGH-BAY  
POST  
LAMPS

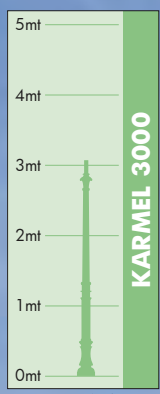

MADE IN ITALY



**KARMEL 3000 OFIR/TOBIA 2L**

**E27** Q33.231.R20  
**LED** Q35.231.R20

Pcs 1  
Kg 32,2  
mc 0,295

**KARMEL 3000 OFIR/TOBIA 3L**

**E27** Q33.231.R30  
**LED** Q35.231.R30

Pcs 1  
Kg 34,6  
mc 0,369

**KARMEL 3000/TOBIA**

**E27** Q33.231  
**LED** Q35.231

Pcs 1  
Kg 27  
mc 0,223

**KARMEL 3000 OFIR/TOBIA 2L**

**E27** Q33.231.R20  
**LED** Q35.231.R20

Pcs 1  
Kg 32,2  
mc 0,295

**KARMEL 3000 OFIR/TOBIA 3L**

**E27** Q33.231.R30  
**LED** Q35.231.R30

Pcs 1  
Kg 34,6  
mc 0,369

KARMEL 3500-4000/**TOBIA**  
LARGE SIZE

BULKHEAD  
FLOODLIGHT  
IN-GROUND  
BRICKLIGHT  
BOLLARDS  
GARDEN  
URBAN CLASSIC  
URBAN MODERN  
HIGH-BAY  
POST  
LAMPS





KARMEL 3500 ADAM/TOBIA 1L	KARMEL 4000 ADAM/TOBIA 1L
<b>E27</b> Q33.234.M10	Q33.237.M10
<b>LED</b> Q35.234.M10	Q35.237.M10
Pcs 1 Kg 30,4 mc 0,280	Pcs 1 Kg 33,9 mc 0,287

KARMEL 3500 ADAM/TOBIA 2+1	KARMEL 4000 ADAM/TOBIA 2+1
<b>E27</b> Q33.234.M21	<b>E27</b> Q33.237.M21
<b>LED</b> Q35.234.M21	<b>LED</b> Q35.237.M21
Pcs 1 Kg 38,8 mc 0,404	Pcs 1 Kg 42,3 mc 0,431

KARMEL 3500 ADAM/TOBIA 3L	KARMEL 4000 ADAM/TOBIA 3L
<b>E27</b> Q33.234.M30	<b>E27</b> Q33.237.M30
<b>LED</b> Q35.234.M30	<b>LED</b> Q35.237.M30
Pcs 1 Kg 39,7 mc 0,414	Pcs 1 Kg 43,2 mc 0,441

KARMEL 3500/TOBIA	
<b>E27</b> Q33.234	
<b>LED</b> Q35.234	
Pcs 1 Kg 28,5 mc 0,249	

KARMEL 3500/TOBIA	
<b>E27</b> Q33.234	
<b>LED</b> Q35.234	
Pcs 1 Kg 28,5 mc 0,249	

KARMEL 3500 ADAM/TOBIA 3+1	KARMEL 4000 ADAM/TOBIA 3+1
<b>E27</b> Q33.234.M31	<b>E27</b> Q33.237.M31
<b>LED</b> Q35.234.M31	<b>LED</b> Q35.237.M31
Pcs 1 Kg 43,4 mc 0,476	Pcs 1 Kg 46,9 mc 0,503

KARMEL 3500 ADAM/TOBIA 2L	KARMEL 4000 ADAM/TOBIA 2L
<b>E27</b> Q33.234.M20	<b>E27</b> Q33.237.M20
<b>LED</b> Q35.234.M20	<b>LED</b> Q35.237.M20
Pcs 1 Kg 35,1 mc 0,342	Pcs 1 Kg 38,7 mc 0,369

BULKHEAD  
FLOODLIGHT  
IN-GROUND  
BRICKLIGHT  
BOLLARDS  
GARDEN  
URBAN CLASSIC  
URBAN/MODERN  
HIGH-BAY  
POST  
LAMPS

# SIMON

## LARGE SIZE

E27 square lantern in classic style, made of shockproof resin material, UV-rays stabilized, rust and corrosion-free. Modular construction suitable for post top, hanging and wall installation. Provided with high temperature resistant ceiling suitable for ballast fixation. Insulation class II, protection rating IP 55.

*Lanterna quadra E27 in stile classico, realizzata in resina antiurto, stabilizzata ai raggi UV, inattaccabile da ruggine e corrosione. Idonea per il montaggio a palo, a sospensione o a parete. Fornita con soffitto ad alta resistenza al calore idoneo per il fissaggio dei reattori. Classe di isolamento II, grado di protezione IP55.*



U33.132

NEW VERSION 2016  
HORIZONTAL BULBS



MADE IN ITALY

BULKHEAD  
FLOODLIGHT  
IN-GROUND  
BRICKLIGHT  
BOLLARDS  
GARDEN  
URBAN CLASSIC  
URBAN MODERN  
HIGH-BAY  
POST  
LAMPS

**SIMON - LANTERN COMPONENTS**

IP55



Decorative **PINNACLE** to be mounted on the roof top for post installation or on the lantern base for hanging installation.

**PINNACOLO** decorativo applicabile alla sommità del tetto (montaggio a palo) o sulla base della gabbia (montaggio a sospensione).

Lantern **ROOF** made of shockproof resin material, UV-rays stabilized. Tool-free opening for relamping and access to control-gear.

**TETTO** realizzato in resina antiurto, stabilizzata ai raggi UV. Rimovibile senza l'ausilio di attrezzi per manutenzione e cambio lampadina.

**DIFFUSER** of UV-rays stabilized polymethylmethacrylate (PMMA), one piece only, with recess for a power supply cable. Available in clear or opal colour. For the version MBF 125W and HQI/SON 100W the enclosure is open at the bottom, enabling a correct disposal of the heat inside the diffuser.

**DIFFUSORE** in polimetilmetacrilato, resistente all'ingiallimento ed ai raggi UV, disponibile in colore trasparente o opale, realizzato in unico pezzo, provvisto di sede per alloggiamento del cavo di alimentazione. Per la versione MBF 125W o HQI/SON 100W il diffusore è aperto alla base per un corretto smaltimento del calore nel vano ottico.

**CAGE** made of shockproof resin material, UV-rays stabilized, rust and corrosion-free.

**GABBIA** realizzata in resina antiurto, stabilizzata ai raggi UV, inattaccabile da ruggine e corrosione.

**SIMON**

U33.000 \*

open diffuser U34.000\*



**Dimensions and weight**

Height: 560 mm  
Width: 330 mm  
Depth: 330 mm  
Weight: 3,5 Kg  
Junction to support: diameter 60 mm  
Area exposed to wind pressure: CxS = m<sup>2</sup> 0,102

**Moulded colours:**

Black White

**Painted colours:**

Antique green Antique bronze

**Diffuser PMMA:**

Clear Opal

**2x E27**

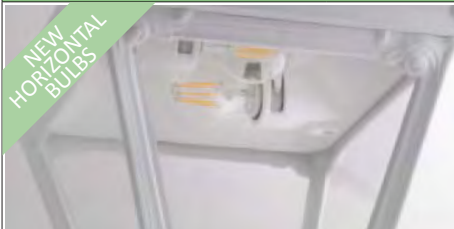

Lantern supplied with white resin ceiling complete with **2x E27** lampholders. Provided as an option with TÜV approved, long-life and efficient **LED filament lamps suitable for outdoor use**. Version with daylight and motion sensor available.

		max 160 mm		*ADD. SUFFIX
2x E27 (CFL-LED)		←→		.E28
2x E27 + SENSOR		←→		.ES8
2 FILAMENT LED LAMPS	2x 8 W 16W	2000 Lm	2700 K	.M2R
	2x 12 W 24W	3000 Lm	2700 K	.N2R

**E27**



Lantern supplied with high temperature resistant CEILING made of white polycarbonate (PC), complete with **E27** lampholder. Provided as an option with TÜV approved, long-life and efficient **LED filament lamps suitable for outdoor use**.

		max 160 mm		*ADD. SUFFIX
E27 (GLS-CFL-LED)	E27 lampholder only			.E27
FILAMENT LED LAMP	8W	1000 Lm	2700 K	.M1R
FILAMENT LED LAMP	12W	1500 Lm	2700 K	.N1R

**E27-E40 with BALLAST KIT**



Lantern supplied with high temperature resistant CEILING made of white polycarbonate (PC), complete with E27-E40 lampholder and with **ballast kit** for SON-HQI lamps.

		max 160 mm		*ADD. SUFFIX
CLOSED DIFFUSER IP55	E27 WITH BALLAST KIT	SON 70W		.S70
		HQI 70W		.H70
OPEN DIFFUSER	E40 WITH BALLAST KIT	SON 100W		.S10
		HQI 100W		.H10

**PHOTOMETRIC DATA SAMPLE**

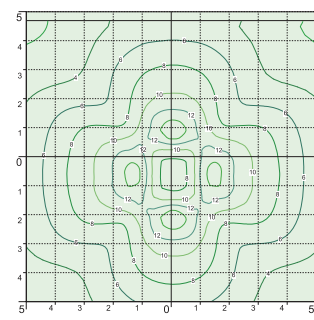
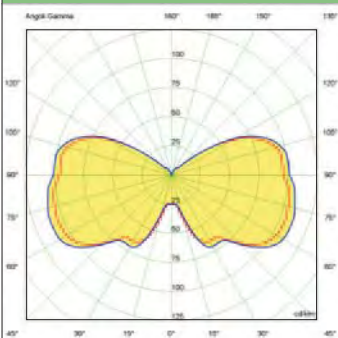

**SIMON lantern clear SON 100W.**

POST height 3.5mt  
10 x 10mt area: average 15 lux

The photometric data for all the versions are available upon request or on our website.

\* ADD THESE SUFFIXES TO THE REFERENCES MENTIONED IN THE CATALOGUE

**LED LAMPS**



More technical details about TÜV approved Fumagalli LED Lamps on page 468.



# SIMON LED

## LARGE SIZE

Square lantern in classic style, made of shockproof resin material, UV-rays stabilized, rust and corrosion-free. Modular construction suitable for post top, hanging and wall installation. Supplied as standard with **FLAT diffuser** and equipped with long-life, powerful and efficient TÜV approved GX53 LED modular system in different wattages. Designed according to the international regulations against light pollution (standard UNI 10819). Insulation class II, Protection rating IP 65.

*Lanterna quadra in stile classico, realizzata in resina antiurto, stabilizzata ai raggi UV, inattaccabile da ruggine e corrosione. Idonea per il montaggio a palo, a sospensione o a parete. Fornita con **diffusore piatto** ed equipaggiata con sistema modulare a LED GX53 approvato TÜV di lunga durata ed alta efficienza disponibile in diverse potenze. Progettato in ottemperanza alle norme internazionali contro l'inquinamento luminoso (standard UNI 10819). Classe di isolamento II, grado di protezione IP65.*



U35.132.D4L





**SIMON LED - LANTERN COMPONENTS**

IP65



Decorative **PINNACLE** to be mounted on the roof top for post installation or on the lantern base for hanging installation.

**PINNACOLO** decorativo applicabile alla sommità del tetto (montaggio a palo) o sulla base della gabbia (montaggio a sospensione).

**LANTERN ROOF** made of shockproof resin material, UV-rays stabilized. Tool-free opening for relamping and maintenance.

**TETTO** realizzato in resina antiurto, stabilizzata ai raggi UV. Rimovibile senza l'ausilio di attrezzi per manutenzione e cambio lampadina.

**DIFFUSER** with flat shape made of UV-rays stabilized polymethylmethacrylate (PMMA), provided with silicone rubber gasket to ensure an increased protection against external agent. Version with full diffuser available upon request.

**DIFFUSORE** in polimetilmetacrilato (PMMA) con configurazione piatta, provvisto di guarnizione in gomma siliconica per garantire una migliore protezione contro gli agenti esterni. Disponibile su richiesta anche versione con diffusore pieno.

**CAGE** made of shockproof resin material, UV-rays stabilized, rust and corrosion-free.

**GABBIA** realizzata in resina antiurto, stabilizzata ai raggi UV, inattaccabile da ruggine e corrosione.

**SIMON LED**

U35.000 \*



**Dimensions and weight**

Height: 560 mm  
Width: 330 mm  
Depth: 330 mm  
Weight: 4,3 Kg  
Junction to support: diameter 60 mm  
Area exposed to wind pressure:  
CxS = m<sup>2</sup> 0,102

**Moulded colours:**

Black White

**Painted colours:**

Antique green Antique bronze

**Diffuser PMMA:**

Clear Opal

**GX53 LED**



- **COST SAVING:** long-life and efficient LED light sources.
- **BUILT-IN DRIVER:** quick and easy lamp replacement
- **GREAT FLEXIBILITY:** GX53 standard lamp holder.
- **FUTURE-PROOFED LUMINARIES:** performances easy to upgrade to latest technology developments.
- **SUITABLE FOR OUTDOOR USE:** built-in driver fully protected against heat and humidity by silicone paste.

\*ADD SUFFIX

Lantern supplied with white resin CEILING provided with TÜV approved, long-life and efficient 4x GX53 LED lamps included. Each lamp can be quickly and easily replaced individually, making the luminaries maintenance very simple.



4x 7 W  
**28 W**

**3200 Lm**

4000 K .C4L

3000 K .C4R

4x 10 W  
**40 W**

**4800 Lm**

4000 K .D4L

3000 K .D4R

\* ADD THESE SUFFIXES TO THE REFERENCES MENTIONED IN THE CATALOGUE

**PHOTOMETRIC DATA SAMPLE**

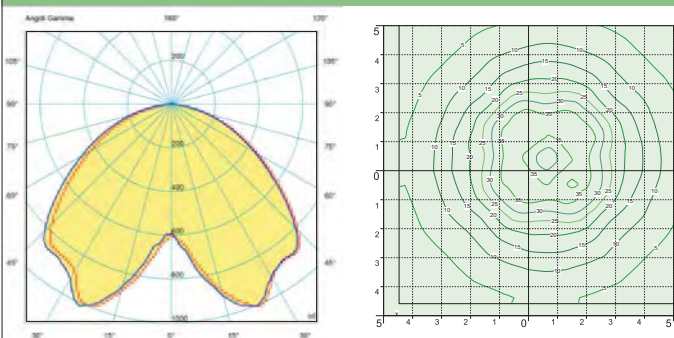

**SIMON LED**



SAVE  
**-72%**

4x7W GX53 LED  
**28W**  
(power consumption)

Area: 10x10mt  
Height: 3.5mt  
**15 lux**

**SIMON E27**

(OPEN DIFFUSER)



HQI - SON  
**100W**  
(power consumption)

Area: 10x10mt  
Height: 3.5mt  
**15 lux**

**SIMON**  
LARGE SIZE

BULKHEAD  
FLOODLIGHT  
IN-GROUND  
BRICKLIGHT  
BOLLARDS  
GARDEN  
URBAN CLASSIC  
URBAN MODERN  
HIGH-BAY  
POST  
LAMPS



MADE IN ITALY



**OFIR/SIMON**

**E27** U33.132  
**LED** U35.132

Pcs 1  
Kg 4,4  
mc 0,061

**EVA/SIMON**

**E27** U33.181  
**LED** U35.181

Pcs 1  
Kg 13  
mc 0,168

**SIMON**

**E27** U33.000  
**LED** U35.000

Pcs 1  
Kg 3,5  
mc 0,043

**LOT/SIMON**

**E27** U33.113  
**LED** U35.113

Pcs 1  
Kg 4,4  
mc 0,061

**MIRRA/SIMON**

**E27** U33.142  
**LED** U35.142

Pcs 1  
Kg 11  
mc 0,083

**SICHEM/SIMON**

**E27** U33.121  
**LED** U35.121

Pcs 1  
Kg 4,4  
mc 0,061

**RICU/SIMON**

**E27** U33.157  
**LED** U35.157

Pcs 2  
Kg 27,2  
mc 0,334

**GIGI/SIMON**

**E27** U33.156  
**LED** U35.156

Pcs 2  
Kg 26,2  
mc 0,304

**ARTU'/SIMON**

**E27** U33.158  
**LED** U35.158

Pcs 2  
Kg 22,8  
mc 0,273

**ALOE'/SIMON**

**E27** U33.163 resin  
**LED** U35.163 resin

Pcs 2  
Kg 13,2  
mc 0,208

**IAFET.R/SIMON**

**E27** U33.162 resin  
**LED** U35.162 resin

Pcs 2  
Kg 13,1  
mc 0,179

NEBO/SIMON  
LARGE SIZE

BULKHEAD

FLOODLIGHT

IN-GROUND

BRICKLIGHT

BOLLARDS

GARDEN

URBAN CLASSIC

URBAN MODERN

HIGH-BAY

POST

LAMPS

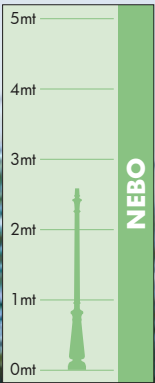

Pag.456



MADE IN ITALY



**NEBO OFIR/SIMON 2L**

**E27** U33.201.R20  
**LED** U35.201.R20

Pcs 1  
Kg 26,9  
mc 0,268

850

2630

2

**NEBO OFIR/SIMON 3L**

**E27** U33.201.R30  
**LED** U35.201.R30

Pcs 1  
Kg 29,4  
mc 0,342

890

2630

3

**NEBO/SIMON**

**E27** U33.201  
**LED** U35.201

Pcs 1  
Kg 21,7  
mc 0,196

330

3000

2

Ø 275

**NEBO OFIR/SIMON 2L**

**E27** U33.201.R20  
**LED** U35.201.R20

Pcs 1  
Kg 26,9  
mc 0,268

850

3100

2

Ø 275

**NEBO OFIR/SIMON 3L**

**E27** U33.201.R30  
**LED** U35.201.R30

Pcs 1  
Kg 29,4  
mc 0,342

850

3100

3

Ø 275

TABOR/SIMON  
LARGE SIZE

BULKHEAD  
FLOODLIGHT  
IN-GROUND  
BRICKLIGHT  
BOLLARDS  
GARDEN  
URBAN CLASSIC  
URBAN MODERN  
HIGH-BAY  
POST  
LAMPS

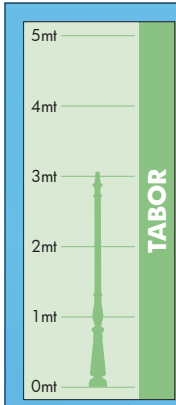

MADE IN ITALY



**TABOR OFIR/SIMON 2L**

**E27** U33.204.R20  
**LED** U35.204.R20

Pcs 1  
Kg 26,9  
mc 0,268

850

3130

2

**TABOR OFIR/SIMON 3L**

**E27** U33.204.R30  
**LED** U35.204.R30

Pcs 1  
Kg 29,4  
mc 0,342

890

3130

3

**TABOR/SIMON**

**E27** U33.204  
**LED** U35.204

Pcs 1  
Kg 21,7  
mc 0,196

330

3500

1

Ø 275

**TABOR OFIR/SIMON 2L**

**E27** U33.204.R20  
**LED** U35.204.R20

Pcs 1  
Kg 26,9  
mc 0,268

850

3600

2

Ø 275

**TABOR OFIR/SIMON 3L**

**E27** U33.204.R30  
**LED** U35.204.R30

Pcs 1  
Kg 29,4  
mc 0,342

890

3600

3

Ø 275



BULKHEAD

FLOODLIGHT

IN-GROUND

BRICKLIGHT

BOLLARDS

GARDEN

URBAN CLASSIC

URBAN MODERN

HIGH-BAY

POST

LAMPS





**HOREB ADAM/SIMON 1L**

**E27** U33.207.M10  
**LED** U35.207.M10

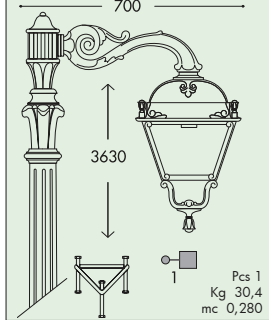

**ADAM/SIMON**

**E27** U33.171  
**LED** U35.171

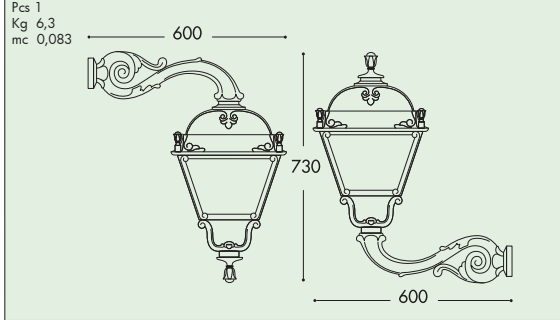

**HOREB/SIMON**

**E27** U33.207  
**LED** U35.207

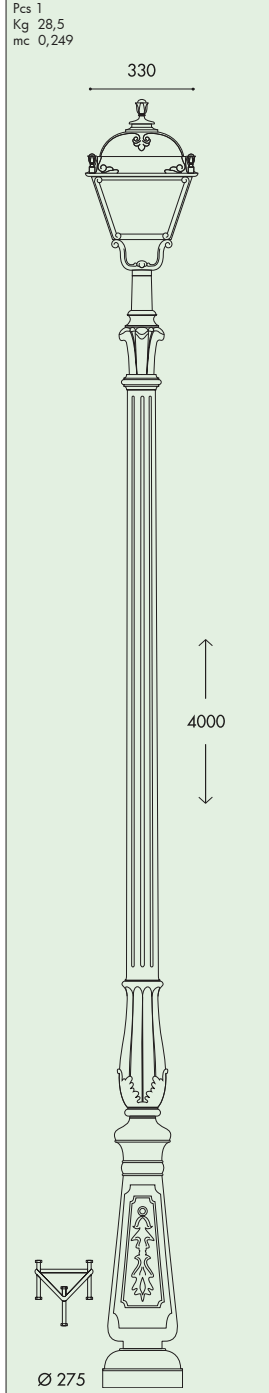

**HOREB ADAM/SIMON 3+1**

**E27** U33.207.M31  
**LED** U35.207.M31

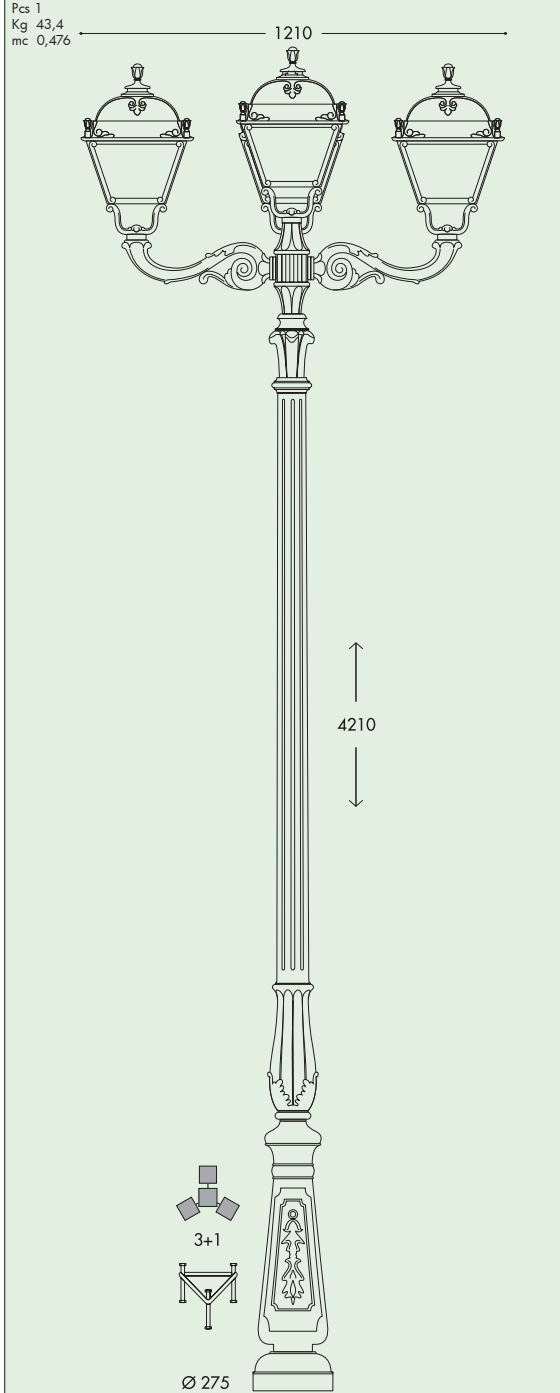

**HOREB ADAM/SIMON 2+1**

**E27** U33.207.M21  
**LED** U35.207.M21

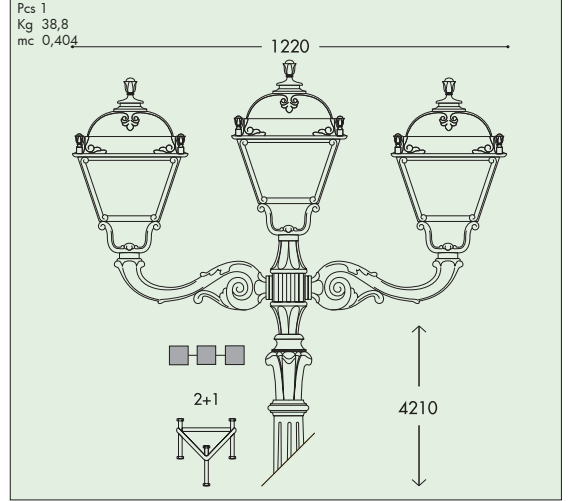

**HOREB ADAM/SIMON 3L**

**E27** U33.207.M30  
**LED** U35.207.M30

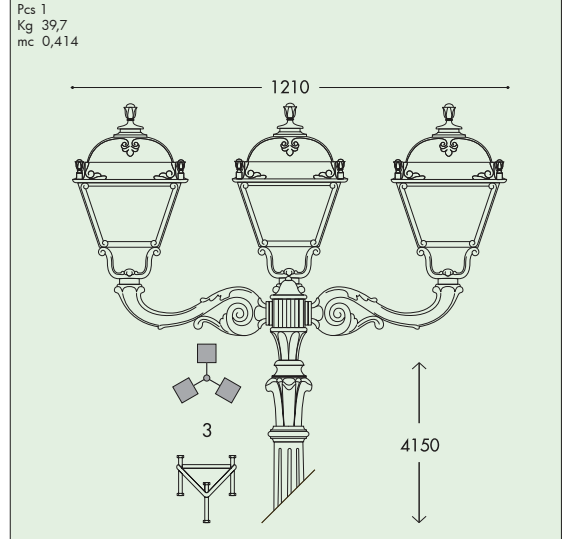

**HOREB ADAM/SIMON 2L**

**E27** U33.207.M20  
**LED** U35.207.M20

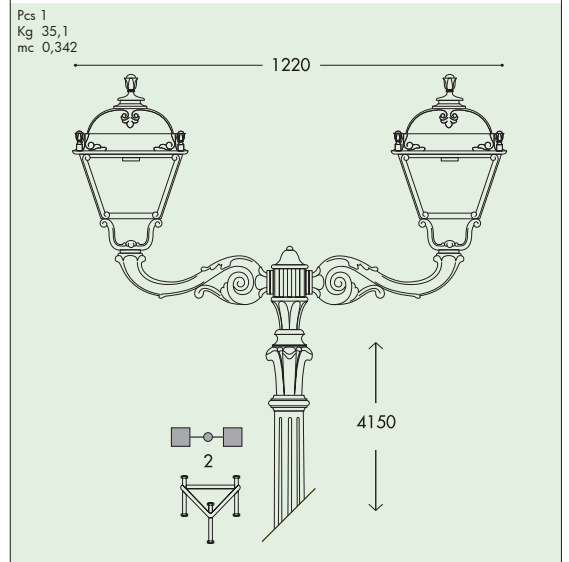

BULKHEAD  
FLOODLIGHT  
IN-GROUND  
BRICKLIGHT  
BOLLARDS  
GARDEN  
URBAN CLASSIC  
URBAN MODERN  
HIGH-BAY  
POST  
LAMPS

KARMEL 3000/SIMON  
LARGE SIZE

BULKHEAD  
FLOODLIGHT  
IN-GROUND  
BRICKLIGHT  
BOLLARDS  
GARDEN  
URBAN CLASSIC  
URBAN MODERN  
HIGH-BAY  
POST  
LAMPS

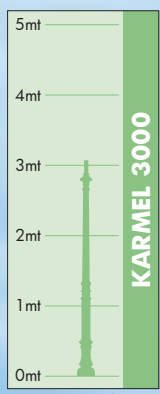



**KARMEL 3000 OFIR/SIMON 2L**

**E27** U33.231.R20  
**LED** U35.231.R20

Pcs 1  
Kg 34,2  
mc 0,295

**KARMEL 3000 OFIR/SIMON 3L**

**E27** U33.231.R30  
**LED** U35.231.R30

Pcs 1  
Kg 37,9  
mc 0,369

**KARMEL 3000/SIMON**

**E27** U33.231  
**LED** U35.231

Pcs 1  
Kg 27  
mc 0,223

**KARMEL 3000 OFIR/SIMON 2L**

**E27** U33.231.R20  
**LED** U35.231.R20

Pcs 1  
Kg 34,2  
mc 0,295

**KARMEL 3000 OFIR/SIMON 3L**

**E27** U33.231.R30  
**LED** U35.231.R30

Pcs 1  
Kg 37,9  
mc 0,369

KARMEL 3500-4000/**SIMON**  
LARGE SIZE

BULKHEAD  
FLOODLIGHT  
IN-GROUND  
BRICKLIGHT  
BOLLARDS  
GARDEN  
URBAN CLASSIC  
URBAN MODERN  
HIGH-BAY  
POST  
LAMPS





**KARMEL 3500-4000/SIMON**  
**LARGE SIZE**

KARMEL 3500 ADAM/SIMON 1L	KARMEL 4000 ADAM/SIMON 1L
<b>E27</b> U33.234.M10	U33.237.M10
<b>LED</b> U35.234.M10	U35.237.M10
Pcs 1 Kg 30,4 mc 0,280	Pcs 1 Kg 33,9 mc 0,287

KARMEL 3500/SIMON	
<b>E27</b>	U33.234
<b>LED</b>	U35.234
Pcs 1 Kg 28,5 mc 0,249	

KARMEL 3500 ADAM/SIMON 2+1	KARMEL 4000 ADAM/SIMON 2+1
<b>E27</b> U33.234.M21	U33.237.M21
<b>LED</b> U35.234.M21	U35.237.M21
Pcs 1 Kg 38,8 mc 0,404	Pcs 1 Kg 42,3 mc 0,431

KARMEL 3500 ADAM/SIMON 3L	KARMEL 4000 ADAM/SIMON 3L
<b>E27</b> U33.234.M30	U33.237.M30
<b>LED</b> U35.234.M30	U35.237.M30
Pcs 1 Kg 39,7 mc 0,414	Pcs 1 Kg 43,2 mc 0,441

KARMEL 3500 ADAM/SIMON 3+1	KARMEL 4000 ADAM/SIMON 3+1
<b>E27</b> U33.234.M31	U33.237.M31
<b>LED</b> U35.234.M31	U35.237.M31
Pcs 1 Kg 43,4 mc 0,476	Pcs 1 Kg 46,9 mc 0,503

KARMEL 3500 ADAM/SIMON 2L	KARMEL 4000 ADAM/SIMON 2L
<b>E27</b> U33.234.M20	U33.237.M20
<b>LED</b> U35.234.M20	U35.237.M20
Pcs 1 Kg 35,1 mc 0,342	Pcs 1 Kg 38,7 mc 0,369

BULKHEAD  
FLOODLIGHT  
IN-GROUND  
BRICKLIGHT  
BOLLARDS  
GARDEN  
URBAN CLASSIC  
URBAN/MODERN  
HIGH-BAY  
POST  
LAMPS

# ELIA

## GRAND SIZE

E27 square lantern in classic style, made of shockproof resin material, UV-rays stabilized, rust and corrosion-free. Modular construction suitable for post top, hanging and wall installation. Provided with high temperature resistant ceiling suitable for ballast fixation. Insulation class II, protection rating IP 55.

*Lantern quadra E27 in stile classico, realizzata in resina antiurto, stabilizzata ai raggi UV, inattaccabile da ruggine e corrosione. Idonea per il montaggio a palo, a sospensione o a parete. Fornita con soffitto ad alta resistenza al calore idoneo per il fissaggio dei reattori. Classe di isolamento II, grado di protezione IP55.*



Q43.000.H10

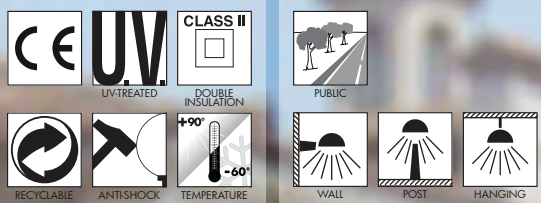

BULKHEAD  
FLOODLIGHT  
IN-GROUND  
BRICKLIGHT  
BOLLARDS  
GARDEN  
URBAN CLASSIC  
URBAN MODERN  
HIGH-BAY  
POST  
LAMPS



**ELIA - LANTERN COMPONENTS**

**IP55**



Decorative **PINNACLE** to be mounted on the roof top for post installation or on the lantern base for hanging installation.

**PINNACOLO** decorativo applicabile alla sommità del tetto (montaggio a palo) o sulla base della gabbia (montaggio a sospensione).

**ROOF** made of shockproof resin material, UV-rays stabilized. Tool-free opening for relamping and access to control-gear.

**TETTO** realizzato in resina antiurto, stabilizzata ai raggi UV. Rimovibile senza l'ausilio di attrezzi per manutenzione e cambio lampadina.

**DIFFUSER** of UV-rays stabilized polymethylmethacrylate (PMMA), one piece only, with recess for a power supply cable. Available in clear or opal colour. For the version MBF 250W or higher and HQI/SON 150W or higher the enclosure is open at the bottom, enabling a correct disposal of the heat inside the diffuser.

**DIFFUSORE** in polimetilmacrilato (PMMA) resistente all'ingiallimento ed ai raggi UV, disponibile in colore trasparente o opale, realizzato in unico pezzo, provvisto di sede per alloggiamento del cavo di alimentazione. Per la versione MBF 250W o superiore e HQI/SON 150W o superiore il diffusore è aperto alla base per un corretto smaltimento del calore nel vano ottico.

**CAGE** made of shockproof resin material, UV-rays stabilized, rust and corrosion-free.

**GABBIA** realizzata in resina antiurto, stabilizzata ai raggi UV, inattaccabile da ruggine e corrosione.

**ELIA**

Q43.000 \*

open diffuser Q44.000\*



**Dimensions and weight**

Height: 740 mm  
Width: 430 mm  
Depth: 430 mm  
Weight: 7,5 Kg  
Junction to support: diameter 60 mm  
Area exposed to wind pressure:  
CxS = m<sup>2</sup> 0,165

**Moulded colours:**

Black White

**Painted colours:**

Antique green Antique bronze

**Diffuser PMMA:**

Clear Opal

**E27 - E40**



Lantern supplied with high temperature resistant **CEILING** made of white polycarbonate (PC), complete with **E27 or E40 lampholder**.

\*ADD. SUFFIX

CLOSED DIFFUSER IP55	<b>E27</b> (GLS-CFL-LED) (SON/HQI/MBF) MAX 125W	E27 lampholder only	.E27
	<b>E40</b> (SON/HQI) 100W	E40 lampholder only	.E40
OPEN DIFFUSER	<b>E40</b> (SON/HQI/MBF) MAX 400W	E40 lampholder only	.E40

**E27 - E40 WITH BALLAST KIT**



Lantern supplied with high temperature resistant **CEILING** made of white polycarbonate (PC), complete with E27 or E40 lampholder and with **ballast kit** for SON-HQI lamps.

\*ADD. SUFFIX

CLOSED DIFFUSER IP55	<b>E27</b> WITH BALLAST KIT	SON 70W	.S70
		HQI 70W	.H70
OPEN DIFFUSER	<b>E40</b> WITH BALLAST KIT	SON 100W	.S10
		HQI 100W	.H10
OPEN DIFFUSER	<b>E40</b> WITH BALLAST KIT	SON 150W	.S15
		HQI 150W	.H15

**CHROME ALUMINIUM LOUVRE**

H.FC6 open  
Downward position



\* ADD THESE SUFFIXES TO THE REFERENCES MENTIONED IN THE CATALOGUE

**PHOTOMETRIC DATA SAMPLE**

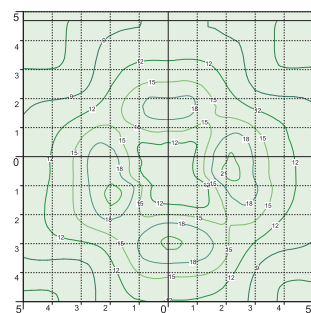
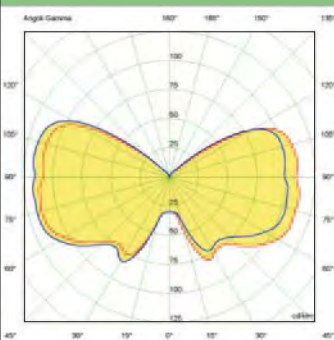

**ELIA lantern clear SON 100W.**

POST height 4,5mt  
10 x 10mt area: average 12 lux

The photometric data for all the versions are available upon request or on our website.



# ELIA LED

## GRAND SIZE

Square lantern in classic style, made of shockproof resin material, UV-rays stabilized, rust and corrosion-free. Modular construction suitable for post top, hanging and wall installation. Supplied as standard with **FLAT diffuser** and equipped with long-life, powerful and efficient TÜV approved GX53 LED modular system in different wattages. Designed according to the international regulations against light pollution (standard UNI 10819). Insulation class II, Protection rating IP 65.

*Lantern quadra in stile classico, realizzata in resina antiurto, stabilizzata ai raggi UV, inattaccabile da ruggine e corrosione. Idonea per il montaggio a palo, a sospensione o a parete. Fornita con **diffusore piatto** ed equipaggiata con sistema modulare a LED GX53 approvato TÜV di lunga durata ed alta efficienza disponibile in diverse potenze. Progettato in ottemperanza alle norme internazionali contro l'inquinamento luminoso (standard UNI 10819). Classe di isolamento II, grado di protezione IP65.*



Q45.000.D8L

BULKHEAD  
FLOODLIGHT  
IN-GROUND  
BRICKLIGHT  
BOLLARDS  
GARDEN  
URBAN CLASSIC  
URBAN MODERN  
HIGH-BAY  
POST  
LAMPS



**ELIA LED - LANTERN COMPONENTS**

**IP65**



Decorative **PINNACLE** to be mounted on the roof top for post installation or on the lantern base for hanging installation.

**PINNACOLO** decorativo applicabile alla sommità del tetto (montaggio a palo) o sulla base della gabbia (montaggio a sospensione).

**LANTERN ROOF** made of shockproof resin material, UV-rays stabilized. Tool-free opening for relamping and maintenance.

**TETTO** realizzato in resina antiurto, stabilizzata ai raggi UV. Rimovibile senza l'ausilio di attrezzi per manutenzione e cambio lampadina.

**DIFFUSER** with flat shape made of UV-rays stabilized polymethylmethacrylate (PMMA), provided with silicone rubber gasket to ensure an increased protection against external agent. Version with full diffuser available upon request.

**DIFFUSORE** in polimetilmetacrilato (PMMA) con configurazione piatta, provvisto di guarnizione in gomma siliconica per garantire una migliore protezione contro gli agenti esterni. Disponibile su richiesta anche versione con diffusore pieno.

**CAGE** made of shockproof resin material, UV-rays stabilized, rust and corrosion-free.

**GABBIA** realizzata in resina antiurto, stabilizzata ai raggi UV, inattaccabile da ruggine e corrosione.

**ELIA LED**

Q45.000 \*



**Dimensions and weight**

Height: 740 mm  
Width: 430 mm  
Depth: 430 mm  
Weight: 9,1 Kg

Area exposed to wind pressure:  
CxS = m<sup>2</sup> 0,165

**Moulded colours:**

Black White

**Painted colours:**

Antique green Antique bronze

**Diffuser PMMA:**

Clear Opal

**GX53 LED**



- **COST SAVING:** long-life and efficient LED light sources.
- **BUILT-IN DRIVER:** quick and easy lamp replacement
- **GREAT FLEXIBILITY:** GX53 standard lamp holder.
- **FUTURE-PROOFED LUMINARIES:** performances easy to upgrade to latest technology developments.
- **SUITABLE FOR OUTDOOR USE:** built-in driver fully protected against heat and humidity by silicone paste.

\*ADD. SUFFIX

Lantern supplied with white resin CEILING provided with TÜV approved, long-life and efficient **8xGX53 LED lamps included**. Each lamp can be quickly and easily replaced individually, making the luminaries maintenance very simple.



8x 7 W  
**56 W**

**6400 Lm**

4000 K .C8L

3000 K .C8R

8x 10 W  
**80 W**

**9600 Lm**

4000 K .D8L

3000 K .D8R

**LED LAMPS**



More technical details about TÜV approved Fumagalli LED Lamps on page 468.

\* ADD THESE SUFFIXES TO THE REFERENCES MENTIONED IN THE CATALOGUE

**PHOTOMETRIC DATA SAMPLE**

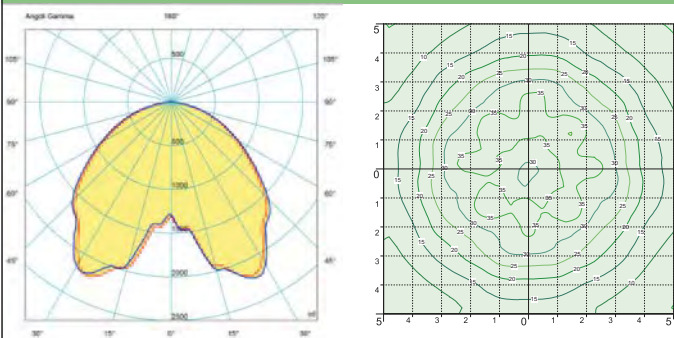

**ELIA LED**



**SAVE -63%**

8x7W GX53 LED  
**56W**  
(power consumption)

Area: 10x10mt  
Height: 5mt

**21 lux**

**ELIA E27**



HQI - SON  
**150W**  
(power consumption)

Area: 10x10mt  
Height: 5mt

**15 lux**

**ELIA**  
GRAND SIZE



MADE IN ITALY

BULKHEAD  
FLOODLIGHT  
IN-GROUND  
BRICKLIGHT  
BOLLARDS  
GARDEN  
URBAN CLASSIC  
URBAN MODERN  
HIGH-BAY  
POST  
LAMPS

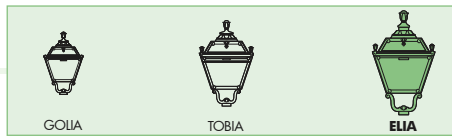

GIONA 5000/ELIA	
<b>E27</b>	Q43.227
<b>LED</b>	Q45.227
Pcs 1 Kg 64,5 mc 1,112	430

5680

400

GIONA 4000/ELIA	GIONA 4500/ELIA
<b>E27</b> Q43.221	Q43.224
<b>LED</b> Q45.221	Q45.224
Pcs 1 Kg 58,5 mc 0,862	Pcs 1 Kg 61,5 mc 0,982

430

4680  
5180

400

KARMEL 3500/ELIA	KARMEL 4000/ELIA
<b>E27</b> Q43.234	Q43.237
<b>LED</b> Q45.234	Q45.237
Pcs 1 Kg 32,5 mc 0,402	Pcs 1 Kg 36 mc 0,453

430

4180  
4680

Ø 275

SICHEM/ELIA	
<b>E27</b>	Q43.121
<b>LED</b>	Q45.121
Pcs 1 Kg 8 mc 0,182	430

1150

ELIA	
<b>E27</b>	Q43.000
<b>LED</b>	Q45.000
Pcs 1 Kg 7,5 mc 0,182	430

740

Ø 60

TABOR/ELIA	HOREB/ELIA
<b>E27</b> Q43.204	Q43.207
<b>LED</b> Q45.204	Q45.207
Pcs 1 Kg 31 mc 0,362	Pcs 1 Kg 32,5 mc 0,402

430

3680  
4180

Ø 275

KARMEL 3000/ELIA	
<b>E27</b>	Q43.231
<b>LED</b>	Q45.231
Pcs 1 Kg 31 mc 0,362	430

430

3680

Ø 275

GIONA 4000/**ELIA**  
GRAND SIZE

BULKHEAD  
FLOODLIGHT  
IN-GROUND  
BRICKLIGHT  
BOLLARDS  
GARDEN  
URBAN CLASSIC  
URBAN MODERN  
HIGH-BAY  
POST  
LAMPS

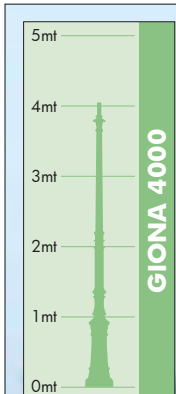

Pag.456



MADE IN  
ITALY



**ADAM/ELIA**

**E27** Q43.171  
**LED** Q45.171

Pcs 1  
Kg 9,3  
mc 0,190

**GIONA 4000 ADAM/ELIA 2L**

**E27** Q43.221.M20  
**LED** Q45.221.M20

Pcs 1  
Kg 70,6  
mc 0,863

**LOT/ELIA**

**E27** Q43.113  
**LED** Q45.113

Pcs 1  
Kg 8,4  
mc 0,182

**GIONA 4000 ADAM/ELIA 1L**

**E27** Q43.221.M10  
**LED** Q45.221.M10

Pcs 1  
Kg 61,3  
mc 0,752

**GIONA 4000 ADAM/ELIA 2L**

**E27** Q43.221.M30  
**LED** Q45.221.M30

Pcs 1  
Kg 80  
mc 1,100

**GIONA 4000 ADAM/ELIA 3L**

**E27** Q43.221.M30  
**LED** Q45.221.M30

Pcs 1  
Kg 80  
mc 1,100

**GIONA 4000 ADAM/ELIA 2+1**

**E27** Q43.221.M21  
**LED** Q45.221.M21

Pcs 1  
Kg 79,1  
mc 0,931

GIONA 4500-5000/**ELIA**  
GRAND SIZE

BULKHEAD  
FLOODLIGHT  
IN-GROUND  
BRICKLIGHT  
BOLLARDS  
GARDEN  
URBAN CLASSIC  
URBAN MODERN  
HIGH-BAY  
POST  
LAMPS





GIONA 4500 ARON/ELIA		GIONA 5000 ARON/ELIA	
<b>E27</b> Q43.224.N10	<b>E27</b> Q43.227.N10	<b>E27</b> Q43.224.N10	<b>E27</b> Q43.227.N10
<b>LED</b> Q45.224.N10	<b>LED</b> Q45.227.N10	<b>LED</b> Q45.224.N10	<b>LED</b> Q45.227.N10
Pcs 1 Kg 65 mc 0,949	Pcs 1 Kg 68 mc 1,191	Pcs 1 Kg 65 mc 0,949	Pcs 1 Kg 68 mc 1,191

ARON/ELIA	
<b>E27</b> Q43.172	<b>E27</b> Q43.172
<b>LED</b> Q45.172	<b>LED</b> Q45.172
Pcs 1 Kg 10,5 mc 0,223	Pcs 1 Kg 10,5 mc 0,223

GIONA 4500 ARON/ELIA 2L		GIONA 5000 ARON/ELIA 2L	
<b>E27</b> Q43.224.N20	<b>E27</b> Q43.227.N20	<b>E27</b> Q43.224.N20	<b>E27</b> Q43.227.N20
<b>LED</b> Q45.224.N20	<b>LED</b> Q45.227.N20	<b>LED</b> Q45.224.N20	<b>LED</b> Q45.227.N20
Pcs 1 Kg 74 mc 1,196	Pcs 1 Kg 77 mc 1,329	Pcs 1 Kg 74 mc 1,196	Pcs 1 Kg 77 mc 1,329

GIONA 4500 ARON/ELIA 4L		GIONA 5000 ARON/ELIA 4L	
<b>E27</b> Q43.224.N40	<b>E27</b> Q43.227.N40	<b>E27</b> Q43.224.N40	<b>E27</b> Q43.227.N40
<b>LED</b> Q45.224.N40	<b>LED</b> Q45.227.N40	<b>LED</b> Q45.224.N40	<b>LED</b> Q45.227.N40
Pcs 1 Kg 92 mc 1,444	Pcs 1 Kg 95 mc 1,605	Pcs 1 Kg 92 mc 1,444	Pcs 1 Kg 95 mc 1,605

ERMON.R/ELIA	
<b>E27</b> Q43.195 resin	<b>E27</b> Q43.195 resin
<b>LED</b> Q45.195 resin	<b>LED</b> Q45.195 resin
Pcs 1 Kg 12,8 mc 0,250	Pcs 1 Kg 12,8 mc 0,250



# PIETRO

## GRAND SIZE

E27 square lantern in classic style, made of shockproof resin material, UV-rays stabilized, rust and corrosion-free. Modular construction suitable for post top, hanging and wall installation. Provided with high temperature resistant ceiling suitable for ballast fixation. Insulation class II, protection rating IP 55.

*Lantern quadra E27 in stile classico, realizzata in resina antiurto, stabilizzata ai raggi UV, inattaccabile da ruggine e corrosione. Idonea per il montaggio a palo, a sospensione o a parete. Fornita con soffitto ad alta resistenza al calore idoneo per il fissaggio dei reattori. Classe di isolamento II, grado di protezione IP55.*



U43.000.H10

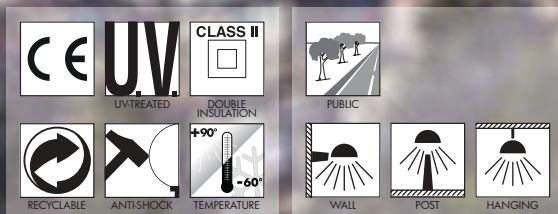

BULKHEAD  
FLOODLIGHT  
IN-GROUND  
BRICKLIGHT  
BOLLARDS  
GARDEN  
URBAN CLASSIC  
URBAN MODERN  
HIGH-BAY  
POST  
LAMPS



**PIETRO - LANTERN COMPONENTS**

IP55



Decorative **PINNACLE** to be mounted on the roof top for post installation or on the lantern base for hanging installation.

**PINNACOLO** decorativo applicabile alla sommità del tetto (montaggio a palo) o sulla base della gabbia (montaggio a sospensione).

Lantern **ROOF** made of shockproof resin material, UV-rays stabilized. Tool-free opening for relamping and access to control-gear.

**TETTO** realizzato in resina antiurto, stabilizzata ai raggi UV. Rimovibile senza l'ausilio di attrezzi per manutenzione e cambio lampadina.

**DIFFUSER** of UV-rays stabilized polymethylmethacrylate (PMMA), one piece only, with recess for a power supply cable. Available in clear or opal colour. For the version MBF 250W or higher and HQI/SON 150W or higher the enclosure is open at the bottom, enabling a correct disposal of the heat inside the diffuser.

**DIFFUSORE** in polimetilmetacrilato (PMMA) resistente all'ingiallimento ed ai raggi UV, disponibile in colore trasparente o opale, realizzato in unico pezzo, provvisto di sede per alloggiamento del cavo di alimentazione. Per la versione MBF 250W o superiore e HQI/SON 150W o superiore il diffusore è aperto alla base per un corretto smaltimento del calore nel vano ottico.

**CAGE** made of shockproof resin material, UV-rays stabilized, rust and corrosion-free.

**GABBIA** realizzata in resina antiurto, stabilizzata ai raggi UV, inattaccabile da ruggine e corrosione.

**PIETRO**

U43.000 \*

open diffuser U44.000\*



**Dimensions and weight**

Height: 770 mm  
Width: 430 mm  
Depth: 430 mm  
Weight: 7,5 Kg  
Junction to support: diameter 60 mm  
Area exposed to wind pressure:  
CxS = m<sup>2</sup> 0,182

**Moulded colours:**

Black White

**Painted colours:**

Antique green Antique bronze

**Diffuser PMMA:**

Clear Opal

**E27 - E40**



Lantern supplied with high temperature resistant CEILING made of white polycarbonate (PC), complete with E27 or E40 lampholder.

\*ADD. SUFFIX

CLOSED DIFFUSER IP55	<b>E27</b> (GLS-CFL-LED) (SON/HQI/MBF) MAX 125W	E27 lampholder only	.E27
	<b>E40</b> (SON/HQI) 100W	E40 lampholder only	.E40
OPEN DIFFUSER	<b>E40</b> (SON/HQI/MBF) MAX 400W	E40 lampholder only	.E40

**E27 - E40 WITH BALLAST KIT**



Lantern supplied with high temperature resistant CEILING made of white polycarbonate (PC), complete with E27 or E40 lampholder and with ballast kit for SON-HQI lamps.

\*ADD. SUFFIX

CLOSED DIFFUSER IP55	<b>E27</b> WITH BALLAST KIT	SON 70W	.S70
		HQI 70W	.H70
OPEN DIFFUSER	<b>E40</b> WITH BALLAST KIT	SON 100W	.S10
		HQI 100W	.H10
OPEN DIFFUSER	<b>E40</b> WITH BALLAST KIT	SON 150W	.S15
		HQI 150W	.H15

**CHROME ALUMINIUM LOUVRE**

H.FC6 open  
Downward position



\* ADD THESE SUFFIXES TO THE REFERENCES MENTIONED IN THE CATALOGUE

**PHOTOMETRIC DATA SAMPLE**

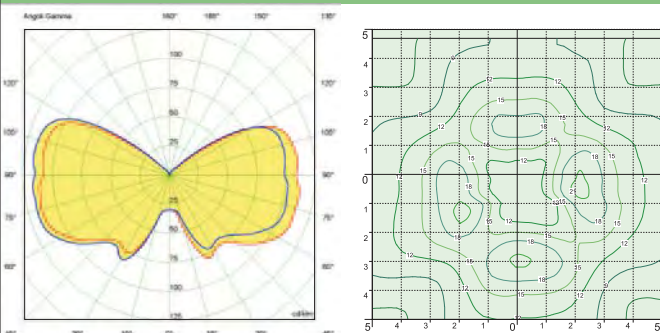

**PIETRO lantern clear SON 100W.**

POST height 4,5mt  
10 x 10mt area: average 12 lux

The photometric data for all the versions are available upon request or on our website.

# PIETRO LED

## GRAND SIZE

Square lantern in classic style, made of shockproof resin material, UV-rays stabilized, rust and corrosion-free. Modular construction suitable for post top, hanging and wall installation. Supplied as standard with **FLAT diffuser** and equipped with long-life, powerful and efficient TÜV approved GX53 LED modular system in different wattages. Designed according to the international regulations against light pollution (standard UNI 10819). Insulation class II, Protection rating IP 65.

*Lantern quadra in stile classico, realizzata in resina antiurto, stabilizzata ai raggi UV, inattaccabile da ruggine e corrosione. Idonea per il montaggio a palo, a sospensione o a parete. Fornita con **diffusore piatto** ed equipaggiata con sistema modulare a LED GX53 approvato TÜV di lunga durata ed alta efficienza disponibile in diverse potenze. Progettato in ottemperanza alle norme internazionali contro l'inquinamento luminoso (standard UNI 10819). Classe di isolamento II, grado di protezione IP65.*

U45.000.D8L

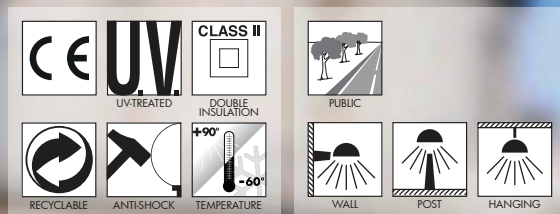



**PIETRO LED - LANTERN COMPONENTS**

**IP65**



Decorative **PINNACLE** to be mounted on the roof top for post installation or on the lantern base for hanging installation.

**PINNACOLO** decorativo applicabile alla sommità del tetto (montaggio a palo) o sulla base della gabbia (montaggio a sospensione).

**LANTERN ROOF** made of shockproof resin material, UV-rays stabilized. Tool-free opening for relamping and maintenance.

**TETTO** realizzato in resina antiurto, stabilizzata ai raggi UV. Rimovibile senza l'ausilio di attrezzi per manutenzione e cambio lampadina.

**DIFFUSER** with flat shape made of UV-rays stabilized polymethylmethacrylate (PMMA), provided with silicone rubber gasket to ensure an increased protection against external agent. Version with full diffuser available upon request.

**DIFFUSORE** in polimetilmetacrilato (PMMA) con configurazione piatta, provvisto di guarnizione in gomma silconica per garantire una migliore protezione contro gli agenti esterni. Disponibile su richiesta anche versione con diffusore pieno.

**CAGE** made of shockproof resin material, UV-rays stabilized, rust and corrosion-free.

**GABBIA** realizzata in resina antiurto, stabilizzata ai raggi UV, inattaccabile da ruggine e corrosione.

**PIETRO LED**

U45.000 \*



**Dimensions and weight**

Height: 770 mm  
Width: 430 mm  
Depth: 430 mm  
Weight: 9,1 Kg  
Junction to support: diameter 60 mm  
Area exposed to wind pressure: CxS = m<sup>2</sup> 0,182

**Moulded colours:**

Black  White

**Painted colours:**

Antique green  Antique bronze

**Diffuser PMMA:**

Clear  Opal

**GX53 LED**



- **COST SAVING:** long-life and efficient LED light sources.
- **BUILT-IN DRIVER:** quick and easy lamp replacement
- **GREAT FLEXIBILITY:** GX53 standard lamp holder.
- **FUTURE-PROOFED LUMINARIES:** performances easy to upgrade to latest technology developments.
- **SUITABLE FOR OUTDOOR USE:** built-in driver fully protected against heat and humidity by silicone paste.

\*ADD. SUFFIX

Lantern supplied with white resin CEILING provided with TÜV approved, long-life and efficient **8xGX53 LED lamps included**. Each lamp can be quickly and easily replaced individually, making the luminaries maintenance very simple.



8x 7 W  
**56 W**

**6400 Lm**

4000 K .C8L

3000 K .C8R

8x 10 W  
**80 W**

**9600 Lm**

4000 K .D8L

3000 K .D8R

**LED LAMPS**

More technical details about TÜV approved Fumagalli LED Lamps on page 468.



\* ADD THESE SUFFIXES TO THE REFERENCES MENTIONED IN THE CATALOGUE

**PHOTOMETRIC DATA SAMPLE**

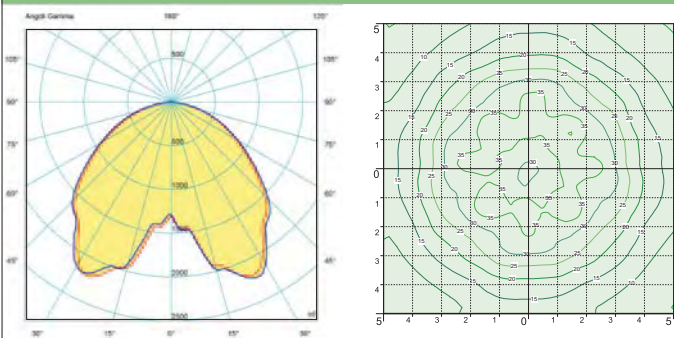

**PIETRO LED**



**SAVE -63%**

8x7W GX53 LED  
**56W**  
(power consumption)

Area: 10x10mt  
Height: 5mt  
**21 lux**

**PIETRO E27**



HQI - SON  
**150W**  
(power consumption)

Area: 10x10mt  
Height: 5mt  
**15 lux**

**PIETRO**  
GRAND SIZE

BULKHEAD

FLOODLIGHT

IN-GROUND

BRICKLIGHT

BOLLARDS

GARDEN

URBAN CLASSIC

URBAN MODERN

HIGH-BAY

POST

LAMPS



U43.224



U43.113

MADE IN ITALY



GIONA 5000/PIETRO	
<b>E27</b>	U43.227
<b>LED</b>	U45.227
Pcs 1 Kg 64,5 mc 1,112	

GIONA 4000/PIETRO	GIONA 4500/PIETRO
<b>E27</b> U43.221	U43.224
<b>LED</b> U45.221	U45.224
Pcs 1 Kg 58,5 mc 0,862	Pcs 1 Kg 61,5 mc 0,982

KARMEL 3500/PIETRO	KARMEL 4000/PIETRO
<b>E27</b> U43.234	U43.237
<b>LED</b> U45.234	U45.237
Pcs 1 Kg 32,5 mc 0,402	Pcs 1 Kg 36 mc 0,453

LOT/PIETRO	
<b>E27</b>	U43.113
<b>LED</b>	U45.113
Pcs 1 Kg 8,4 mc 0,182	

KARMEL 3000/PIETRO	
<b>E27</b>	U43.231
<b>LED</b>	U45.231
Pcs 1 Kg 31 mc 0,362	

PIETRO	
<b>E27</b>	U43.000
<b>LED</b>	U45.000
Pcs 1 Kg 7,5 mc 0,182	

TABOR/PIETRO	HOREB/PIETRO
<b>E27</b> U43.204	U43.207
<b>LED</b> U45.204	U45.207
Pcs 1 Kg 31 mc 0,362	Pcs 1 Kg 32,5 mc 0,402

BULKHEAD  
FLOODLIGHT  
IN-GROUND  
BRICKLIGHT  
BOLLARDS  
GARDEN  
URBAN CLASSIC  
URBAN MODERN  
HIGH-BAY  
POST  
LAMPS

GIONA 4000/**PIETRO**  
GRAND SIZE

BULKHEAD  
FLOODLIGHT  
IN-GROUND  
BRICKLIGHT  
BOLLARDS  
GARDEN  
URBAN CLASSIC  
URBAN MODERN  
HIGH-BAY  
POST  
LAMPS

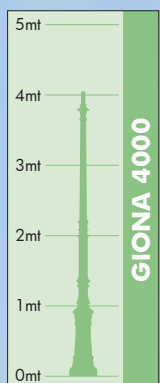

Pag.456



MADE IN ITALY



**ADAM/PIETRO**

**E27** U43.171  
**LED** U45.171

Pcs 1  
Kg 9,3  
mc 0,190

**GIONA 4000 ADAM/PIETRO 3L**

**E27** U43.221.M30  
**LED** U45.221.M30

Pcs 1  
Kg 80  
mc 1,100

**SICHEM/PIETRO**

**E27** U43.121  
**LED** U45.121

Pcs 1  
Kg 8  
mc 0,182

**GIONA 4000 ADAM/PIETRO 1L**

**E27** U43.221.M10  
**LED** U45.221.M10

800

4090

1

400

Pcs 1  
Kg 61,3  
mc 0,752

**GIONA 4000 ADAM/PIETRO 2+1**

**E27** U43.221.M21  
**LED** U45.221.M21

1500

4920

2+1

4860

3

400

Pcs 1  
Kg 79,1  
mc 0,931

**GIONA 4000 ADAM/PIETRO 2L**

**E27** U43.221.M20  
**LED** U45.221.M20

1500

4860

2

Pcs 1  
Kg 70,6  
mc 0,863



- BULKHEAD
- FLOODLIGHT
- IN-GROUND
- BRICKLIGHT
- BOLLARDS
- GARDEN
- URBAN CLASSIC
- URBAN MODERN
- HIGH-BAY
- POST
- LAMPS

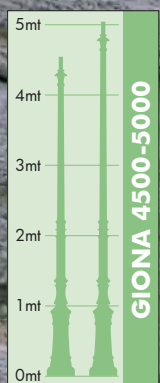

U43.172





BULKHEAD

FLOODLIGHT

IN-GROUND

BRICKLIGHT

BOLLARDS

GARDEN

URBAN CLASSIC

URBAN MODERN

HIGH-BAY

POST

LAMPS

GIONA 4500 ARON/PIETRO 1L		GIONA 5000 ARON/PIETRO 1L	
<b>E27</b>	U43.224.N10	U43.227.N10	
<b>LED</b>	U45.224.N10	U45.227.N10	
Pcs 1		Pcs 1	
Kg 65		Kg 68	
mc 0,949		mc 1,191	

ARON/PIETRO	
<b>E27</b>	U43.172
<b>LED</b>	U45.172
Pcs 1	
Kg 10,5	
mc 0,223	

GIONA 4500 ARON/PIETRO 2L		GIONA 5000 ARON/PIETRO 2L	
<b>E27</b>	U43.224.N20	<b>E27</b>	U43.227.N20
<b>LED</b>	U45.224.N20	<b>LED</b>	U45.227.N20
Pcs 1		Pcs 1	
Kg 74		Kg 77	
mc 1,196		mc 1,329	

GIONA 4500 ARON/PIETRO 4L		GIONA 5000 ARON/PIETRO 4L	
<b>E27</b>	U43.224.N40	<b>E27</b>	U43.227.N40
<b>LED</b>	U45.224.N40	<b>LED</b>	U45.227.N40
Pcs 1		Pcs 1	
Kg 92		Kg 95	
mc 1,444		mc 1,605	

ERMON.R/PIETRO	
<b>E27</b>	U43.195 resin
<b>LED</b>	U45.195 resin
Pcs 1	
Kg 12,8	
mc 0,250	

# GLOBE 400 CLASSIC

## LARGE SIZE

Ø 400 mm PMMA globe, complete with classic base made of shockproof resin material, UV-rays stabilized, rust and corrosion-free. Suitable for post top, hanging and wall installation. Provided with E27 lampholder and prepared for ballast and louvre fixation. Insulation class II, protection rating IP65.

*Globo Ø 400 mm in polimetilmetacrilato (PMMA) completo di base classica realizzata in resina antiurto, stabilizzata ai raggi UV, inattaccabile da ruggine e corrosione. Idoneo per il montaggio a palo, a sospensione o a parete. Fornito con portalampada E27 e predisposto per il fissaggio dei reattori e del frangiluce. Classe di isolamento II, grado di protezione IP65.*

BULKHEAD  
FLOODLIGHT  
IN-GROUND  
BRICKLIGHT  
BOLLARDS  
GARDEN  
URBAN CLASSIC  
URBAN MODERN  
HIGH-BAY  
POST  
LAMPS





**GLOBE 400 CLASSIC - COMPONENTS**

**IP65**

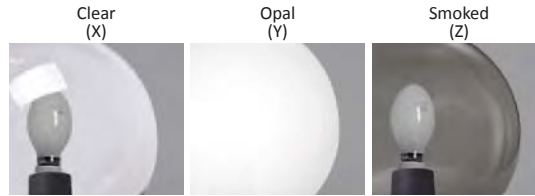

**400 mm GLOBE** made of UV-rays stabilized polymethylmethacrylate (PMMA), one piece only. Available in clear, opal or smoked colour.

**GLOBO Ø 400 mm** in polimetilmetacrilato (PMMA), resistente all'ingiallimento ed ai raggi UV, realizzato in un unico pezzo. Disponibile nei colori trasparente, bianco o fumé.



Chrome aluminium **LOUVRE** with a laminar symmetrical optic system to direct the lighting output and to get a lower dazzle (optional).

**FRANGILUCE** in alluminio cromato con sistema ottico lamellare a ripartizione simmetrica per orientare il fascio di luce e ridurre l'abbagliamento (opzionale).

Globe **BASE**, made of shockproof resin material, UV-rays stabilized, rust and corrosion-free, consisting of a support and of a cover suitable for ballast kit fixation on its lower side and provided with E27 lampholder on its upper side. A rubber gasket assures the protection of the electrical accessories seat against external agents.

**BASE** del globo, realizzata in resina antiurto, stabilizzata ai raggi UV, inattaccabile da ruggine e corrosione. Composta da un supporto e da un coperchio nella cui parte inferiore possono essere fissati gli accessori elettrici e nella cui parte superiore si trova l'alloggiamento per il portalampada E27 (incluso). Una guarnizione in gomma garantisce la protezione dell'alloggiamento degli accessori elettrici dagli agenti esterni.

**GLOBE 400 CLASSIC**

G40.B40 \*



**Dimensions and weight**

Height: 410 mm  
Diameter: 400 mm  
Junction to support: diameter 60 mm  
Weight: 2,1 Kg  
Area exposed to wind pressure:  
CxS = m<sup>2</sup> 0,122

**Moulded colours:**

Black   White

**Painted colours:**

Antique green   Antique bronze

**Diffuser PMMA:**

Clear   Opal   Smoked

**CHROME ALUMINIUM LOUVRE**

H.FC1 closed  
Upward position



H.FC6 open  
Downward position



**E27**

\*ADD. SUFFIX

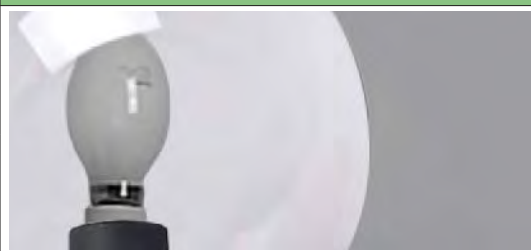

Globe complete with classic base and **E27** lampholder. Provided as an option with ballast kit for SON-HQI.

<b>E27</b> (GLS-CFL-LED)	E27 Lampholder only	.E27
<b>E27</b> WITH BALLAST KIT	SON 70W	.S70
	HQI 70W	.H70

**PHOTOMETRIC DATA SAMPLE**

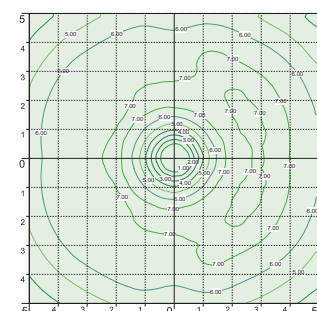
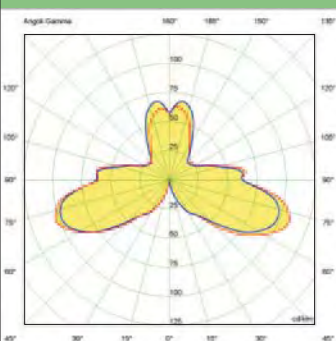

**GLOBE 400 CLASSIC** clear SON 70W (with louvre).

POST height 3,5mt  
10 x 10mt area: average 6 lux

The photometric data for all the versions are available upon request or on our website.

\* ADD THE ABOVE SUFFIXES TO THE REFERENCES MENTIONED IN THE CATALOGUE

# TABOR/GLOBE 400 CLASSIC LARGE SIZE

BULKHEAD  
FLOODLIGHT  
IN-GROUND  
BRICKLIGHT  
BOLLARDS  
GARDEN  
URBAN CLASSIC  
URBAN MODERN  
HIGH-BAY  
POST  
LAMPS

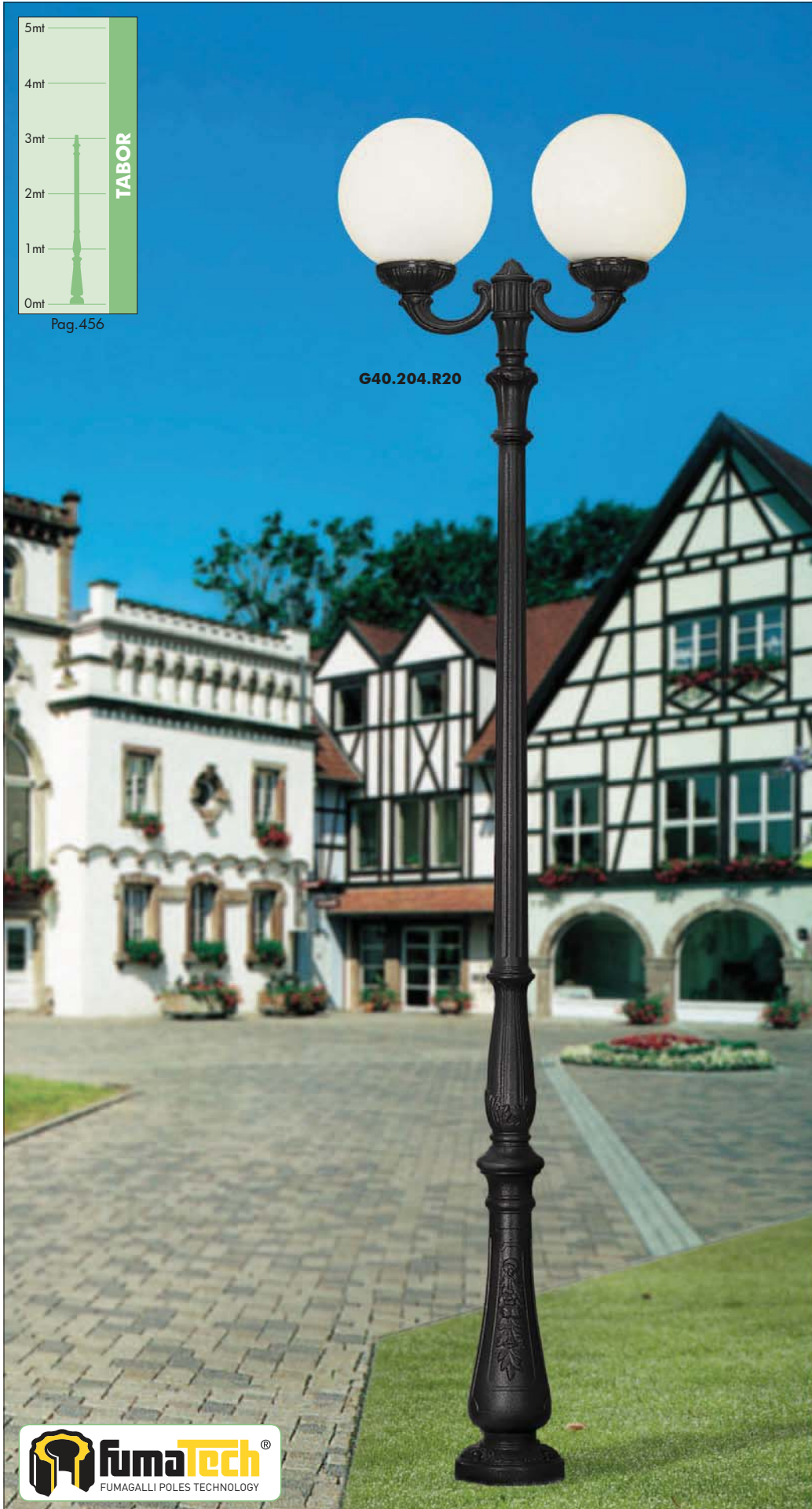

MADE IN ITALY



**OFIR/G400**  
G40.132

Pcs 2  
Kg 5,6  
mc 0,133

**ADAM/G400**  
G40.171

Pcs 2  
Kg 7,2  
mc 0,192

**GLOBE 400 CLASSIC**  
G40.B40

Pcs 2  
Kg 4,2  
mc 0,133

**TABOR/G400**  
G40.204

Pcs 1  
Kg 25,6  
mc 0,230

**TABOR OFIR/G400 2L**  
G40.204.R20

Pcs 1  
Kg 29,4  
mc 0,347

**TABOR OFIR/G400 3L**  
G40.204.R30

Pcs 1  
Kg 32,2  
mc 0,429

**HOEB/GLOBE 400 CLASSIC**  
**LARGE SIZE**

BULKHEAD  
FLOODLIGHT  
IN-GROUND  
BRICKLIGHT  
BOLLARDS  
GARDEN  
URBAN CLASSIC  
URBAN MODERN  
HIGH-BAY  
POST  
LAMPS

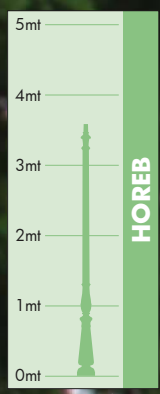



**HOREB ADAM/G400 1L**  
G40.207.M10

Pcs 1  
Kg 29  
mc 0,310

**LOT/G400**  
G40.113

Pcs 2  
Kg 5,6  
mc 0,152

**SICHEM/G400**  
G40.121

Pcs 2  
Kg 5,6  
mc 0,133

**HOREB ADAM/G400 2L**  
G40.207.M20

Pcs 1  
Kg 32,3  
mc 0,378

**HOREB/G400**  
G40.207

Pcs 1  
Kg 27,1  
mc 0,256

**HOREB ADAM/G400 3+1**  
G40.207.M31

Pcs 1  
Kg 40  
mc 0,545

**HOREB ADAM/G400 2+1**  
G40.207.M21

Pcs 1  
Kg 36,1  
mc 0,447

**HOREB ADAM/G400 3L**  
G40.207.M30

Pcs 1  
Kg 37,2  
mc 0,477

BULKHEAD  
FLOODLIGHT  
IN-GROUND  
BRICKLIGHT  
BOLLARDS  
GARDEN  
URBAN CLASSIC  
URBAN/MODERN  
HIGH-BAY  
POST  
LAMPS



KARMEL 3000/**GLOBE 400 CLASSIC**  
LARGE SIZE

BULKHEAD  
FLOODLIGHT  
IN-GROUND  
BRICKLIGHT  
BOLLARDS  
GARDEN  
URBAN CLASSIC  
URBAN MODERN  
HIGH-BAY  
POST  
LAMPS





**KARMEL 3000/G400**  
**G40.231**

Pcs 1  
Kg 26,5  
mc 0,230

Ø 400

3520

Ø 275

**KARMEL 3000 OFIR/G400 2L**  
**G40.231.R20**

Pcs 1  
Kg 29,4  
mc 0,347

920

Ø 400

3620

Ø 275

2

**KARMEL 3000 OFIR/G400 3L**  
**G40.231.R30**

Pcs 1  
Kg 32,2  
mc 0,429

960

Ø 400

3620

Ø 275

3

KARMEL 3500-4000/**GLOBE 400 CLASSIC**  
LARGE SIZE

BULKHEAD  
FLOODLIGHT  
IN-GROUND  
BRICKLIGHT  
BOLLARDS  
GARDEN  
URBAN CLASSIC  
URBAN MODERN  
HIGH-BAY  
POST  
LAMPS

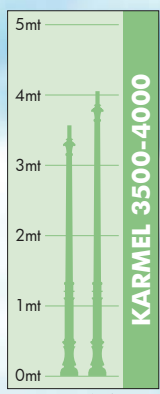

**G40.234.M20**



**G40.171**



**G40.234**



**MADE IN ITALY**



**KARMEL 3500-4000/GLOBE 400**  
**LARGE SIZE**

KARMEL 3500 ADAM/G400 1L	KARMEL 4000 ADAM/G400 1L
G40.234.M10	G40.237.M10
Pcs 1 Kg 29 mc 0,310	Pcs 1 Kg 32,5 mc 0,407

EVA/G400 2L
G40.181
Pcs 1 Kg 10,2 mc 0,353

KARMEL 3500 ADAM/G400 3L	KARMEL 4000 ADAM/G400 3L
G40.234.M30	G40.237.M30
Pcs 1 Kg 37,2 mc 0,477	Pcs 1 Kg 40,7 mc 0,482

KARMEL 3500/G400	KARMEL 4000/G400
G40.234	G40.237
Pcs 1 Kg 27,1 mc 0,256	Pcs 1 Kg 30,6 mc 0,283

KARMEL 3500 ADAM/G400 2+1	KARMEL 4000 ADAM/G400 2+1
G40.234.M21	G40.237.M21
Pcs 1 Kg 36,1 mc 0,420	Pcs 1 Kg 39,6 mc 0,545

KARMEL 3500 ADAM/G400 3+1	KARMEL 4000 ADAM/G400 3+1
G40.234.M31	G40.237.M31
Pcs 1 Kg 40 mc 0,502	Pcs 1 Kg 43,5 mc 0,545

KARMEL 3500 ADAM/G400 2L	KARMEL 4000 ADAM/G400 2L
G40.234.M20	G40.237.M20
Pcs 1 Kg 32,3 mc 0,378	Pcs 1 Kg 35,8 mc 0,400

BULKHEAD  
FLOODLIGHT  
IN-GROUND  
BRICKLIGHT  
BOLLARDS  
GARDEN  
URBAN CLASSIC  
URBAN MODERN  
HIGH-BAY  
POST  
LAMPS

GIONA 4000/**GLOBE 400 CLASSIC**  
LARGE SIZE

BULKHEAD  
FLOODLIGHT  
IN-GROUND  
BRICKLIGHT  
BOLLARDS  
GARDEN  
URBAN CLASSIC  
URBAN MODERN  
HIGH-BAY  
POST  
LAMPS

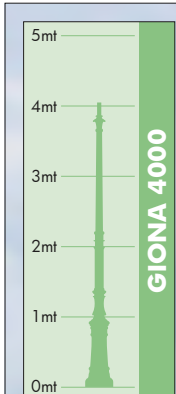

Pag.456





**GIONA 4000 ADAM/G400 1L**  
G40.221.M10

Pcs 1  
Kg 61,31  
mc 0,897

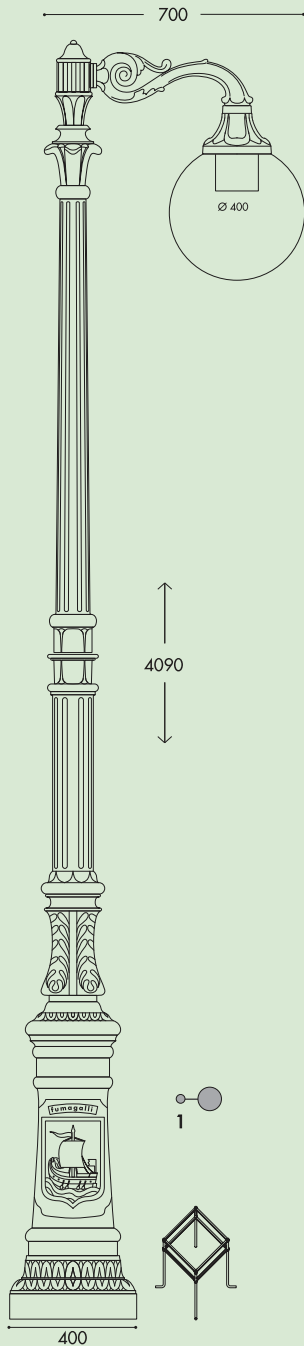

**GIONA 4000 ADAM/G400 3+1**  
G40.221.M31

Pcs 1  
Kg 76,29  
mc 1,32

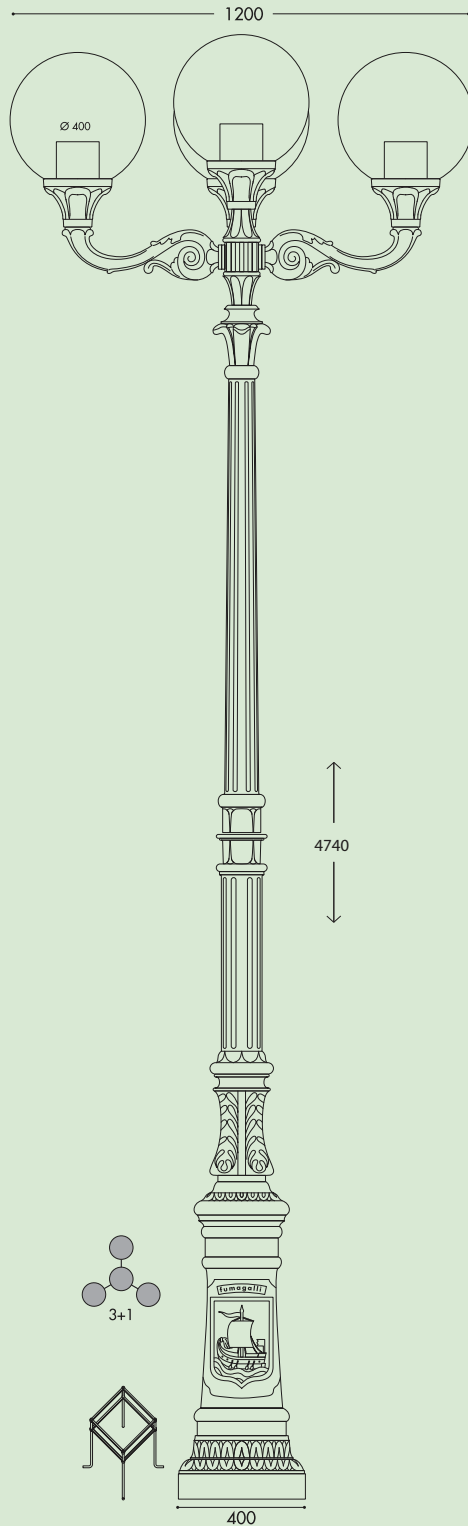

**GIONA 4000 ADAM/G400 2L**  
G40.221.M20

Pcs 1  
Kg 66,78  
mc 0,965

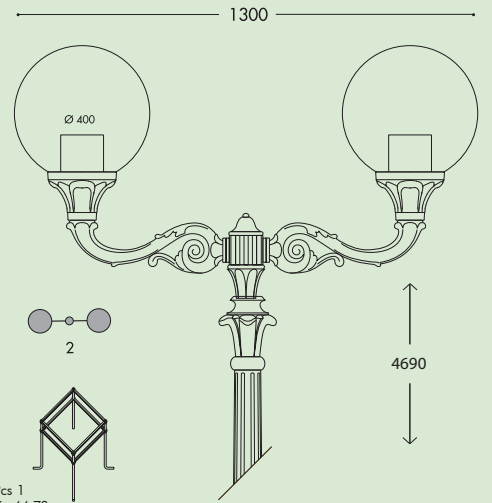

**GIONA 4000 ADAM/G400 2+1**  
G40.221.M21

Pcs 1  
Kg 70,85  
mc 1,034

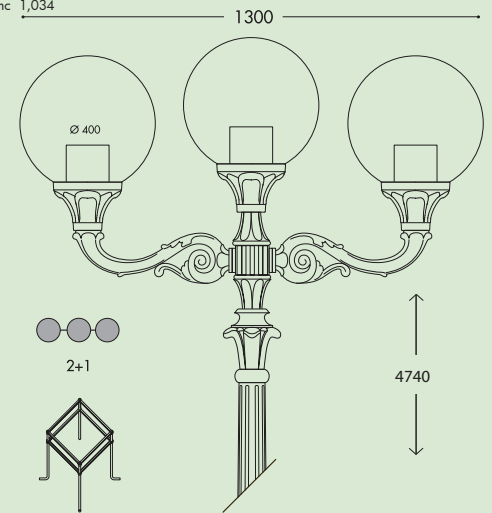

**GIONA 4000 ADAM/G400 3L**  
G40.221.M30

Pcs 1  
Kg 72,29  
mc 1,064

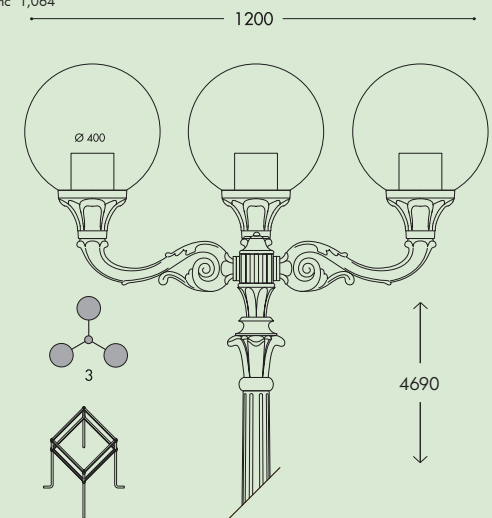

BULKHEAD

FLOODLIGHT

IN-GROUND

BRICKLIGHT

BOLLARDS

GARDEN

URBAN CLASSIC

URBAN/MODERN

HIGH-BAY

POST

LAMPS

# GLOBE 500 CLASSIC

## GRAND SIZE

Ø 500 mm PMMA globe, complete with classic base made of shockproof resin material, UV-rays stabilized, rust and corrosion-free. Suitable for post top, hanging and wall installation. Provided with E27 lampholder and prepared for ballast and louvre fixation. Insulation class II, protection rating IP65.

*Globo Ø 500 mm in polimetilmetacrilato (PMMA) completo di base classica realizzata in resina antiurto, stabilizzata ai raggi UV, inattaccabile da ruggine e corrosione. Idoneo per il montaggio a palo, a sospensione o a parete. Fornito con portalampada E27 e predisposto per il fissaggio dei reattori e del frangiluce. Classe di isolamento II, grado di protezione IP65.*



BULKHEAD

FLOODLIGHT

IN-GROUND

BRICKLIGHT

BOLLARDS

GARDEN











URBAN CLASSIC

URBAN MODERN

HIGH-BAY

POST

LAMPS

**GLOBE 500 CLASSIC - COMPONENTS**

**IP65**



**500 mm GLOBE** made of UV-rays stabilized polymethylmethacrylate (PMMA), one piece only. Available in clear, opal or smoked colour.

**GLOBO Ø 500 mm Ø 500 mm in polimetilmacrilato (PMMA), resistente all'ingiallimento ed ai raggi UV, realizzato in un unico pezzo. Disponibile nei colori trasparente, bianco o fumé.**

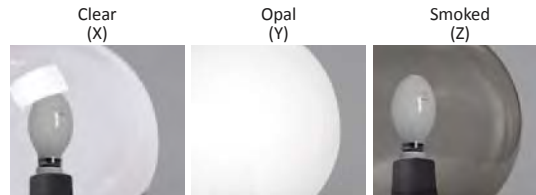

Chrome aluminium **LOUVRE** with a laminar symmetrical optic system to direct the lighting output and to get a lower dazzle (optional).

**FRANGILUCE** in alluminio cromato con sistema ottico lamellare a ripartizione simmetrica per orientare il fascio di luce e ridurre l'abbagliamento (opzionale).

Luminaries **BASE**, made of shockproof resin material, UV-rays stabilized, rust and corrosion-free, consisting of a support and of a cover suitable for electrical accessories fixation on its lower side and provided with E27 - E40 lampholder on its upper side.

A rubber gasket assures the protection of the electrical accessories seat from external agents.

**BASE del globo, realizzata in resina antiurto, stabilizzata ai raggi UV, inattaccabile da ruggine e corrosione. Composta da un supporto e da un coperchio nella cui parte inferiore possono essere fissati gli accessori elettrici e nella cui parte superiore si trova l'alloggiamento per il portalampada E27 (incluso). Una guarnizione in gomma garantisce la protezione dell'alloggiamento degli accessori elettrici dagli agenti esterni.**

**GLOBE 500 CLASSIC**

G50.B50 \*

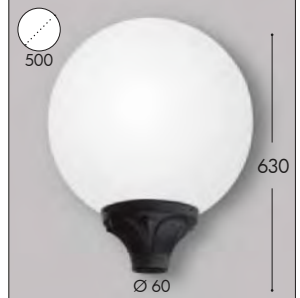

**Dimensions and weight**

Height: 630 mm  
Diameter: 500 mm  
Junction to support: diameter 60 mm  
Weight: 3,5 Kg  
Area exposed to wind pressure: CxS = m<sup>2</sup> 0,181

**Moulded colours:**

Black   White

**Painted colours:**

Antique green   Antique bronze

**Diffuser PMMA:**

Clear   Opal   Smoked

**CHROME ALUMINIUM LOUVRE**

H.FC1 closed  
Upward position



H.FC6 open  
Downward position



\* ADD THE ABOVE SUFFIXES TO THE REFERENCES MENTIONED IN THE CATALOGUE

**E27**

\*ADD. SUFFIX

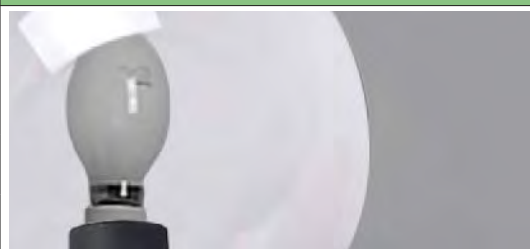

Globe complete with classic base and **E27** or **E40** lampholder. Provided as an option with ballast kit for SON-HQI.

<b>E27</b> (GLS-CFL-LED)	E27 Lampholder only	.E27
<b>E27</b> WITH BALLAST KIT	SON 70W	.S70
	HQI 70W	.H70
<b>E40</b> WITH BALLAST KIT	SON 100W	.S10
	HQI 100W	.H10

**PHOTOMETRIC DATA SAMPLE**

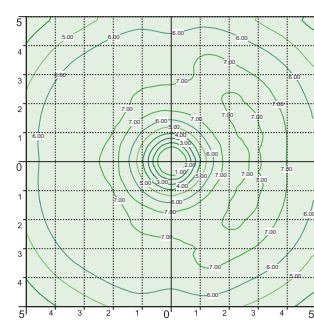
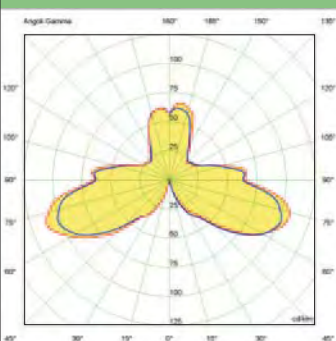

**GLOBE 500 CLASSIC** clear SON 70W (with louvre).

POST height 3,5mt  
10 x 10mt area: average 6 lux

The photometric data for all the versions are available upon request or on our website.



**GLOBE 500 CLASSIC**  
GRAND SIZE

BULKHEAD  
FLOODLIGHT  
IN-GROUND  
BRICKLIGHT  
BOLLARDS  
GARDEN  
URBAN CLASSIC  
URBAN MODERN  
HIGH-BAY  
POST  
LAMPS



MADE IN  
ITALY

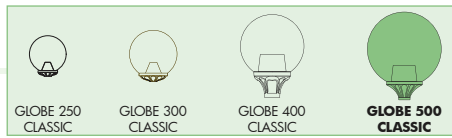

**GIONA 5000/G500**  
G50.227

Pcs 1  
Kg 60,5  
mc 1,157

Ø 500

5500

400

<b>GIONA 4000/G500</b> G50.221	<b>GIONA 4500/G500</b> G50.224
Pcs 1 Kg 54,5 mc 0,907	Pcs 1 Kg 57,5 mc 1,027

Ø 500

5000  
4500

400

<b>KARMEL 3500/G500</b> G50.234	<b>KARMEL 4000/G500</b> G50.237
Pcs 1 Kg 28,5 mc 0,447	Pcs 1 Kg 32 mc 0,498

Ø 500

4500  
4000

Ø 275

**SICHEM/G500**  
G50.121

Pcs 2  
Kg 15  
mc 0,275

Ø 500

1050

**GLOBE 500 CLASSIC**  
G50.B50

Pcs 2  
Kg 7  
mc 0,275

Ø 500

630

Ø 60

<b>TABOR/G500</b> G50.204	<b>HOREB/G500</b> G50.207
Pcs 1 Kg 27 mc 0,407	Pcs 1 Kg 28,5 mc 0,447

Ø 500

4000  
3500

Ø 275

**KARMEL 3000/G500**  
G50.231

Pcs 1  
Kg 27  
mc 0,407

Ø 500

3500

Ø 275

GIONA 4500-5000/**GLOBE 500 CLASSIC**  
GRAND SIZE

BULKHEAD  
FLOODLIGHT  
IN-GROUND  
BRICKLIGHT  
BOLLARDS  
GARDEN  
URBAN CLASSIC  
URBAN MODERN  
HIGH-BAY  
POST  
LAMPS



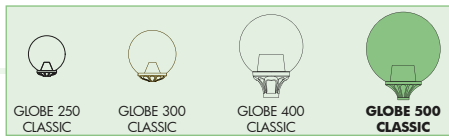

**GIONA 4500 ARON/G500 1L**    **GIONA 5000 ARON/G500 1L**  
G50.224.N10    G50.227.N10

Pcs 1    Pcs 1  
Kg 61    Kg 64  
mc 1,031    mc 1,146

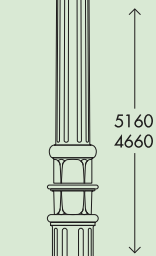
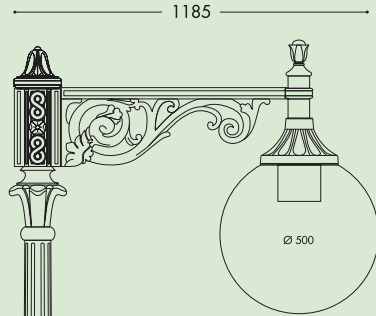

400

**ARON/G500**  
G50.172

Pcs 1  
Kg 6,5  
mc 0,178

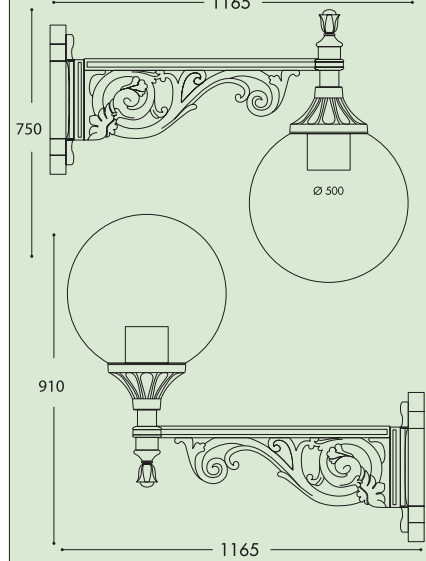

**LOT/G500**  
G50.113

Pcs 2  
Kg 16  
mc 0,275

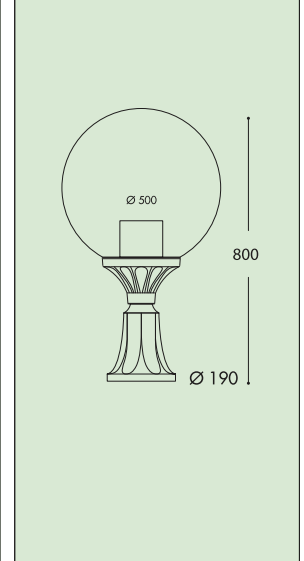

**GIONA 4500 ARON/G500 2L**    **GIONA 5000 ARON/G500 2L**  
G50.224.N20    G50.227.N20

Pcs 1    Pcs 1  
Kg 66    Kg 69  
mc 1,115    mc 1,239

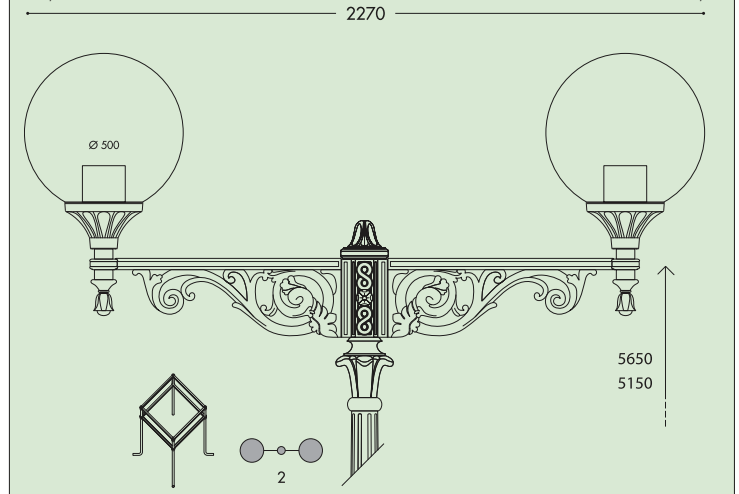

**ERMON.R/G500**  
G50.195 resin

Pcs 1    500  
Kg 8,5  
mc 0,212

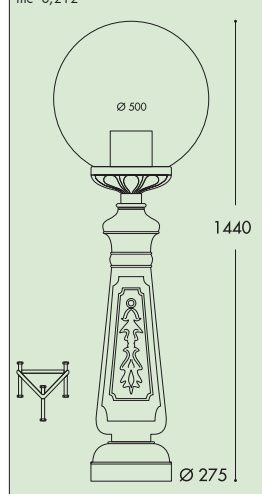

**GIONA 4500 ARON/G500 4L**    **GIONA 5000 ARON/G500 4L**  
G50.224.N40    G50.227.N40

Pcs 1    Pcs 1  
Kg 76    Kg 79  
mc 1,282    mc 1,425

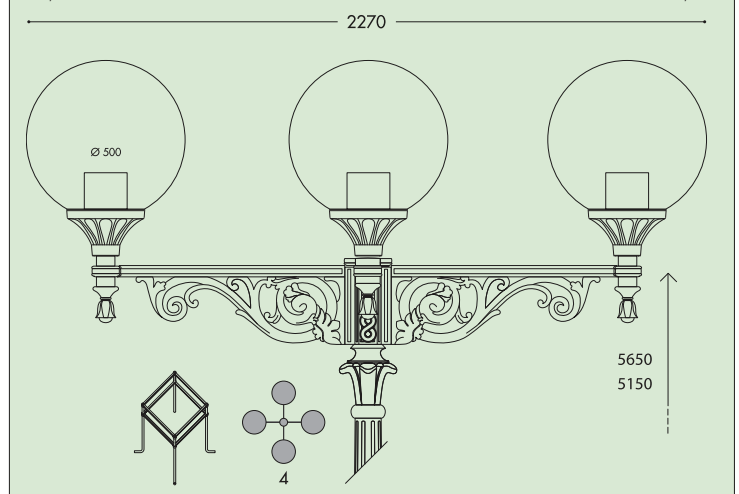

# CANA 500

## GRAND SIZE

PMMA amphora, complete with classic base made of shockproof resin material, UV-rays stabilized, rust and corrosion-free. Suitable for post top or wall installation. Provided with E27 lampholder and prepared for ballast and louvre fixation. Insulation class II, protection rating IP65.

*Anfora in polimetilmetacrilato (PMMA) completo di base classica realizzata in resina antiurto, stabilizzata ai raggi UV, inattaccabile da ruggine e corrosione. Idoneo per il montaggio a palo o a parete. Fornito con portalampada E27 e predisposto per il fissaggio dei reattori e del frangiluce. Classe di isolamento II, grado di protezione IP65.*



BULKHEAD  
FLOODLIGHT  
IN-GROUND  
BRICKLIGHT  
BOLLARDS  
GARDEN  
URBAN CLASSIC  
URBAN MODERN  
HIGH-BAY  
POST  
LAMPS

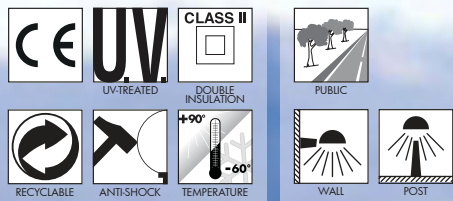

**CANA 500 - COMPONENTS**

**IP65**



Classic **AMPHORA** made of UV-rays stabilized polymethylmethacrylate (PMMA), one piece only. Available in clear, opal or smoked colour.

**ANFORA** in stile classico in polimetilmetacrilato (PMMA), resistente all'ingiallimento ed ai raggi UV, realizzato in un unico pezzo. Disponibile nei colori trasparente, bianco o fumé.

Chrome aluminium **LOUVRE** with a laminar symmetrical optic system to direct the lighting output and to get a lower dazzle (optional).

**FRANGILUCE** in alluminio cromato con sistema ottico lamellare a ripartizione simmetrica per orientare il fascio di luce e ridurre l'abbagliamento (opzionale).

**BASE**, made of shockproof resin material, UV-rays stabilized, rust and corrosion-free, consisting of a support and of a cover suitable for ballast kit fixation on its lower side and provided with E27 lampholder on its upper side. A rubber gasket assures the protection of the electrical accessories seat against external agents.

**BASE** realizzata in resina antiurto, stabilizzata ai raggi UV, inattaccabile da ruggine e corrosione. Composta da un supporto e da un coperchio nella cui parte inferiore possono essere fissati gli accessori elettrici e nella cui parte superiore si trova l'alloggiamento per il portalampada E27 (incluso). Una guarnizione in gomma garantisce la protezione dell'alloggiamento degli accessori elettrici dagli agenti esterni.

**CANA 500**

C50.B50 \*



**Dimensions and weight**

Height: 690 mm  
Diameter: 400 mm  
Junction to support: diameter 60 mm  
Weight: 3,4 Kg  
Area exposed to wind pressure:  
CxS = m<sup>2</sup> 0,122

**Moulded colours:**

Black  White

**Painted colours:**

Antique green  Antique bronze

**Diffuser PMMA:**

Clear  Opal

**CHROME ALUMINIUM LOUVRE**

H.FC1 closed  
Upward position



**E27**

\*ADD. SUFFIX

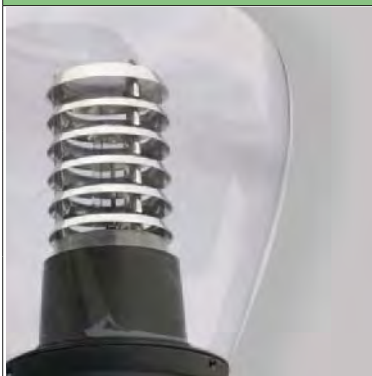

Amphora complete with classic base and <b>E27</b> lampholder. Provided as an option with ballast kit for SON-HQI.	<b>E27</b> (GLS-CFL-LED)	E27 lampholder only	.E27
	<b>E27</b> WITH BALLAST KIT	SON 70W	.S70
		HQI 70W	.H70

\* ADD THE ABOVE SUFFIXES TO THE REFERENCES MENTIONED IN THE CATALOGUE

**PHOTOMETRIC DATA SAMPLE**

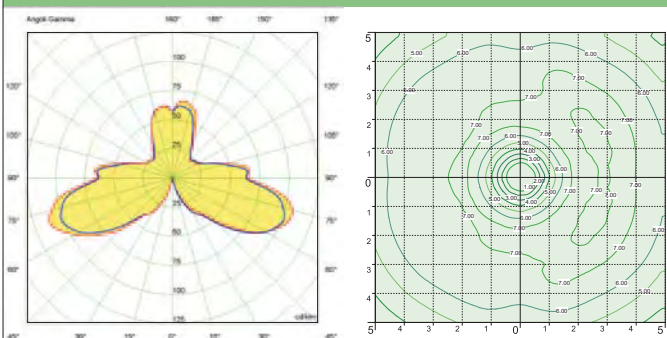

**CANA 500** clear SON 70W (with louvre).

POST height 3,5mt  
10 x 10mt area: average 6 lux

The photometric data for all the versions are available upon request or on our website.

KARMEL 3500-4000/**CANA 500**  
GRAND SIZE

BULKHEAD  
FLOODLIGHT  
IN-GROUND  
BRICKLIGHT  
BOLLARDS  
GARDEN  
URBAN CLASSIC  
URBAN MODERN  
HIGH-BAY  
POST  
LAMPS

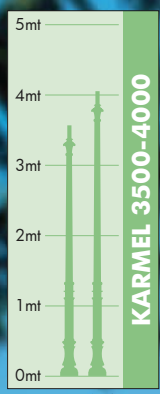

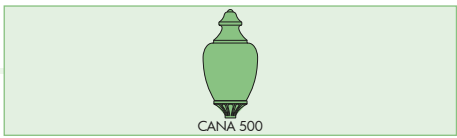

BULKHEAD  
FLOODLIGHT  
IN-GROUND  
BRICKLIGHT  
BOLLARDS  
GARDEN  
URBAN CLASSIC  
URBAN/MODERN  
HIGH-BAY  
POST  
LAMPS

**LOT/CANA 500**  
**C50.113**

Pcs 1  
Kg 16  
mc 0,200

400  
930  
Ø 190

**ADAM/CANA 500**  
**C50.171**

Pcs 1  
Kg 4,9  
mc 0,187

635  
800

**KARMEL 3500 ADAM/ KARMEL 4000 ADAM/ CANA 500 2L**  
**C50.234.M20** **C50.237.M20**

Pcs 1  
Kg 35,1  
mc 0,446

Pcs 1  
Kg 38,7  
mc 0,468

1300  
4790  
4290

2

**KARMEL 3500/ CANA 500** **KARMEL 4000/ CANA 500**  
**C50.234** **C50.237**

Pcs 1  
Kg 28,5  
mc 0,320

Pcs 1  
Kg 32  
mc 0,371

400  
4170  
Ø 275

**KARMEL 3500 ADAM/ KARMEL 4000 ADAM/ CANA 500 2+1**  
**C50.234.M21** **C50.237.M21**

Pcs 1  
Kg 38,8  
mc 0,522

Pcs 1  
Kg 42,3  
mc 0,647

1300  
4850  
4350  
Ø 275

2+1

**KARMEL 3500 ADAM/ KARMEL 4000 ADAM/ CANA 500 3L**  
**C50.234.M30** **C50.237.M30**

Pcs 1  
Kg 39,7  
mc 0,579

Pcs 1  
Kg 43,2  
mc 0,584

1270  
4790  
4290

3

**KARMEL 3500 ADAM/ KARMEL 4000 ADAM/ CANA 500 3+1**  
**C50.234.M31** **C50.237.M31**

Pcs 1  
Kg 43,4  
mc 0,638

Pcs 1  
Kg 46,9  
mc 0,681

1270  
4850  
4350  
Ø 275

3+1



GIONA 4000/**CANA 500**  
GRAND SIZE

BULKHEAD  
FLOODLIGHT  
IN-GROUND  
BRICKLIGHT  
BOLLARDS  
GARDEN  
URBAN CLASSIC  
URBAN MODERN  
HIGH-BAY  
POST  
LAMPS

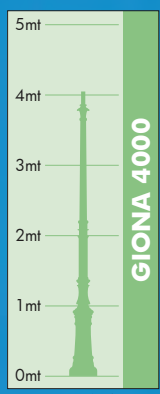

MADE IN ITALY



**GIONA 4000/CANA 500**  
C50.221

Pcs 1  
Kg 54,5  
mc 0,780

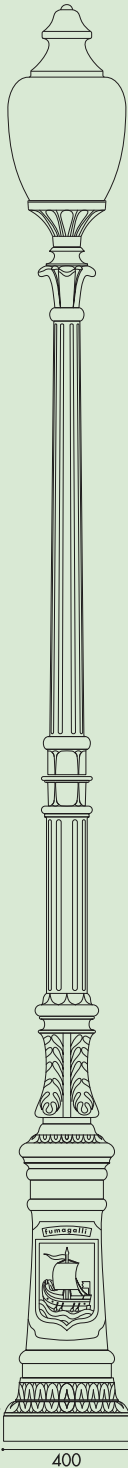

**GIONA 4000 ADAM/CANA 500 3L**  
C50.221.M30

Pcs 1  
Kg 65,7  
mc 0,854

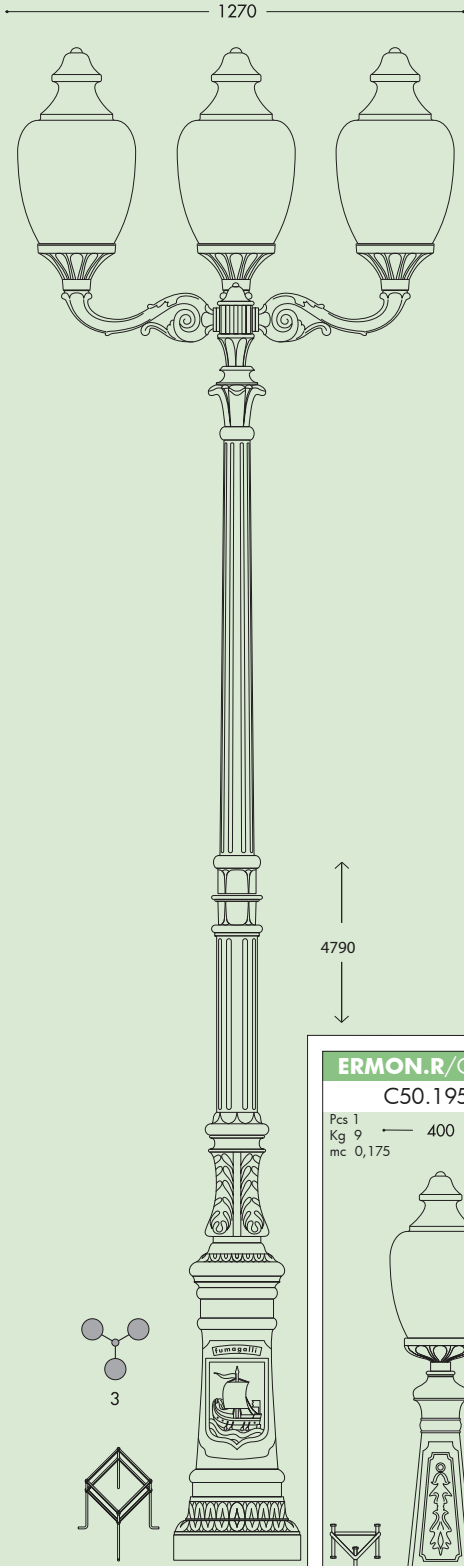

**GIONA 4000 ADAM/CANA 500 2L**  
C50.221.M20

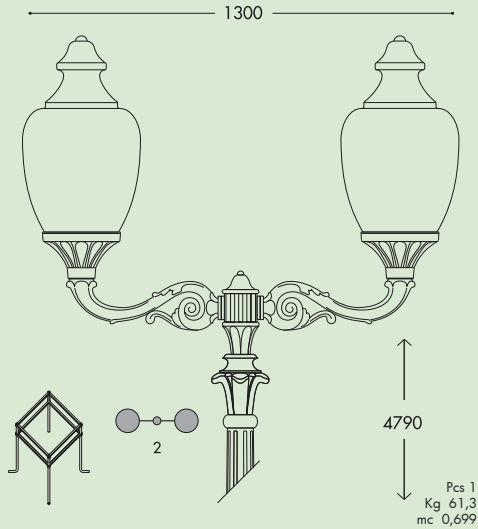

**GIONA 4000 ADAM/CANA 500 2+1**  
C50.221.M21

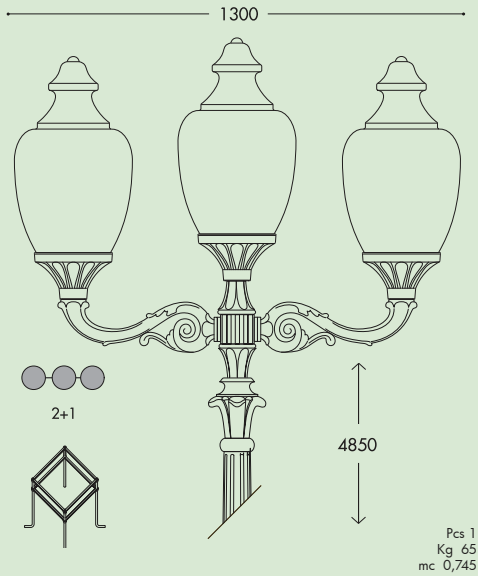

**ERMON.R/CANA 500**  
C50.195 resin

Pcs 1  
Kg 9  
mc 0,175

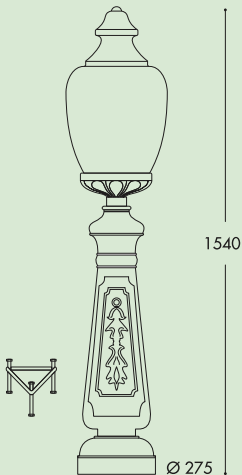

**GIONA 4000 ADAM/CANA 500 3+1**  
C50.221.M31

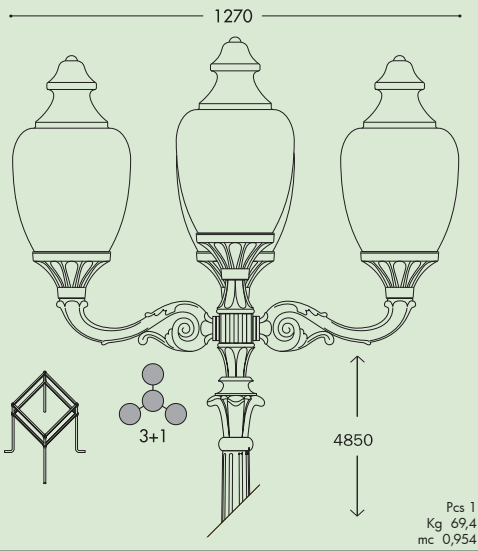

BULKHEAD  
FLOODLIGHT  
IN-GROUND  
BRICKLIGHT  
BOLLARDS  
GARDEN  
URBAN CLASSIC  
URBAN MODERN  
HIGH-BAY  
POST  
LAMPS

	LAMPS
	POST
	HIGH-BAY
	URBAN MODERN
	URBAN CLASSIC
	GARDEN
	BOLLARDS
	BRICKLIGHT
	IN-GROUND
	FLOODLIGHT
	BULKHEAD

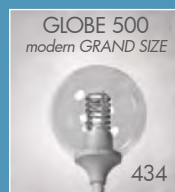

# URBAN MODERN

BULKHEAD

FLOODLIGHT

IN-GROUND

BRICKLIGHT

BOLLARDS

GARDEN

URBAN CLASSIC

HIGH-BAY

POST

LAMPS

# GIORGIO/ROSA FLOODLIGHT

BULKHEAD  
FLOODLIGHT  
IN-GROUND  
BRICKLIGHT  
BOLLARDS  
GARDEN  
URBAN CLASSIC  
URBAN MODERN  
HIGH-BAY  
POST  
LAMPS

Post top system complete with single or double luminaires made in in shockproof resin material, UV-rays stabilized, rust and corrosion-free. The provided bracket allows a fully adjustable floodlight position to direct the light emission. Supplied with TÜV approved, long-life and efficient GX53 LED lamps included or provided with 2x E27 lampholders. Insulation class II, Protection rating IP66.

*Sistema completo di diffusori per installazioni a palo con luce singola o doppia. Fabbricato in resina antiurto stabilizzata ai raggi UV, inattaccabile da ruggine e corrosione. Il braccio in dotazione permette l'inclinazione e l'orientamento del proiettore per direzionare il flusso luminoso. Provvisto di lampadine a LED GX53 approvate TÜV di lunga durata ed elevata efficienza o fornito nella versione 2x E27. Classe di isolamento II, grado di protezione IP66.*



GIORGIO  
4P2.000.G10  
4P1.000.G10

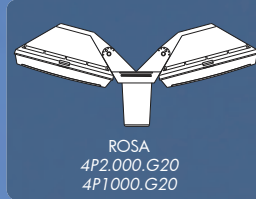

ROSA  
4P2.000.G20  
4P1000.G20



4P2.000.G10



4P2.000.G20

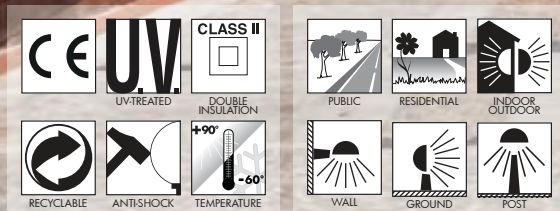

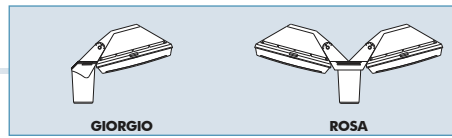

**GIORGIO/ROSA - COMPONENTS**

**IP66**



Square **FLOODLIGHT** with no visible screws made in shockproof resin material, UV-rays stabilized, rust and corrosion-free. Supplied with TÜV approved, long-life and efficient GX53 LED lamps included or provided with 2x E27 lampholders.

***PROIETTORE** quadro senza viti a vista, fabbricato in resina antiurto stabilizzata ai raggi UV, inattaccabile da ruggine e corrosione. Provvisto di lampadine a LED GX53 approvate TÜV di lunga durata ed elevata efficienza o fornito nella versione 2x E27.*

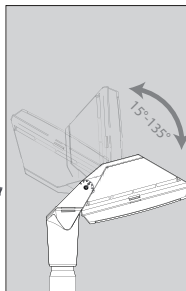

**POST TOP SYSTEM** with single or double bracket made in shockproof resin material, UV-rays stabilized. The provided bracket allows a fully adjustable position of the floodlight to direct at will the light emission.

**SISTEMA A PALO** con braccio singolo o doppio realizzato in resina antiurto, stabilizzata ai raggi UV. Il braccio permette l'orientamento in qualsiasi posizione del proiettore per poter direzionare il flusso luminoso.

**GIORGIO**

4P2.000.G10 \*



**Dimensions and weight**

Height: 200 mm  
Width: 420 mm  
Weight: 3 Kg

**ROSA**

4P2.000.G20 \*



**Dimensions and weight**

Height: 200 mm  
Width: 700 mm  
Weight: 5 Kg

**Moulded Colours:**

Black     Grey     White

**Diffuser PMMA:**

Opal     Frosted (upon request)



**4x GX53 LED**

FULLY PRE-WIRED



4P2.000.G10 / 4P2.000.G20

Floodlight supplied with white resin reflective ceiling complete with TÜV approved long-life and efficient **4x GX53 LED lamps included**. Different wattages available. Quick and easy lamp replacement for a very simple maintenance after installation.

				*ADD. SUFFIX	
	4x 7W <b>28W</b>	<b>3200 Lm</b>	4000 K	.C4L	
			3000 K	.C4R	
	4x 10W <b>40W</b>	<b>4800 Lm</b>	4000 K	.D4L	
			3000 K	.D4R	

 **4x 10W = 100W**  
**4800 Lm**      **SON-HQI**

**SAVE 60%**

**GX53 LED**

FULLY PRE-WIRED



4P1.000.G10 / 4P1.000.G20

Floodlight supplied **fully pre-wired** and complete with TÜV approved, long-life and efficient **GX53 LED lamp** in different wattages. Quick and easy lamp replacement for a very simple maintenance after installation. Sensor available as option.

				*ADD. SUFFIX	
	<b>11 W</b>	<b>1300 Lm</b>	4000 K	.B1L	
			3000 K	.B1R	
	<b>18 W</b>	<b>2000 Lm</b>	4000 K	.E1L	
			3000 K	.E1R	

 **11W = 100W**  
**18W = 150W**      **incandescent**

**SAVE 90%**



**2x E27**

FULLY PRE-WIRED



4P2.000.G10 / 4P2.000.G20

Floodlight supplied **fully pre-wired** with white resin reflective ceiling and complete with **2x E27 lampholders**. Daylight and motion sensor available as option. Sensor operating voltage: 220-240V. (120V version available on demand).

		*ADD. SUFFIX	
	<b>2x E27 (CFL-LED)</b>	max 160 mm	.E28
		↔	
	<b>2x E27 + SENSOR</b>	max 160 mm	.ES8
		↔	

**LED LAMPS**

More technical details about TÜV approved Fumagalli LED Lamps on page 468.



\* ADD THESE SUFFIXES TO THE REFERENCES MENTIONED IN THE CATALOGUE

# GIORGIO/ROSA - EKTOR FLOODLIGHT

BULKHEAD  
FLOODLIGHT  
IN-GROUND  
BRICKLIGHT  
BOLLARDS  
GARDEN  
URBAN CLASSIC  
URBAN MODERN  
HIGH-BAY  
POST  
LAMPS



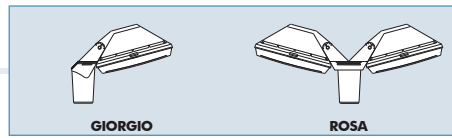

**GIORGIO**

4P1.000.G10.B1L	<b>11W</b>	4P1.000.G10.B1R
4P1.000.G10.E1L	<b>18W</b>	4P1.000.G10.E1R
4P2.000.G10.C4L	<b>28W</b>	4P2.000.G10.C4R
4P2.000.G10.D4L	<b>40W</b>	4P2.000.G10.D4R

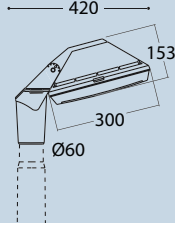

Pcs 1  
Kg 3  
mc 0,029

<b>2x E27</b>	4P2.000.G10.E28
<b>2x E27 with sensor</b>	4P2.000.G10.ES8

**ROSA**

4P1.000.G20.B1L	<b>2x 11W</b>	4P1.000.G20.B1R
4P1.000.G20.E1L	<b>2x 18W</b>	4P1.000.G20.E1R
4P2.000.G20.C4L	<b>2x 28W</b>	4P2.000.G20.C4R
4P2.000.G20.D4L	<b>2x 40W</b>	4P2.000.G20.D4R

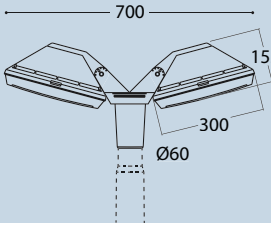

Pcs 1  
Kg 5  
mc 0,049

<b>2x E27</b>	4P2.000.G20.E28
<b>2x E27 with sensor</b>	4P2.000.G20.ES8

**GIOVA/GIUSEPPE**

4P1.702.B1L	<b>11W</b>	4P1.702.B1R
4P1.702.E1L	<b>18W</b>	4P1.702.E1R
4P2.702.C4L	<b>28W</b>	4P2.702.C4R
4P2.702.D4L	<b>40W</b>	4P2.702.D4R

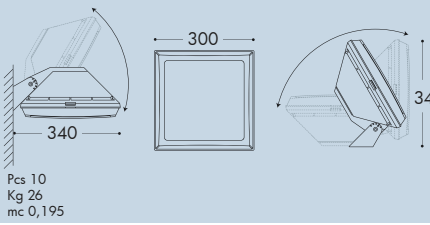

Pcs 10  
Kg 26  
mc 0,195

<b>2x E27</b>	4P2.702.E28
<b>2x E27 with sensor</b>	4P2.702.ES8

**EKTOR 3500/GIORGIO**    **EKTOR 4000/GIORGIO**

4P2.367.G10	4P2.371.G10
-------------	-------------

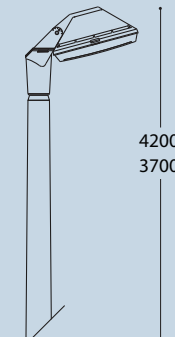

Pcs 1  
Kg 36  
mc 0,214

Pcs 1  
Kg 39  
mc 0,240

**EKTOR 2500/ROSA**    **EKTOR 3000/ROSA**

4P2.361.G20	4P2.364.G20
-------------	-------------

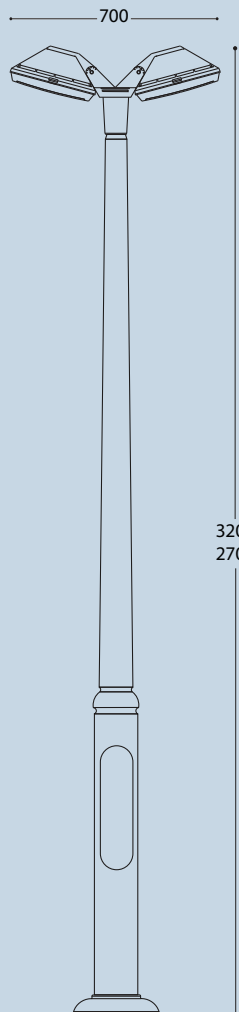

Pcs 1  
Kg 25  
mc 0,181

Pcs 1  
Kg 35  
mc 0,208

**EKTOR 3500/ROSA**    **EKTOR 4000/ROSA**

4P2.367.G20	4P2.371.G20
-------------	-------------

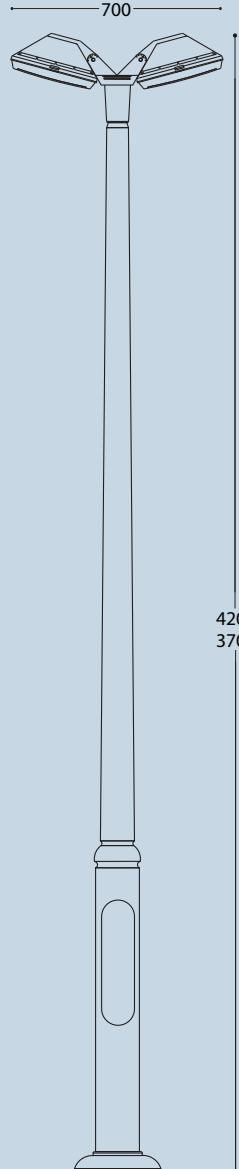

Pcs 1  
Kg 38  
mc 0,234

Pcs 1  
Kg 41  
mc 0,260

**EKTOR 2500/GIORGIO**    **EKTOR 3000/GIORGIO**

4P2.361.G10	4P2.364.G10
-------------	-------------

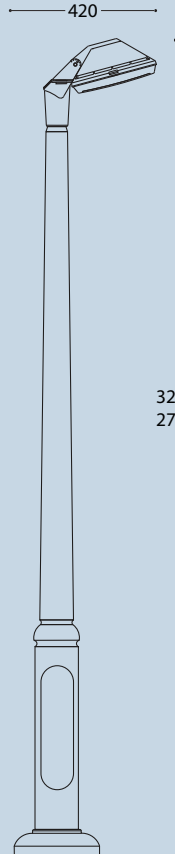

Pcs 1  
Kg 23  
mc 0,161

Pcs 1  
Kg 33  
mc 0,188

**EKTOR 2500/ROSA**    **EKTOR 3000/ROSA**

4P2.361.G20	4P2.364.G20
-------------	-------------

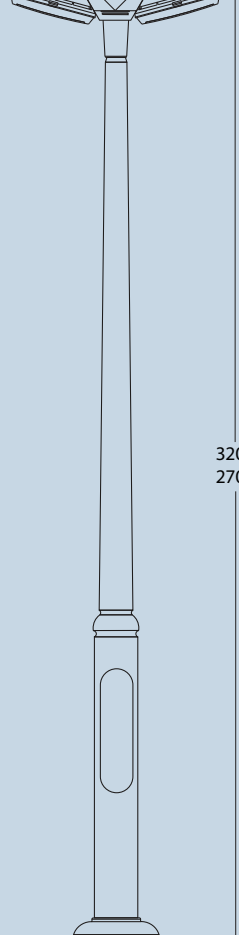

Pcs 1  
Kg 25  
mc 0,181

Pcs 1  
Kg 35  
mc 0,208

**EKTOR 3500/ROSA**    **EKTOR 4000/ROSA**

4P2.367.G20	4P2.371.G20
-------------	-------------

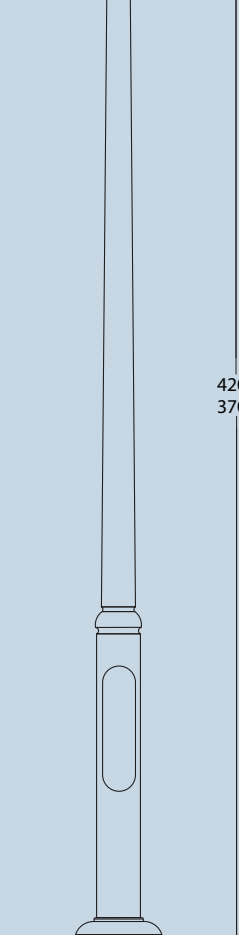

Pcs 1  
Kg 38  
mc 0,234

Pcs 1  
Kg 41  
mc 0,260



# GIORGIO/ROSA - AKILLE FLOODLIGHT

BULKHEAD  
FLOODLIGHT  
IN-GROUND  
BRICKLIGHT  
BOLLARDS  
GARDEN  
URBAN CLASSIC  
URBAN MODERN  
HIGH-BAY  
POST  
LAMPS

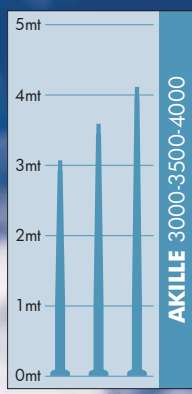
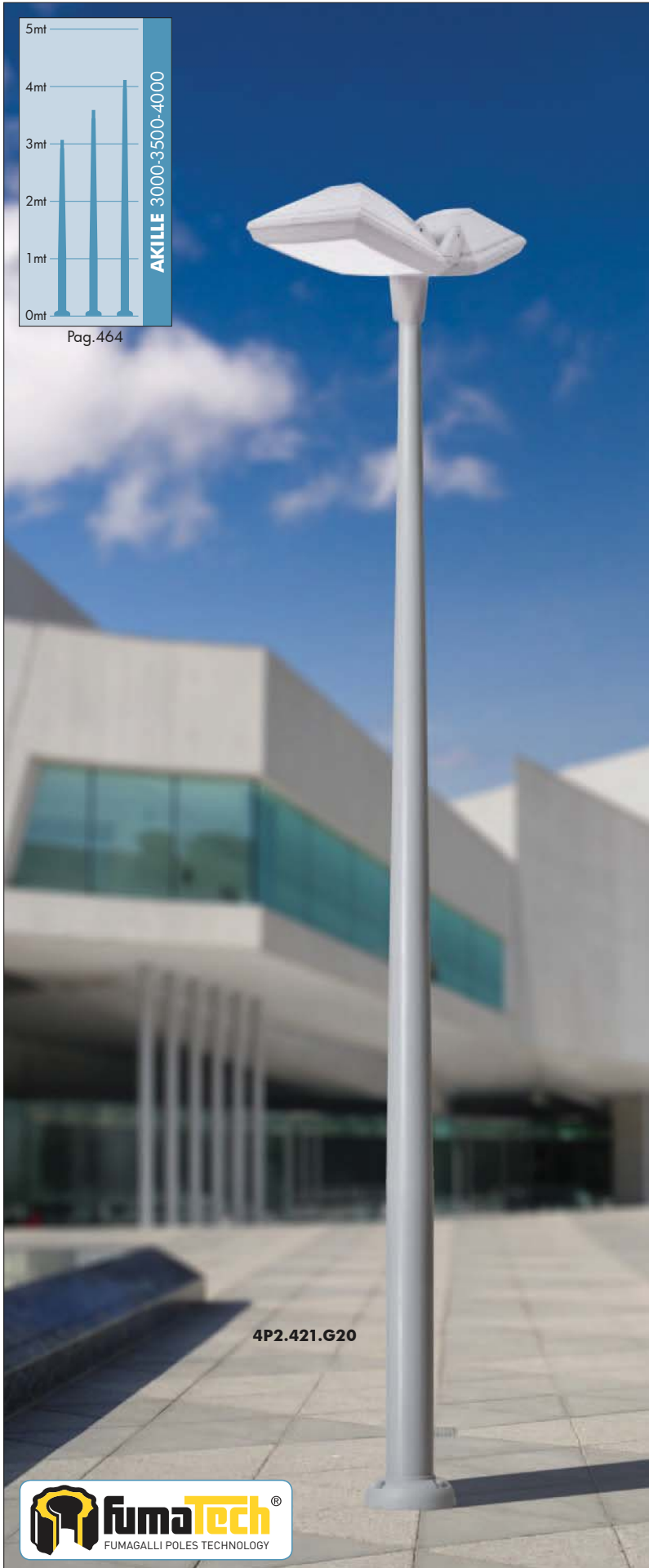

Pag.464

4P2.421.G20



4P2.417.G10



4P2.414.G20



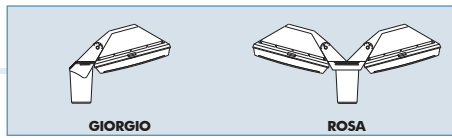

**AKILLE 3000/GIORGIO**  
4P2.414.G10

Pcs 1  
Kg 33  
mc 0,188

420

3200

**AKILLE 3500/GIORGIO**  
4P2.417.G10

Pcs 1  
Kg 36  
mc 0,214

420

3700

**AKILLE 4000/GIORGIO**  
4P2.421.G10

Pcs 1  
Kg 39  
mc 0,240

420

4200

**AKILLE 3000/ROSA**  
4P2.414.G20

Pcs 1  
Kg 35  
mc 0,208

700

3200

Ø 265

**AKILLE 3500/ROSA**  
4P2.417.G20

Pcs 1  
Kg 38  
mc 0,234

700

3700

Ø 265

**AKILLE 4000/ROSA**  
4P2.421.G20

Pcs 1  
Kg 41  
mc 0,260

700

4200

Ø 265

# ECOVIVI 400

## LARGE SIZE

Modern luminaries made of shockproof resin material, UV-rays stabilized, rust and corrosion-free. Suitable for post top, wall and hanging installation. Supplied with flat diffuser granting no upward light emission. Provided with high temperature resistant ceiling suitable for horizontal bulb fixation and with aluminum reflector to optimize the light distribution. Designed according to the international regulations against light pollution (standard UNI 10819 - Installation area: Zone 1). Insulation class II, Protection rating IP65.

*Diffusore moderno realizzato in resina antiurto, stabilizzato ai raggi UV, inattaccabile da ruggine e corrosione. Idoneo per il montaggio a palo, a sospensione o a parete. Fornito con diffusore piatto per garantire assenza di emissioni di luce verso l'alto. Provvisto di soffitto ad alta resistenza al calore idoneo per il fissaggio orizzontale della lampadina e completo di parabola riflettente in alluminio per direzionare il flusso luminoso. Progettato in ottemperanza alle norme internazionali contro l'inquinamento luminoso (standard UNI 10819 - Area di installazione: Zona 1). Classe di isolamento II, grado di protezione IP65.*





### ECOVIVI 400 E27 VERSION - COMPONENTS

IP65

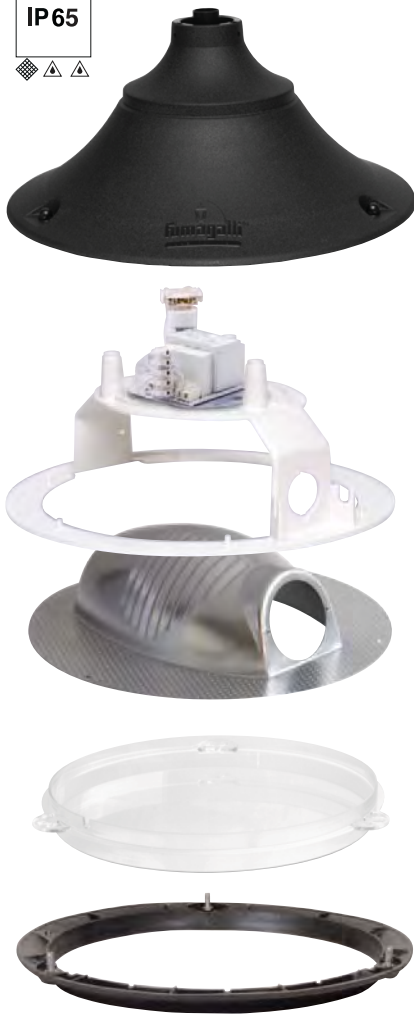

**ROOF** made of shockproof resin material, UV-rays stabilized, rust and corrosion-free.

**TETTO** realizzato in resina antiurto, stabilizzata ai raggi UV, inattaccabile da ruggine e corrosione.

High temperature resistant **CEILING** made of white polycarbonate (PC), UV-rays stabilized, suitable for ballast fixation on its upper side and provided with E27 or E40 lampholder on its lower side. Bulb in horizontal position.

**SOFFITTO** realizzato in policarbonato bianco (PC) ad alta resistenza al calore, stabilizzato ai raggi UV, nella cui parte superiore vengono fissati i reattori. Fornito completo di portalampada E27 o E40 atto a sostenere la lampadina in posizione orizzontale.

Parabolic **REFLECTOR** made of anodized aluminium, designed to optimize the light distribution and to limit the skyward dispersion of the luminous flux.

**PARABOLA** riflettente realizzata in alluminio anodizzato, progettata per ottimizzare la distribuzione del flusso luminoso e limitarne la dispersione verso il cielo.

**DIFFUSER** with flat shape to avoid the skyward dispersion of the luminous flux, according to the international regulations against light pollution and in particular the standard UNI 108119. Made of UV-rays stabilized polycarbonate (PC) and available in clear and opal colour.

**DIFFUSORE** con configurazione piatta per evitare la dispersione verso il cielo del flusso luminoso, in ottemperanza alle norme internazionali sull'inquinamento luminoso ed in particolare la norma UNI 10819. Realizzato in policarbonato (PC) stabilizzato ai raggi UV e disponibile in colore trasparente o opale.

Decorative connection **RING** to be fixed on the luminaries diffuser.

**ANELLO** decorative di connessione da fissare sul diffusore dell'apparecchio.

### ECOVIVI 400 E27

EV4.000 \*



#### Dimensions and weight

Height: 243 mm  
Diameter: 480 mm  
Weight: 4,7 Kg  
Junction to support: diameter 60 mm  
Area expose to wind pressure:  
CxS = m<sup>2</sup> 0,1449

#### Moulded colours:

Black White Grey

#### Diffuser PC (UV treated):

Clear Opal

### E27-E40

\* ADD. SUFFIX



**E27**  
(GLS-CFL-LED)

E27  
Lampholder only

.E27

**E27**  
WITH  
BALLAST KIT

SON 70W

.S70

HQI 70W

.H70

**E40**  
WITH  
BALLAST KIT

SON 100W

.S10

HQI 100W

.H10

Luminaries supplied with E27 or E40 lampholder and provided as an option complete with ballast kit for SON-HQI lamps.

### HORIZONTAL BULB

AGAINST LIGHT POLLUTION

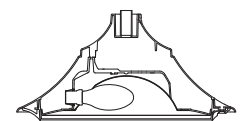

E27 - E40 VERSION

\* ADD THESE SUFFIXES TO THE REFERENCES MENTIONED IN THE CATALOGUE

### PHOTOMETRIC DATA SAMPLE

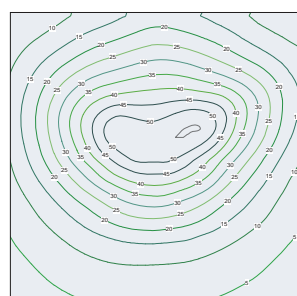
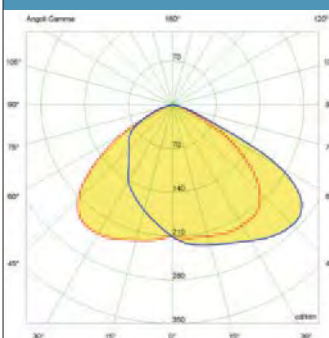

**ECOVIVI 400** clear HQI 70W.

POST height 3,5mt  
10x10mt area: average 20 lux

The photometric data for all the versions are available upon request or on our website.

# ECOVIVI 400 LED

## LARGE SIZE

Modern luminaries made of shockproof resin material, UV-rays stabilized, rust and corrosion-free. Suitable for post top, wall and hanging installation. Supplied with flat diffuser granting no upward light emission. Equipped with TÜV approved, long-life and efficient **GX53 LED modular system** in different wattages. Designed according to the international regulations against light pollution (standard UNI 10819 – Installation area: Zone 1). Insulation class II, Protection rating IP65.

*Diffusore moderno realizzato in resina antiurto, stabilizzato ai raggi UV, inattaccabile da ruggine e corrosione. Idoneo per il montaggio a palo, a sospensione o a parete. Fornito con diffusore piatto per garantire assenza di emissioni di luce verso l'alto. Provvisto di sistema modulare a LED GX53 approvato TÜV di lunga durata ed alta efficienza disponibile in diverse potenze. Progettato in ottemperanza alle norme internazionali contro l'inquinamento luminoso (standard UNI 10819 – Area di installazione: Zona 1). Classe di isolamento II, grado di protezione IP65.*



EV4.000.C6L



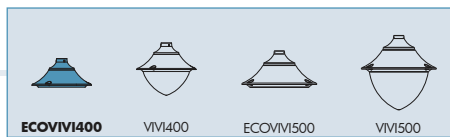

**ECOVIVI 400 LED VERSION - COMPONENTS**

**IP65**



**ROOF** made of shockproof resin material one piece only, UV-rays stabilized, rust and corrosion-free.

**TETTO** in un unico pezzo, realizzato in resina antiurto, stabilizzata ai raggi UV, inattaccabile da ruggine e corrosione.



**DIFFUSER** with flat shape to avoid the skyward dispersion of the luminous flux, according to the international regulations against light pollution and in particular the standard UNI 108119. Made of UV-rays stabilized polycarbonate (PC) and available in clear and opal colour.

**DIFFUSORE** con configurazione piatta per evitare la dispersione verso il cielo del flusso luminoso, in ottemperanza alle norme internazionali sull'inquinamento luminoso ed in particolare la norma UNI 10819. Realizzato in policarbonato (PC) stabilizzato ai raggi UV e disponibile in colore trasparente o opale.



Decorative connection **RING** to be fixed on the luminaries diffuser.



**ANELLO** decorative di connessione da fissare sul diffusore dell'apparecchio.

**ECOVIVI 400 LED**

EV4.000 \*



**Dimensions and weight**

Height: 243 mm  
Diameter: 480 mm  
Weight: 4,7 Kg  
Junction to support: diameter 60 mm  
Area expose to wind pressure: CxS = m<sup>2</sup> 0,1449

**Moulded colours:**

Black White Grey

**Diffuser PC (UV treated):**

Clear Opal

**GX53 LED**



- **COST SAVING:** long-life and efficient LED light sources.
- **BUILT-IN DRIVER:** quick and easy lamp replacement
- **GREAT FLEXIBILITY:** GX53 standard lamp holder.
- **FUTURE-PROOFED LUMINARIES:** performances easy to upgrade to latest technology developments.
- **SUITABLE FOR OUTDOOR USE:** built-in driver fully protected against heat and humidity by silicone paste.

\*ADD. SUFFIX

Luminaries supplied with white resin CEILING provided with TÜV approved, long-life and efficient **6x GX53 LED lamps included**. Each lamp can be quickly and easily replaced individually, making the luminaries maintenance very simple.



GX53 LED	6x 7W <b>42W</b>	<b>4800 Lm</b>	4000 K .C6L	3000 K .C6R
	6x 10W <b>60W</b>	<b>7200 Lm</b>	4000 K .D6L	3000 K .D6R

**LED LAMPS**

More technical details about TÜV approved Fumagalli LED Lamps on page 468.

\* ADD THESE SUFFIXES TO THE REFERENCES MENTIONED IN THE CATALOGUE

**PHOTOMETRIC DATA SAMPLE**

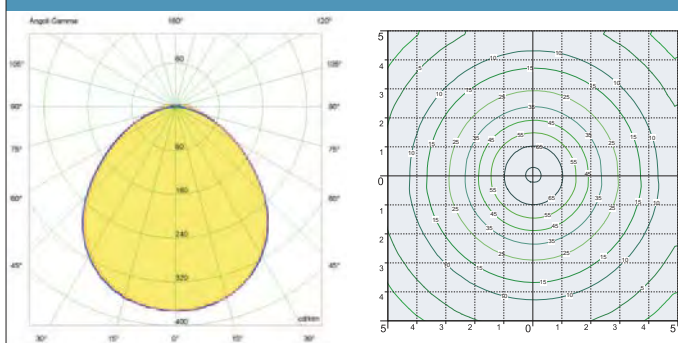

**ECOVIVI 400 LED**



**SAVE -50%**

**6x7W GX53 LED 42W**  
(power consumption)

Area: 10x10mt  
Height: 3,5mt  
**20 lux**

**VIVI 400 E27**



**HQI 70W 84W**  
(power consumption)

Area: 10x10mt  
Height: 3,5mt  
**20 lux**

# ECOVIVI 400

## LARGE SIZE

BULKHEAD  
FLOODLIGHT  
IN-GROUND  
BRICKLIGHT  
BOLLARDS  
GARDEN  
URBAN CLASSIC  
URBAN MODERN  
HIGH-BAY  
POST  
LAMPS



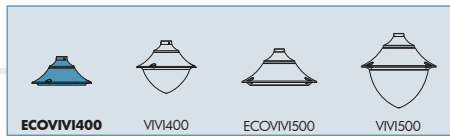

**MIDIPILAR/ECOVIVI400**  
EV4.254

Pcs 1  
Kg 5,5  
mc 0,092

**EKTOR 3500**      **EKTOR 4000**  
**MIDIPILAR/ECOVIVI400 1L**    **MIDIPILAR/ECOVIVI400 1L**

EV4.367.A10      EV4.371.A10

Pcs 1      Pcs 1  
Kg 38,7      Kg 41,7  
mc 0,284      mc 0,314

**ECOVIVI 400**  
EV4.000

Pcs 1  
Kg 3,7  
mc 0,09

**MARIO/ECOVIVI400**  
EV4.129

Pcs 1  
Kg 4,5  
mc 0,07

**EKTOR 2500 MIDIPILAR/ECOVIVI400 1L**  
EV4.361.A10

Pcs 1  
Kg 25,7  
mc 0,235

**EKTOR 3000 MIDIPILAR/ECOVIVI400 1L**  
EV4.364.A10

Pcs 1  
Kg 35,7  
mc 0,262

**NEW LOT/ECOVIVI400**  
EV4.115

Pcs 1  
Kg 4,5  
mc 0,071



**EKTOR/ECOVIVI 400**  
**LARGE SIZE**

BULKHEAD  
 FLOODLIGHT  
 IN-GROUND  
 BRICKLIGHT  
 BOLLARDS  
 GARDEN  
 URBAN CLASSIC  
 URBAN MODERN  
 HIGH-BAY  
 POST  
 LAMPS

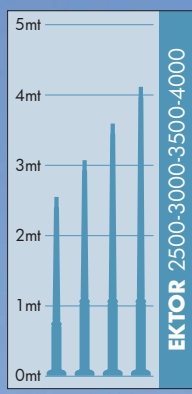

Pag.464

EV4.364.A20.C6L



EV4.371.A10.D6L



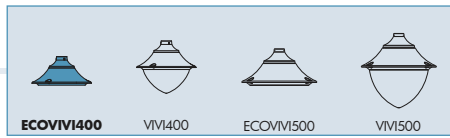

EKTOR 3500 MIDIPILAR/ECOVIVI400 2L	EKTOR 4000 MIDIPILAR/ECOVIVI400 2L
EV4.367.A20	EV4.371.A20
Pcs 1 Kg 44,1 mc 0,358	Pcs 1 Kg 47,1 mc 0,385

EKTOR 3500 MIDIPILAR/ECOVIVI400 3L	EKTOR 4000 MIDIPILAR/ECOVIVI400 3L
EV4.367.A30	EV4.371.A30
Pcs 1 Kg 49,7 mc 0,55	Pcs 1 Kg 52,7 mc 0,576

EKTOR 2500 MIDIPILAR/ECOVIVI400 2L	EKTOR 3000 MIDIPILAR/ECOVIVI400 2L
EV4.361.A20	EV4.364.A20
Pcs 1 Kg 31,1 mc 0,306	Pcs 1 Kg 41,1 mc 0,332

EKTOR 2500 MIDIPILAR/ECOVIVI400 3L	EKTOR 3000 MIDIPILAR/ECOVIVI400 3L
EV4.361.A30	EV4.364.A30
Pcs 1 Kg 36,7 mc 0,497	Pcs 1 Kg 46,7 mc 0,523

# AKILLE/ECOVIVI 400

## LARGE SIZE

BULKHEAD  
FLOODLIGHT  
IN-GROUND  
BRICKLIGHT  
BOLLARDS  
GARDEN  
URBAN CLASSIC  
URBAN MODERN  
HIGH-BAY  
POST  
LAMPS

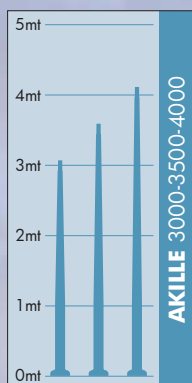

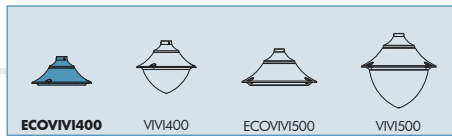

AKILLE 3500 MIDIPIILAR/ECOVIVI400 1L	AKILLE 4000 MIDIPIILAR/ECOVIVI400 1L
EV4.417.A10	EV4.421.A10
Pcs 1 Kg 38,7 mc 0,284	Pcs 1 Kg 41,7 mc 0,314

AKILLE 3500 MIDIPIILAR/ECOVIVI400 2L	AKILLE 4000 MIDIPIILAR/ECOVIVI400 2L
EV4.417.A20	EV4.421.A20
Pcs 1 Kg 44,1 mc 0,358	Pcs 1 Kg 47,1 mc 0,385

AKILLE 3500 MIDIPIILAR/ECOVIVI400 3L	AKILLE 4000 MIDIPIILAR/ECOVIVI400 3L
EV4.417.A30	EV4.421.A30
Pcs 1 Kg 49,7 mc 0,55	Pcs 1 Kg 52,7 mc 0,576

AKILLE 3000 MIDIPIILAR/ECOVIVI400 1L
EV4.414.A10
Pcs 1 Kg 35,7 mc 0,262

AKILLE 3000 MIDIPIILAR/ECOVIVI400 2L
EV4.414.A20
Pcs 1 Kg 41,1 mc 0,332

AKILLE 3000 MIDIPIILAR/ECOVIVI400 3L
EV4.414.A30
Pcs 1 Kg 46,7 mc 0,523

# VIVI 400

## LARGE SIZE

Modern luminaries made of shockproof resin material, UV-rays stabilized, rust and corrosion-free. Suitable for post top, wall and hanging installation. Provided with high temperature resistant ceiling suitable for horizontal bulb fixation and with aluminum reflector to optimize the light distribution. Designed according to the international regulations against light pollution (standard UNI 10819). Insulation class II, Protection rating IP65.

*Diffusore moderno realizzato in resina antiurto, stabilizzato ai raggi UV, inattaccabile da ruggine e corrosione. Idoneo per il montaggio a palo, a sospensione o a parete. Fornito con soffitto ad alta resistenza al calore idoneo per il fissaggio orizzontale della lampadina e provvisto di parabola riflettente in alluminio per direzionare il flusso luminoso. Progettato in ottemperanza alle norme internazionali contro l'inquinamento luminoso (standard UNI 10819). Classe di isolamento II, grado di protezione IP65.*

V50.000



BULKHEAD

FLOODLIGHT

IN-GROUND

BRICKLIGHT

BOLLARDS

GARDEN

URBAN CLASSIC

URBAN MODERN

HIGH-BAY

POST

LAMPS

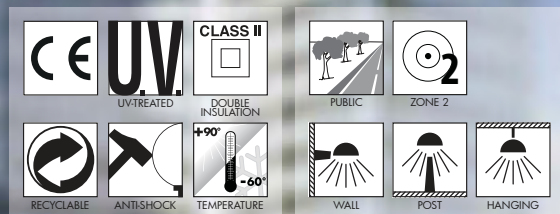

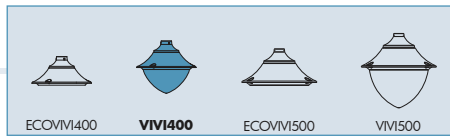

**VIVI 400 E27 - E40 VERSION - COMPONENTS**

**IP65**



**ROOF** made of shockproof resin material, UV-rays stabilized, rust and corrosion-free.

**TETTO** realizzato in resina antiurto, stabilizzata ai raggi UV, inattaccabile da ruggine e corrosione.

High temperature resistant **CEILING** made of white polycarbonate (PC), UV-rays stabilized, suitable for ballast fixation on its upper side and provided with E27 or E40 lampholder on its lower side. Bulb in horizontal position.

**SOFFITTO** realizzato in policarbonato bianco (PC) ad alta resistenza al calore, stabilizzato ai raggi UV, nella cui parte superiore vengono fissati i reattori. Fornito completo di portalampada E27 o E40 atto a sostenere la lampadina in posizione orizzontale.

Parabolic **REFLECTOR** made of anodized aluminium, designed to optimize the light distribution and to limit the skyward dispersion of the luminous flux.

**PARABOLA** riflettente realizzata in alluminio anodizzato, progettata per ottimizzare la distribuzione del flusso luminoso e limitarne la dispersione verso il cielo.

**DIFFUSER** made of UV-rays stabilized polymethylmethacrylate (PMMA), one piece only, available in clear or opal colour.

**DIFFUSORE** realizzato in polimetilmetacrilato (PMMA) stabilizzato ai raggi UV, un pezzo unico, disponibile in colore trasparente o opale.

Decorative connection **RING** to be fixed on the luminaries diffuser.

**ANELLO** decorativo di connessione da fissare sul diffusore dell'apparecchio.

**VIVI 400**

V50.000 \*



**Dimensions and weight**

Height: 420 mm  
Diameter: 480 mm  
Weight: 3,7 Kg  
Junction to support: Ø 60 mm  
Area expose to wind pressure: CxS = m<sup>2</sup> 0,1449

**Moulded colours:**

Black White Grey

**Diffuser PMMA:**

Clear Opal

**E27-E40**

\* ADD. SUFFIX

	<b>E27</b> (GLS-CFL-LED)	E27 Lampholder only	.E27
	<b>E27</b> WITH BALLAST KIT	SON 70W HQI 70W	.S70 .H70
Luminaries supplied with E27 or E40 lampholder and provided as an option complete with ballast kit for SON-HQI lamps.	<b>E40</b> WITH BALLAST KIT	SON 100W	.S10
		HQI 100W	.H10

**HORIZONTAL BULB**

AGAINST LIGHT POLLUTION

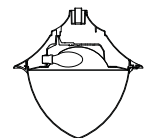

E27 - E40 VERSION

\* ADD THESE SUFFIXES TO THE REFERENCES MENTIONED IN THE CATALOGUE

**PHOTOMETRIC DATA SAMPLE**

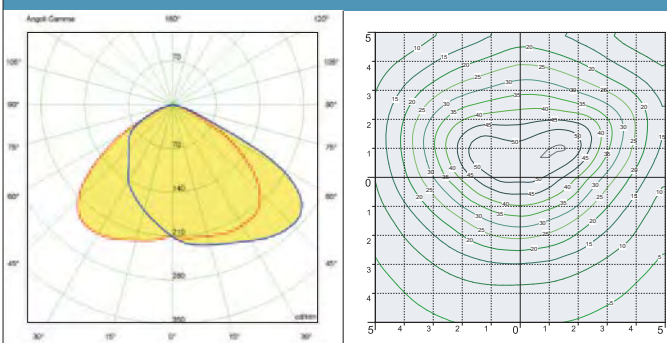

**VIVI 400** clear HQI 70W.

POST height 3,5mt  
10x10mt area: average 20 lux

The photometric data for all the versions are available upon request or on our website.

# VIVI 400 LED

## LARGE SIZE

Modern luminaries made of shockproof resin material, UV-rays stabilized, rust and corrosion-free. Suitable for post top, wall and hanging installation. Equipped with TÜV approved, long-life and efficient **GX53 LED modular system** in different wattages. Designed according to the international regulations against light pollution (standard UNI 10819). Insulation class II, Protection rating IP65.

*Diffusore moderno realizzato in resina antiurto, stabilizzato ai raggi UV, inattaccabile da ruggine e corrosione. Idoneo per il montaggio a palo, a sospensione o a parete. Provvisto di **sistema modulare a LED GX53** approvato TÜV di lunga durata ed alta efficienza disponibile in diverse potenze. Progettato in ottemperanza alle norme internazionali contro l'inquinamento luminoso (standard UNI 10819). Classe di isolamento II, grado di protezione IP65.*



V50.000.D6L

BULKHEAD  
FLOODLIGHT  
IN-GROUND  
BRICKLIGHT  
BOLLARDS  
GARDEN  
URBAN CLASSIC  
URBAN MODERN  
HIGH-BAY  
POST  
LAMPS





**VIVI 400 LED VERSION - COMPONENTS**

**IP65**



**ROOF** made of shockproof resin material one piece only, UV-rays stabilized, rust and corrosion-free.

**TETTO** in un unico pezzo, realizzato in resina antiurto, stabilizzata ai raggi UV, inattaccabile da ruggine e corrosione.



**DIFFUSER** made of UV-rays stabilized polymethylmethacrylate (PMMA), one piece only, available in clear or opal colour.

**DIFFUSORE** realizzato in polimetilmetacrilato (PMMA) stabilizzato ai raggi UV, disponibile in colore trasparente o opale.



Decorative connection **RING** to be fixed on the luminaries diffuser.

**ANELLO** decorativo di connessione da fissare sul diffusore dell'apparecchio.

**VIVI 400 LED**

V50.000 \*



**Dimensions and weight**

Height: 420 mm  
Diameter: 480 mm  
Weight: 4,9 Kg  
Junction to support: Ø 60 mm  
Area expose to wind pressure:  
CxS = m<sup>2</sup> 0,1449

**Moulded colours:**

Black  White  Grey

**Diffuser PMMA:**

Clear  Opal

**GX53 LED**



- **COST SAVING:** long-life and efficient LED light sources.
- **BUILT-IN DRIVER:** quick and easy lamp replacement
- **GREAT FLEXIBILITY:** GX53 standard lamp holder.
- **FUTURE-PROOFED LUMINARIES:** performances easy to upgrade to latest technology developments.
- **SUITABLE FOR OUTDOOR USE:** built-in driver fully protected against heat and humidity by silicone paste.

\*ADD. SUFFIX

Luminaries supplied with white resin CEILING provided with TÜV approved, long-life and efficient 6x GX53 LED lamps included. Each lamp can be quickly and easily replaced individually, making the luminaries maintenance very simple.



6x 7W <b>42W</b>	<b>4800 Lm</b>	4000 K	.C6L
		3000 K	.C6R
6x 10W <b>60W</b>	<b>7200 Lm</b>	4000 K	.D6L
		3000 K	.D6R

**LED LAMPS**

More technical details about TÜV approved Fumagalli LED Lamps on page 468.



\* ADD THESE SUFFIXES TO THE REFERENCES MENTIONED IN THE CATALOGUE

**PHOTOMETRIC DATA SAMPLE - VIVI 400 LED**

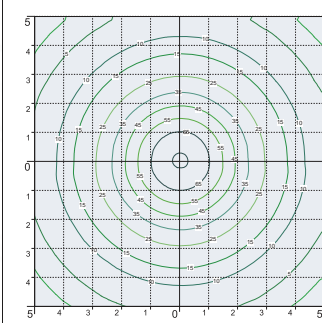
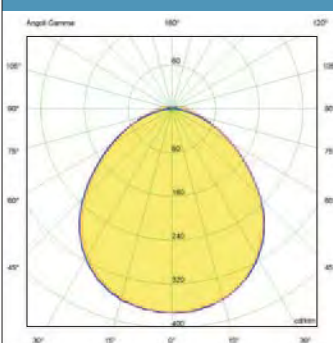

**SAVE -50%**

6x7W GX53 LED  
**42W**  
(power consumption)

Area: 10x10mt  
Height: 3,5mt  
**20 lux**



**VIVI 400 E27**

HQI 70W  
**84W**  
(power consumption)

Area: 10x10mt  
Height: 3,5mt  
**20 lux**



# VIVI 400

## LARGE SIZE

BULKHEAD  
FLOODLIGHT  
IN-GROUND  
BRICKLIGHT  
BOLLARDS  
GARDEN  
URBAN CLASSIC  
URBAN MODERN  
HIGH-BAY  
POST  
LAMPS





**MIDIPIALAR/VIVI400**  
V50.254

Pcs 1  
Kg 5,5  
mc 0,092

**EKTOR 3500**      **EKTOR 4000**  
**MIDIPIALAR/VIVI400 1L**      **MIDIPIALAR/VIVI400 1L**  
V50.367.A10      V50.371.A10

Pcs 1      Pcs 1  
Kg 38,7      Kg 41,7  
mc 0,284      mc 0,314

**VIVI 400**  
V50.000

Pcs 1  
Kg 3,7  
mc 0,09

**MARIO/VIVI400**  
V50.129

Pcs 1  
Kg 4,5  
mc 0,07

**EKTOR 2500 MIDIPIALAR/VIVI400 1L**  
V50.361.A10

Pcs 1  
Kg 25,7  
mc 0,235

**EKTOR 3000 MIDIPIALAR/VIVI400 1L**  
V50.364.A10

Pcs 1  
Kg 35,7  
mc 0,262

**NEW LOT/VIVI400**  
V50.115

Pcs 1  
Kg 4,5  
mc 0,071

EKTOR/VIVI 400  
LARGE SIZE

BULKHEAD  
FLOODLIGHT  
IN-GROUND  
BRICKLIGHT  
BOLLARDS  
GARDEN  
URBAN CLASSIC  
URBAN MODERN  
HIGH-BAY  
POST  
LAMPS

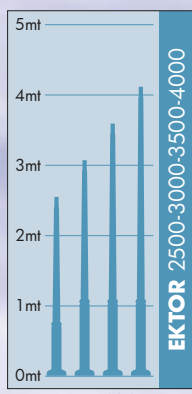
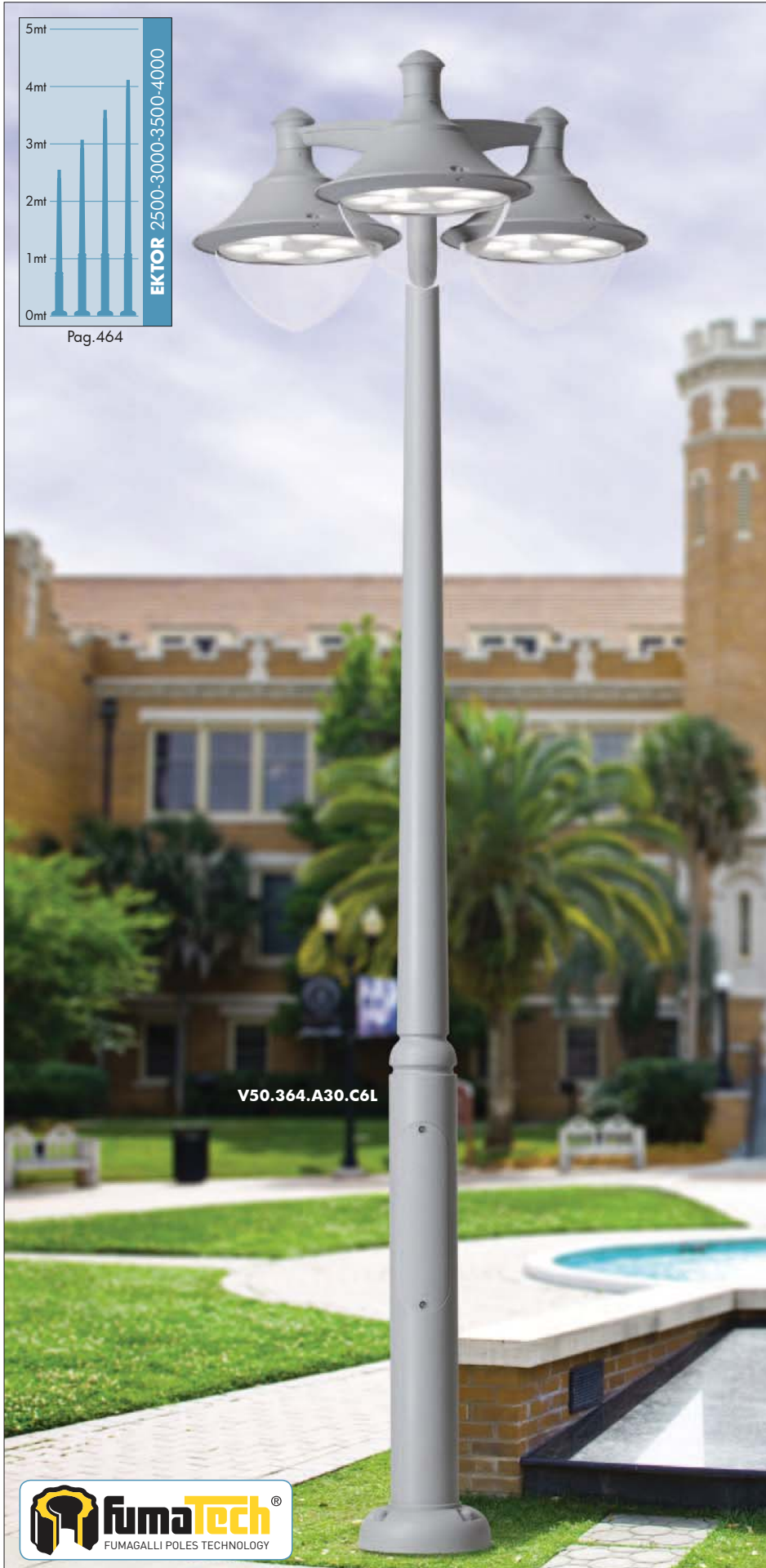



EKTOR 3500 MIDIPILAR/VIVI400 2L	EKTOR 4000 MIDIPILAR/VIVI400 2L
V50.367.A20	V50.371.A20
Pcs 1 Kg 44,1 mc 0,358	Pcs 1 Kg 47,1 mc 0,385

EKTOR 3500 MIDIPILAR/VIVI400 3L	EKTOR 4000 MIDIPILAR/VIVI400 3L
V50.367.A30	V50.371.A30
Pcs 1 Kg 49,7 mc 0,55	Pcs 1 Kg 52,7 mc 0,576

EKTOR 2500 MIDIPILAR/VIVI400 2L	EKTOR 3000 MIDIPILAR/VIVI400 2L
V50.361.A20	V50.364.A20
Pcs 1 Kg 31,1 mc 0,306	Pcs 1 Kg 41,1 mc 0,332

EKTOR 2500 MIDIPILAR/VIVI400 3L	EKTOR 3000 MIDIPILAR/VIVI400 3L
V50.361.A30	V50.364.A30
Pcs 1 Kg 36,7 mc 0,497	Pcs 1 Kg 46,7 mc 0,523

**AKILLE/VIVI 400**  
**LARGE SIZE**

BULKHEAD  
 FLOODLIGHT  
 IN-GROUND  
 BRICKLIGHT  
 BOLLARDS  
 GARDEN  
 URBAN CLASSIC  
 URBAN MODERN  
 HIGH-BAY  
 POST  
 LAMPS



**V50.414.A10**

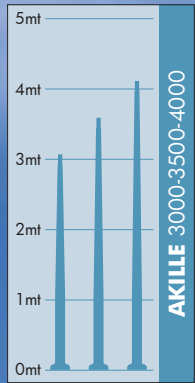

Pag.464



**V50.421.A30.C6L**



**V50.421.A20.C6L**

**MADE IN ITALY**



AKILLE 3500 MIDIPILAR/VIVI400 1L	AKILLE 4000 MIDIPILAR/VIVI400 1L
V50.417.A10	V50.421.A10
Pcs 1 Kg 38,7 mc 0,284	Pcs 1 Kg 41,7 mc 0,314

AKILLE 3500 MIDIPILAR/VIVI400 2L	AKILLE 4000 MIDIPILAR/VIVI400 2L
V50.417.A20	V50.421.A20
Pcs 1 Kg 44,1 mc 0,358	Pcs 1 Kg 47,1 mc 0,385

AKILLE 3500 MIDIPILAR/VIVI400 3L	AKILLE 4000 MIDIPILAR/VIVI400 3L
V50.417.A30	V50.421.A30
Pcs 1 Kg 49,7 mc 0,55	Pcs 1 Kg 52,7 mc 0,576

AKILLE 3000 MIDIPILAR/VIVI400 1L
V50.414.A10
Pcs 1 Kg 35,7 mc 0,262
Ø 265

AKILLE 3000 MIDIPILAR/VIVI400 2L
V50.414.A20
Pcs 1 Kg 41,1 mc 0,332
Ø 265

AKILLE 3000 MIDIPILAR/VIVI400 3L
V50.414.A30
Pcs 1 Kg 46,7 mc 0,523
Ø 265

# REMO 400

## LARGE SIZE

Modern luminaries made of shockproof resin material, UV-rays stabilized, rust and corrosion-free. Suitable for post top or wall installation. Provided with aluminum reflector to optimize the light distribution. Base equipped with E27 lampholder prepared for ballast and louvre fixation. Insulation class II, Protection rating IP65.

*Diffusore moderno realizzato in resina antiurto, stabilizzato ai raggi UV, inattaccabile da ruggine e corrosione. Idoneo per il montaggio a palo o a parete. Provvisto di parabola riflettente in alluminio per direzionare il flusso luminoso. Base con portalampada E27 predisposta per il fissaggio dei reattori e del frangiluce. Idoneo per il montaggio a palo e a parete. Classe di isolamento II, grado di protezione IP65.*

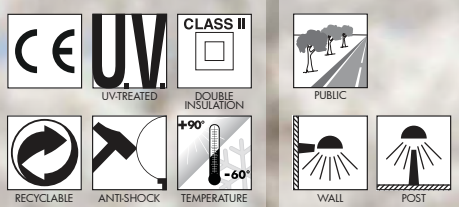

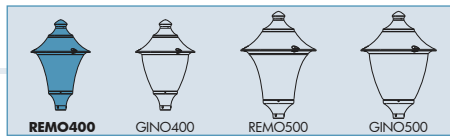

**REMO 400 - COMPONENTS**



IP65



**ROOF** complete with decorative pinnacle made in shockproof resin material, UV-rays stabilized, rust and corrosion-free.

**TETTO** completo di pinnacolo decorativo, realizzato in resina antiurto, stabilizzato ai raggi UV, inattaccabile da ruggine e corrosione.

Parabolic **REFLECTOR** made of anodized aluminium and fixed under the luminaries roof, designed to optimize the light efficiency performance and to allow a uniform light distribution.

**PARABOLA** riflettente realizzata in alluminio anodizzato, fissata sotto il tetto del diffusore, progettata per ottimizzare il rendimento luminoso e permettere una uniforme distribuzione della luce.

**DIFFUSER** made of UV-rays stabilized polymethylmethacrylate (PMMA), one piece only, available in clear or opal colour.

**DIFFUSORE** realizzato in polimetilmetacrilato (PMMA) stabilizzato ai raggi UV, un pezzo unico, disponibile in colore trasparente o opale.

Chrome aluminium **LOUVRE** with a laminar symmetrical optic system to direct the lighting output and to get a lower dazzle (optional).

**FRANGILUCE** in alluminio cromato con sistema ottico lamellare a ripartizione simmetrica per orientare il fascio di luce e ridurre l'abbagliamento (opzionale).

Resin **BASE** consisting of a support (Ø 60mm) and of a cover suitable for ballast kit fixation on its lower side and provided with E27 or E40 lampholder on its upper side. A rubber gasket assures the protection of the electrical accessories seat against external agents.

**BASE** in resina composta da un supporto e da un coperchio nella cui parte inferiore possono essere fissati i reattori e nella cui parte superiore si trova l'alloggiamento per il portalampada E27 o E40 (incluso). Una guarnizione in gomma garantisce la protezione dell'alloggiamento degli accessori elettrici dagli agenti esterni.

**REMO 400**

R50.000 \*

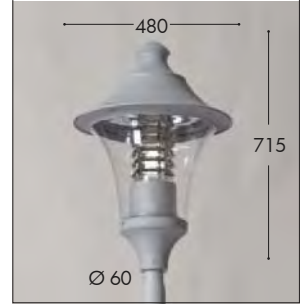

**Dimensions and weight**

Height: 715 mm  
Diameter: 480 mm  
Weight: 5,9 Kg  
Junction to support: diameter 60 mm  
Area expose to wind pressure:  
CxS = m<sup>2</sup> 0,157

**Moulded colours:**

Black White Grey

**Diffuser PMMA:**

Clear Opal

**CHROME ALUMINIUM LOUVRE**

H.FC6 open  
Upward position



**E27-E40**

\* ADD. SUFFIX

	<b>E27</b> (GLS-CFL-LED)	E27 Lampholder only	.E27
	<b>E27</b> WITH BALLAST KIT	SON 70W HQI 70W	.S70 .H70
Luminaries supplied with E27 or E40 lampholder and provided as an option complete with ballast kit for SON-HQI lamps.	<b>E40</b> WITH BALLAST KIT	SON 100W	.S10
		HQI 100W	.H10

\* ADD THESE SUFFIXES TO THE REFERENCES MENTIONED IN THE CATALOGUE

**PHOTOMETRIC DATA SAMPLE**

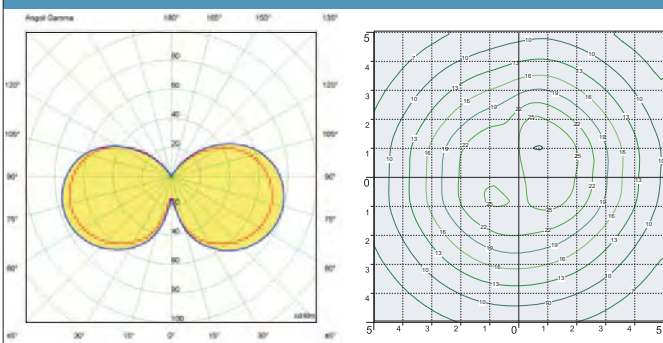

**REMO 400** clear HQI 100W.

POST height 3,5mt  
10x10mt area: average 15 lux

The photometric data for all the versions are available upon request or on our website.



# REMO 400 LED

## LARGE SIZE

Modern luminaries made of shockproof resin material, UV-rays stabilized, rust and corrosion-free. Suitable for post top or wall installation. Equipped with TÜV approved, long-life and efficient **GX53 LED modular system** in different wattages. Insulation class II, Protection rating IP65.

*Diffusore moderno realizzato in resina antiurto, stabilizzato ai raggi UV, inattaccabile da ruggine e corrosione. Idoneo per il montaggio a palo o a parete. Provvisto di **sistema modulare a LED GX53** approvato TÜV di lunga durata ed alta efficienza disponibile in diverse potenze. Classe di isolamento II, grado di protezione IP65.*



R50.000.D6L

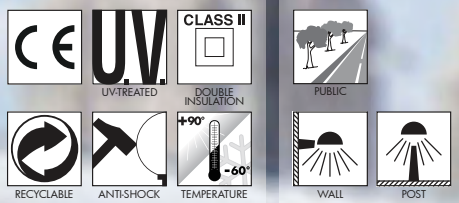

BULKHEAD

FLOODLIGHT

IN-GROUND

BRICKLIGHT

BOLLARDS

GARDEN

URBAN CLASSIC

URBAN MODERN

HIGH-BAY

POST

LAMPS

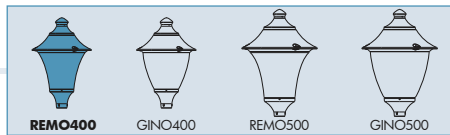

**REMO 400 - COMPONENTS**

**IP65**



**ROOF** complete with decorative pinnacle made in shockproof resin material, UV-rays stabilized, rust and corrosion-free.

**TETTO** completo di pinnacolo decorativo, realizzato in resina antiurto, stabilizzato ai raggi UV, inattaccabile da ruggine e corrosione.

**DIFFUSER** made of UV-rays stabilized polymethylmethacrylate (PMMA), one piece only, available in clear or opal colour.

**DIFFUSORE** realizzato in polimetilmetacrilato (PMMA) stabilizzato ai raggi UV, un pezzo unico, disponibile in colore trasparente o opale.

Decorative connection **RING** to be fixed on the luminaries diffuser.

**ANELLO** decorative di connessione da fissare sul diffusore dell'apparecchio.

**BASE** made in shockproof resin material consisting of a support for post top installation (Ø 60mm) and of a white resin **CONE REFLECTOR**, to direct downwards the lighting output. A silicone rubber gasket assure the protection against external agents.

**BASE** dell'apparecchio realizzata in resina antiurto composta da un supporto per permettere il fissaggio dell'apparecchio a palo (Ø 60mm) e da un **CONO** riflettente in resina bianca per indirizzare verso il basso il flusso luminoso. Una guarnizione in gomma siliconica garantisce la protezione dagli agenti esterni.

**REMO 400 LED**

R50.000 \*



**Dimensions and weight**

Height: 715 mm  
Diameter: 480 mm  
Weight: 7,1 Kg  
Junction to support: diameter 60 mm  
Area expose to wind pressure:  
CxS = m<sup>2</sup> 0,157

**Moulded colours:**

Black White Grey

**Diffuser PMMA:**

Clear Opal

**GX53 LED**



- **COST SAVING:** long-life and efficient LED light sources.
- **BUILT-IN DRIVER:** quick and easy lamp replacement
- **GREAT FLEXIBILITY:** GX53 standard lamp holder.
- **FUTURE-PROOFED LUMINARIES:** performances easy to upgrade to latest technology developments.
- **SUITABLE FOR OUTDOOR USE:** built-in driver fully protected against heat and humidity by silicone paste.

\*ADD. SUFFIX

Luminaries supplied with white resin CEILING provided with TÜV approved, long-life and efficient 6x GX53 LED lamps included. Each lamp can be quickly and easily replaced individually, making the luminaries maintenance very simple.



6x 7W <b>42W</b>	<b>4800 Lm</b>	4000 K	.C6L
		3000 K	.C6R
6x 10W <b>60W</b>	<b>7200 Lm</b>	4000 K	.D6L
		3000 K	.D6R

**LED LAMPS**



More technical details about TÜV approved Fumagalli LED Lamps on page 468.

\* ADD THESE SUFFIXES TO THE REFERENCES MENTIONED IN THE CATALOGUE

**PHOTOMETRIC DATA SAMPLE - REMO 400 LED**

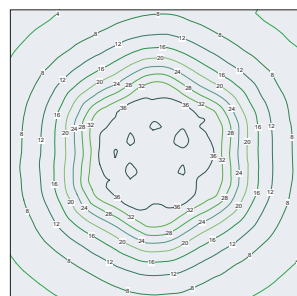
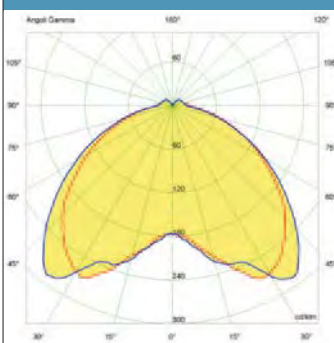

6x7W GX53 LED  
**42W**  
(power consumption)

Area: 10x10mt  
Height: 3,5mt  
**17 lux**

=



HQI 100W  
**115W**  
(power consumption)

Area: 10x10mt  
Height: 3,5mt  
**15 lux**

**EKTOR/REMO 400**  
**LARGE SIZE**

BULKHEAD  
 FLOODLIGHT  
 IN-GROUND  
 BRICKLIGHT  
 BOLLARDS  
 GARDEN  
 URBAN CLASSIC  
 URBAN MODERN  
 HIGH-BAY  
 POST  
 LAMPS

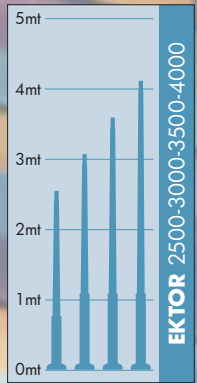

Pag. 464

**R50.364.C6L**



**R50.115**



**R50.254**



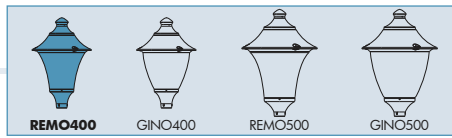

**MIDIPILAR/REMO400**  
R50.254

Pcs 1  
Kg 7,5  
mc 0,09

**NEW LOT/REMO400**  
R50.115

Pcs 1  
Kg 6,5  
mc 0,07

**EKTOR 3500/REMO400**  
R50.367.000

Pcs 1  
Kg 38,9  
mc 0,268

**REMO400**  
R50.000

Pcs 1  
Kg 5,9  
mc 0,06

**EKTOR 2500/REMO400**  
R50.361.000

Pcs 1  
Kg 25,9  
mc 0,21

**EKTOR 3000/REMO400**  
R50.364.000

Pcs 1  
Kg 35,9  
mc 0,241

**EKTOR 3500/REMO400**  
R50.367.000

Pcs 1  
Kg 38,9  
mc 0,268

**EKTOR 4000/REMO400**  
R50.371.000

Pcs 1  
Kg 41,9  
mc 0,294

# EKTOR/REMO 400 LARGE SIZE

- BULKHEAD
- FLOODLIGHT
- IN-GROUND
- BRICKLIGHT
- BOLLARDS
- GARDEN
- URBAN CLASSIC
- URBAN MODERN
- HIGH-BAY
- POST
- LAMPS

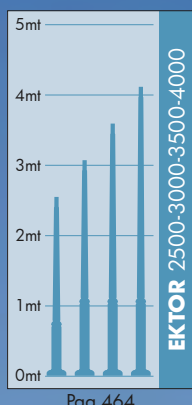

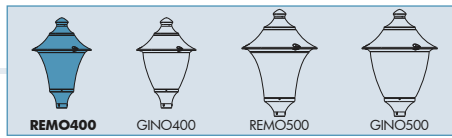

**EKTOR 3500 MIDIPILAR/REMO400 2L**    **EKTOR 4000 MIDIPILAR/REMO400 2L**

**R50.367.A20**                      **R50.371.A20**

Pcs 1                      Pcs 1  
Kg 48,5                      Kg 51,5  
mc 0,37                      mc 0,397

**EKTOR 3500 MIDIPILAR/REMO400 3L**    **EKTOR 4000 MIDIPILAR/REMO400 3L**

**R50.367.A30**                      **R50.371.A30**

Pcs 1                      Pcs 1  
Kg 56,3                      Kg 59,3  
mc 0,568                      mc 0,594

**EKTOR 2500 MIDIPILAR/REMO400 2L**    **EKTOR 3000 MIDIPILAR/REMO400 2L**

**R50.361.A20**                      **R50.364.A20**

Pcs 1                      Pcs 1  
Kg 35,5                      Kg 45,5  
mc 0,318                      mc 0,344

**EKTOR 2500 MIDIPILAR/REMO400 3L**    **EKTOR 3000 MIDIPILAR/REMO400 3L**

**R50.361.A30**                      **R50.364.A30**

Pcs 1                      Pcs 1  
Kg 43,3                      Kg 53,3  
mc 0,515                      mc 0,541

# AKILLE/REMO 400 LARGE SIZE

BULKHEAD

FLOODLIGHT

IN-GROUND

BRICKLIGHT

BOLLARDS

GARDEN

URBAN CLASSIC

URBAN MODERN

HIGH-BAY

POST

LAMPS



MADE IN  
ITALY

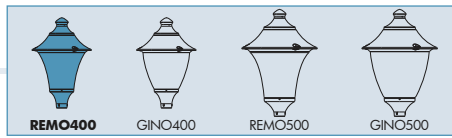

AKILLE 3500/ REMO400	AKILLE 4000/ REMO400
R50.417.000	R50.421.000
Pcs 1 Kg 38,9 mc 0,268	Pcs 1 Kg 41,8 mc 0,294

AKILLE 3500 MIDIPILAR/ REMO400 2L	AKILLE 4000 MIDIPILAR/ REMO400 2L
R50.417.A20	R50.421.A20
Pcs 1 Kg 48,5 mc 0,37	Pcs 1 Kg 51,5 mc 0,397

AKILLE 3500 MIDIPILAR/ REMO400 3L	AKILLE 4000 MIDIPILAR/ REMO400 3L
R50.417.A30	R50.421.A30
Pcs 1 Kg 56,3 mc 0,568	Pcs 1 Kg 59,3 mc 0,594

AKILLE 3000/REMO400
R50.414.000
Pcs 1 Kg 35,9 mc 0,241

AKILLE 3000 MIDIPILAR/REMO400 2L
R50.414.A20
Pcs 1 Kg 45,5 mc 0,344

AKILLE 3000 MIDIPILAR/REMO400 3L
R50.414.A30
Pcs 1 Kg 53,3 mc 0,541

BULKHEAD

FLOODLIGHT

IN-GROUND

BRICKLIGHT

BOLLARDS

GARDEN

URBAN CLASSIC

URBAN MODERN

HIGH-BAY

POST

LAMPS



# GINO 400

## LARGE SIZE

Modern luminaries made of shockproof resin material, UV-rays stabilized, rust and corrosion-free. Moulded colours in paste, no maintenance or painting required. Provided with aluminium reflector to optimize the light distribution and equipped with base prepared for ballast and louvre fixation. Modular construction suitable for post top and wall installation. Insulation class II, Protection rating IP65.

*Diffusore moderno realizzato in resina antiurto, stabilizzato ai raggi UV, inattaccabile da ruggine e corrosione. Colore stampato in pasta, non necessita di verniciatura. Provvisto di parabola riflettente in alluminio e di base predisposta per il fissaggio dei reattori e del frangiluce. Idoneo per il montaggio a palo e a parete. Classe di isolamento II, grado di protezione IP65.*



BULKHEAD

FLOODLIGHT

IN-GROUND

BRICKLIGHT

BOLLARDS

GARDEN

URBAN CLASSIC

URBAN MODERN

HIGH-BAY

POST

LAMPS



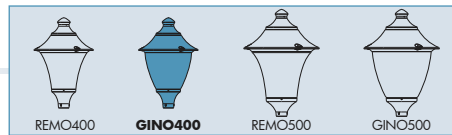

**GINO 400 E27 - E40 VERSION - COMPONENTS**

**IP65**



**ROOF** complete with decorative pinnacle made of shockproof resin material, UV-rays stabilized, rust and corrosion-free.

**TETTO** completo di pinnacolo decorativo, realizzato in resina antiurto, stabilizzato ai raggi UV, inattaccabile da ruggine e corrosione.

Parabolic **REFLECTOR** made of anodized aluminium and fixed under the luminaries roof, designed to optimize the light efficiency performance and to allow a uniform light distribution.

**PARABOLA** riflettente realizzata in alluminio anodizzato fissata sotto il tetto del diffusore, progettata per ottimizzare il rendimento luminoso e permettere una uniforme distribuzione della luce.

**DIFFUSER** made of UV-rays stabilized polymethylmethacrylate (PMMA), one piece only, available in clear or opal colour.

**DIFFUSORE** realizzato in polimetilmetacrilato (PMMA) stabilizzato ai raggi UV, un pezzo unico, disponibile in colore trasparente o opale.



Chrome aluminium **LOUVRE** with a laminar symmetrical optic system to direct the lighting output and to get a lower dazzle (optional).

**FRANGILUCE** in alluminio cromato con sistema ottico lamellare a ripartizione simmetrica per orientare il fascio di luce e ridurre l'abbagliamento (opzionale).

Resin **BASE** consisting of a support (Ø 60mm) and of a cover suitable for ballast kit fixation on its lower side and provided with E27 or E40 lampholder on its upper side. A rubber gasket assures the protection of the electrical accessories seat against external agents.

**BASE** in resina composta da un supporto e da un coperchio nella cui parte inferiore possono essere fissati i reattori e nella cui parte superiore si trova l'alloggiamento per il portalampada E27 o E40 (incluso). Una guarnizione in gomma garantisce la protezione dell'alloggiamento degli accessori elettrici dagli agenti esterni.

**GINO 400**

F50.000 \*



**Dimensions and weight**

Height: 715 mm  
Diameter: 480 mm  
Weight: 5,7 Kg  
Junction to support: diameter 60 mm  
Area expose to wind pressure:  
CxS = m<sup>2</sup> 0,157

**Moulded colours:**

Black  White  Grey

**Diffuser PMMA:**

Clear  Opal

**CHROME ALUMINIUM LOUVRE**

H.FC6 open  
Upward position



**E27-E40**



Luminaries supplied with E27 or E40 lampholder and provided as an option complete with ballast kit for SON-HQI lamps.

<b>E27</b> (GLS-CFL-LED)	E27 Lampholder only	.E27
	SON 70W	.S70
<b>E27</b> WITH BALLAST KIT	HQI 70W	.H70
	SON 100W	.S10
<b>E40</b> WITH BALLAST KIT	HQI 100W	.H10

\* ADD THESE SUFFIXES TO THE REFERENCES MENTIONED IN THE CATALOGUE

**PHOTOMETRIC DATA SAMPLE**

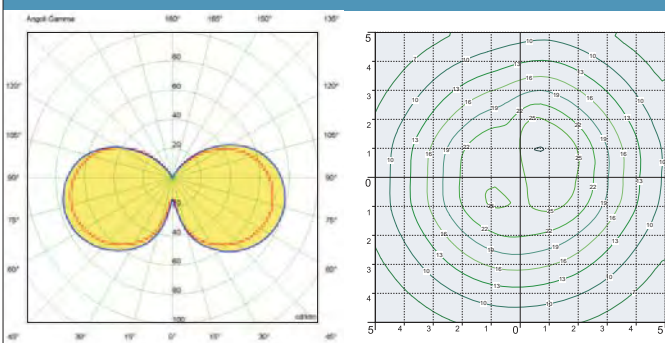

**GINO 400** clear HQI 100W.

POST height 3,5mt  
10x10mt area: average 15 lux

The photometric data for all the versions are available upon request or on our website.

# GINO 400 LED

## LARGE SIZE

Modern luminaries made of shockproof resin material, UV-rays stabilized, rust and corrosion-free. Suitable for post top or wall installation. Equipped with TÜV approved, long-life and efficient **GX53 LED modular system** in different wattages. Insulation class II, Protection rating IP65.

*Diffusore moderno realizzato in resina antiurto, stabilizzato ai raggi UV, inattaccabile da ruggine e corrosione. Idoneo per il montaggio a palo o a parete. Provvisto di **sistema modulare a LED GX53** approvato TÜV di lunga durata ed alta efficienza disponibile in diverse potenze. Classe di isolamento II, grado di protezione IP65.*



F50.000.D6L

BULKHEAD

FLOODLIGHT

IN-GROUND

BRICKLIGHT

BOLLARDS

GARDEN

URBAN CLASSIC

URBAN MODERN

HIGH-BAY

POST

LAMPS

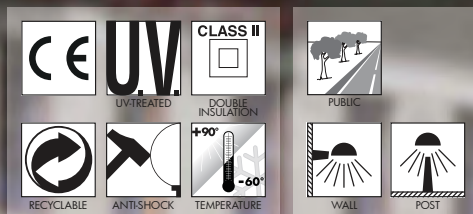

MADE IN ITALY

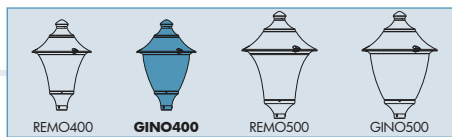

### GINO 400 LED VERSION - COMPONENTS

IP65



**ROOF** complete with decorative pinnacle made of shockproof resin material, UV-rays stabilized, rust and corrosion-free.

**TETTO** completo di pinnacolo decorativo, realizzato in resina antiurto, stabilizzata ai raggi UV, inattaccabile da ruggine e corrosione.

**DIFFUSER** made of UV-rays stabilized polymethylmethacrylate (PMMA), one piece only, available in clear or opal colour.

**DIFFUSORE** realizzato in polimetilmetacrilato (PMMA) stabilizzato ai raggi UV, disponibile in colore trasparente o opale.

Decorative connection **RING** to be fixed on the luminaries diffuser.

**ANELLO** decorative di connessione da fissare sul diffusore dell'apparecchio.

**BASE** made in shockproof resin material consisting of a support for post top installation (Ø 60mm) and of a white resin **CONE REFLECTOR**, to direct downwards the lighting output. A silicone rubber gasket assure the protection against external agents.

**BASE** dell'apparecchio realizzata in resina antiurto composta da un supporto per permettere il fissaggio dell'apparecchio a palo (Ø 60mm) e da un **CONO** riflettente in resina bianca per indirizzare verso il basso il flusso luminoso. Una guarnizione in gomma silconica garantisce la protezione dagli agenti esterni.

### GINO 400 LED

F50.000 \*



#### Dimensions and weight

Height: 715 mm  
Diameter: 480 mm  
Weight: 6,9 Kg  
Junction to support: diameter 60 mm  
Area expose to wind pressure:  
CxS = m<sup>2</sup> 0,157

#### Moulded colours:

Black White Grey

#### Diffuser PMMA:

Clear Opal

### GX53 LED



- **COST SAVING:** long-life and efficient LED light sources.
- **BUILT-IN DRIVER:** quick and easy lamp replacement
- **GREAT FLEXIBILITY:** GX53 standard lamp holder.
- **FUTURE-PROOFED LUMINARIES:** performances easy to upgrade to latest technology developments.
- **SUITABLE FOR OUTDOOR USE:** built-in driver fully protected against heat and humidity by silicone paste.

\*ADD. SUFFIX

Luminaries supplied with white resin CEILING provided with TÜV approved, long-life and efficient 6x GX53 LED lamps included. Each lamp can be quickly and easily replaced individually, making the luminaries maintenance very simple.



6x 7W <b>42W</b>	<b>4800 Lm</b>	4000 K	.C6L
		3000 K	.C6R
6x 10W <b>60W</b>	<b>7200 Lm</b>	4000 K	.D6L
		3000 K	.D6R

### LED LAMPS



More technical details about TÜV approved Fumagalli LED Lamps on page 468.

\* ADD THESE SUFFIXES TO THE REFERENCES MENTIONED IN THE CATALOGUE

### PHOTOMETRIC DATA SAMPLE - GINO 400 LED

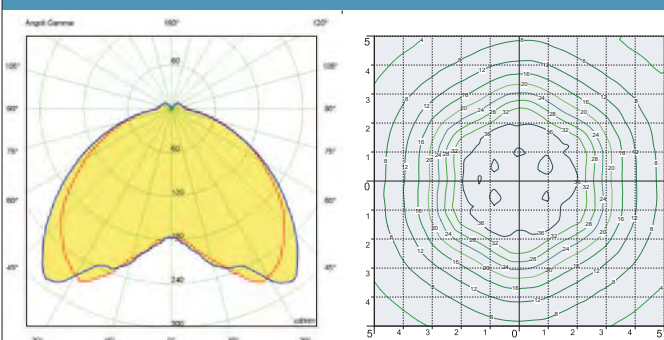

### GINO 400 E40



SAVE  
**-63%**

6x7W GX53 LED  
**42W**  
(power consumption)

Area: 10x10mt  
Height: 3,5mt  
**17 lux**



HQI 100W  
**115W**  
(power consumption)

Area: 10x10mt  
Height: 3,5mt  
**15 lux**

**EKTOR/GINO 400**  
**LARGE SIZE**

BULKHEAD  
 FLOODLIGHT  
 IN-GROUND  
 BRICKLIGHT  
 BOLLARDS  
 GARDEN  
 URBAN CLASSIC  
 URBAN MODERN  
 HIGH-BAY  
 POST  
 LAMPS

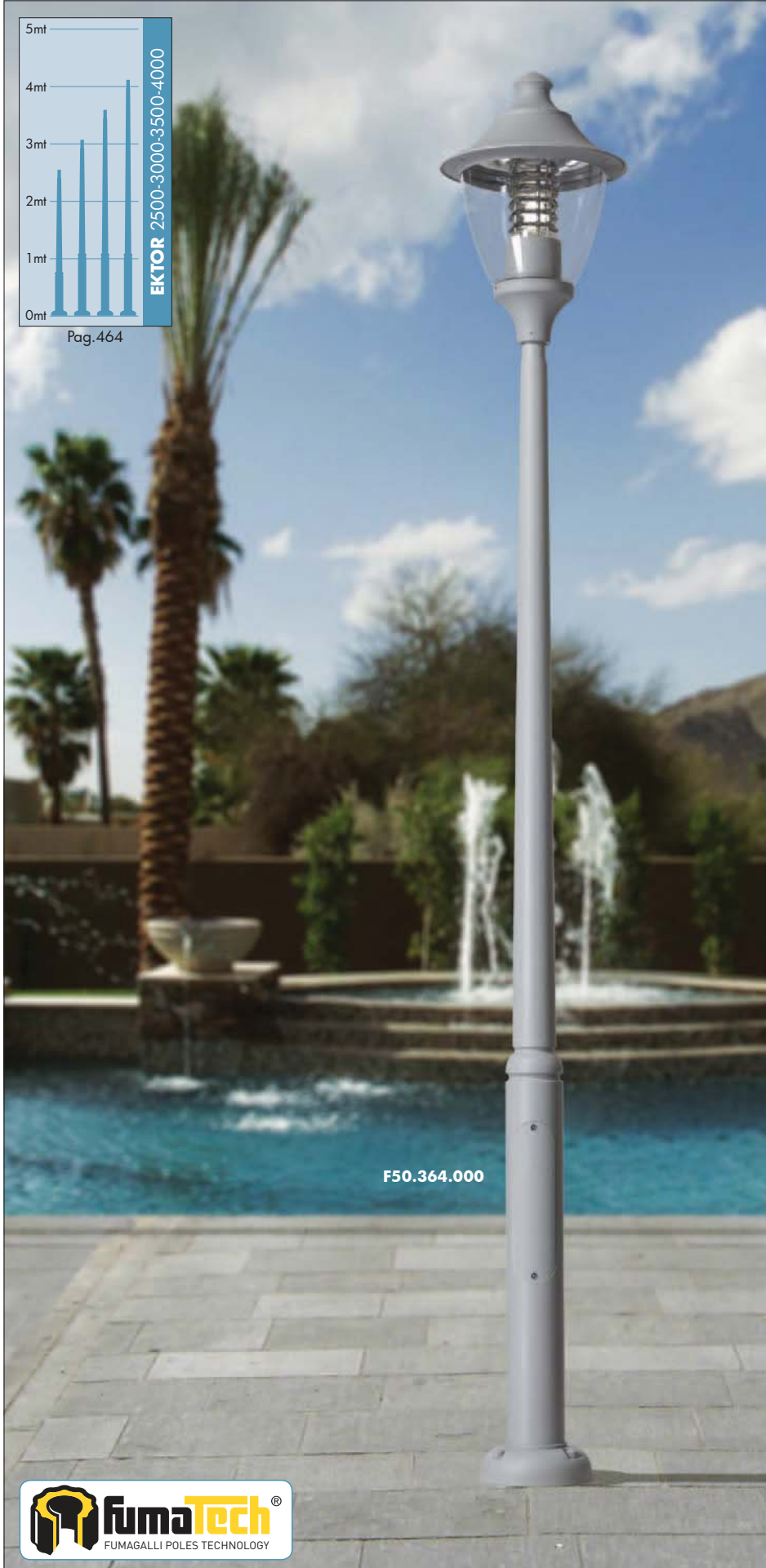

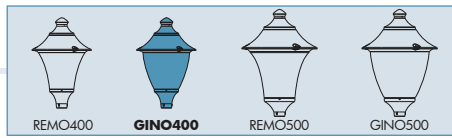

**MIDIPILAR/GINO400**  
F50.254

Pcs 1  
Kg 7,5  
mc 0,09

**NEW LOT/GINO400**  
F50.115

Pcs 1  
Kg 6,5  
mc 0,07

**EKTOR 3500/GINO400**  
F50.367.000

Pcs 1  
Kg 38,9  
mc 0,26

**GINO400**  
F50.000

Pcs 1  
Kg 5,7  
mc 0,06

**EKTOR 2500/GINO400**  
F50.361.000

Pcs 1  
Kg 25,9  
mc 0,21

**EKTOR 3000/GINO400**  
F50.364.000

Pcs 1  
Kg 35,9  
mc 0,24

**EKTOR 4000/GINO400**  
F50.371.000

Pcs 1  
Kg 41,9  
mc 0,29

BULKHEAD

FLOODLIGHT

IN-GROUND

BRICKLIGHT

BOLLARDS

GARDEN

URBAN CLASSIC

URBAN MODERN

HIGH-BAY

POST

LAMPS

EKTOR/**GINO 400**  
LARGE SIZE

BULKHEAD  
FLOODLIGHT  
IN-GROUND  
BRICKLIGHT  
BOLLARDS  
GARDEN  
URBAN CLASSIC  
URBAN MODERN  
HIGH-BAY  
POST  
LAMPS

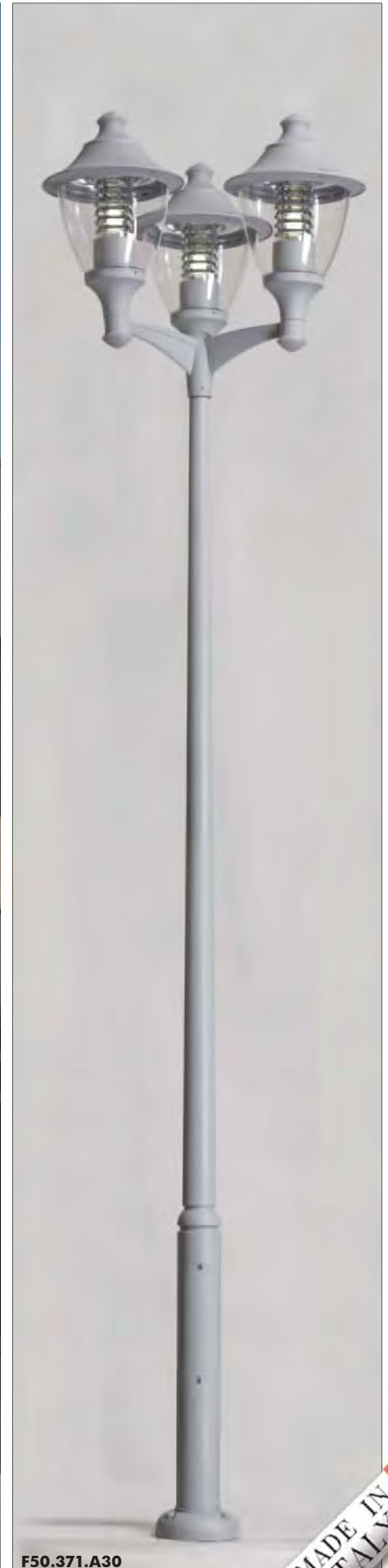
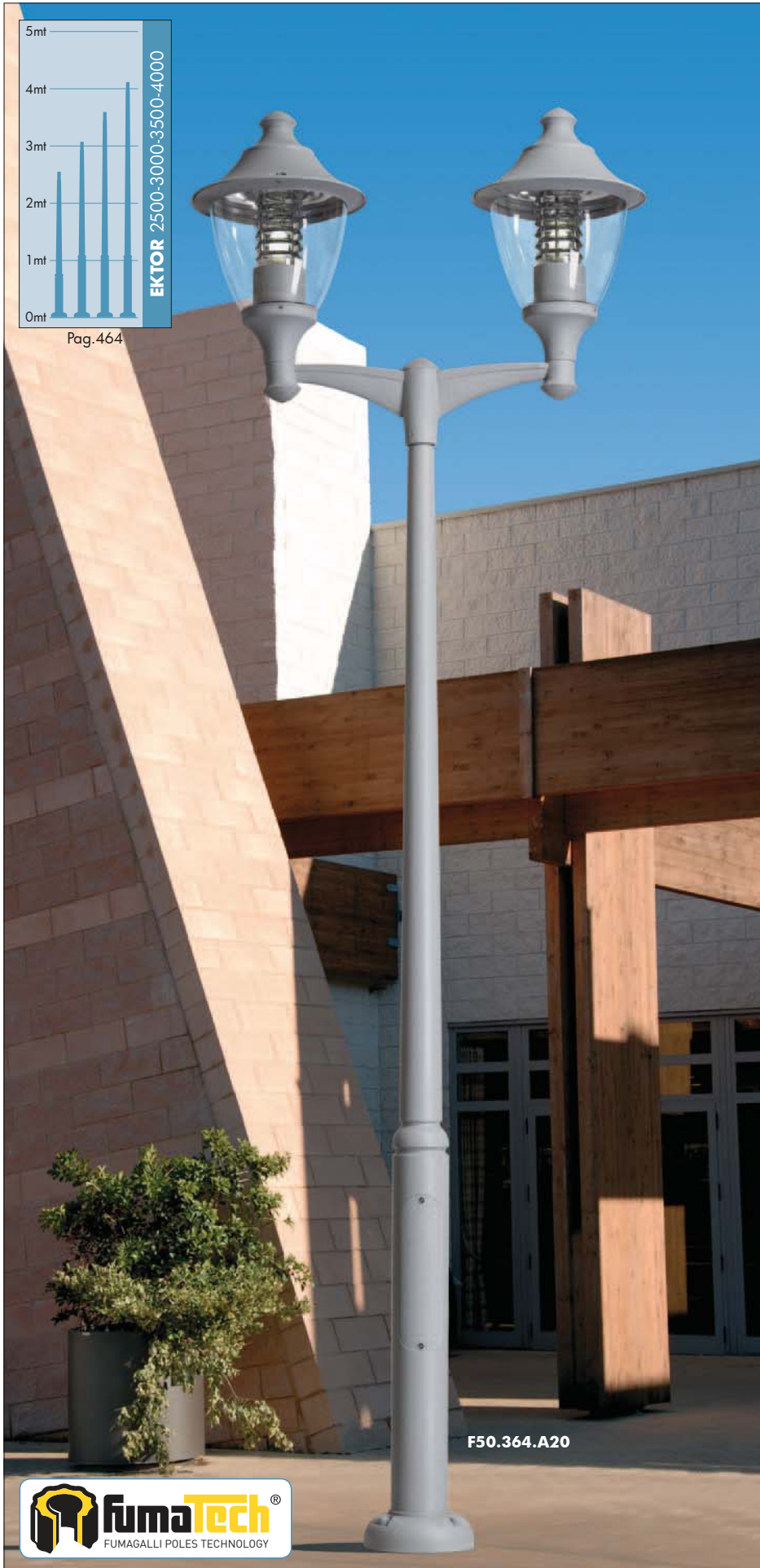

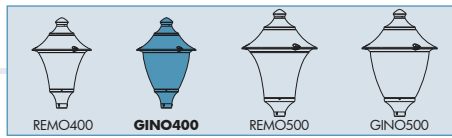

**EKTOR 3500 MIDIPILAR/GINO400 2L**    **EKTOR 4000 MIDIPILAR/GINO400 2L**

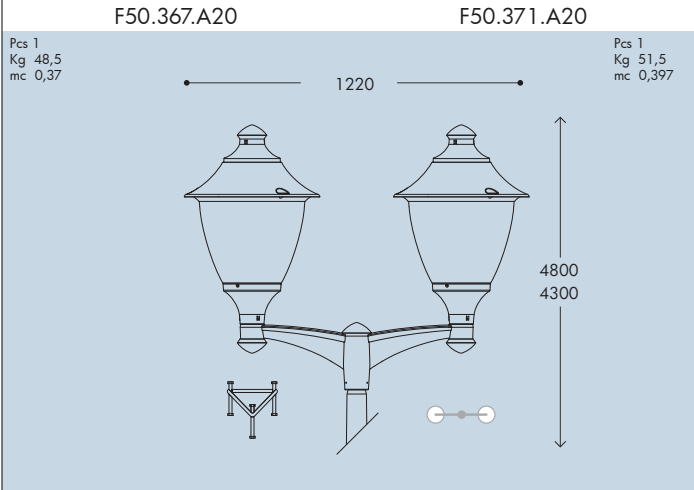

**EKTOR 3500 MIDIPILAR/GINO400 3L**    **EKTOR 4000 MIDIPILAR/GINO400 3L**

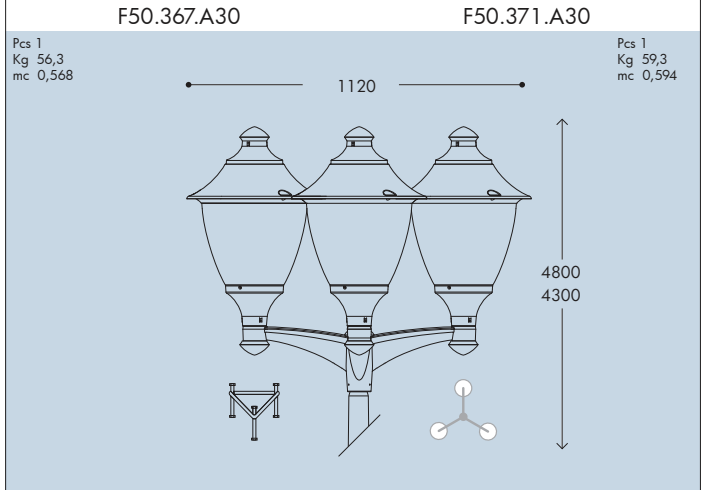

**EKTOR 2500 MIDIPILAR/GINO400 2L**    **EKTOR 3000 MIDIPILAR/GINO400 2L**

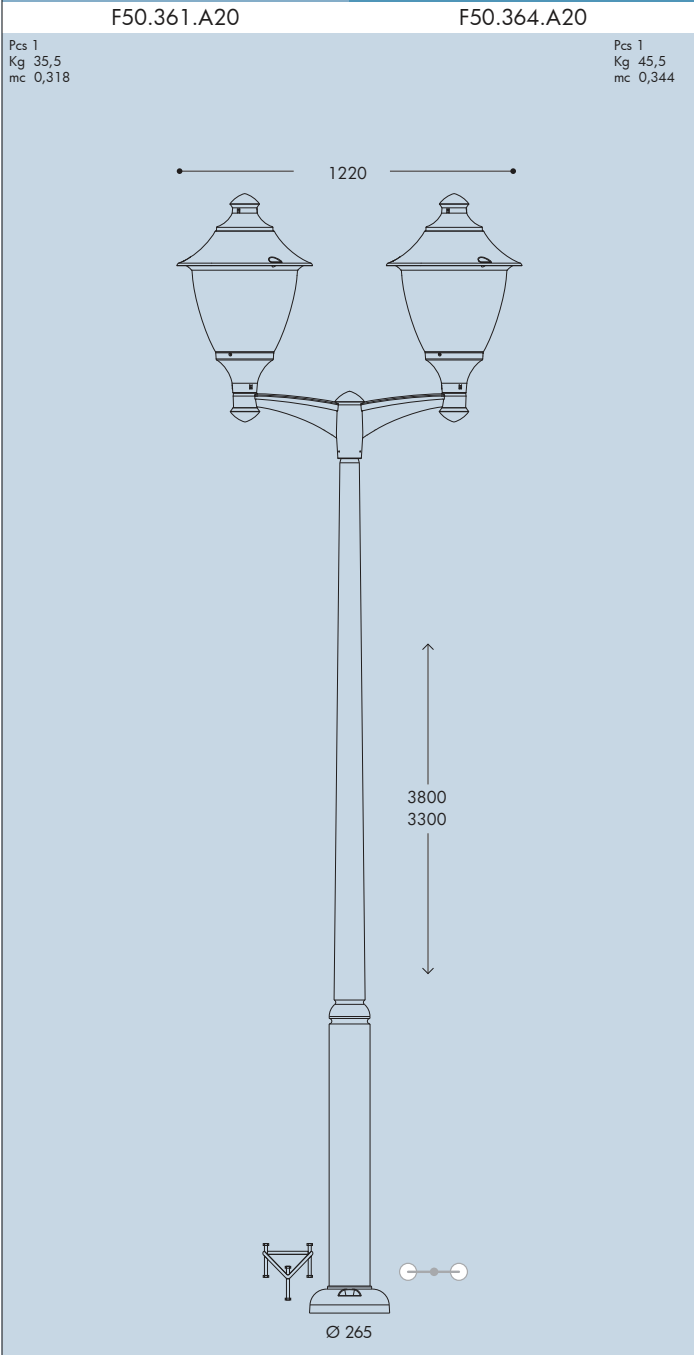

**EKTOR 2500 MIDIPILAR/GINO400 3L**    **EKTOR 3000 MIDIPILAR/GINO400 3L**

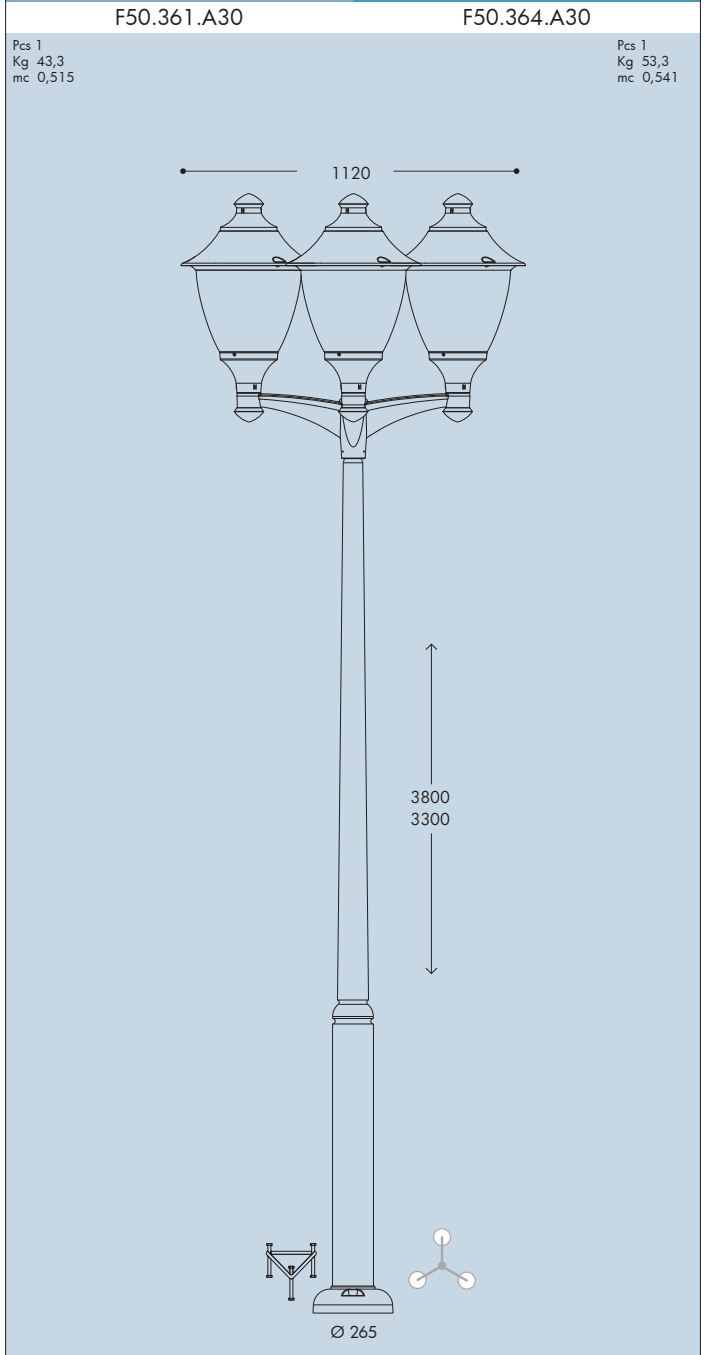

BULKHEAD

FLOODLIGHT

IN-GROUND

BRICKLIGHT

BOLLARDS

GARDEN

URBAN CLASSIC

URBAN MODERN

HIGH-BAY

POST

LAMPS



# AKILLE/GINO 400 LARGE SIZE

BULKHEAD  
FLOODLIGHT  
IN-GROUND  
BRICKLIGHT  
BOLLARDS  
GARDEN  
URBAN CLASSIC  
URBAN MODERN  
HIGH-BAY  
POST  
LAMPS



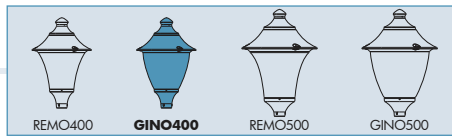

AKILLE 3500/ GINO400	AKILLE 4000/ GINO400
F50.417.000	F50.421.000
Pcs 1 Kg 38,9 mc 0,26	Pcs 1 Kg 41,9 mc 0,29

AKILLE 3500 MIDIPILAR/ GINO400 2L	AKILLE 4000 MIDIPILAR/ GINO400 2L
F50.417.A20	F50.421.A20
Pcs 1 Kg 48,5 mc 0,37	Pcs 1 Kg 51,5 mc 0,397

AKILLE 3500 MIDIPILAR/ GINO400 3L	AKILLE 4000 MIDIPILAR/ GINO400 3L
F50.417.A30	F50.421.A30
Pcs 1 Kg 56,3 mc 0,568	Pcs 1 Kg 59,3 mc 0,594

AKILLE 3000/GINO400
F50.414.000
Pcs 1 Kg 35,9 mc 0,24

AKILLE 3000 MIDIPILAR/GINO400 2L
F50.414.A20
Pcs 1 Kg 45,5 mc 0,344

AKILLE 3000 MIDIPILAR/GINO400 3L
F50.414.A30
Pcs 1 Kg 53,3 mc 0,541

BULKHEAD  
FLOODLIGHT  
IN-GROUND  
BRICKLIGHT  
BOLLARDS  
GARDEN  
URBAN CLASSIC  
URBAN MODERN  
HIGH-BAY  
POST  
LAMPS

# ECOVIVI 500

## GRAND SIZE

BULKHEAD  
FLOODLIGHT  
IN-GROUND  
BRICKLIGHT  
BOLLARDS  
GARDEN  
URBAN CLASSIC  
URBAN MODERN  
HIGH-BAY  
POST  
LAMPS

Modern luminaries made of shockproof resin material, UV-rays stabilized, rust and corrosion-free. Suitable for post top, wall and hanging installation. Supplied with flat diffuser granting no upward light emission. Provided with high temperature resistant ceiling suitable for horizontal bulb fixation and with aluminum reflector to optimize the light distribution. Designed according to the international regulations against light pollution (standard UNI 10819 - Installation area: Zone 1). Insulation class II, Protection rating IP65.

*Diffusore moderno realizzato in resina antiurto, stabilizzato ai raggi UV, inattaccabile da ruggine e corrosione. Idoneo per il montaggio a palo, a sospensione o a parete. Fornito con diffusore piatto per garantire assenza di emissioni di luce verso l'alto. Provvisto di soffitto ad alta resistenza al calore idoneo per il fissaggio orizzontale della lampadina e completo di parabola riflettente in alluminio per direzionare il flusso luminoso. Progettato in ottemperanza alle norme internazionali contro l'inquinamento luminoso (standard UNI 10819 - Area di installazione: Zona 1). Classe di isolamento II, grado di protezione IP65.*

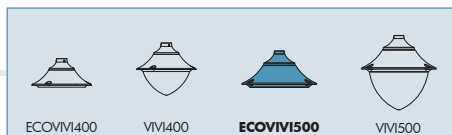

### ECOVIVI 500 E27 - E40 VERSION - COMPONENTS

IP65



**ROOF** made of shockproof resin material, UV-rays stabilized, rust and corrosion-free.

**TETTO** realizzato in resina antiurto, stabilizzata ai raggi UV, inattaccabile da ruggine e corrosione.

High temperature resistant **CEILING** made of white polycarbonate (PC), UV-rays stabilized, suitable for ballast fixation on its upper side and provided with E27 or E40 lampholder on its lower side. Bulb in horizontal position.

**SOFFITTO** realizzato in policarbonato bianco (PC) ad alta resistenza al calore, stabilizzato ai raggi UV, nella cui parte superiore vengono fissati i reattori. Fornito completo di portalamпада E27 o E40 atto a sostenere la lampadina in posizione orizzontale.



Parabolic **REFLECTOR** made of anodized aluminium, designed to optimize the light distribution and to limit the skyward dispersion of the luminous flux.

**PARABOLA** riflettente realizzata in alluminio anodizzato, progettata per ottimizzare la distribuzione del flusso luminoso e limitarne la dispersione verso il cielo.

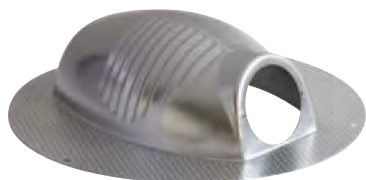

**DIFFUSER** with flat shape to avoid the skyward dispersion of the luminous flux, according to the international regulations against light pollution and in particular the standard UNI 108119. Made of UV-rays stabilized polycarbonate (PC) and available in clear and opal colour.

**DIFFUSORE** con configurazione piatta per evitare la dispersione verso il cielo del flusso luminoso, in ottemperanza alle norme internazionali sull'inquinamento luminoso ed in particolare la norma UNI 10819. Realizzato in policarbonato (PC) stabilizzato ai raggi UV e disponibile in colore trasparente o opale.



Decorative connection **RING** to be fixed on the luminaries diffuser.

**ANELLO** decorativo da fissare sul diffusore dell'apparecchio.



### ECOVIVI 500

EV6.000 \*



#### Dimensions and weight

Height: 300 mm  
Diameter: 600 mm  
Weight: 4,6 Kg  
Junction to support: diameter 60 mm  
Area expose to wind pressure:  
CxS = m<sup>2</sup> 0,0982

#### Moulded colours:

Black White Grey

#### Diffuser PC:

Clear Opal

### E27-E40



Luminaries supplied with E27 or E40 lampholder and provided as an option complete with ballast kit for SON-HQI lamps.

E27 (GLS-CFL-LED)	E27 Lampholder only	.E27
E27 WITH BALLAST KIT	SON 70W	.S70
	HQI 70W	.H70
E40 WITH BALLAST KIT	SON 100W	.S10
	HQI 100W	.H10
	SON 150W	.S15
	HQI 150W	.H15

### HORIZONTAL BULB

AGAINST LIGHT POLLUTION

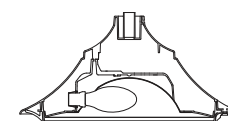

E27 - E40 VERSION

\* ADD THESE SUFFIXES TO THE REFERENCES MENTIONED IN THE CATALOGUE

### PHOTOMETRIC DATA SAMPLE

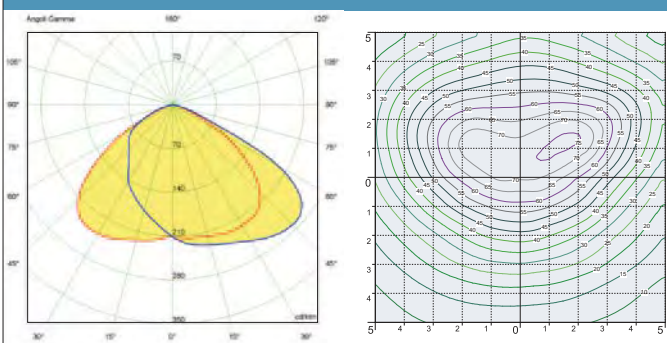

**ECOVIVI 500** clear HQI 150W.

POST height 5mt  
10x10mt area: average 38 lux

The photometric data for all the versions are available upon request or on our website.

# ECOVIVI 500 LED

## GRAND SIZE

Modern luminaries made of shockproof resin material, UV-rays stabilized, rust and corrosion-free. Suitable for post top, wall and hanging installation. Supplied with flat diffuser granting no upward light emission. Equipped with TÜV approved, long-life and efficient **GX53 LED modular system** in different wattages. Designed according to the international regulations against light pollution (standard UNI 10819 – Installation area: Zone 1). Insulation class II, Protection rating IP65.

*Diffusore moderno realizzato in resina antiurto, stabilizzato ai raggi UV, inattaccabile da ruggine e corrosione. Idoneo per il montaggio a palo, a sospensione o a parete. Fornito con diffusore piatto per garantire assenza di emissioni di luce verso l'alto. Provvisto di sistema modulare a LED GX53 approvato TÜV di lunga durata ed alta efficienza disponibile in diverse potenze. Progettato in ottemperanza alle norme internazionali contro l'inquinamento luminoso (standard UNI 10819 – Area di installazione: Zona 1). Classe di isolamento II, grado di protezione IP65.*



EV6.000.D9L





**ECOVIVI 500 LED VERSION - COMPONENTS**

**IP65**



**ROOF** made of shockproof resin material one piece only, UV-rays stabilized, rust and corrosion-free.

**TETTO** in un unico pezzo, realizzato in resina antiurto, stabilizzata ai raggi UV, inattaccabile da ruggine e corrosione.



**DIFFUSER** with flat shape to avoid the skyward dispersion of the luminous flux, according to the international regulations against light pollution and in particular the standard UNI 108119. Made of UV-rays stabilized polycarbonate (PC) and available in clear and opal colour.

**DIFFUSORE** con configurazione piatta per evitare la dispersione verso il cielo del flusso luminoso, in ottemperanza alle norme internazionali sull'inquinamento luminoso ed in particolare la norma UNI 10819. Realizzato in polycarbonato (PC), stabilizzato ai raggi UV e disponibile in colore trasparente o opale.



Decorative connection **RING** to be fixed on the luminaries diffuser.

**ANELLO** decorative di connessione da fissare sul diffusore dell'apparecchio.



**ECOVIVI 500 LED**

EV6.000 \*



**Dimensions and weight**

Height: 300 mm  
Diameter: 600 mm  
Weight: 6,4 Kg  
Junction to support: diameter 60 mm  
Area expose to wind pressure:  
CxS = m<sup>2</sup> 0,0982

**Moulded colours:**

Black  White  Grey

**Diffuser PC:**

Clear  Opal

**GX53 LED**



- **COST SAVING:** long-life and efficient LED light sources.
- **BUILT-IN DRIVER:** quick and easy lamp replacement
- **GREAT FLEXIBILITY:** GX53 standard lamp holder.
- **FUTURE-PROOFED LUMINARIES:** performances easy to upgrade to latest technology developments.
- **SUITABLE FOR OUTDOOR USE:** built-in driver fully protected against heat and humidity by silicone paste.

\*ADD. SUFFIX

Luminaries supplied with white resin CEILING provided with TÜV approved, long-life and efficient 9x GX53 LED lamps included. Each lamp can be quickly and easily replaced individually, making the luminaries maintenance very simple.



9x 7W <b>63W</b>	<b>7200 Lm</b>	4000 K	.C9L
		3000 K	.C9R
9x 10W <b>90W</b>	<b>10800 Lm</b>	4000 K	.D9L
		3000 K	.D9R

**LED LAMPS**



More technical details about TÜV approved Fumagalli LED Lamps on page 468.

\* ADD THESE SUFFIXES TO THE REFERENCES MENTIONED IN THE CATALOGUE

**PHOTOMETRIC DATA SAMPLE - ECOVIVI 500 LED**

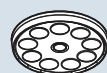
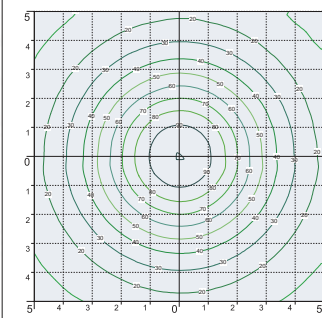
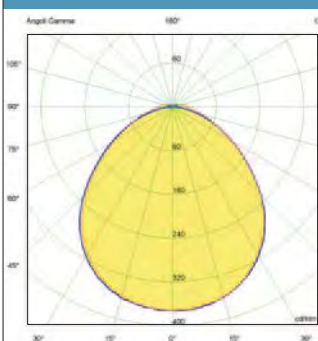

**SAVE -45%**

9x10W GX53 LED  
**90W**  
(power consumption)

Area: 10x10mt  
Height: 5mt  
**38 lux**



HQL150W  
**165W**  
(power consumption)

Area: 10x10mt  
Height: 5mt  
**38 lux**

**ECOVIVI 500 E40**

# EKTOR/ECOVIVI 500 GRAND SIZE

BULKHEAD  
FLOODLIGHT  
IN-GROUND  
BRICKLIGHT  
BOLLARDS  
GARDEN  
URBAN CLASSIC  
URBAN MODERN  
HIGH-BAY  
POST  
LAMPS

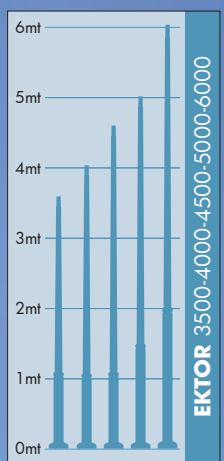

Pag.464



ECOVIVI 500 EV6.000	
Pcs 1 Kg 4,9 mc 0,06	

MARIO/ECOVIVI500 EV6.129	
Pcs 1 Kg 4,9 mc 0,09	

EKTOR 4500 PILAR/ECOVIVI500 1L EV6.374.P10	EKTOR 5000 PILAR/ECOVIVI500 1L EV6.377.P10
Pcs 1 Kg 48 mc 0,37	Pcs 1 Kg 51 mc 0,39

EKTOR 3500 PILAR/ECOVIVI500 1L EV6.367.P10	EKTOR 4000 PILAR/ECOVIVI500 1L EV6.371.P10
Pcs 1 Kg 42 mc 0,33	Pcs 1 Kg 45 mc 0,35



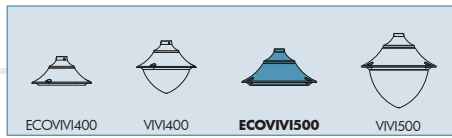

<b>EKTOR 4500 PILAR/ ECOVIVI500 2L</b> EV6.374.P20	<b>EKTOR 5000 PILAR/ ECOVIVI500 2L</b> EV6.377.P20
Pcs 1 Kg 55 mc 0,47	Pcs 1 Kg 58 mc 0,49

<b>EKTOR 3500 PILAR/ECOVIVI500 2L</b> EV6.367.P20	<b>EKTOR 4000 PILAR/ECOVIVI500 2L</b> EV6.371.P20
Pcs 1 Kg 49 mc 0,43	Pcs 1 Kg 52 mc 0,45

<b>EKTOR 6000 PILAR/ECOVIVI500 2L</b> EV6.384.P20
Pcs 1 Kg 73 mc 1,42

**NEW 6m POST**

<b>EKTOR 6000 PILAR/ECOVIVI500 1L</b> EV6.384.P10
Pcs 1 Kg 66 mc 1,32

**NEW 6m POST**

BULKHEAD  
FLOODLIGHT  
IN-GROUND  
BRICKLIGHT  
BOLLARDS  
GARDEN  
URBAN CLASSIC  
URBAN MODERN  
HIGH-BAY  
POST  
LAMPS



# AKILLE/ECOVIVI 500 GRAND SIZE

BULKHEAD  
FLOODLIGHT  
IN-GROUND  
BRICKLIGHT  
BOLLARDS  
GARDEN  
URBAN CLASSIC  
URBAN MODERN  
HIGH-BAY  
POST  
LAMPS

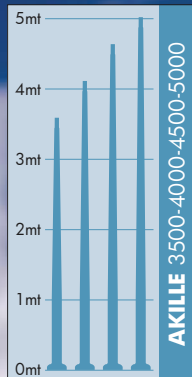

Pag.464



EV6.253.D9L

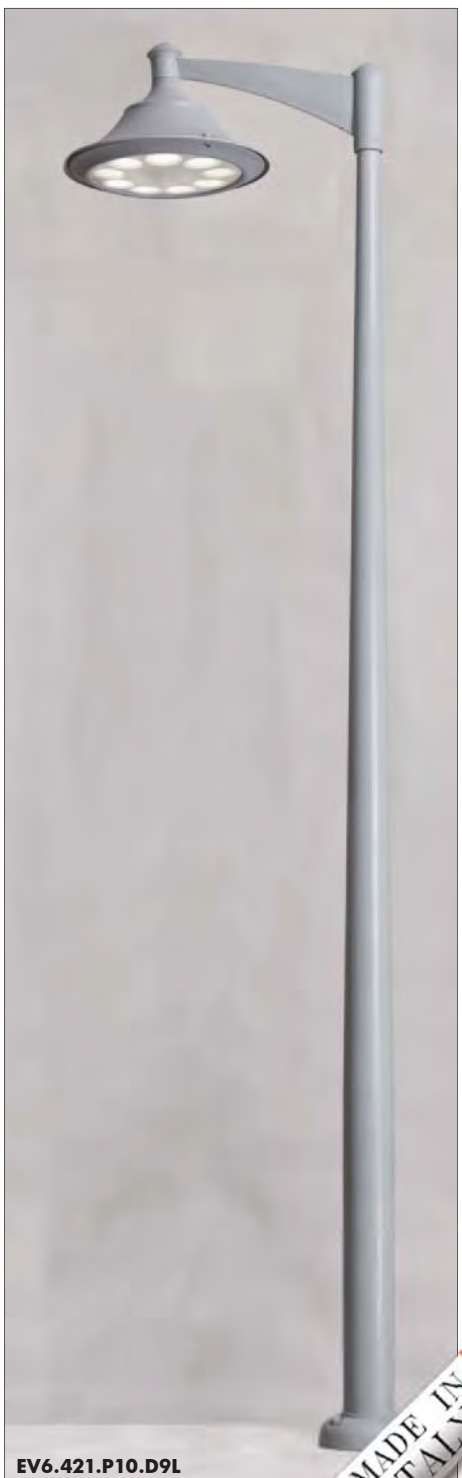

EV6.421.P10.D9L



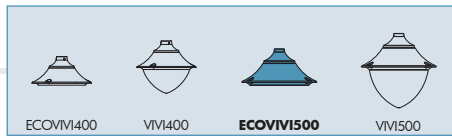

**NEW LOT/ECOVIVI500**  
**EV6.115**

Pcs 1  
Kg 4,9  
mc 0,09

600

410

**PILAR/ECOVIVI500**  
**EV6.253**

Pcs 1  
Kg 7,7  
mc 0,11

920

400

<b>AKILLE 4500 PILAR/ECOVIVI500 2L</b> <b>EV6.424.P20</b>	<b>AKILLE 5000 PILAR/ECOVIVI500 2L</b> <b>EV6.427.P20</b>
Pcs 1 Kg 55 mc 0,47	Pcs 1 Kg 58 mc 0,49
1800	
5220 4720	

<b>AKILLE 4500 PILAR/ECOVIVI500 1L</b> <b>EV6.424.P10</b>	<b>AKILLE 5000 PILAR/ECOVIVI500 1L</b> <b>EV6.427.P10</b>
Pcs 1 Kg 48 mc 0,37	Pcs 1 Kg 51 mc 0,39
1030	
5220 4720	
Ø 265	

<b>AKILLE 3500 PILAR/ECOVIVI500 1L</b> <b>EV6.417.P10</b>	<b>AKILLE 4000 PILAR/ECOVIVI500 1L</b> <b>EV6.421.P10</b>
Pcs 1 Kg 42 mc 0,33	Pcs 1 Kg 45 mc 0,35
1030	
4220 3720	
Ø 265	

<b>AKILLE 3500 PILAR/ECOVIVI500 2L</b> <b>EV6.417.P20</b>	<b>AKILLE 4000 PILAR/ECOVIVI500 2L</b> <b>EV6.421.P20</b>
Pcs 1 Kg 49 mc 0,43	Pcs 1 Kg 52 mc 0,45
1800	
4220 3720	
Ø 265	

BULKHEAD

FLOODLIGHT

IN-GROUND

BRICKLIGHT

BOLLARDS

GARDEN

URBAN CLASSIC

URBAN MODERN

HIGH-BAY

POST

LAMPS

# VIVI 500

## GRAND SIZE

Modern luminaries made of shockproof resin material, UV-rays stabilized, rust and corrosion-free. Suitable for post top, wall and hanging installation. Provided with high temperature resistant ceiling suitable for horizontal bulb fixation and with aluminum reflector to optimize the light distribution. Designed according to the international regulations against light pollution (standard UNI 10819). Insulation class II, Protection rating IP65.

*Diffusore moderno realizzato in resina antiurto, stabilizzato ai raggi UV, inattaccabile da ruggine e corrosione. Idoneo per il montaggio a palo, a sospensione o a parete. Fornito con soffitto ad alta resistenza al calore idoneo per il fissaggio orizzontale della lampadina e provvisto di parabola riflettente in alluminio per direzionare il flusso luminoso. Progettato in ottemperanza alle norme internazionali contro l'inquinamento luminoso (standard UNI 10819). Classe di isolamento II, grado di protezione IP65.*



BULKHEAD  
FLOODLIGHT  
IN-GROUND  
BRICKLIGHT  
BOLLARDS  
GARDEN  
URBAN CLASSIC  
URBAN MODERN  
HIGH-BAY  
POST  
LAMPS

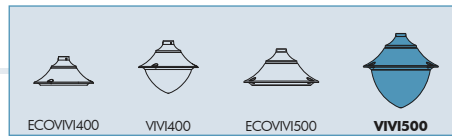

### VIVI 500 E27 - E40 VERSION - COMPONENTS

IP65



**ROOF** made of shockproof resin material, UV-rays stabilized, rust and corrosion-free.

**TETTO** realizzato in resina antiurto, stabilizzata ai raggi UV, inattaccabile da ruggine e corrosione.

High temperature resistant **CEILING** made of white polycarbonate (PC), UV-rays stabilized, suitable for ballast fixation on its upper side and provided with E27 or E40 lampholder on its lower side. Bulb in horizontal position.

**SOFFITTO** realizzato in policarbonato bianco (PC) ad alta resistenza al calore, stabilizzato ai raggi UV, nella cui parte superiore vengono fissati i reattori. Fornito completo di portalampada E27 o E40 atto a sostenere la lampadina in posizione orizzontale.

Parabolic **REFLECTOR** made of anodized aluminium, designed to optimize the light distribution and to limit the skyward dispersion of the luminous flux.

**PARABOLA** riflettente realizzata in alluminio anodizzato, progettata per ottimizzare la distribuzione del flusso luminoso e limitarne la dispersione verso il cielo.

**DIFFUSER** made of UV-rays stabilized polymethylmethacrylate (PMMA), one piece only, available in clear or opal colour.

**DIFFUSORE** realizzato in polimetilmetacrilato (PMMA) stabilizzato ai raggi UV, un pezzo unico, disponibile in colore trasparente o opale.

Decorative connection **RING** to be fixed on the luminaries diffuser.

**ANELLO** decorativo di connessione da fissare sul diffusore dell'apparecchio.



### VIVI 500

V60.000 \*



#### Dimensions and weight

Height: 600 mm

Diameter: 600 mm

Weight: 7,1 Kg

Junction to support: diameter 60 mm

Area expose to wind pressure:

CxS = m<sup>2</sup> 0,1932

#### Moulded colours:

Black White Grey

#### Diffuser PMMA:

Clear Opal

### E27-E40



Luminaries supplied with E27 or E40 lampholder and provided as an option complete with ballast kit for SON-HQI lamps.

E27 (GLS-CFL-LED)	E27 Lampholder only	.E27
E27 WITH BALLAST KIT	SON 70W	.S70
	HQI 70W	.H70
E40 WITH BALLAST KIT	SON 100W	.S10
	HQI 100W	.H10
	SON 150W	.S15
	HQI 150W	.H15

### HORIZONTAL BULB

AGAINST LIGHT POLLUTION

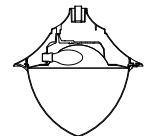

E27 - E40 VERSION

\* ADD THESE SUFFIXES TO THE REFERENCES MENTIONED IN THE CATALOGUE

### PHOTOMETRIC DATA SAMPLE

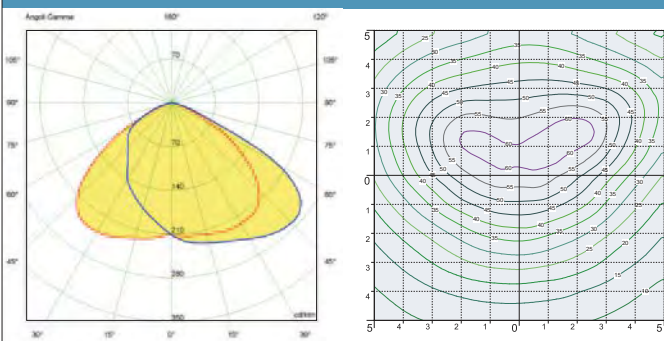

**VIVI 500** clear HQI 150W.

POST height 5mt  
10x10mt area: average 35 lux

The photometric data for all the versions are available upon request or on our website.

# VIVI 500 LED

## GRAND SIZE

Modern luminaries made of shockproof resin material, UV-rays stabilized, rust and corrosion-free. Suitable for post top, wall and hanging installation. Equipped with TÜV approved, long-life and efficient **GX53 LED modular system** in different wattages. Designed according to the international regulations against light pollution (standard UNI 10819). Insulation class II, Protection rating IP65.

*Diffusore moderno realizzato in resina antiurto, stabilizzato ai raggi UV, inattaccabile da ruggine e corrosione. Idoneo per il montaggio a palo, a sospensione o a parete. Provvisto di sistema modulare a LED GX53 approvato TÜV di lunga durata ed alta efficienza disponibile in diverse potenze. Progettato in ottemperanza alle norme internazionali contro l'inquinamento luminoso (standard UNI 10819). Classe di isolamento II, grado di protezione IP65.*

**V60.000.D9L**



BULKHEAD  
FLOODLIGHT  
IN-GROUND  
BRICKLIGHT  
BOLLARDS  
GARDEN  
URBAN CLASSIC  
URBAN MODERN  
HIGH-BAY  
POST  
LAMPS

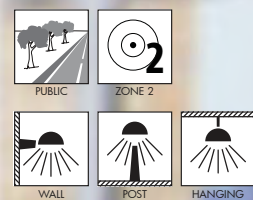
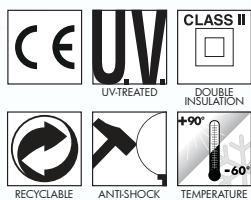

MADE IN ITALY

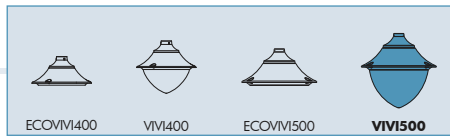

### VIVI 500 LED VERSION - COMPONENTS

IP65



**ROOF** made of shockproof resin material one piece only, UV-rays stabilized, rust and corrosion-free.

**TETTO** in un unico pezzo, realizzato in resina antiurto, stabilizzata ai raggi UV, inattaccabile da ruggine e corrosione.



**DIFFUSER** made of UV-rays stabilized polymethylmethacrylate (PMMA), one piece only, available in clear or opal colour.

**DIFFUSORE** realizzato in polimetilmetacrilato (PMMA) stabilizzato ai raggi UV, disponibile in colore trasparente o opale.



Decorative connection **RING** to be fixed on the luminaries diffuser.

**ANELLO** decorativo di connessione da fissare sul diffusore dell'apparecchio.

### VIVI 500 LED

V60.000 \*



#### Dimensions and weight

Height: 600 mm  
Diameter: 600 mm  
Weight: 8,9 Kg  
Junction to support: diameter 60 mm  
Area expose to wind pressure:  
CxS = m<sup>2</sup> 0,1932

#### Moulded colours:

Black White Grey

#### Diffuser PMMA:

Clear Opal

### GX53 LED



- **COST SAVING:** long-life and efficient LED light sources.
- **BUILT-IN DRIVER:** quick and easy lamp replacement
- **GREAT FLEXIBILITY:** GX53 standard lamp holder.
- **FUTURE-PROOFED LUMINARIES:** performances easy to upgrade to latest technology developments.
- **SUITABLE FOR OUTDOOR USE:** built-in driver fully protected against heat and humidity by silicone paste.

\*ADD. SUFFIX

Luminaries supplied with white resin CEILING provided with TÜV approved, long-life and efficient 9x GX53 LED lamps included. Each lamp can be quickly and easily replaced individually, making the luminaries maintenance very simple.



9x 7W  
**63W**

**7200 Lm**

4000 K .C9L

3000 K .C9R

9x 10W  
**90W**

**10800 Lm**

4000 K .D9L

3000 K .D9R

\* ADD THESE SUFFIXES TO THE REFERENCES MENTIONED IN THE CATALOGUE

### PHOTOMETRIC DATA SAMPLE - VIVI 500 LED

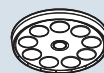
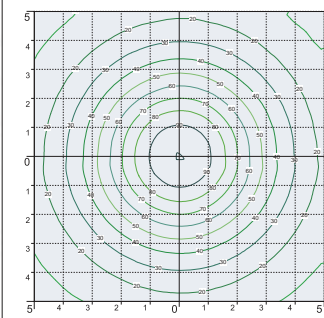
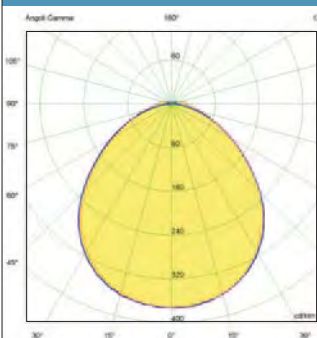

**SAVE -45%**

9x10W GX53 LED  
**90W**  
(power consumption)

Area: 10x10mt  
Height: 5mt  
**34 lux**



**HQI 150W**  
**165W**  
(power consumption)

Area: 10x10mt  
Height: 5mt  
**35 lux**

### VIVI 500 E40

# EKTOR/VIVI 500 GRAND SIZE

BULKHEAD  
FLOODLIGHT  
IN-GROUND  
BRICKLIGHT  
BOLLARDS  
GARDEN  
URBAN CLASSIC  
URBAN MODERN  
HIGH-BAY  
POST  
LAMPS

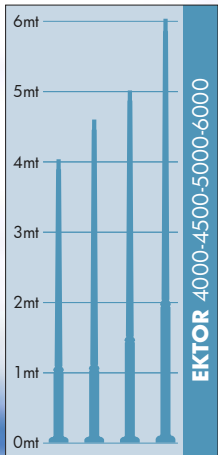

Pag. 464



V60.371.P20.D9L

EKTOR 4500 PILAR/VM500 1L V60.374.P10	EKTOR 5000 PILAR/VM500 1L V60.377.P10
Pcs 1 Kg 51,3 mc 0,40	Pcs 1 Kg 54,3 mc 0,43

EKTOR 4000 PILAR/VIVI500 1L V60.371.P10
Pcs 1 Kg 48,3 mc 0,37

VIVI 500 V60.000
Pcs 1 Kg 7,1 mc 0,10

MARIO/VIVI500 V60.129
Pcs 1 Kg 7,1 mc 0,11

MADE IN ITALY

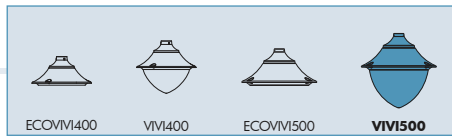

<b>EKTOR 4500 PILAR/ VIVI500 2L</b>	<b>EKTOR 5000 PILAR/ VIVI500 2L</b>
V60.374.P20	V60.377.P20
Pcs 1 Kg 60,2 mc 0,57	Pcs 1 Kg 63,2 mc 0,60

<b>EKTOR 4000 PILAR/VIVI500 2L</b>
V60.371.P20
Pcs 1 Kg 57,2 mc 0,54

<b>EKTOR 6000 PILAR/VIVI500 2L</b>
V60.384.P20
Pcs 1 Kg 78,2 mc 1,46

**NEW 6m POST**

<b>EKTOR 6000 PILAR/VIVI500 1L</b>
V60.384.P10
Pcs 1 Kg 69,3 mc 1,36

**NEW 6m POST**



# AKILLE/VIVI 500 GRAND SIZE

BULKHEAD

FLOODLIGHT

IN-GROUND

BRICKLIGHT

BOLLARDS

GARDEN

URBAN CLASSIC

URBAN MODERN

HIGH-BAY

POST

LAMPS

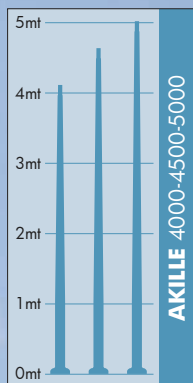

Pag. 464



MADE IN ITALY

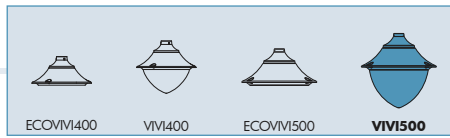

**PILAR/VIVI500**  
**V60.253**

Pcs 1  
Kg 12,3  
mc 0,15

920

650

<b>AKILLE 4500</b> <b>PILAR/VIVI500 1L</b> <b>V60.424.P10</b>	<b>AKILLE 5000</b> <b>PILAR/VIVI500 1L</b> <b>V60.427.P10</b>
Pcs 1 Kg 51,3 mc 0,40	Pcs 1 Kg 54,3 mc 0,43

1030

5220  
4720

<b>AKILLE 4500 PILAR/VIVI500 2L</b> <b>V60.424.P20</b>	<b>AKILLE 5000 PILAR/VIVI500 2L</b> <b>V60.427.P20</b>
Pcs 1 Kg 60,2 mc 0,57	Pcs 1 Kg 63,2 mc 0,60

1800

5220  
4720

**NEW LOT/VIVI500**  
**V60.115**

Pcs 1  
Kg 8,7  
mc 0,13

600

710

**AKILLE 4000 PILAR/VIVI500 1L**  
**V60.421.P10**

Pcs 1  
Kg 48,3  
mc 0,37

1030

4220

Ø 265

**AKILLE 4000 PILAR/VIVI500 2L**  
**V60.421.P20**

Pcs 1  
Kg 57,2  
mc 0,54

1800

4220

Ø 265

BULKHEAD

FLOODLIGHT

IN-GROUND

BRICKLIGHT

BOLLARDS

GARDEN

URBAN CLASSIC

URBAN MODERN

HIGH-BAY

POST

LAMPS

# BEPPE 500

## GRAND SIZE

Modern luminaries made of shockproof resin material, UV-rays stabilized, rust and corrosion-free. Suitable for post top or wall installation. Provided with high temperature resistant ceiling suitable for ballast fixation and with aluminum reflector to optimize the light distribution. Designed according to the international regulations against light pollution (standard UNI 10819). Insulation class II, Protection rating IP65.

*Diffusore moderno realizzato in resina antiurto, stabilizzato ai raggi UV, inattaccabile da ruggine e corrosione. Idoneo per il montaggio a palo o a parete. Fornito con soffitto ad alta resistenza al calore idoneo per il fissaggio dei reattori e provvisto di parabola riflettente in alluminio per dirigere il flusso luminoso. Progettato in ottemperanza alle norme internazionali contro l'inquinamento luminoso (standard UNI 10819). Classe di isolamento II, grado di protezione IP65.*





**BEPPE 500 E27 - E40 VERSION - COMPONENTS**

IP65



**ROOF** complete with decorative pinnacle made of shockproof resin material, UV-rays stabilized, rust and corrosion-free.

**TETTO** completo di pinnacolo decorativo realizzato in resina antiurto, stabilizzata ai raggi UV, inattaccabile da ruggine e corrosione.

High temperature resistant **CEILING** made of white polycarbonate (PC), UV-rays stabilized, suitable for ballast fixation on its upper side and provided with E27 or E40 lampholder on its lower side. Bulb in horizontal position.

**SOFFITTO** realizzato in polycarbonato bianco (PC) ad alta resistenza al calore, stabilizzato ai raggi UV, nella cui parte superiore vengono fissati i reattori. Fornito completo di portalampada E27 o E40 atto a sostenere la lampadina in posizione orizzontale.

Parabolic **REFLECTOR** made of anodized aluminium, designed to optimize the light distribution and to limit the skyward dispersion of the luminous flux.

**PARABOLA** riflettente realizzata in alluminio anodizzato, progettata per ottimizzare la distribuzione del flusso luminoso e limitarne la dispersione verso il cielo.

**DIFFUSER** made of UV-rays stabilized polymethylmethacrylate (PMMA), one piece only, available in clear or opal colour.

**DIFFUSORE** realizzato in polimetilmetacrilato (PMMA) stabilizzato ai raggi UV, un pezzo unico, disponibile in colore trasparente o opale.

**CAGE** for post top installation complete with connection ring (one piece only) to be fixed on the luminaries diffuser.

**BIPODE** in un unico pezzo completo di anello di connessione da fissare sul diffusore dell'apparecchio.

**BEPPE 500**

P60.000 \*



**Dimensions and weight**

Height: 850 mm  
Diameter: 600 mm  
Weight: 8,9 Kg  
Junction to support: diameter 60 mm  
Area expose to wind pressure:  
CxS = m<sup>2</sup> 0,246

**Moulded colours:**

Black  White  Grey

**Diffuser PMMA:**

Clear  Opal

**E27-E40**

\* ADD. SUFFIX



Luminaries supplied with E27 or E40 lampholder and provided as an option complete with ballast kit for SON-HQI lamps.

<b>E27</b> (GLS-CFL-LED)	E27 Lampholder only	.E27
	<b>E27</b> WITH BALLAST KIT	SON 70W .S70 HQI 70W .H70
<b>E40</b> WITH BALLAST KIT	SON 100W	.S10
	HQI 100W	.H10
	SON 150W	.S15
	HQI 150W	.H15

\* ADD THESE SUFFIXES TO THE REFERENCES MENTIONED IN THE CATALOGUE

**PHOTOMETRIC DATA SAMPLE**

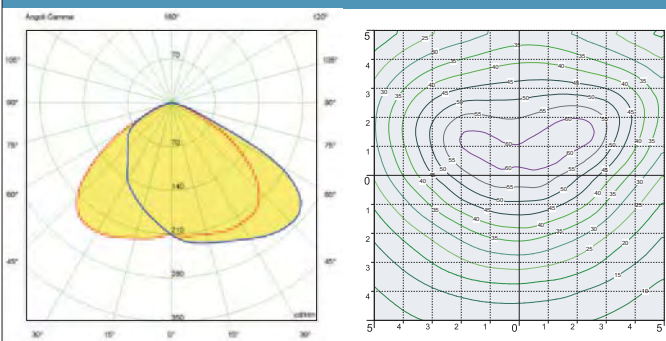

**BEPPE 500** clear HQI 150W.

POST height 5mt  
10x10mt area: average 31 lux

The photometric data for all the versions are available upon request or on our website.

# BEPPE 500 LED

## GRAND SIZE

Modern luminaries made of shockproof resin material, UV-rays stabilized, rust and corrosion-free. Suitable for post top or wall installation. Equipped with TÜV approved, long-life and efficient **GX53 LED modular system** in different wattages. Designed according to the international regulations against light pollution (standard UNI 10819). Insulation class II, Protection rating IP65.

*Diffusore moderno realizzato in resina antiurto, stabilizzato ai raggi UV, inattaccabile da ruggine e corrosione. Idoneo per il montaggio a palo o a parete. Provvisto di **sistema modulare a LED GX53** approvato TÜV di lunga durata ed alta efficienza disponibile in diverse potenze. Progettato in ottemperanza alle norme internazionali contro l'inquinamento luminoso (standard UNI 10819). Classe di isolamento II, grado di protezione IP65.*



P60.000.D9L

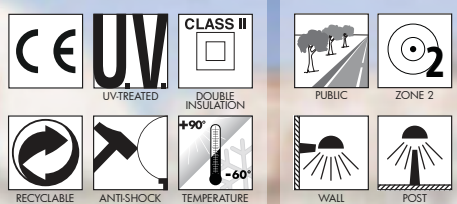

BULKHEAD

FLOODLIGHT

IN-GROUND

BRICKLIGHT

BOLLARDS

GARDEN

URBAN CLASSIC

URBAN MODERN

HIGH-BAY

POST

LAMPS



**BEPPE 500 LED VERSION - COMPONENTS**

**IP65**



**ROOF** complete with decorative pinnacle made of shockproof resin material one piece only, UV-rays stabilized, rust and corrosion-free.

**TETTO** completo di pinnacolo decorativo in un unico pezzo, realizzato in resina antiurto, stabilizzata ai raggi UV, inattaccabile da ruggine e corrosione

**DIFFUSER** made of UV-rays stabilized polymethylmethacrylate (PMMA), one piece only, available in clear or opal colour.

**DIFFUSORE** realizzato in polimetilmetacrilato (PMMA) stabilizzato ai raggi UV, disponibile in colore trasparente o opale.

**CAGE** for post top installation complete with connection ring (one piece only) to be fixed on the luminaries diffuser.

**BIPODE** in un unico pezzo completo di anello di connessione da fissare sul diffusore dell'apparecchio.

**BEPPE 500 LED**

P60.000 \*



**Dimensions and weight**

Height: 850 mm  
Diameter: 600 mm  
Weight: 10,7 Kg  
Junction to support: diameter 60 mm  
Area expose to wind pressure:  
CxS = m<sup>2</sup> 0,246

**Moulded colours:**

- Black
  - White
  - Grey
- Diffuser PMMA:**
- Clear
  - Opal

**GX53 LED**



- **COST SAVING:** long-life and efficient LED light sources.
- **BUILT-IN DRIVER:** quick and easy lamp replacement
- **GREAT FLEXIBILITY:** GX53 standard lamp holder.
- **FUTURE-PROOFED LUMINARIES:** performances easy to upgrade to latest technology developments.
- **SUITABLE FOR OUTDOOR USE:** built-in driver fully protected against heat and humidity by silicone paste.

\*ADD. SUFFIX

Luminaries supplied with white resin CEILING provided with TÜV approved, long-life and efficient 9x GX53 LED lamps included. Each lamp can be quickly and easily replaced individually, making the luminaries maintenance very simple.



9x 7W <b>63W</b>	<b>7200 Lm</b>	4000 K	.C9L
		3000 K	.C9R
9x 10W <b>90W</b>	<b>10800 Lm</b>	4000 K	.D9L
		3000 K	.D9R

**LED LAMPS**

More technical details about TÜV approved Fumagalli LED Lamps on page 468.



\* ADD THESE SUFFIXES TO THE REFERENCES MENTIONED IN THE CATALOGUE

**PHOTOMETRIC DATA SAMPLE - BEPPE 500 LED**

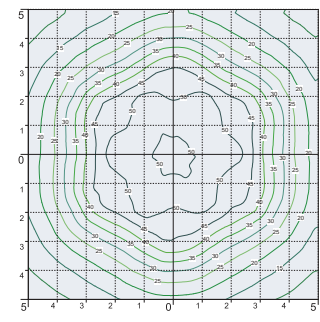
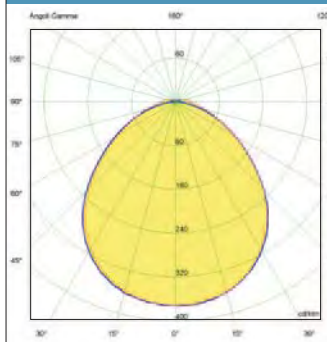

**SAVE -45%**

9x10W GX53 LED  
**90W**  
(power consumption)

Area: 10x10mt  
Height: 5mt  
**31 lux**

**BEPPE 500 E40**

HQI 150W  
**165W**  
(power consumption)

Area: 10x10mt  
Height: 5mt  
**31 lux**

EKTOR/**BEPPE 500**  
GRAND SIZE

BULKHEAD  
FLOODLIGHT  
IN-GROUND  
BRICKLIGHT  
BOLLARDS  
GARDEN  
URBAN CLASSIC  
URBAN MODERN  
HIGH-BAY  
POST  
LAMPS

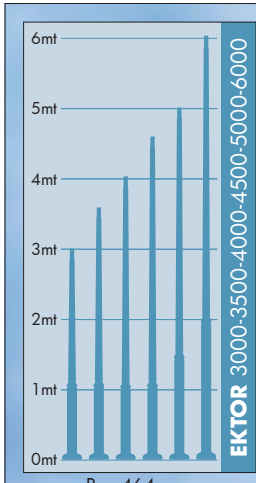

Pag.464



P60.371



P60.371.D9L

MADE IN ITALY



**EKTOR 6000/BEPPE500**  
P60.384.000

Pcs 1  
Kg 66,8  
mc 1,41

600

NEW 6m POST

6735

400

**EKTOR 5000/BEPPE500**  
P60.377.000

Pcs 1  
Kg 51,8  
mc 0,48

600

5735

Ø 265

<b>EKTOR 4000/ BEPPE500</b>	<b>EKTOR 4500/ BEPPE500</b>
P60.371.000	P60.374.000
Pcs 1 Kg 45,8 mc 0,43	Pcs 1 Kg 48,8 mc 0,46

600

5235  
4735

Ø 265

**BEPPE500**  
P60.000

Pcs 1  
Kg 8,9  
mc 0,20

600

850

Ø 60

<b>EKTOR 3000/ BEPPE500</b>	<b>EKTOR 3500/ BEPPE500</b>
P60.364.000	P60.367.000
Pcs 1 Kg 39,8 mc 0,38	Pcs 1 Kg 42,8 mc 0,40

600

4235  
3735

Ø 265

BULKHEAD  
FLOODLIGHT  
IN-GROUND  
BRICKLIGHT  
BOLLARDS  
GARDEN  
URBAN CLASSIC  
URBAN MODERN  
HIGH-BAY  
POST  
LAMPS



AKILLE/**BEPPE 500**  
GRAND SIZE

BULKHEAD  
FLOODLIGHT  
IN-GROUND  
BRICKLIGHT  
BOLLARDS  
GARDEN  
URBAN CLASSIC  
URBAN MODERN  
HIGH-BAY  
POST  
LAMPS

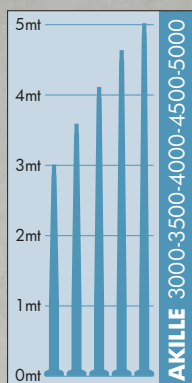

Pag.464

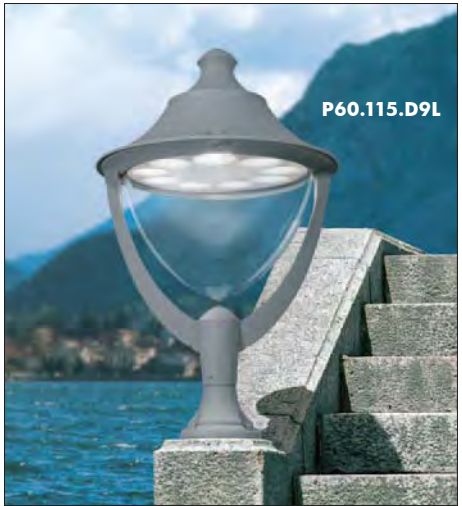

MADE IN ITALY



**AKILLE 5000/BEPPE500**  
P60.427.000

Pcs 1  
Kg 51,8  
mc 0,48

600

5735

Ø 265

AKILLE 4000/ BEPPE500	AKILLE 4500/ BEPPE500
P60.421.000	P60.424.000
Pcs 1 Kg 45,8 mc 0,43	Pcs 1 Kg 48,8 mc 0,46

600

5235  
4735

Ø 265

AKILLE 3000/ BEPPE500	AKILLE 3500/ BEPPE500
P60.414.000	P60.417.000
Pcs 1 Kg 39,8 mc 0,38	Pcs 1 Kg 42,8 mc 0,40

600

4235  
3735

Ø 265

**PILAR/BEPPE500**  
P60.253

Pcs 1  
Kg 11,4  
mc 0,24

920

1250

**NEW LOT/BEPPE500**  
P60.115

Pcs 1  
Kg 9,1  
mc 0,21

600

960

# REMO 500

## GRAND SIZE

- BULKHEAD
- FLOODLIGHT
- IN-GROUND
- BRICKLIGHT
- BOLLARDS
- GARDEN
- URBAN CLASSIC
- URBAN MODERN
- HIGH-BAY
- POST
- LAMPS

Modern luminaries made of shockproof resin material, UV-rays stabilized, rust and corrosion-free. Suitable for post top or wall installation. Provided with aluminum reflector to optimize the light distribution. Base equipped with E27 lampholder prepared for ballast and louvre fixation. Insulation class II, Protection rating IP65.

*Diffusore moderno realizzato in resina antiurto, stabilizzato ai raggi UV, inattaccabile da ruggine e corrosione. Idoneo per il montaggio a palo o a parete. Provvisto di parabola riflettente in alluminio per direzionare il flusso luminoso. Base con portalampada E27 predisposta per il fissaggio dei reattori e del frangiluce. Idoneo per il montaggio a palo e a parete. Classe di isolamento II, grado di protezione IP65.*



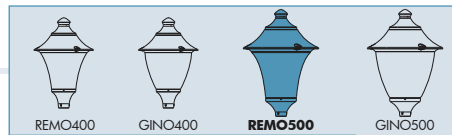

**REMO 500 E27 - E40 VERSION - COMPONENTS**



**IP65**



**ROOF** complete with decorative pinnacle made of shockproof resin material, UV-rays stabilized, rust and corrosion-free.

**TETTO** completo di pinnacolo decorativo, realizzato in resina antiurto, stabilizzato ai raggi UV, inattaccabile da ruggine e corrosione.

Parabolic **REFLECTOR** made of anodized aluminium and fixed under the luminaries roof, designed to optimize the light efficiency performance and to allow a uniform light distribution.

**PARABOLA** riflettente realizzata in alluminio anodizzato, fissata sotto il tetto del diffusore, progettata per ottimizzare il rendimento luminoso e permettere una uniforme distribuzione della luce.

**DIFFUSER** made of UV-rays stabilized polymethylmethacrylate (PMMA), one piece only, available in clear or opal colour.

**DIFFUSORE** realizzato in polimetilmetacrilato (PMMA) stabilizzato ai raggi UV, un pezzo unico, disponibile in colore trasparente o opale.

Chrome aluminium **LOUVRE** with a laminar symmetrical optic system to direct the lighting output and to get a lower dazzle (optional).

**FRANGILUCE** in alluminio cromato con sistema ottico lamellare a ripartizione simmetrica per orientare il fascio di luce e ridurre l'abbagliamento (opzionale).

Resin **BASE** consisting of a support (Ø 60mm) and of a cover suitable for ballast kit fixation on its lower side and provided with E27 or E40 lampholder on its upper side. A rubber gasket assures the protection of the electrical accessories seat against external agents.

**BASE** in resina composta da un supporto e da un coperchio nella cui parte inferiore possono essere fissati i reattori e nella cui parte superiore si trova l'alloggiamento per il portalampada E27 o E40 (incluso). Una guarnizione in gomma garantisce la protezione dell'alloggiamento degli accessori elettrici dagli agenti esterni.

**REMO 500**

R60.000 \*



**Dimensions and weight**

Height: 850 mm  
Diameter: 600 mm  
Weight: 8,5 Kg  
Junction to support: diameter 60 mm  
Area expose to wind pressure:  
CxS = m<sup>2</sup> 0,238

**Moulded colours:**

Black White Grey

**Diffuser PMMA:**

Clear Opal

**CHROME ALUMINIUM LOUVRE**

H.FC6 open  
Upward position



**E27-E40**

\* ADD. SUFFIX



Luminaries supplied with E27 or E40 lampholder and provided as an option complete with ballast kit for SON-HQI lamps.

E27 (GLS-CFL-LED)	E27 Lampholder only	.E27	
	SON 70W	.S70	
E27 WITH BALLAST KIT	HQI 70W	.H70	
	SON 100W	.S10	
E40 WITH BALLAST KIT	HQI 100W	.H10	
	SON 150W	.S15	
	HQI 150W	.H15	

\* ADD THESE SUFFIXES TO THE REFERENCES MENTIONED IN THE CATALOGUE

**PHOTOMETRIC DATA SAMPLE**

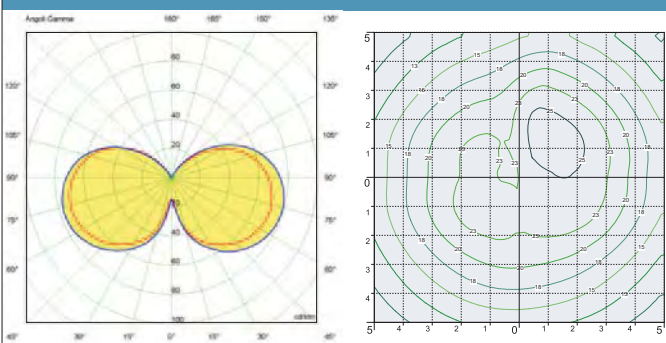

**REMO 500** clear HQI 150W.

POST height 5mt  
10x10mt area: average 19 lux

The photometric data for all the versions are available upon request or on our website.

# REMO 500 LED

## GRAND SIZE

Modern luminaries made of shockproof resin material, UV-rays stabilized, rust and corrosion-free. Suitable for post top or wall installation. Equipped with TÜV approved, long-life and efficient **GX53 LED modular system** in different wattages. Insulation class II, Protection rating IP65.

*Diffusore moderno realizzato in resina antiurto, stabilizzato ai raggi UV, inattaccabile da ruggine e corrosione. Idoneo per il montaggio a palo o a parete. Provvisto di **sistema modulare a LED GX53** approvato TÜV di lunga durata ed alta efficienza disponibile in diverse potenze. Classe di isolamento II, grado di protezione IP65.*



R60.000.D9L

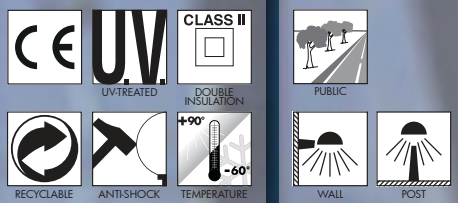

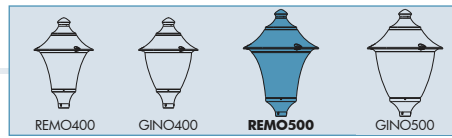

**REMO 500 LED VERSION - COMPONENTS**

**IP65**



**ROOF** complete with decorative pinnacle made of shockproof resin material, UV-rays stabilized, rust and corrosion-free.

**TETTO** completo di pinnacolo decorativo, realizzato in resina antiurto, stabilizzata ai raggi UV, inattaccabile da ruggine e corrosione.

**DIFFUSER** made of UV-rays stabilized polymethylmethacrylate (PMMA), one piece only, available in clear or opal colour.

**DIFFUSORE** realizzato in polimetilmetacrilato (PMMA) stabilizzato ai raggi UV, disponibile in colore trasparente o opale.

Decorative connection **RING** to be fixed on the luminaries diffuser.

**ANELLO** decorativo di connessione da fissare sul diffusore dell'apparecchio.

**BASE** made in shockproof resin material consisting of a support for post top installation (Ø 60mm) and of a white resin **CONE REFLECTOR**, to direct downwards the lighting output. A silicone rubber gasket assure the protection against external agents.

**BASE** dell'apparecchio realizzata in resina antiurto composta da un supporto per permettere il fissaggio dell'apparecchio a palo (Ø 60mm) e da un **CONO** riflettente in resina bianca per indirizzare verso il basso il flusso luminoso. Una guarnizione in gomma silconica garantisce la protezione dagli agenti esterni.

**REMO 500 LED**

R60.000 \*



**Dimensions and weight**

Height: 850 mm  
Diameter: 600 mm  
Weight: 10,3 Kg  
Junction to support: diameter 60 mm  
Area expose to wind pressure:  
CxS = m<sup>2</sup> 0,238

**Moulded colours:**

Black  White  Grey

**Diffuser PMMA:**

Clear  Opal

**GX53 LED**



- **COST SAVING:** long-life and efficient LED light sources.
- **BUILT-IN DRIVER:** quick and easy lamp replacement
- **GREAT FLEXIBILITY:** GX53 standard lamp holder.
- **FUTURE-PROOFED LUMINARIES:** performances easy to upgrade to latest technology developments.
- **SUITABLE FOR OUTDOOR USE:** built-in driver fully protected against heat and humidity by silicone paste.

\*ADD. SUFFIX

Luminaries supplied with white resin CEILING provided with TÜV approved, long-life and efficient 9x GX53 LED lamps included. Each lamp can be quickly and easily replaced individually, making the luminaries maintenance very simple.



9x 7W <b>63W</b>	<b>7200 Lm</b>	4000 K	.C9L
		3000 K	.C9R
9x 10W <b>90W</b>	<b>10800 Lm</b>	4000 K	.D9L
		3000 K	.D9R

**LED LAMPS**



More technical details about TÜV approved Fumagalli LED Lamps on page 468.

\* ADD THESE SUFFIXES TO THE REFERENCES MENTIONED IN THE CATALOGUE

**PHOTOMETRIC DATA SAMPLE - REMO 500 LED**

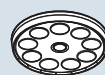
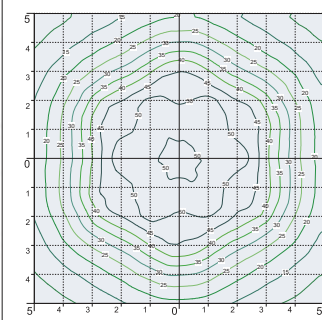
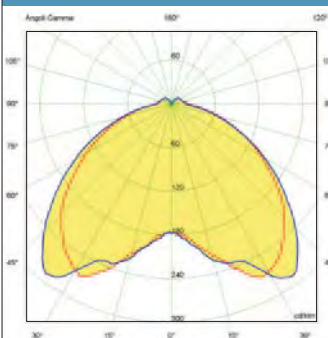

**SAVE -62%**

9x7W GX53 LED  
**63W**  
(power consumption)

Area: 10x10mt  
Height: 5mt  
**20 lux**



HQI 150W  
**165W**  
(power consumption)

Area: 10x10mt  
Height: 5mt  
**19 lux**

# EKTOR/REMO 500 GRAND SIZE

BULKHEAD  
FLOODLIGHT  
IN-GROUND  
BRICKLIGHT  
BOLLARDS  
GARDEN  
URBAN CLASSIC  
URBAN MODERN  
HIGH-BAY  
POST  
LAMPS

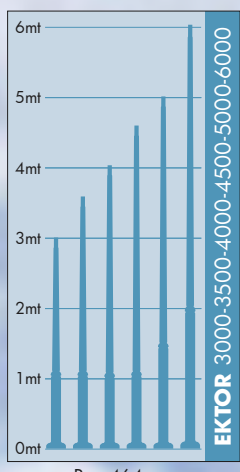
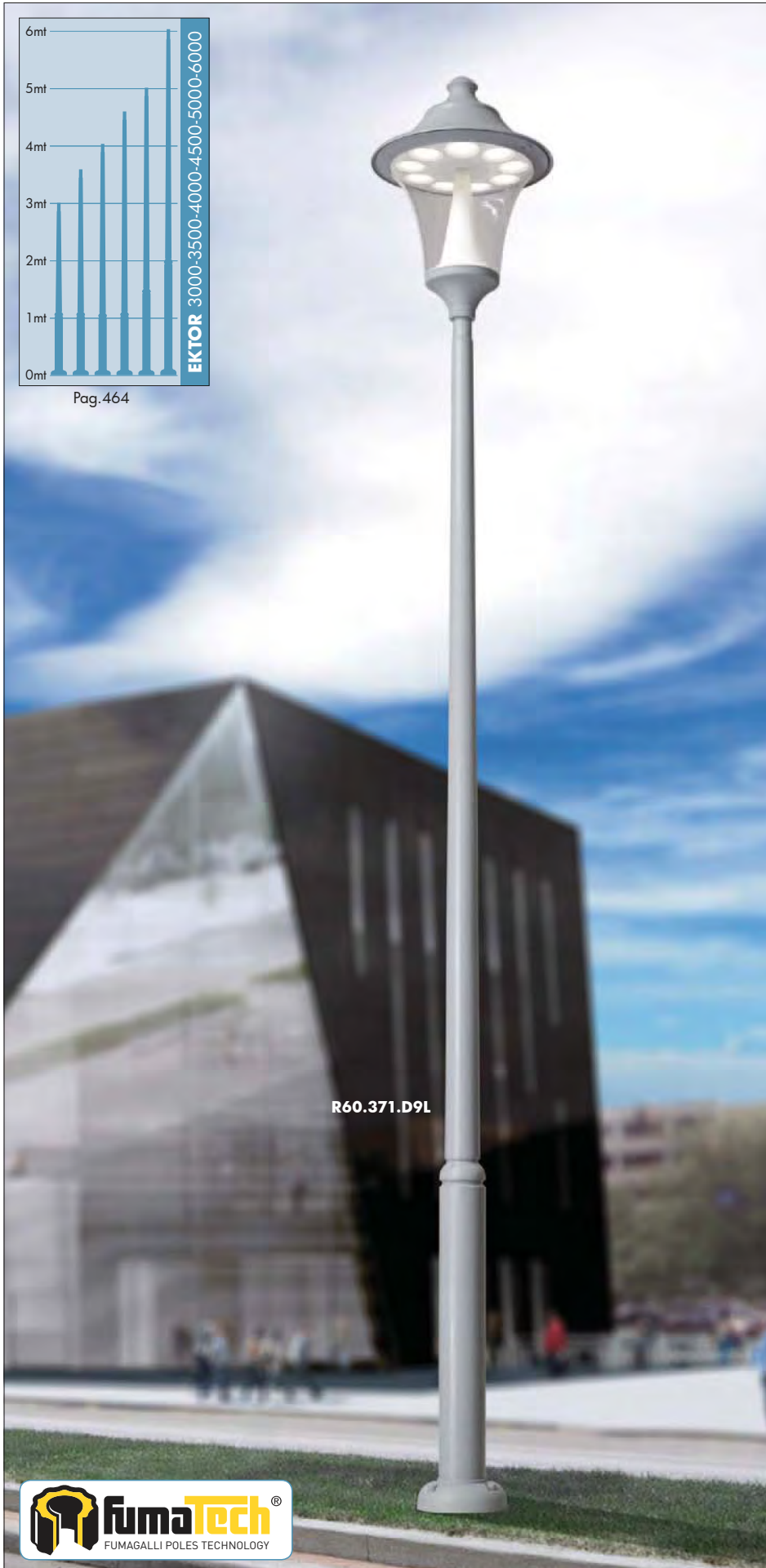

Pag. 464



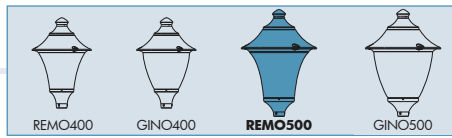

**EKTOR 6000/REMO500**  
R60.384.000

Pcs 1  
Kg 65,5  
mc 1,32

600

NEW 6m POST

6735

400

**EKTOR 5000/REMO500**  
R60.377.000

Pcs 1  
Kg 50,5  
mc 0,39

600

5735

Ø 265

<b>EKTOR 4000/REMO500</b> R60.371.000	<b>EKTOR 4500/REMO500</b> R60.374.000
Pcs 1 Kg 44,5 mc 0,33	Pcs 1 Kg 47,5 mc 0,36

600

5235  
4735

Ø 265

**REMO500**  
R60.000

Pcs 1  
Kg 8,5  
mc 0,11

600

850

Ø 60

<b>EKTOR 3000/REMO500</b> R60.364.000	<b>EKTOR 3500/REMO500</b> R60.367.000
Pcs 1 Kg 38,5 mc 0,28	Pcs 1 Kg 41,5 mc 0,31

600

4235  
3735

Ø 265

BULKHEAD

FLOODLIGHT

IN-GROUND

BRICKLIGHT

BOLLARDS

GARDEN

URBAN CLASSIC

URBAN MODERN

HIGH-BAY

POST

LAMPS



AKILLE/**REMO 500**  
GRAND SIZE

BULKHEAD  
FLOODLIGHT  
IN-GROUND  
BRICKLIGHT  
BOLLARDS  
GARDEN  
URBAN CLASSIC  
URBAN MODERN  
HIGH-BAY  
POST  
LAMPS



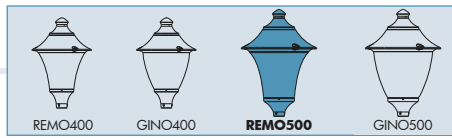

**AKILLE 5000/REMO500**  
R60.427.000

Pcs 1  
Kg 50,5  
mc 0,39

600

5735

Ø 265

<b>AKILLE 4000/REMO500</b> R60.421.000	<b>AKILLE 4500/REMO500</b> R60.424.000
Pcs 1 Kg 44,5 mc 0,33	Pcs 1 Kg 47,5 mc 0,36

600

5235

4735

Ø 265

<b>AKILLE 3000/REMO500</b> R60.414.000	<b>AKILLE 3500/REMO500</b> R60.417.000
Pcs 1 Kg 38,5 mc 0,28	Pcs 1 Kg 41,5 mc 0,31

600

4235

3735

Ø 265

**PILAR/REMO500**  
R60.253

Pcs 1  
Kg 11,5  
mc 0,14

920

1250

**NEW LOT/REMO500**  
R60.115

Pcs 1  
Kg 9,2  
mc 0,12

600

960

BULKHEAD

FLOODLIGHT

IN-GROUND

BRICKLIGHT

BOLLARDS

GARDEN

URBAN CLASSIC

URBAN MODERN

HIGH-BAY

POST

LAMPS

# GINO 500

## GRAND SIZE

Modern luminaries made of shockproof resin material, UV-rays stabilized, rust and corrosion-free. Suitable for post top or wall installation. Provided with aluminum reflector to optimize the light distribution. Base equipped with E27 lampholder prepared for ballast and louvre fixation. Insulation class II, Protection rating IP65.

*Diffusore moderno realizzato in resina antiurto, stabilizzato ai raggi UV, inattaccabile da ruggine e corrosione. Idoneo per il montaggio a palo o a parete. Provvisto di parabola riflettente in alluminio per direzionare il flusso luminoso. Base con portalampada E27 predisposta per il fissaggio dei reattori e del frangiluce. Idoneo per il montaggio a palo e a parete. Classe di isolamento II, grado di protezione IP65.*



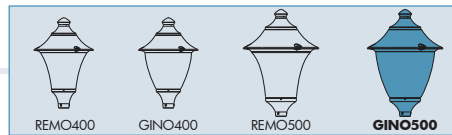

### GINO 500 E27 - E40 VERSION - COMPONENTS

IP65



**ROOF** complete with decorative pinnacle made of shockproof resin material, UV-rays stabilized, rust and corrosion-free.

**TETTO** completo di pinnacolo decorativo, realizzato in resina antiurto, stabilizzato ai raggi UV, inattaccabile da ruggine e corrosione.

Parabolic **REFLECTOR** made of anodized aluminium and fixed under the luminaries roof, designed to optimize the light efficiency performance and to allow a uniform light distribution.

**PARABOLA** riflettente realizzata in alluminio anodizzato, fissata sotto il tetto del diffusore, progettata per ottimizzare il rendimento luminoso e permettere una uniforme distribuzione della luce.

**DIFFUSER** made of UV-rays stabilized polymethylmethacrylate (PMMA), one piece only, available in clear or opal colour.

**DIFFUSORE** realizzato in polimetilmetacrilato (PMMA) stabilizzato ai raggi UV, un pezzo unico, disponibile in colore trasparente o opale.



Chrome aluminium **LOUVRE** with a laminar symmetrical optic system to direct the lighting output and to get a lower dazzle (optional).

**FRANGILUCE** in alluminio cromato con sistema ottico lamellare a ripartizione simmetrica per orientare il fascio di luce e ridurre l'abbagliamento (opzionale).

Luminaries **BASE** consisting of a support (Ø 60mm) and of a cover suitable for ballast kit fixation on its lower side and provided with E27 or E40 lampholder on its upper side. A rubber gasket assures the protection of the electrical accessories seat against external agents.

**BASE** in resina composta da un supporto e da un coperchio nella cui parte inferiore possono essere fissati i reattori e nella cui parte superiore si trova l'alloggiamento per il portalampada E27 o E40 (incluso). Una guarnizione in gomma garantisce la protezione dell'alloggiamento degli accessori elettrici dagli agenti esterni.

### GINO 500

F60.000 \*



#### Dimensions and weight

Height: 850 mm  
Diameter: 600 mm  
Weight: 8,5 Kg  
Junction to support: diameter 60 mm  
Area expose to wind pressure:  
CxS = m<sup>2</sup> 0,262

#### Moulded colours:

Black  White  Grey

#### Diffuser PMMA:

Clear  Opal

#### CHROME ALUMINIUM LOUVRE

H.FC6 open  
Upward position



### E27-E40

\* ADD. SUFFIX



Luminaries supplied with E27 or E40 lampholder and provided as an option complete with ballast kit for SON-HQI lamps.

	E27 (GLS-CFL-LED)	E27 Lampholder only	.E27
E27 WITH BALLAST KIT		SON 70W	.S70
		HQI 70W	.H70
E40 WITH BALLAST KIT		SON 100W	.S10
		HQI 100W	.H10
		SON 150W	.S15
		HQI 150W	.H15

\* ADD THESE SUFFIXES TO THE REFERENCES MENTIONED IN THE CATALOGUE

### PHOTOMETRIC DATA SAMPLE

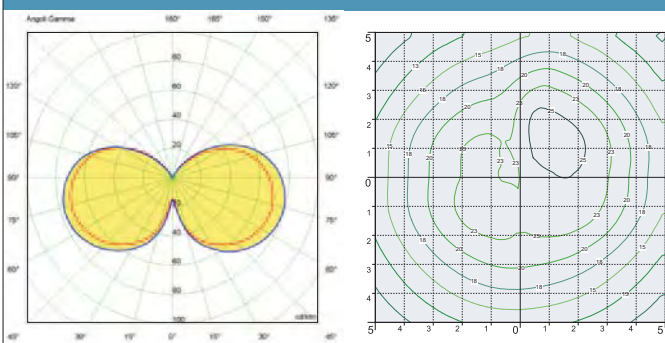

**GINO 500** clear HQI 150W.

POST height 5mt  
10x10mt area: average 19 lux

The photometric data for all the versions are available upon request or on our website.

# GINO 500 LED

## GRAND SIZE

Modern luminaries made of shockproof resin material, UV-rays stabilized, rust and corrosion-free. Suitable for post top or wall installation. Equipped with TÜV approved, long-life and efficient **GX53 LED modular system** in different wattages. Insulation class II, Protection rating IP65.

*Diffusore moderno realizzato in resina antiurto, stabilizzato ai raggi UV, inattaccabile da ruggine e corrosione. Idoneo per il montaggio a palo o a parete. Provvisto di **sistema modulare a LED GX53** approvato TÜV di lunga durata ed alta efficienza disponibile in diverse potenze. Classe di isolamento II, grado di protezione IP65.*



F60.000.D9L

- BULKHEAD
- FLOODLIGHT
- IN-GROUND
- BRICKLIGHT
- BOLLARDS
- GARDEN
- URBAN CLASSIC
- URBAN MODERN
- HIGH-BAY
- POST
- LAMPS

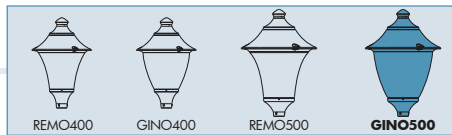

### GINO 500 LED VERSION - COMPONENTS

IP65



**ROOF** complete with decorative pinnacle made of shockproof resin material, UV-rays stabilized, rust and corrosion-free.

**TETTO** completo di pinnacolo decorativo, realizzato in resina antiurto, stabilizzata ai raggi UV, inattaccabile da ruggine e corrosione.

**DIFFUSER** made of UV-rays stabilized polymethylmethacrylate (PMMA), one piece only, available in clear or opal colour.

**DIFFUSORE** realizzato in polimetilmetacrilato (PMMA) stabilizzato ai raggi UV, disponibile in colore trasparente o opale.

Decorative connection **RING** to be fixed on the luminaries diffuser.

**ANELLO** decorative di connessione da fissare sul diffusore dell'apparecchio.

**BASE** made in shockproof resin material consisting of a support for post top installation (Ø 60mm) and of a white resin **CONE REFLECTOR**, to direct downwards the lighting output. A silicone rubber gasket assure the protection against external agents.

**BASE** dell'apparecchio realizzata in resina antiurto composta da un supporto per permettere il fissaggio dell'apparecchio a palo (Ø 60mm) e da un CONO riflettente in resina bianca per indirizzare verso il basso il flusso luminoso. Una guarnizione in gomma silconica garantisce la protezione dagli agenti esterni.

### GINO 500 LED

F60.000 \*



#### Dimensions and weight

Height: 850 mm  
Diameter: 600 mm  
Weight: 10,3 Kg  
Junction to support: diameter 60 mm  
Area expose to wind pressure:  
CxS = m<sup>2</sup> 0,262

#### Moulded colours:

Black White Grey

#### Diffuser PMMA:

Clear Opal

### GX53 LED



- **COST SAVING:** long-life and efficient LED light sources.
- **BUILT-IN DRIVER:** quick and easy lamp replacement
- **GREAT FLEXIBILITY:** GX53 standard lamp holder.
- **FUTURE-PROOFED LUMINARIES:** performances easy to upgrade to latest technology developments.
- **SUITABLE FOR OUTDOOR USE:** built-in driver fully protected against heat and humidity by silicone paste.

\*ADD. SUFFIX

Luminaries supplied with white resin CEILING provided with TÜV approved, long-life and efficient 9x GX53 LED lamps included. Each lamp can be quickly and easily replaced individually, making the luminaries maintenance very simple.



9x 7W  
**63W**

**7200 Lm**

4000 K .C9L  
3000 K .C9R

9x 10W  
**90W**

**10800 Lm**

4000 K .D9L  
3000 K .D9R

\* ADD THESE SUFFIXES TO THE REFERENCES MENTIONED IN THE CATALOGUE

### PHOTOMETRIC DATA SAMPLE - GINO 500 LED

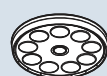
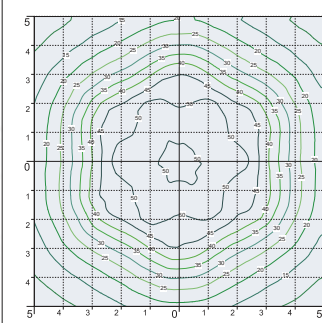
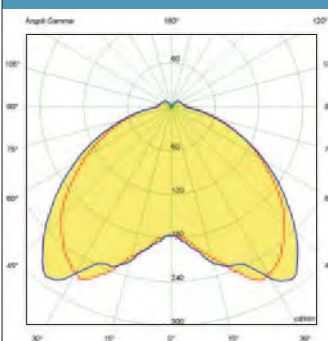

**SAVE -62%**

9x7W GX53 LED  
**63W**  
(power consumption)

Area: 10x10mt  
Height: 5mt  
**20 lux**



HQI 150W  
**165W**  
(power consumption)

Area: 10x10mt  
Height: 5mt  
**19 lux**

### GINO 500 E40

EKTOR/**GINO 500**  
GRAND SIZE

BULKHEAD  
FLOODLIGHT  
IN-GROUND  
BRICKLIGHT  
BOLLARDS  
GARDEN  
URBAN CLASSIC  
URBAN MODERN  
HIGH-BAY  
POST  
LAMPS

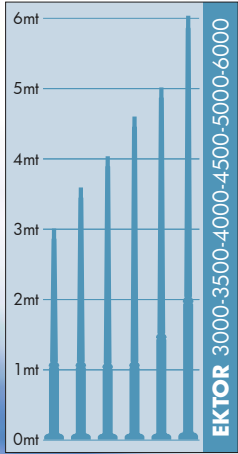

Pag. 464



F60.371.D9L



F60.374

MADE IN ITALY

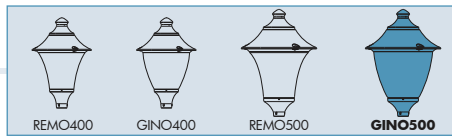

**EKTOR 6000/GINO500**  
F60.384.000

Pcs 1  
Kg 65,5  
mc 1,32

600

**NEW 6m POST**

6735

400

**EKTOR 5000/GINO500**  
F60.377.000

Pcs 1  
Kg 50,5  
mc 0,39

600

5735

Ø 265

<b>EKTOR 4000/ GINO500</b>	<b>EKTOR 4500/ GINO500</b>
F60.371.000	F60.374.000

Pcs 1  
Kg 44,5  
mc 0,33

Pcs 1  
Kg 47,5  
mc 0,36

600

5235

4735

Ø 265

**GINO500**  
F60.000

Pcs 1  
Kg 8,5  
mc 0,11

600

850

Ø 60

<b>EKTOR 3000/ GINO500</b>	<b>EKTOR 3500/ GINO500</b>
F60.364.000	F60.367.000

Pcs 1  
Kg 38,5  
mc 0,28

Pcs 1  
Kg 41,5  
mc 0,31

600

4235

3735

Ø 265

BULKHEAD

FLOODLIGHT

IN-GROUND

BRICKLIGHT

BOLLARDS

GARDEN

URBAN CLASSIC

URBAN MODERN

HIGH-BAY

POST

LAMPS



**AKILLE/GINO 500**  
GRAND SIZE

BULKHEAD  
FLOODLIGHT  
IN-GROUND  
BRICKLIGHT  
BOLLARDS  
GARDEN  
URBAN CLASSIC  
URBAN MODERN  
HIGH-BAY  
POST  
LAMPS

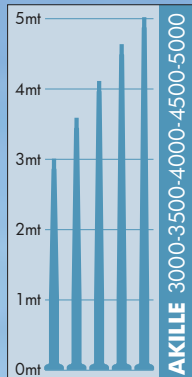

Pag.464



F60.115



F60.253

F60.421.D9L



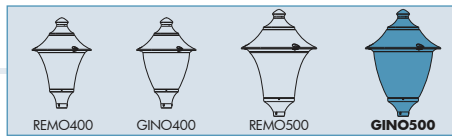

**AKILLE 5000/GINO500**  
F60.427.000

Pcs 1  
Kg 50,5  
mc 0,39

600

5735

Ø 265

AKILLE 4000/ GINO500	AKILLE 4500/ GINO500
F60.421.000	F60.424.000
Pcs 1 Kg 44,5 mc 0,33	Pcs 1 Kg 47,5 mc 0,36

600

5235  
4735

Ø 265

AKILLE 3000/ GINO500	AKILLE 3500/ GINO500
F60.414.000	F60.417.000
Pcs 1 Kg 38,5 mc 0,28	Pcs 1 Kg 41,5 mc 0,31

600

4235  
3735

Ø 265

**PILAR/GINO500**  
F60.253

Pcs 1  
Kg 11,5  
mc 0,14

920

1250

**NEW LOT/GINO500**  
F60.115

Pcs 1  
Kg 9,2  
mc 0,12

600

960

BULKHEAD

FLOODLIGHT

IN-GROUND

BRICKLIGHT

BOLLARDS

GARDEN

URBAN CLASSIC

URBAN MODERN

HIGH-BAY

POST

LAMPS

# GLOBE 400 MODERN

## LARGE SIZE

Ø 400 mm PMMA globe, complete with modern base made of shockproof resin material, UV-rays stabilized, rust and corrosion-free. Suitable for post top, hanging and wall installation. Provided with E27 lampholder and prepared for ballast and louvre fixation. Insulation class II, protection rating IP65.

*Globo Ø 400 mm in polimetilmetacrilato (PMMA) completo di base moderna realizzata in resina antiurto, stabilizzata ai raggi UV, inattaccabile da ruggine e corrosione. Idoneo per il montaggio a palo, a sospensione o a parete. Fornito con portalampada E27 e predisposto per il fissaggio dei reattori e del frangiluce. Classe di isolamento II, grado di protezione IP65.*



MADE IN  
ITALY

**GLOBE 400 MODERN E27 - COMPONENTS**

**IP65**



**400 mm GLOBE** made of UV-rays stabilized polymethylmethacrylate (PMMA), one piece only. Available in clear, opal or smoked colour.

**GLOBO Ø 400 mm** in polimetilmetacrilato (PMMA), resistente all'ingiallimento ed ai raggi UV, realizzato in un unico pezzo. Disponibile nei colori trasparente, bianco o fumé.

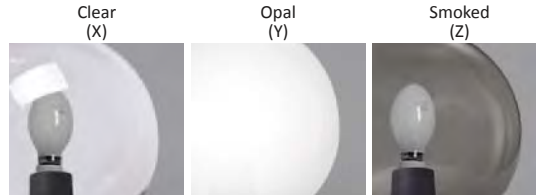

Chrome aluminium **LOUVRE** with a laminar symmetrical optic system to direct the lighting output and to get a lower dazzle (optional).

**FRANGILUCE** in alluminio cromato con sistema ottico lamellare a ripartizione simmetrica per orientare il fascio di luce e ridurre l'abbagliamento (opzionale).

Globe **BASE**, made of shockproof resin material, UV-rays stabilized, rust and corrosion-free, consisting of a support (Ø 60mm) and of a cover suitable for ballast kit fixation on its lower side and provided with E27 lampholder on its upper side. A rubber gasket assures the protection of the electrical accessories seat against external agents.

**BASE del globo**, realizzata in resina antiurto, stabilizzata ai raggi UV, inattaccabile da ruggine e corrosione. Composta da un supporto e da un coperchio nella cui parte inferiore possono essere fissati gli accessori elettrici e nella cui parte superiore si trova l'alloggiamento per il portalampada E27 (incluso). Una guarnizione in gomma garantisce la protezione dell'alloggiamento degli accessori elettrici dagli agenti esterni.

**GLOBE 400 MODERN**

G41.B40 \*



**Dimensions and weight**

Height: 530 mm  
Diameter: 400 mm  
Weight: 2,7 Kg  
Junction to support: diameter 60 mm  
Area expose to wind pressure: CxS = m<sup>2</sup> 0,122

**Moulded colours: \***

Black    White    Grey

**Diffuser PMMA:**

Clear    Opal    Smoked

\*For items shown on pages 404/405: black colour only

**CHROME ALUMINIUM LOUVRE**

H.FC1 closed  
Upward position



H.FC6 open  
Downward position



**E27**

\*ADD. SUFFIX

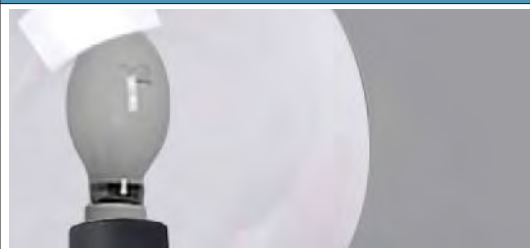

Globe complete with modern base and **E27** lampholder. Provided as an option with ballast kit for SON-HQI.

<b>E27</b> (GLS-CFL-LED)	E27 Lampholder only	.E27
<b>E27</b> WITH BALLAST KIT	SON 70W	.S70
	HQI 70W	.H70

**PHOTOMETRIC DATA SAMPLE**

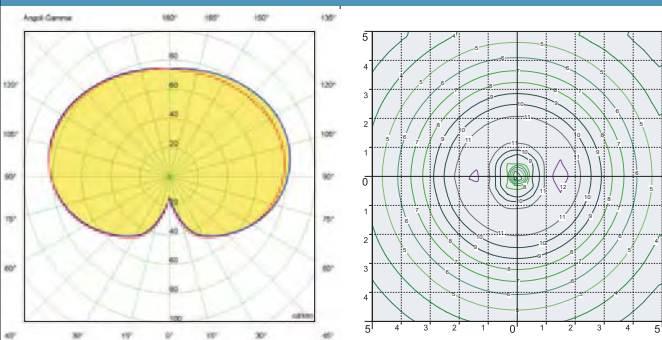

**GLOBE 400** opal HQI 70W.

POST height 3,5mt  
10x10mt area: average 7 lux

The photometric data for all the versions are available upon request or on our website.

\* ADD THESE SUFFIXES TO THE REFERENCES MENTIONED IN THE CATALOGUE

**EKTOR/GLOBE 400 MODERN**  
**LARGE SIZE**

BULKHEAD  
 FLOODLIGHT  
 IN-GROUND  
 BRICKLIGHT  
 BOLLARDS  
 GARDEN  
 URBAN CLASSIC  
 URBAN MODERN  
 HIGH-BAY  
 POST  
 LAMPS

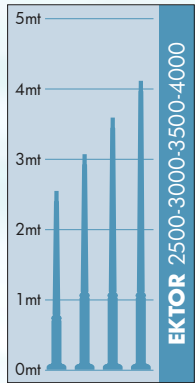

Pag.464



**MADE IN ITALY**



GLOBE 300  
MODERN



GLOBE 400  
MODERN



GLOBE 500  
MODERN

**EKTOR 3000 MIDIPILAR/GLOBE400 1L**  
**G41.364.A10**

Pcs 1  
Kg 34,8  
mc 0,26

705

3255

**EKTOR 4000 MIDIPILAR/GLOBE400 1L**  
**G41.371.A10**

Pcs 1  
Kg 40,8  
mc 0,30

705

4255

**EKTOR 4000/GLOBE400**  
**G41.371.000**

Pcs 1  
Kg 39  
mc 0,21

400

4400

**GLOBE 400**  
**G41.B40**

Pcs 2  
Kg 6  
mc 0,17

400

530

Ø 60

**EKTOR 2500 MIDIPILAR/GLOBE400 1L**  
**G41.361.A10**

Pcs 1  
Kg 28,8  
mc 0,24

705

2755

Ø 265

**EKTOR 3500 MIDIPILAR/GLOBE400 1L**  
**G41.367.A10**

Pcs 1  
Kg 37,8  
mc 0,26

705

3755

Ø 265

**EKTOR 3000 /GLOBE400**  
**G41.364.000**

Pcs 1  
Kg 33  
mc 0,17

400

3400

**EKTOR 3500/GLOBE400**  
**G41.367.000**

Pcs 1  
Kg 36  
mc 0,19

400

3900

Ø 265

**EKTOR 2500/GLOBE400**  
**G41.361.000**

Pcs 1  
Kg 23  
mc 0,15

400

2915

Ø 265

BULKHEAD

FLOODLIGHT

IN-GROUND

BRICKLIGHT

BOLLARDS

GARDEN

URBAN CLASSIC

URBAN MODERN

HIGH-BAY

POST

LAMPS

**EKTOR/GLOBE 400 MODERN**  
**LARGE SIZE**

BULKHEAD  
 FLOODLIGHT  
 IN-GROUND  
 BRICKLIGHT  
 BOLLARDS  
 GARDEN  
 URBAN CLASSIC  
 URBAN MODERN  
 HIGH-BAY  
 POST  
 LAMPS





GLOBE 300  
MODERN



GLOBE 400  
MODERN



GLOBE 500  
MODERN

EKTOR 3500 MIDIPILAR/GLOBE400 2L	EKTOR 4000 MIDIPILAR/GLOBE400 2L
G41.367.A20	G41.371.A20
Pcs 1 Kg 42,7 mc 0,47	Pcs 1 Kg 45,7 mc 0,49

EKTOR 3500 MIDIPILAR/GLOBE400 3L	EKTOR 4000 MIDIPILAR/GLOBE400 3L
G41.367.A30	G41.371.A30
Pcs 1 Kg 47,6 mc 0,55	Pcs 1 Kg 50,6 mc 0,57

EKTOR 2500 MIDIPILAR/GLOBE400 2L	EKTOR 3000 MIDIPILAR/GLOBE400 2L
G41.361.A20	G41.364.A20
Pcs 1 Kg 29,7 mc 0,42	Pcs 1 Kg 39,7 mc 0,45

EKTOR 2500 MIDIPILAR/GLOBE400 3L	EKTOR 3000 MIDIPILAR/GLOBE400 3L
G41.361.A30	G41.364.A30
Pcs 1 Kg 34,6 mc 0,51	Pcs 1 Kg 44,6 mc 0,53

BULKHEAD

FLOODLIGHT

IN-GROUND

BRICKLIGHT

BOLLARDS

GARDEN

URBAN CLASSIC

URBAN MODERN

HIGH-BAY

POST

LAMPS



# AKILLE/**GLOBE 400 MODERN** LARGE SIZE

BULKHEAD  
FLOODLIGHT  
IN-GROUND  
BRICKLIGHT  
BOLLARDS  
GARDEN  
URBAN CLASSIC  
URBAN MODERN  
HIGH-BAY  
POST  
LAMPS

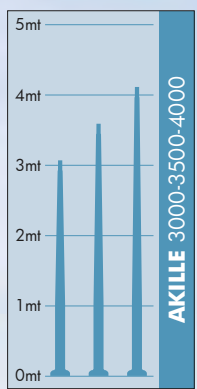

**MIDIPILAR/GLOBE 400**  
**G41.254**

Pcs 1  
Kg 3,2  
mc 0,09

**NEW LOT/GLOBE 400**  
**G41.115**

Pcs 1  
Kg 3,2  
mc 0,07

**AKILLE 4000/GLOBE400**  
**G41.421.000**

Pcs 1  
Kg 39  
mc 0,21

**AKILLE 3500/GLOBE400**  
**G41.417.000**

Pcs 1  
Kg 36  
mc 0,19

**AKILLE 3000/GLOBE400**  
**G41.414.000**

Pcs 1  
Kg 33  
mc 0,17

**AKILLE 4000 MIDIPILAR/GLOBE400 1L**  
**G41.414.A10**

Pcs 1  
Kg 34,8  
mc 0,22

**AKILLE 3500 MIDIPILAR/GLOBE400 1L**  
**G41.417.A10**

Pcs 1  
Kg 37,8  
mc 0,26

**AKILLE 3000 MIDIPILAR/GLOBE400 1L**  
**G41.414.A10**

Pcs 1  
Kg 34,8  
mc 0,22

**ILIO/GLOBE 400**  
**G41.251**

Pcs 1  
Kg 4,3  
mc 0,10

Colours available:  
black-white

**AKILLE 4000 MIDIPILAR/GLOBE400 1L**  
**G41.421.A10**

Pcs 1  
Kg 40,8  
mc 0,30

# GLOBE 500 MODERN

## GRAND SIZE

Ø 500 mm PMMA globe, complete with modern base made of shockproof resin material, UV-rays stabilized, rust and corrosion-free. Suitable for post top, hanging and wall installation. Provided with E27 lampholder and prepared for ballast and louvre fixation. Insulation class II, protection rating IP65.

*Globo Ø 500 mm in polimetilmetacrilato (PMMA) completo di base moderna realizzata in resina antiurto, stabilizzata ai raggi UV, inattaccabile da ruggine e corrosione. Idoneo per il montaggio a palo, a sospensione o a parete. Fornito con portalampada E27 e predisposto per il fissaggio dei reattori e del frangiluce. Classe di isolamento II, grado di protezione IP65.*



BULKHEAD  
FLOODLIGHT  
IN-GROUND  
BRICKLIGHT  
BOLLARDS  
GARDEN  
URBAN CLASSIC  
URBAN MODERN  
HIGH-BAY  
POST  
LAMPS

MADE IN ITALY

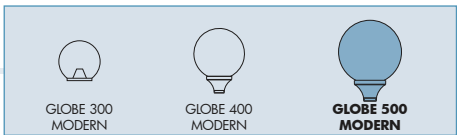

**GLOBE 500 MODERN E27 - COMPONENTS**



**IP65**



**500 mm GLOBE** made of UV-rays stabilized polymethylmethacrylate (PMMA), one piece only. Available in clear, opal or smoked colour.

**GLOBO Ø 500 mm** in polimetilmetacrilato (PMMA), resistente all'ingiallimento ed ai raggi UV, realizzato in un unico pezzo. Disponibile nei colori trasparente, bianco o fumé

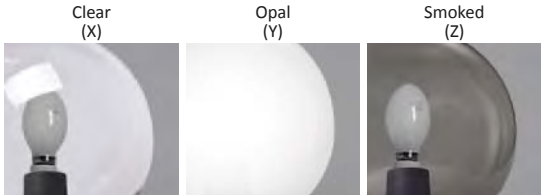

Chrome aluminium **LOUVRE** with a laminar symmetrical optic system to direct the lighting output and to get a lower dazzle (optional).

**FRANGILUCE** in alluminio cromato con sistema ottico lamellare a ripartizione simmetrica per orientare il fascio di luce e ridurre l'abbagliamento (opzionale).

Globe **BASE**, made of shockproof resin material, UV-rays stabilized, rust and corrosion-free, consisting of a support (Ø 60mm) and of a cover suitable for ballast kit fixation on its lower side and provided with E27 or E40 lampholder on its upper side. A rubber gasket assures the protection of the electrical accessories seat against external agents.

**BASE del globo**, realizzata in resina antiurto, stabilizzata ai raggi UV, inattaccabile da ruggine e corrosione. Composta da un supporto e da un coperchio nella cui parte inferiore possono essere fissati gli accessori elettrici e nella cui parte superiore si trova l'alloggiamento per il portalamпада E27 o E40 (incluso). Una guarnizione in gomma garantisce la protezione dell'alloggiamento degli accessori elettrici dagli agenti esterni.



**Dimensions and weight**  
Height: 640 mm  
Diameter: 500 mm  
Weight: 2,9 Kg  
Junction to support: diameter 60 mm  
Area expose to wind pressure:  
CxS = m<sup>2</sup> 0,181

**Moulded colours:**  
Black White Grey  
**Diffuser PMMA:**  
Clear Opal Smoked



E27-E40			
	<b>E27</b> (GLS-CFL-LED)	E27 Lampholder only	.E27
	<b>E27</b> WITH BALLAST KIT	SON 70W	.S70
HQI 70W		.H70	
Globe complete with modern base and E27 or E40 lampholder. Provided as an option with ballast kit for SON-HQI.	<b>E40</b> WITH BALLAST KIT	SON 100W	.S10
		HQI 100W	.H10

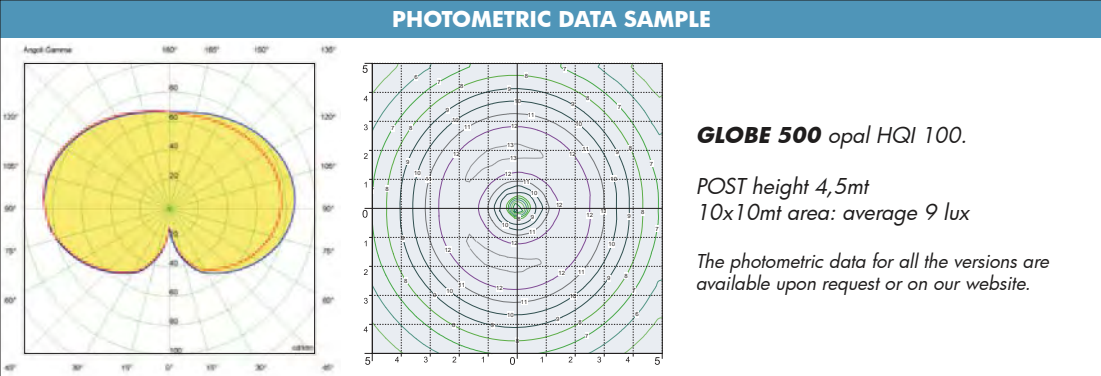

\* ADD THESE SUFFIXES TO THE REFERENCES MENTIONED IN THE CATALOGUE

**EKTOR/GLOBE 500**  
**GRAND SIZE**

BULKHEAD  
 FLOODLIGHT  
 IN-GROUND  
 BRICKLIGHT  
 BOLLARDS  
 GARDEN  
 URBAN CLASSIC  
 URBAN MODERN  
 HIGH-BAY  
 POST  
 LAMPS

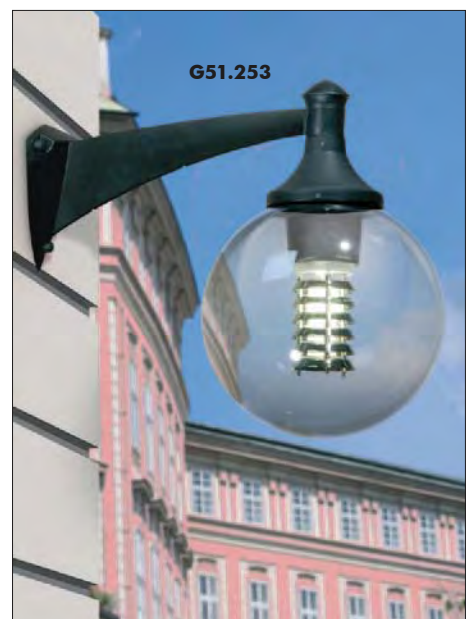
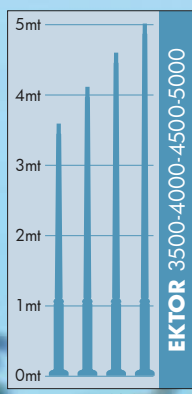

EKTOR 4500/ GLOBE500	EKTOR 5000/ GLOBE500
G51.374.000	G51.377.000
Pcs 1 Kg 43,7 mc 0,39	Pcs 1 Kg 46,7 mc 0,42

EKTOR 4500 PILAR/GLOBE500 1L	EKTOR 5000 PILAR/GLOBE500 1L
G51.374.P10	G51.377.P10
Pcs 1 Kg 48 mc 0,42	Pcs 1 Kg 51 mc 0,45

NEW LOT/GLOBE500
G51.115
Pcs 1 Kg 5,4 mc 0,15

GLOBE500
G51.B50
Pcs 2 Kg 2,9 mc 0,29

EKTOR 3500/ GLOBE500	EKTOR 4000/ GLOBE500
G51.367.000	G51.371.000
Pcs 1 Kg 37,7 mc 0,34	Pcs 1 Kg 40,7 mc 0,37

EKTOR 4000 PILAR/ GLOBE500 1L
G51.371.P10
Pcs 1 Kg 45 mc 0,39

PILAR/GLOBE500
G51.253
Pcs 1 Kg 9 mc 0,17

EKTOR 4500 PILAR/ GLOBE500 2L	EKTOR 5000 PILAR/ GLOBE500 2L
G51.374.P20	G51.377.P20
Pcs 1 Kg 54,6 mc 0,61	Pcs 1 Kg 57,6 mc 0,64

EKTOR 4000 PILAR/ GLOBE500 2L
G51.371.P20
Pcs 1 Kg 51,6 mc 0,58

# AKILLE/**GLOBE 500** GRAND SIZE

BULKHEAD  
FLOODLIGHT  
IN-GROUND  
BRICKLIGHT  
BOLLARDS  
GARDEN  
URBAN CLASSIC  
URBAN MODERN  
HIGH-BAY  
POST  
LAMPS





AKILLE 4500 PILAR/ GLOBE500 2L		AKILLE 5000 PILAR/ GLOBE500 2L	
G51.424.P20		G51.427.P20	
Pcs 1 Kg 54,6 mc 0,61			Pcs 1 Kg 57,6 mc 0,64

AKILLE 4500/ GLOBE500	AKILLE 5000/ GLOBE500		
G51.424.000	G51.427.000		
Pcs 1 Kg 43,7 mc 0,39			Pcs 1 Kg 46,7 mc 0,42

AKILLE 4500 PILAR/GLOBE500 1L	AKILLE 5000 PILAR/GLOBE500 1L		
G51.424.P10	G51.427.P10		
Pcs 1 Kg 48 mc 0,42			Pcs 1 Kg 51 mc 0,45

AKILLE 4000 PILAR/ GLOBE500 2L	
G51.421.P20	
Pcs 1 Kg 51,6 mc 0,58	

AKILLE 3500/ GLOBE500	AKILLE 4000/ GLOBE500		
G51.417.000	G51.421.000		
Pcs 1 Kg 37,7 mc 0,34			Pcs 1 Kg 40,7 mc 0,37

AKILLE 4000 PILAR/ GLOBE500 1L	
G51.421.P10	
Pcs 1 Kg 42 mc 0,37	

BULKHEAD  
FLOODLIGHT  
IN-GROUND  
BRICKLIGHT  
BOLLARDS  
GARDEN  
URBAN CLASSIC  
URBAN MODERN  
HIGH-BAY  
POST  
LAMPS



LAMPS	
POST	
HIGH-BAY	
URBAN MODERN	
URBAN CLASSIC	
GARDEN	
BOLLARDS	
BRICKLIGHT	
IN-GROUND	
FLOODLIGHT	
BULKHEAD	



# HIGH-BAY

BULKHEAD

FLOODLIGHT

IN-GROUND

BRICKLIGHT

BOLLARDS

GARDEN

URBAN CLASSIC

URBAN MODERN

POST

LAMPS

# LUIGI 400 LED

## HIGH-BAY

High-bay luminaries made of shockproof resin material, UV-rays stabilized, rust and corrosion-free. Supplied with flat diffuser granting no upward light emission and complete with hook for hanging. Equipped with TÜV approved, long-life and efficient **GX53 LED modular system** in different wattages. Insulation class II, Protection rating IP65.

*Riflettore industriale realizzato in resina antiurto, stabilizzato ai raggi UV, inattaccabile da ruggine e corrosione. Fornito con diffusore piatto per garantire assenza di emissioni di luce verso l'alto e completo di gancio di sospensione. Provvisto di sistema modulare a LED GX53 approvato TÜV di lunga durata ed alta efficienza disponibile in diverse potenze. Classe di isolamento II, grado di protezione IP65.*



L4F.128.D6L

BULKHEAD

FLOODLIGHT

IN-GROUND

BRICKLIGHT

BOLLARDS

GARDEN

URBAN CLASSIC

URBAN MODERN

HIGH-BAY

POST

LAMPS

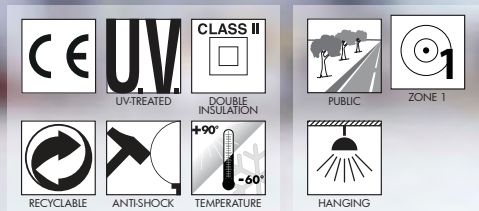



**LUIGI 400 - COMPONENTS**

**IP65**



**HANGING HOOK** made of shockproof resin material, UV-rays stabilized, rust and corrosion-free

**GANCIO** per sospensione, realizzato in resina antiurto, stabilizzata ai raggi UV, inattaccabile da ruggine e corrosione.

**ROOF** made of shockproof resin material one piece only, UV-rays stabilized, rust and corrosion-free.

**TETTO** in un unico pezzo, realizzato in resina antiurto, stabilizzata ai raggi UV, inattaccabile da ruggine e corrosione.



**DIFFUSER** with flat shape made of UV-rays stabilized polycarbonate (PC) and available in clear and opal colour.

**DIFFUSORE** con configurazione piatta realizzato in policarbonato (PC) stabilizzato ai raggi UV e disponibile in colore trasparente o opale.



Decorative connection **RING** to be fixed on the luminaries diffuser.

**ANELLO** decorative di connessione da fissare sul diffusore dell'apparecchio.



**LUIGI 400 LED**

L4F.128 \*



**Dimensions and weight**

Height: 330 mm  
Diameter: 480 mm  
Weight: 4,7 Kg  
Junction to support: diameter 60 mm  
Area expose to wind pressure:  
CxS = m<sup>2</sup> 0,1449

**Moulded colours:**

Black White Grey

**Diffuser PMMA:**

Clear Opal

**GX53 LED**



- **COST SAVING:** long-life and efficient LED light sources.
- **BUILT-IN DRIVER:** quick and easy lamp replacement
- **GREAT FLEXIBILITY:** GX53 standard lamp holder.
- **FUTURE-PROOFED LUMINARIES:** performances easy to upgrade to latest technology developments.
- **SUITABLE FOR OUTDOOR USE:** built-in driver fully protected against heat and humidity by silicone paste.

\*ADD. SUFFIX

High-bay supplied with white resin CEILING provided with TÜV approved, long-life and efficient 6x GX53 LED lamps included. Each lamp can be quickly and easily replaced individually, making the luminaries maintenance very simple.



6x 7W <b>42W</b>	<b>4800 Lm</b>	4000 K	.C6L
		3000 K	.C6R
6x 10W <b>60W</b>	<b>7200 Lm</b>	4000 K	.D6L
		3000 K	.D6R

**LED LAMPS**



More technical details about TÜV approved Fumagalli LED Lamps on page XXLAMP.

\* ADD THESE SUFFIXES TO THE REFERENCES MENTIONED IN THE CATALOGUE

**PHOTOMETRIC DATA SAMPLE**

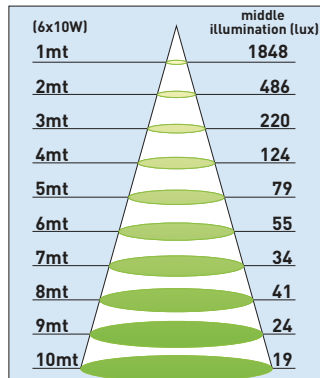
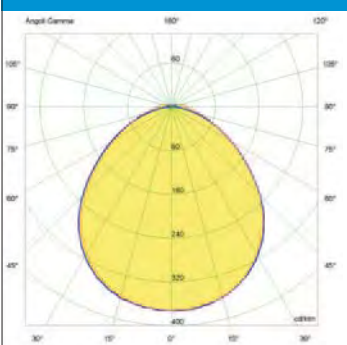

**LUIGI 400 LED**

**SAVE -50%**

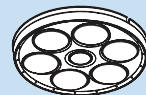

**6x7W GX53 LED 42W**

(power consumption)

**VIVI 400 E27**

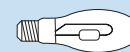

**HQI 70W 84W**

(power consumption)

**LUIGI 400 LED**  
**HIGH-BAY**



**L4F.128.D6L**



**EV4.115.D6L**



**EV4.129.D6L**

**MADE IN  
ITALY**

BULKHEAD  
FLOODLIGHT  
IN-GROUND  
BRICKLIGHT  
BOLLARDS  
GARDEN  
URBAN CLASSIC  
URBAN MODERN  
HIGH-BAY  
POST  
LAMPS

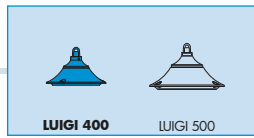

**LUIGI 400 LED**

L4F.128.C6L	<b>42W</b>	L4F.128.C6R
L4F.128.D6L	<b>60W</b>	L4F.128.D6R

4000K      6x GX53 LED LAMPS INCLUDED      3000K

Pcs 1  
Kg 3,7  
mc 0,09

**MARIO/ECOVI400 LED**

EV4.129.C6L	<b>42W</b>	EV4.129.C6R
EV4.129.D6L	<b>60W</b>	EV4.129.D6R

4000K      6x GX53 LED LAMPS INCLUDED      3000K

\* rope not included

Pcs 1  
Kg 4,5  
mc 0,07

**NEW LOT/ECOVI400 LED**

EV4.115.C6L	<b>42W</b>	EV4.115.C6R
EV4.115.D6L	<b>60W</b>	EV4.115.D6R

4000K      6x GX53 LED LAMPS INCLUDED      3000K

Pcs 1  
Kg 4,5  
mc 0,07

# LUIGI 500 LED

## HIGH-BAY

High-bay luminaries made of shockproof resin material, UV-rays stabilized, rust and corrosion-free. Supplied with flat diffuser granting no upward light emission and complete with hook for hanging. Equipped with TÜV approved, long-life and efficient **GX53 LED modular system** in different wattages. Insulation class II, Protection rating IP65.

*Riflettore industriale realizzato in resina antiurto, stabilizzato ai raggi UV, inattaccabile da ruggine e corrosione. Fornito con diffusore piatto per garantire assenza di emissioni di luce verso l'alto e completo di gancio di sospensione. Provvisto di sistema modulare a LED GX53 approvato TÜV di lunga durata ed alta efficienza disponibile in diverse potenze. Classe di isolamento II, grado di protezione IP65.*



L5F.128.D9L

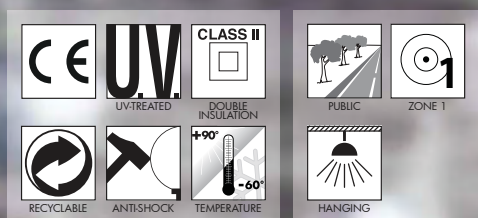



**LUIGI 500 - COMPONENTS**

**IP65**



**HANGING HOOK** made of shockproof resin material, UV-rays stabilized, rust and corrosion-free

**GANCIO** per sospensione, realizzato in resina antiurto, stabilizzata ai raggi UV, inattaccabile da ruggine e corrosione.

**ROOF** made of shockproof resin material one piece only, UV-rays stabilized, rust and corrosion-free.

**TETTO** in un unico pezzo, realizzato in resina antiurto, stabilizzata ai raggi UV, inattaccabile da ruggine e corrosione.

**DIFFUSER** with flat shape made of UV-rays stabilized polycarbonate (PC) and available in clear and opal colour.

**DIFFUSORE** con configurazione piatta realizzato in policarbonato (PC) stabilizzato ai raggi UV e disponibile in colore trasparente o opale.

Decorative connection **RING** to be fixed on the luminaries diffuser.

**ANELLO** decorative di connessione da fissare sul diffusore dell'apparecchio.



**LUIGI**

L5F.128 \*



**Dimensions and weight**

Height: 380 mm  
Diameter: 600 mm  
Weight: 6,4 Kg  
Junction to support: diameter 60 mm  
Area expose to wind pressure: CxS = m<sup>2</sup> 0,0982

**Moulded colours:**

Black White Grey

**Diffuser PC (UV treated):**

Clear Opal

**GX53 LED**



- **COST SAVING:** long-life and efficient LED light sources.
- **BUILT-IN DRIVER:** quick and easy lamp replacement
- **GREAT FLEXIBILITY:** GX53 standard lamp holder.
- **FUTURE-PROOFED LUMINARIES:** performances easy to upgrade to latest technology developments.
- **SUITABLE FOR OUTDOOR USE:** built-in driver fully protected against heat and humidity by silicone paste.

\*ADD. SUFFIX

High-bay supplied with white resin CEILING provided with TÜV approved, long-life and efficient 9x GX53 LED lamps included. Each lamp can be quickly and easily replaced individually, making the luminaries maintenance very simple.



9x 7W <b>63W</b>	<b>7200 Lm</b>	4000 K	.C9L
		3000 K	.C9R
9x 10W <b>90W</b>	<b>10800 Lm</b>	4000 K	.D9L
		3000 K	.D9R

**LED LAMPS**



More technical details about TÜV approved Fumagalli LED Lamps on page XXLAMP.

\* ADD THESE SUFFIXES TO THE REFERENCES MENTIONED IN THE CATALOGUE

**PHOTOMETRIC DATA SAMPLE**

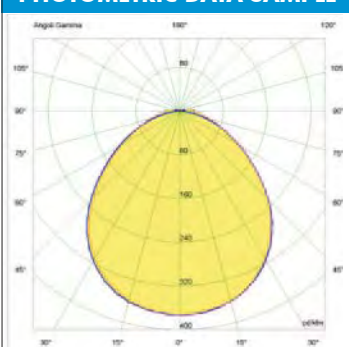

(9x10W)	middle illumination (lux)
1mt	2802
2mt	752
3mt	342
4mt	192
5mt	124
6mt	85
7mt	62
8mt	48
9mt	38
10mt	31

**LUIGI 500 LED**

**SAVE -45%**

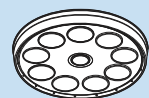

**9x10W GX53 LED 90W**

(power consumption)

**VIVI 500 E27**

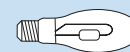

**HQI 150W 165W**

(power consumption)



**LUIGI 500 LED**  
HIGH-BAY

BULKHEAD

FLOODLIGHT

IN-GROUND

BRICKLIGHT

BOLLARDS

GARDEN

URBAN CLASSIC

URBAN MODERN

HIGH-BAY

POST

LAMPS



L5F.128.D9L



EV6.129.D9L

MADE IN  
ITALY



**HIGH-BAY LUIGI 500 LED**

L5F.128.C9L	<b>63W</b>	L5F.128.C9R
L5F.128.D9L	<b>90W</b>	L5F.128.D9R

4000K      9x GX53 LED LAMPS INCLUDED      3000K

Pcs 1  
Kg 3,7  
mc 0,09

**MARIO/ECOVI500 LED**

EV6.129.C9L	<b>63W</b>	EV6.129.C9R
EV6.129.D9L	<b>90W</b>	EV6.129.D9R

4000K      9x GX53 LED LAMPS INCLUDED      3000K

\*rope not included

Pcs 1  
Kg 4,9  
mc 0,09

**NEW LOT/ECOVI500 LED**

EV6.115.C9L	<b>63W</b>	EV6.115.C9R
EV6.115.D9L	<b>90W</b>	EV6.115.D9R

4000K      9x GX53 LED LAMPS INCLUDED      3000K

Pcs 1  
Kg 4,9  
mc 0,09

	LAMPS
	POST
	HIGH-BAY
	URBAN MODERN
	URBAN CLASSIC
	GARDEN
	BOLLARDS
	BRICKLIGHT
	IN-GROUND
	FLOODLIGHT
	BULKHEAD

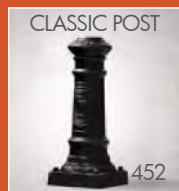

# POST

BULKHEAD

FLOODLIGHT

IN-GROUND

BRICKLIGHT

BOLLARDS

GARDEN

URBAN CLASSIC

URBAN MODERN

HIGH-BAY

LAMPS

## CLASSIC POSTS

### OUR COLLECTION

CLASSIC lighting poles of a single piece without joints, made of shockproof composite material (steel-expanse-resin), UV-rays stabilized, rust and corrosion-free. Moulded colours in paste, no maintenance or painting required. Insulation class II. Available in many design options and different sizes from 0,7mt up to 5mt high. Provided with suitable cage for ground fixation.

*Pali in stile CLASSICO fabbricati in un unico pezzo senza giunzioni. Realizzati in materiale composito antiurto (ferro-resina-poliuretano), stabilizzato ai raggi UV, inattaccabile da ruggine e corrosione. Colore stampato in pasta, non necessita di verniciatura. Classe di isolamento II. Disponibili in numerose varianti decorative e in diverse altezze da mt. 0,7 a mt. 5. Provvisti di gabbia per il fissaggio a terra.*



MADE IN  
ITALY

**METAL POST COVERED BY RESIN**

Fumagalli **created** and developed a unique post technology, registered as **FUMATECH**. Fumatech technology grants to our lamps the same strength features of a metal post, combined with all the advantages in terms of rust and corrosion resistance that only a resin material can offer.

L'azienda Fumagalli ha **creato** e sviluppato un'esclusiva tecnologia per la fabbricazione dei pali, registrata come **FUMATECH**. La tecnologia FUMATECH assicura alle nostre lampade le medesime caratteristiche di solidità di un palo in metallo, con tutti i vantaggi in termini di resistenza alla ruggine e alla corrosione che solo la resina può offrire.



more details  
at Pag. 16



**INNER METAL POLE STRUCTURE**

Structural metal pole hot deep galvanized inside and outside by zinc bath immersion.

*Palo strutturale in metallo galvanizzato a caldo sia all'interno che all'esterno tramite immersione in bagno di zinco.*

**EXPANSE**

High Density rigid polyurethane provides lightweight and durable cohesion between the inner metal post and the outer resin cover.

*Il poliuretano ad alta densità. Rigido ma molto leggero, garantisce una coesione duratura nel tempo tra il palo interno in metallo e la copertura esterna in resina.*

**OUTER RESIN COVER**

Outer coating of a single piece without joints made of shockproof resin material:  
- Rust and corrosion-free  
- Paste molded colors, UV stabilized  
- Self-extinguishing on fire

*Rivestimento esterno in un unico pezzo fabbricato in resina antiurto:  
- Inattaccabile da ruggine e corrosione  
- Colori in pasta stabilizzati ai raggi UV  
- Autoestinguente al fuoco*

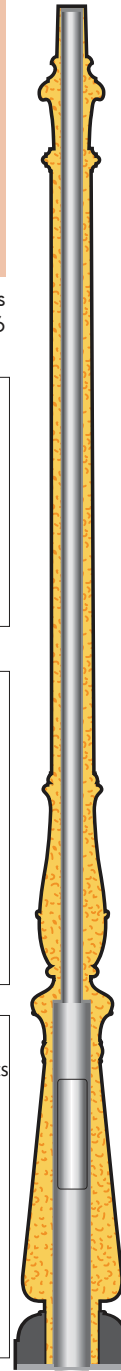

**ANTI CORROSION**



**NO MAINTENANCE**



**UV-RAYS STABILIZED**



**SAFE**



**UNAFFECTED BY CHEMICAL FERTILIZES**

**FULLY MODULAR**



All the connection hubs of FUMAGALLI poles and lanterns have a diameter of 60 mm; this unique feature allows many different possible combinations of complete lamps with the same components, for a big stock flexibility.

**POST COLOURS**

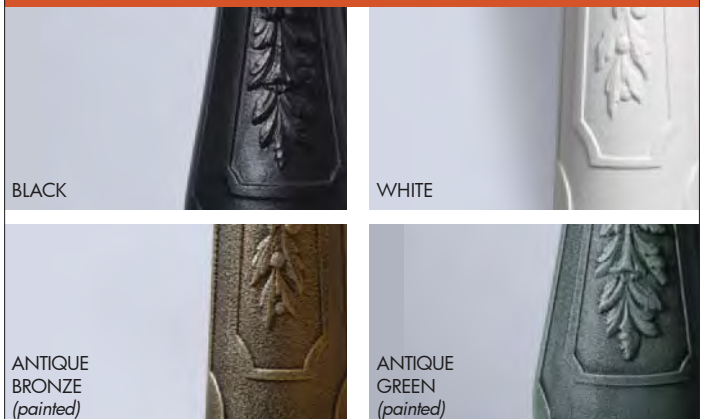

# CLASSIC POSTS

## INSPECTION DOORS

BULKHEAD  
FLOODLIGHT  
IN-GROUND  
BRICKLIGHT  
BOLLARDS  
GARDEN  
URBAN CLASSIC  
URBAN MODERN  
HIGH-BAY  
POST  
LAMPS

**for KARMEI posts**

Inspection door opening:  
**340 x 80 mm**

**The inspection door can be personalized with your own logo (available only for KARMEI posts)**

*La porta di ispezione può essere personalizzata con il vostro LOGO (disponibile solo per i pali KARMEI)*

**for NEBO TABOR HOREB posts**

Inspection door opening:  
**320 x 60 mm**

**Duble Insulation**  
**4 x 16 mm<sup>2</sup>**  
**3 - WAY**

**CLASS II** **IP44**

**Fuse holder lfo electric cc.10**

**for GIONA posts**

Inspection door opening:  
**185 x 80 mm**

**VERY EASY MAINTENANCE: IT'S ENOUGH TO CLEAN THE POST WITH SOME OIL TO KEEP IT AS BRIGHT AS NEW.**

**CLASSIC POST - FOUNDATION SYSTEM**



**SUGGESTED SIZES FOR CONCRETE FOUNDATION**

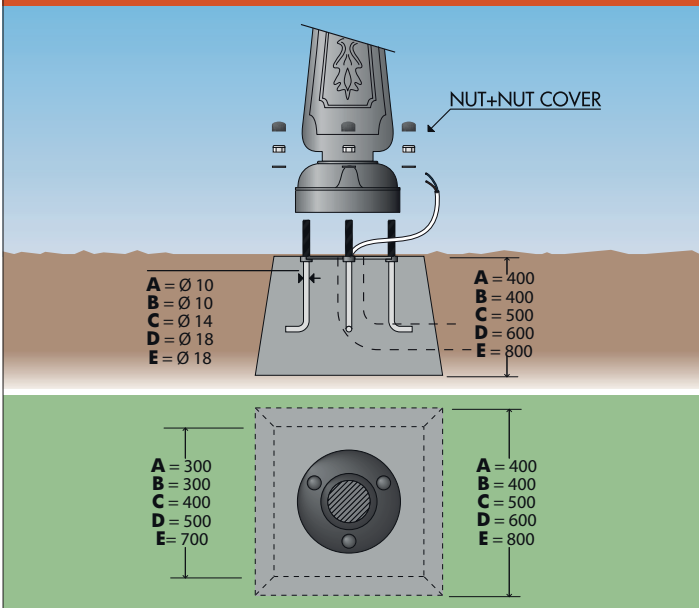

All Fumagalli poles are supplied with suitable cages for fixing into concrete foundations. The size of the cages and the size of the concrete foundation varies according to the high of the post.

*Tutti i pali Fumagalli sono forniti complete di gabbie per il fissaggio a terra. Le dimensioni della gabbia e del plinto di cemento variano a secondo dell'altezza del palo.*

The fixation system with two triangles allows the anchor bolts to be cemented perpendicularly to the ground. The second triangle has to be removed before installing the pole.

*Il sistema di fissaggio con due triangoli assicura che i tiranti vengano affogati nel cemento in maniera perfettamente perpendicolare rispetto al terreno. Il secondo triangolo deve essere rimosso prima di procedere al fissaggio del palo.*

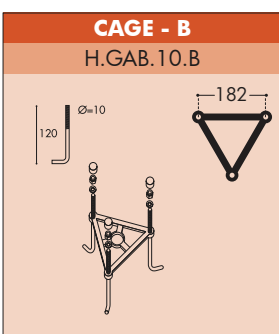
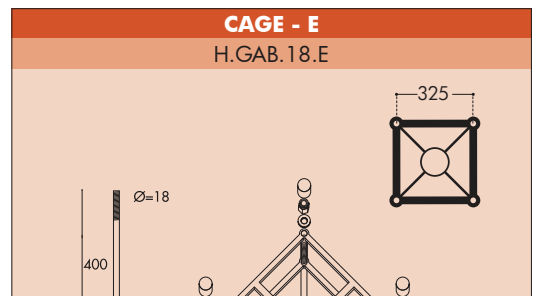
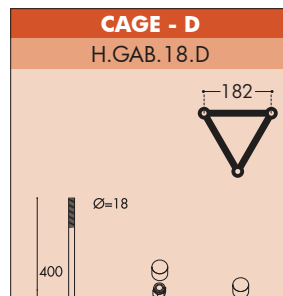
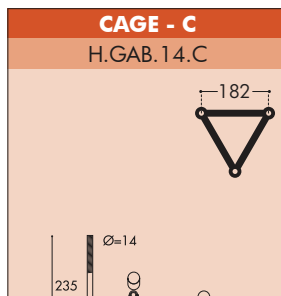
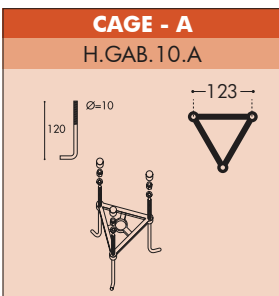



# CLASSIC POSTS

## CLASSIC POST COLLECTION

Each post is supplied with the suitable cage or screws for fixation.

Colours available for the CLASSIC range are the following:

Moulded colours: **Black - White**

Painted Colours: **Antique Green - Antique Bronze**

WITHOUT DOOR  
WITH DOOR  
WITH DOOR AND BOX

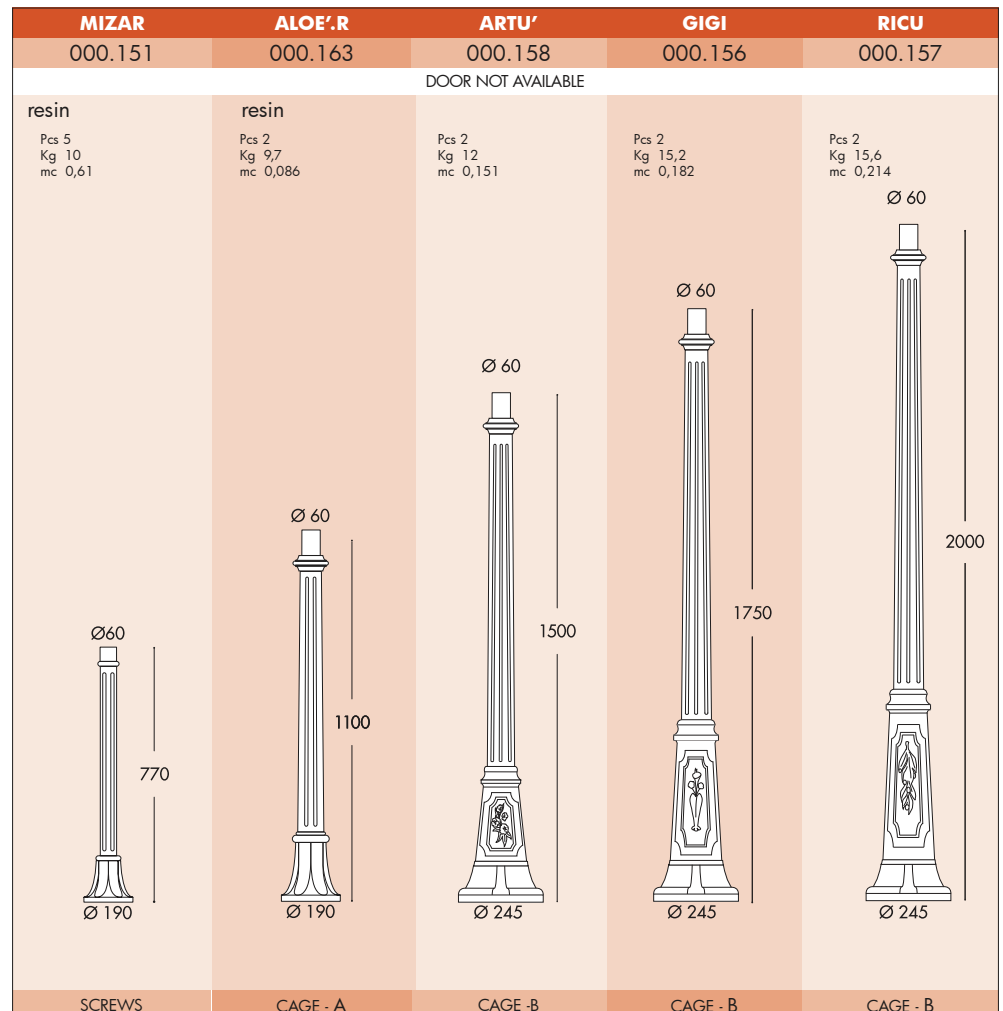
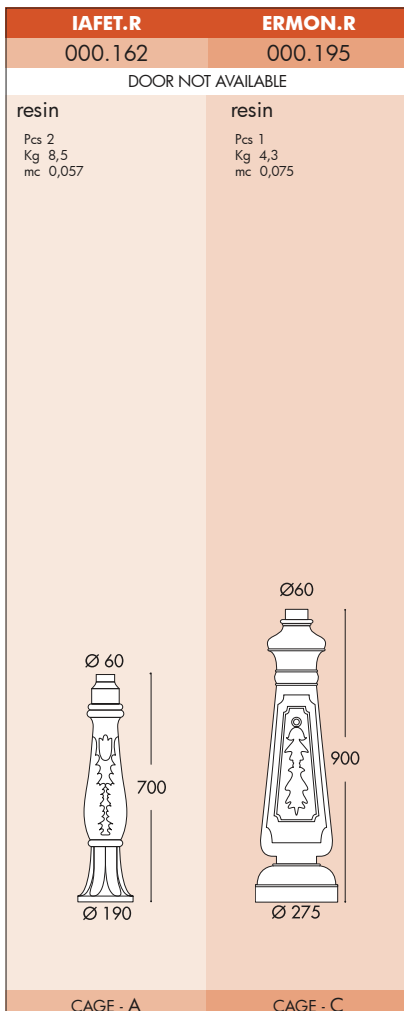
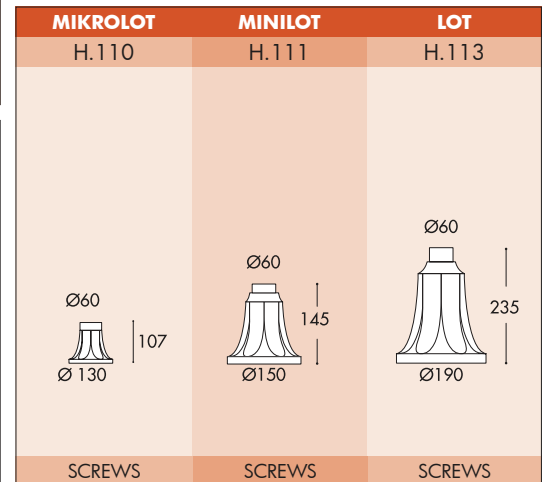
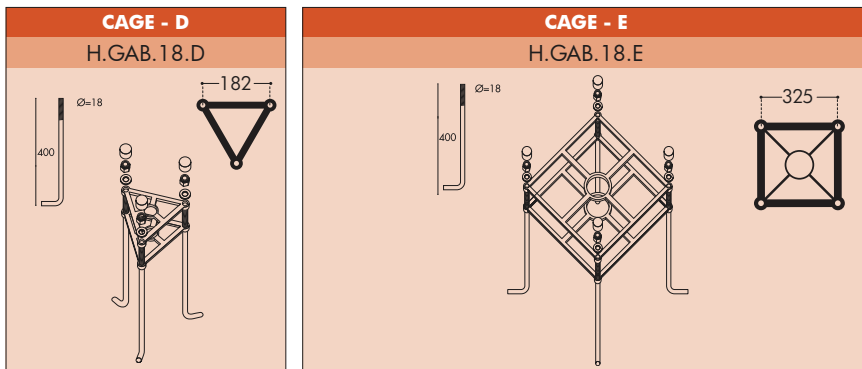
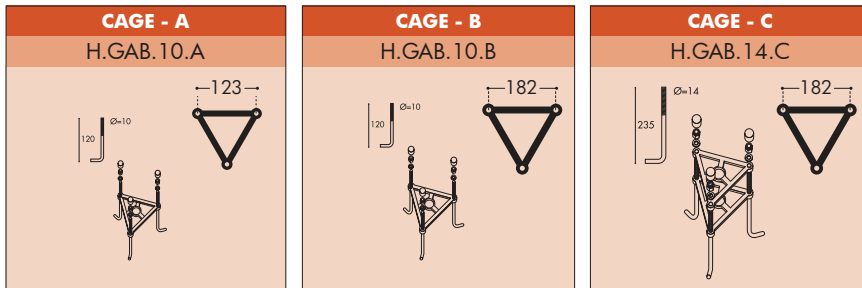

NEBO			TABOR			HOREB			KARMEL 3000			KARMEL 3500			KARMEL 4000			GIONA 4000			GIONA 4500			GIONA 5000		
000.201	000.204	000.207	000.201	000.204	000.207	000.201	000.204	000.207	000.231	000.234	000.237	000.231	000.234	000.237	000.231	000.234	000.237	000.221	000.224	000.227	000.221	000.224	000.227	000.221	000.224	000.227
000.202	000.205	000.208	000.202	000.205	000.208	000.202	000.205	000.208	000.232	000.235	000.238	000.232	000.235	000.238	000.232	000.235	000.238	000.222	000.225	000.228	000.222	000.225	000.228	000.222	000.225	000.228
000.203	000.206	000.209	000.203	000.206	000.209	000.203	000.206	000.209	000.233	000.236	000.239	000.233	000.236	000.239	000.233	000.236	000.239	000.223	000.226	000.229	000.223	000.226	000.229	000.223	000.226	000.229
DOOR IS OPTIONAL									DOOR IS OPTIONAL									DOOR IS OPTIONAL								
Pcs 1 Kg 22 mc 0,135	Pcs 1 Kg 25,5 mc 0,164	Pcs 1 Kg 29 mc 0,190	Pcs 1 Kg 23,5 mc 0,167	Pcs 1 Kg 25 mc 0,193	Pcs 1 Kg 28,5 mc 0,220	Pcs 1 Kg 51 mc 0,744	Pcs 1 Kg 54 mc 0,871	Pcs 1 Kg 57 mc 0,968																		
Ø 275	Ø 275	Ø 275	Ø 275	Ø 275	Ø 275	Ø 275	Ø 275	Ø 275	Ø 275	Ø 275	Ø 275	Ø 275	Ø 275	Ø 275	Ø 275	Ø 275	Ø 275	Ø 275	Ø 275	Ø 275	Ø 275	Ø 275	Ø 275	Ø 275	Ø 275	Ø 275
CAGE - C	CAGE - C	CAGE - C	CAGE - C	CAGE - C	CAGE - C	CAGE - C	CAGE - C	CAGE - D	CAGE - E	CAGE - E	CAGE - E	CAGE - E	CAGE - E	CAGE - E	CAGE - E	CAGE - E	CAGE - E	CAGE - E	CAGE - E	CAGE - E	CAGE - E	CAGE - E	CAGE - E	CAGE - E	CAGE - E	CAGE - E

BULKHEAD  
FLOODLIGHT  
IN-GROUND  
BRICKLIGHT  
BOLLARDS  
GARDEN  
URBAN CLASSIC  
URBAN MODERN  
HIGH-BAY  
POST  
LAMPS

# CLASSIC POSTS

## CLASSIC POST TOP SYSTEMS



Ø 60mm

### FULLY MODULAR

All the connection hubs of FUMAGALLI poles and lanterns have a diameter of 60 mm; this unique feature allows many different possible combinations of complete lamps with the same components, for a big stock flexibility.

*I terminali di connessione dei pali e delle lanterne FUMAGALLI hanno sempre un diametro di 60 mm; questa caratteristica unica permette svariate combinazioni di lampade complete con i medesimi componenti per una grande flessibilità di magazzino.*

### BISSO SYSTEM

BISSO SYSTEM 2L 000.000.S20	BISSO SYSTEM 2 + 1 000.000.S21	BISSO SYSTEM 3L 000.000.S30	BISSO SYSTEM 3 + 1 000.000.S31

### OFIR SYSTEM



















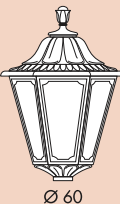





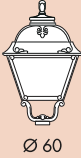

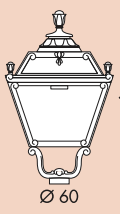

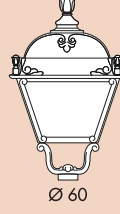



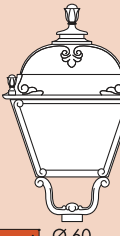



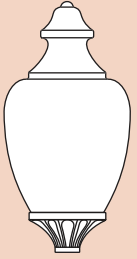

OFIR SYSTEM 2L 000.000.R20	OFIR SYSTEM 2 + 1 000.000.R21	OFIR SYSTEM 3L 000.000.R30	OFIR SYSTEM 3 + 1 000.000.R31

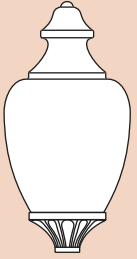
### ADAM SYSTEM

ADAM SYSTEM 2L 000.000.M20	ADAM SYSTEM 2 + 1 000.000.M21	ADAM SYSTEM 3L 000.000.M30	ADAM SYSTEM 3 + 1 000.000.M31

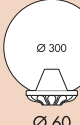
### ARON SYSTEM

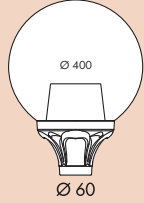
ARON SYSTEM 1L 000.000.N10	ARON SYSTEM 2L 000.000.N20	ARON SYSTEM 4L 000.000.N40

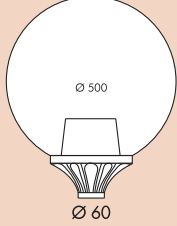
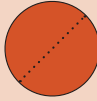
	SMALL SIZE	MEDIUM SIZE	LARGE SIZE	GRAND SIZE				
<b>HEXAGONAL LANTERNS</b>	<b>ANNA</b> E22.000  220 Ø 60  220	<b>SABA</b> K22.000  220 Ø 60  220	<b>RUT</b> E26.000  260 Ø 60  260	<b>SALEM</b> K26.000  260 Ø 60  260	<b>NOEMI</b> E35.000  350 Ø 60  350	<b>SILOE</b> K35.000  350 Ø 60  350		
	<b>SQUARE LANTERNS</b>		<b>GOLIA</b> Q23.000  230 Ø 60  230	<b>CEFA</b> U23.000  230 Ø 60  230	<b>TOBIA</b> Q33.000  330 Ø 60 * FLAT DIFFUSER  330	<b>SIMON</b> U33.000  330 Ø 60 * FLAT DIFFUSER  330	<b>ELIA</b> Q43.000  430 Ø 60 * FLAT DIFFUSER  430	<b>PIETRO</b> U43.000  430 Ø 60 * FLAT DIFFUSER  430
<b>HALF LANTERNS</b>		<b>IESSE</b> M22.000  130 350  220			<b>DARIA</b> M28.000  143 515  280	<b>AMPHORAE</b>  690  Ø400	<b>CANA 500</b> C50.B50  690  Ø400	
	<b>GLOBES</b>	<b>GLOBE 250 CLASSIC</b> G25.B25  260 Ø 250 Ø 60  Ø250	<b>GLOBE 300 CLASSIC</b> G30.B30  310 Ø 300 Ø 60  Ø300	<b>GLOBE 400 CLASSIC</b> G40.B40  530 Ø 400 Ø 60  Ø400	<b>GLOBE 500 CLASSIC</b> G50.B50  630 Ø 500 Ø 60  Ø500			

BULKHEAD  
FLOODLIGHT  
IN-GROUND  
BRICKLIGHT  
BOLLARDS  
GARDEN  
URBAN CLASSIC  
URBAN MODERN  
HIGH-BAY  
POST  
LAMPS

## MODERN POSTS

### OUR COLLECTION

MODERN lighting poles of a single piece without joints, made of shockproof composite material (steel-expanse-resin), UV-rays stabilized, rust and corrosion-free. Insulation class II. Moulded colours in paste, no maintenance or painting required. Insulation class II. Available in many design options and different sizes from 0,7mt up to 6mt high. Provided with suitable cage for ground fixation.

*Pali in stile MODERNO fabbricati in un unico pezzo senza giunzioni. Realizzati in materiale composito antiurto (ferro-resina-poliuretano), stabilizzato ai raggi UV, inattaccabile da ruggine e corrosione. Colore stampato in pasta, non necessita di verniciatura. Classe di isolamento II. Disponibili in numerose varianti decorative e in diverse altezze da mt. 0,7 a mt. 6. Provvisti di gabbia per il fissaggio a terra.*



MADE IN  
ITALY

**METAL POST COVERED BY RESIN**

Fumagalli **created** and developed a unique post technology, registered as **FUMATECH**. Fumatech technology grants to our lamps the same strength features of a metal post, combined with all the advantages in terms of rust and corrosion resistance that only a resin material can offer.

L'azienda Fumagalli ha **creato** e sviluppato un'esclusiva tecnologia per la fabbricazione dei pali, registrata come **FUMATECH**. La tecnologia FUMATECH assicura alle nostre lampade le medesime caratteristiche di solidità di un palo in metallo, con tutti i vantaggi in termini di resistenza alla ruggine e alla corrosione che solo la resina può offrire.



more details  
at Pag. 16



**INNER METAL POLE STRUCTURE**

Structural metal pole hot deep galvanized inside and outside by zinc bath immersion.

*Palo strutturale in metallo galvanizzato a caldo sia all'interno che all'esterno tramite immersione in bagno di zinco.*

**EXPANSE**

High Density rigid polyurethane provides lightweight and durable cohesion between the inner metal post and the outer resin cover.

*Il poliuretano ad alta densità. Rigido ma molto leggero, garantisce una coesione duratura nel tempo tra il palo interno in metallo e la copertura esterna in resina.*

**OUTER RESIN COVER**

Outer coating of a single piece without joints made of shockproof resin material:

- Rust and corrosion-free
- Paste molded colors, UV stabilized
- Self-extinguishing on fire

*Rivestimento esterno in un unico pezzo fabbricato in resina antiurto:*

- Inattaccabile da ruggine e corrosione
- Colori in pasta stabilizzati ai raggi UV
- Autoestinguento al fuoco

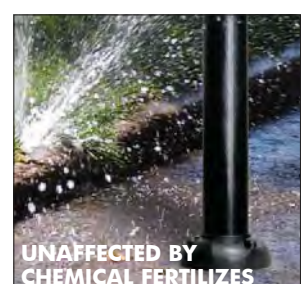
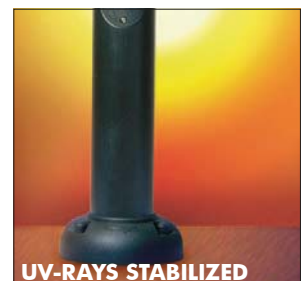
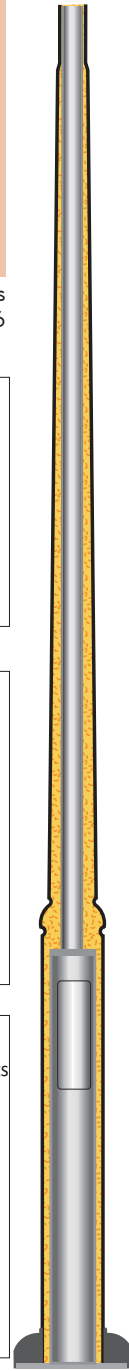

**MODULAR SYSTEM**



All the connection hubs of FUMAGALLI poles and lanterns have a diameter of 60 mm; this unique feature allows many different possible combinations of complete lamps with the same components, for a big stock flexibility.

**POST COLOURS**



# MODERN POSTS

## INSPECTION DOORS

BULKHEAD  
FLOODLIGHT  
IN-GROUND  
BRICKLIGHT  
BOLLARDS  
GARDEN  
URBAN CLASSIC  
URBAN MODERN  
HIGH-BAY  
POST  
LAMPS

**for EKTOR and AKILLE posts**



Inspection door opening:  
**340 x 80 mm**

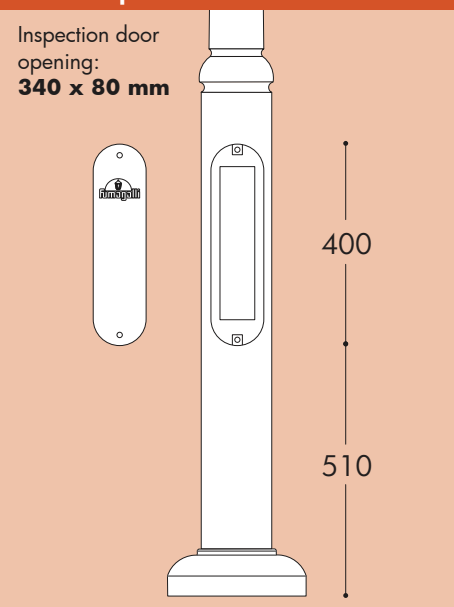



The inspection door can be personalized with your own logo (available for EKTOR and AKILLE posts)

*La porta di ispezione può essere personalizzata con il vostro LOGO (disponibile per i pali EKTOR e AKILLE)*

**for EKTOR2500 post**

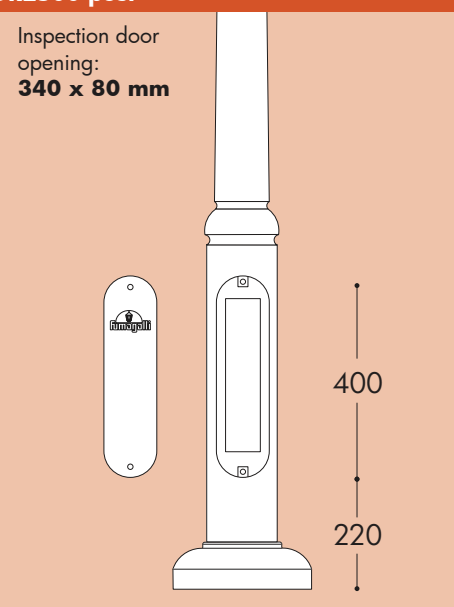

Inspection door opening:  
**340 x 80 mm**



**Duble Insulation**  
4 x 16 mm<sup>2</sup>  
3 - WAY

**CLASS II** **IP44**

Fuse holder Ifo electric cc.10

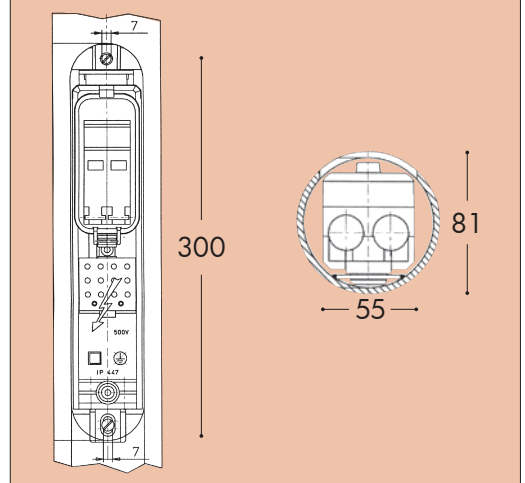

**MODERN POST - FOUNDATION SYSTEM**



**SUGGESTED SIZES FOR CONCRETE FOUNDATIONS**

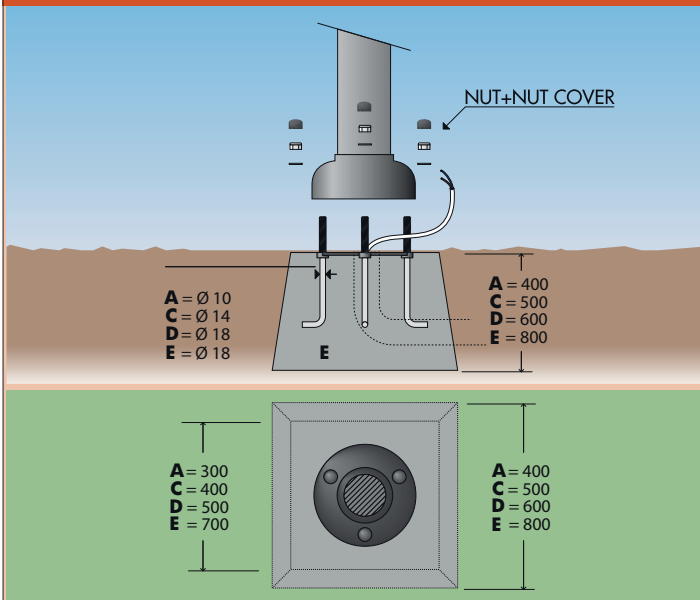

All Fumagalli poles are supplied with suitable cages for fixing into concrete foundations. The size of the cages and the size of the concrete foundation varies according to the high of the post.

*Tutti i pali Fumagalli sono forniti complete di gabbie per il fissaggio a terra. Le dimensioni della gabbia e del plinto di cemento variano a secondo dell'altezza del palo.*

The fixation system with two triangles allows the anchor bolts to be cemented perpendicularly to the ground. The second triangle has to be removed before installing the pole.

*Il sistema di fissaggio con due triangoli assicura che i tiranti vengano affogati nel cemento in maniera perfettamente perpendicolare rispetto al terreno. Il secondo triangolo deve essere rimosso prima di procedere al fissaggio del palo.*

**CAGE - A**  
H.GAB. 10.A

**CAGE - C**  
H.GAB. 14.C

**CAGE - D**  
H.GAB. 18.D

**CAGE - E**  
H.GAB. 18.E



# MODERN POSTS

## MODERN POST COLLECTION

Each post is supplied with the suitable cage or screws for fixation.

Moulded Colours available for the MODERN range are the following:

For ARGO, FEBO and ENEA posts: **Black - White**

For EKTOR, AKILLE posts: **Black - White - Grey**

WITHOUT DOOR	000.414	000.417	000.421
WITH DOOR	000.415	000.418	000.422
WITH DOOR AND BOX	000.416	000.419	000.423

AKILLE 3000	AKILLE 3500	AKILLE 4000
000.414	000.417	000.421
000.415	000.418	000.422
000.416	000.419	000.423

DOOR IS OPTIONAL

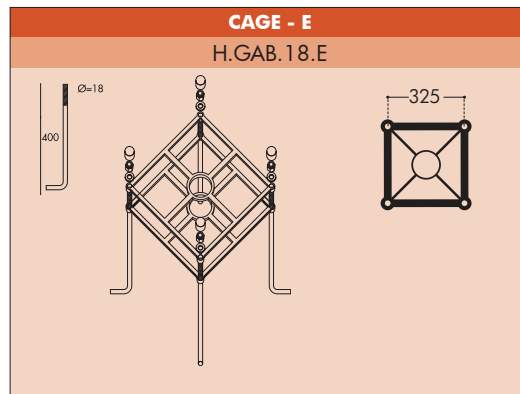
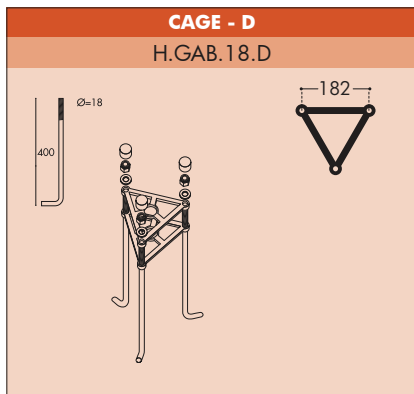
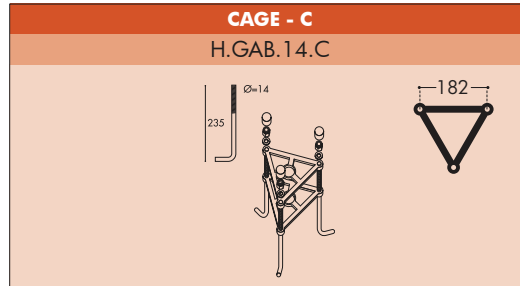
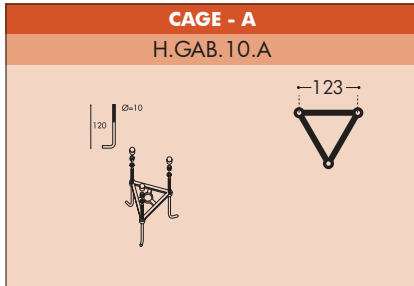

ARGO	FEBO 500	FEBO 1000	FEBO 1500
000.241	000.261	000.262	000.263

DOOR NOT AVAILABLE

resin	resin	resin	
Pcs 10 Kg 5,0 mc 0,060	Pcs 4 Kg 6,7 mc 0,057	Pcs 4 Kg 9,3 mc 0,086	Pcs 4 Kg 19,6 mc 0,118

ENEA 2000	ENEA 2400	ENEA 2800
000.264	000.265	000.266

DOOR NOT AVAILABLE

Pcs 2 Kg 17,3 mc 0,111	Pcs 2 Kg 21,2 mc 0,132	Pcs 2 Kg 25,3 mc 0,151

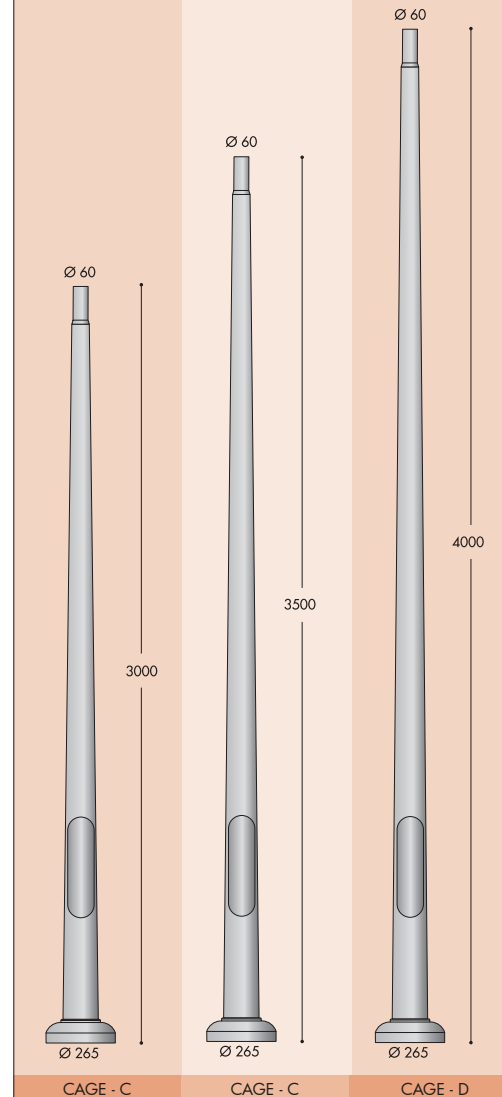
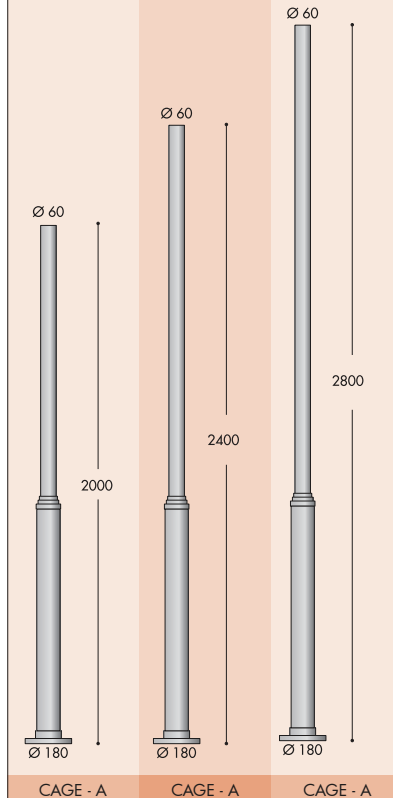
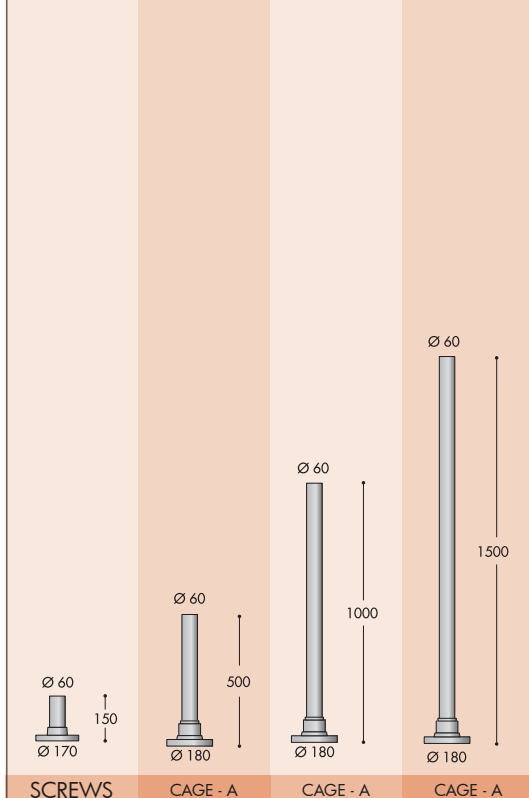

AKILLE 4500	AKILLE 5000
000.424	000.427
000.425	000.428
000.426	000.429
DOOR IS OPTIONAL	
Pcs 1 Kg 39 mc 0,238	Pcs 1 Kg 42 mc 0,265
 Ø 60 4500 Ø 265	 Ø 60 5000 Ø 265
CAGE - D	CAGE - D

EKTOR 2500	EKTOR 3000	EKTOR 3500	EKTOR 4000	EKTOR 4500	EKTOR 5000	EKTOR 6000
000.361	000.364	000.367	000.371	000.374	000.377	000.384
000.362	000.365	000.368	000.372	000.375	000.378	000.385
000.363	000.366	000.369	000.373	000.376	000.379	000.386
DOOR IS OPTIONAL						
Pcs 1 Kg 30 mc 0,159	Pcs 1 Kg 30 mc 0,159	Pcs 1 Kg 33 mc 0,185	Pcs 1 Kg 36 mc 0,212	Pcs 1 Kg 39 mc 0,238	Pcs 1 Kg 42 mc 0,265	Pcs 1 Kg 57 mc 1,21
 Ø 60 2500 Ø 265	 Ø 60 3000 Ø 265	 Ø 60 3500 Ø 265	 Ø 60 4000 Ø 265	 Ø 60 4500 Ø 265	 Ø 60 5000 Ø 265	 Ø 60 6000 Ø 265 400
CAGE - C	CAGE - C	CAGE - C	CAGE - D	CAGE - D	CAGE - D	CAGE - E

# MODERN POSTS

## MODERN POST TOP SYSTEMS

### FULLY MODULAR



All the connection hubs of FUMAGALLI poles and lanterns have a diameter of 60 mm; this unique feature allows many different possible combinations of complete lamps with the same components, for a big stock flexibility.

*I terminali di connessione dei pali e delle lanterne FUMAGALLI hanno sempre un diametro di 60 mm; questa caratteristica unica permette svariate combinazioni di lampade complete con i medesimi componenti per una grande flessibilità di magazzino.*

#### GIORGIO

4P2.000.G10

4P1.000.G10

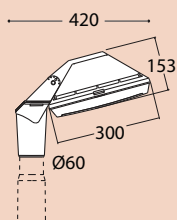

#### ROSA

4P2.000.G20

4P1.000.G20

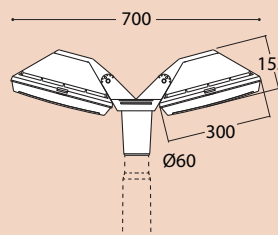

#### MIDIPILAR SYSTEM

##### MIDIPILAR SYSTEM 1L

000.000.A10

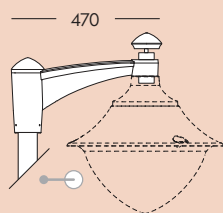

##### MIDIPILAR SYSTEM 2L

000.000.A20

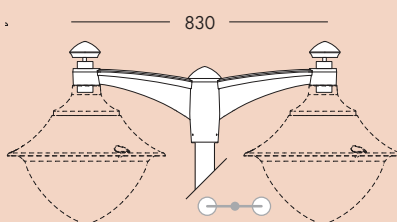

##### MIDIPILAR SYSTEM 3L

000.000.A30

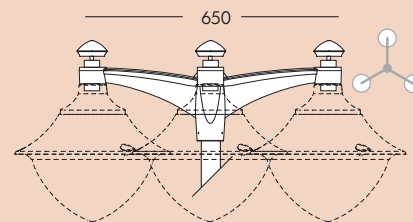

#### PILAR SYSTEM

##### PILAR SYSTEM 1L

000.000.P10

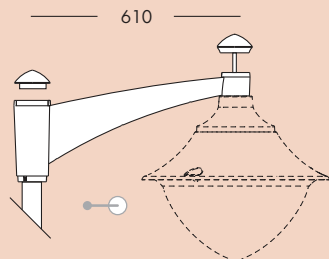

##### PILAR SYSTEM 2L

000.000.P20

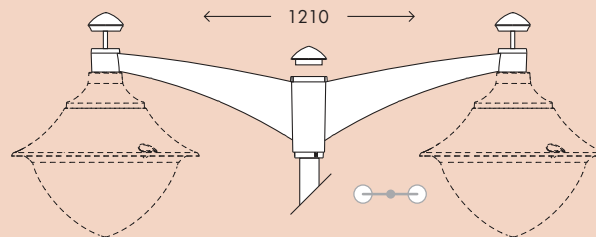

#### ELI SYSTEM

##### ELI SYSTEM 2L

000.000.L20

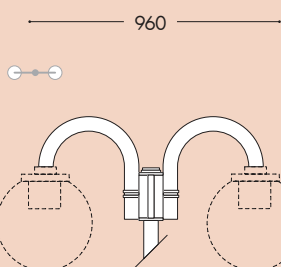

##### ELI SYSTEM 2 + 1

000.000.L21

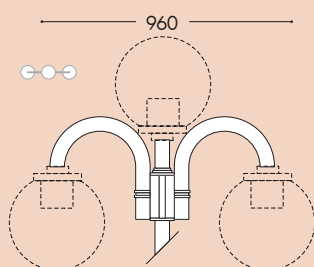

##### ELI SYSTEM 3L

000.000.L30

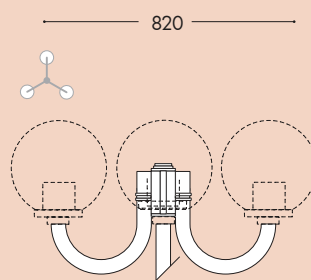

##### ELI SYSTEM 3 + 1

000.000.L31

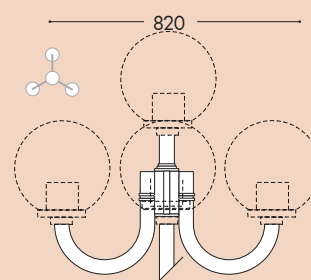

LARGE SIZE		GRAND SIZE	
<p>REMO 400 R50.000</p> <p>Ø480</p>		<p>REMO 500 R60.000</p> <p>Ø600</p>	
<p>GINO 400 F50.000</p> <p>Ø480</p>		<p>GINO 500 F60.000</p> <p>Ø600</p>	<p>BEPPE 500 P60.000</p> <p>Ø600</p>
<p>ECOVIVI 400 EV4.000</p> <p>Ø480</p>	<p>VIVI 400 V50.000</p> <p>Ø480</p>	<p>VIVI 500 V60.000</p> <p>Ø600</p>	<p>ECOVIVI 500 EV6.000</p> <p>Ø600</p>
<p>GLOBE 400 MODERN G41.B40</p> <p>Ø400</p>		<p>GLOBE 500 MODERN G51.B50</p> <p>Ø500</p>	

BULKHEAD

FLOODLIGHT

IN-GROUND

BRICKLIGHT

BOLLARDS

GARDEN

URBAN CLASSIC

URBAN MODERN

HIGH-BAY

POST

LAMPS

	LAMPS
	POST
	HIGH-BAY
	URBAN MODERN
	URBAN CLASSIC
	GARDEN
	BOLLARDS
	BRICKLIGHT
	IN-GROUND
	FLOODLIGHT
	BULKHEAD

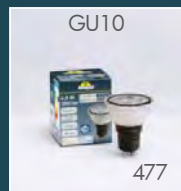
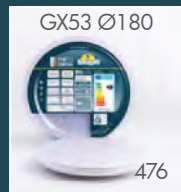
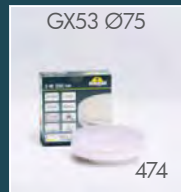

BULKHEAD

FLOODLIGHT

IN-GROUND

BRICKLIGHT

BOLLARDS

GARDEN

URBAN CLASSIC

URBAN MODERN

HIGH-BAY

POST

# LAMPS

# FUMAGALLI LED LAMPS

## MODULAR SYSTEM

Innovative TÜV certified LED lamps with standard E27, GX53 or GU10 lamp holder to get a very efficient LED lighting system. Heatsink and driver are built-in the lamps. LED modules can be easily replaced without the help a qualified technician. Available in different wattage versions and color temperature. Moreover combing in series Fumagalli GX53 lamps you get a powerful and efficient public lighting system both on classic and modern luminaries.

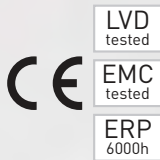
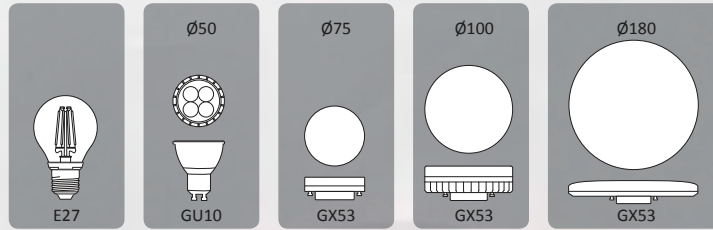

### Benefits:

- **COST SAVING:** long-life and efficient LED light sources.
- **BUILT-IN DRIVER:** quick and easy lamp replacement.
- **GREAT FLEXIBILITY:** standard lamp holder.
- **FUTURE-PROOFED LUMINARIES:** performances easy to upgrade to latest technology developments.
- **SUITABLE FOR OUTDOOR USE:** driver fully protected against heat and humidity by silicone paste.
- **TÜV CERTIFIED QUALITY:** Production monitored, CE marked, LVD and EMC test, in compliance with the Ecodesign Directive (ERP).

BULKHEAD  
FLOODLIGHT  
IN-GROUND  
BRICKLIGHT  
BOLLARDS  
GARDEN  
URBAN CLASSIC  
URBAN MODERN  
HIGH-BAY  
POST  
LAMPS



FRANCY  
up&down



ANNA  
garden



LETI 200  
recessed



CECI 120  
in-ground



GIUSEPPE  
floodlight



TOMMY  
floodlight



BEPPE 500  
urban modern



BERTA  
bulkhead



MINITOMMY-EL  
floodlight



MARTA  
up&down

BULKHEAD  
FLOODLIGHT  
IN-GROUND  
BRICKLIGHT  
BOLLARDS  
GARDEN  
URBAN CLASSIC  
URBAN MODERN  
HIGH-BAY  
POST  
LAMPS



# FUMAGALLI LED LAMPS

## E27 FILAMENT

BULKHEAD  
FLOODLIGHT  
IN-GROUND  
BRICKLIGHT  
BOLLARDS  
GARDEN  
URBAN CLASSIC  
URBAN MODERN  
HIGH-BAY  
POST  
LAMPS

### E27 LED FILAMENT A60

			<i>Power</i>	<b>6 W</b>	<b>8 W</b>
			<i>Luminous Flux</i>	<b>800 lm</b>	<b>1000 lm</b>
			<i>Efficiency</i>	133 Lm/W	125 Lm/W
			<i>Voltage</i>	100-240 V	100-240 V
			<i>Frequency</i>	50/60 Hz	50/60 Hz
			<i>Current</i>	60 mA	76 mA
			<i>Power Factor</i>	> 0,7	> 0,7
			<i>Color Rendering Index Ra</i>	> 80	> 80
			<i>Beam Angle</i>	360°	360°
			<i>Warm up time</i>	≤ 0,5"	≤ 0,5"
			<i>Switching cycle</i>	> 100.000	> 100.000
			<i>Lifetime</i>	25.000 h	25.000 h
			<i>Kelvin</i>	2700 K	2700 K
			<i>ref. code</i>	H.LED.FIL.3K	H2.LED.FIL.3K
			<i>Comparison</i>		

### E27 LED FILAMENT A70

			<i>Power</i>	<b>12 W</b>	
			<i>Luminous Flux</i>	<b>1500 lm</b>	
			<i>Efficiency</i>	125 Lm/W	
			<i>Voltage</i>	100-240 V	
			<i>Frequency</i>	50/60 Hz	
			<i>Current</i>	100 mA	
			<i>Power Factor</i>	> 0,7	
			<i>Color Rendering Index Ra</i>	> 80	
			<i>Beam Angle</i>	360°	
			<i>Warm up time</i>	≤ 0,5"	
			<i>Switching cycle</i>	> 100.000	
			<i>Lifetime</i>	25.000 h	
			<i>Kelvin</i>	2700 K	
			<i>ref. code</i>	H3.LED.FIL.3K	
			<i>Comparison</i>		

**SILICONE PROTECTION**

DRIVER



**INDOOR & OUTDOOR USE**

-30 +80 °C

90% HUMIDITY

**VOLTAGE SURGE RESISTANT**



**GOLD WIRE BONDING**

- Chips connected by pure gold wire to resist at higher temperature.



**PHOSPHOR DISPENSING**

- Filament covered by Intermatix phosphor.
- Phosphor dispensed on both side of filament allowing a better light reflection.



**CHIP ON CORD TECHNOLOGY**

- Epistar led chip bonded on pure synthetic **sapphire** substrate.
- Better shock resistance.
- High transparency and better lumen output in comparison with glass or ceramic substrate.
- Thermal expansion ratio similar as led chip.



**SAPPHIRE CHIP SUPPORT**



**GLASS BULB**

- 90% hydrogen gas inside, in order to help the heat dissipation making the lamp suitable for outdoor use.
- Filament welded and inserted into the glass by automatic process instead of by hand, to get a much more precise result.



**DRIVER 100-240V**

- Wide voltage range: 100-240V ±10% tolerance.
- Double 400V capacitors and multiple resistances to withstand the electricity peak.
- Driver fully protected by special silicone paste with metal powder inside, helping the heat dissipation and protecting all the electronic components against humidity for outdoor lamp use.





# FUMAGALLI LED LAMPS

## GX53 Ø75

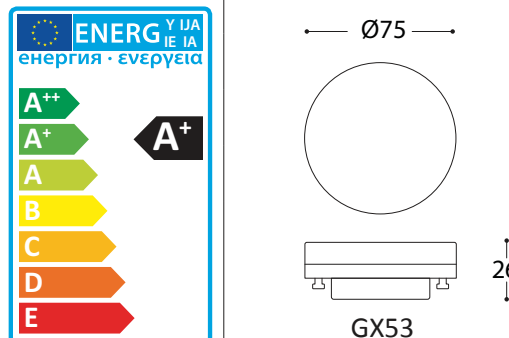
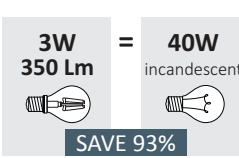

BULKHEAD  
FLOODLIGHT  
IN-GROUND  
BRICKLIGHT  
BOLLARDS  
GARDEN  
URBAN CLASSIC  
URBAN MODERN  
HIGH-BAY  
POST  
LAMPS

GX53 LED Ø75				
		Power	<b>3 W</b>	
		Luminous Flux	<b>350 lm</b>	
		Efficiency	116 lm/W	
		Voltage	100-240 V	
		Frequency	50/60 Hz	
		Current	45 mA	
		Color Rendering Index Ra	> 80	
		Beam Angle	105°	
		Warm up time	≤ 0,5"	
		Switching cycle	> 15.000	
		Lifetime	25.000 h	
		Kelvin	4000 K	3000 K
		ref. code	H.LED.G53	H.LED.G53.3K
		Comparison		
			SAVE 93%	

**INDOOR & OUTDOOR USE**

-30 +80 °C | 90% HUMIDITY

**VOLTAGE SURGE RESISTANT**



**DRIVER 100-240V**

- Wide voltage range (100-240V) ± 10%
- High quality capacitors and resistances able to withstand the electricity peak.



**GOLD WIRE BONDING**

- LED chips connected by GOLD WIRE to resist at higher temperature and grant a lumen maintenance factor >80% .
- SMD 3528 LED.

**LENS**



- Frosted effect finishing to reduce dazzling.
- Made of UV stabilized resin material to avoid yellowing process.

**PCB**

- Special design to prevent deformation in case of high temperature.

**GX53 LAMP HOLDER**

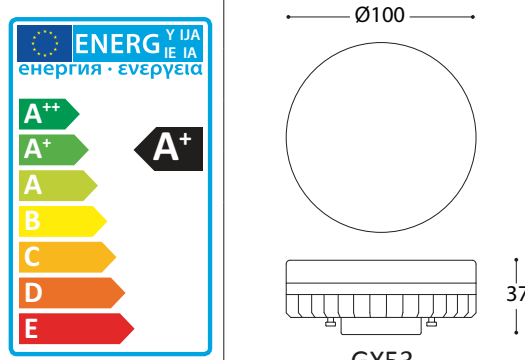
- Quick and easy lamp replacement and version upgrade.
- PBT material to resist up to 180° and 250V.
- VDE and NEMKO approved.

GX53 LED Ø100					
 <p>CE LVD tested EMC tested ERP 6000h TUV SUD</p>	Power	<b>7 W</b>		<b>10 W</b>	
	Luminous Flux	<b>800 lm</b>		<b>1200 lm</b>	
	Efficiency	114 Lm/W		120 Lm/W	
	Voltage	100-240 V		100-240 V	
	Frequency	50/60 Hz		50/60 Hz	
	Current	95 mA		130 mA	
	Power Factor	0,9		0,9	
	Color Rendering Index Ra	> 80		> 80	
	Beam Angle	105°		105°	
	Warm up time	≤ 0,5"		≤ 0,5"	
 <p>ENERGY LABEL: A+ Ø100 37 GX53</p>	Switching cycle	> 15.000		> 15.000	
	Lifetime	25.000 h		25.000 h	
	Kelvin	4000 K	3000 K	4000 K	3000 K
	ref. code	H2.LED.G53	H2.LED.G53.3K	H3.LED.G53	H3.LED.G53.3K
	Comparison	<b>7W 800 Lm</b> = <b>75W</b> incandescent  <b>SAVE 90%</b>		<b>10W 1200 Lm</b> = <b>100W</b> incandescent  <b>SAVE 90%</b>	

**SILICONE PROTECTION**

DRIVER



**INDOOR & OUTDOOR USE**

-30 +80 °C | 90% HUMIDITY

**VOLTAGE SURGE RESISTANT**



**DRIVER 100-240V**

- Protected by silicone paste with metal powder inside, for helping the heat dissipation and protecting the electronics components against humidity.
- Wide voltage range (100-240V) ± 10%.
- High quality capacitors and resistances able to withstand the electricity peak.



**GOLD WIRE BONDING**

- LED chip connected by GOLD WIRE to resist at higher temperature and grant a lumen maintenance factor >80%.
- SMD 3528 LED.

**LENS**

- Frosted effect finishing to reduce dazzling.
- Made of UV stabilized resin material to avoid yellowing process.

**GX53 LAMP HOLDER**

- Quick and easy lamp replacement and version upgrade.
- PBT material to resist up to 180° and 250V.
- VDE and NEMKO approved.

**HEATSINK**

- White painted aluminum.
- Dedicated PC ring and thermally conductive paste to ensure full heat dispersion.
- PCB made by aluminum bord.

BULKHEAD  
FLOODLIGHT  
IN-GROUND  
BRICKLIGHT  
BOLLARDS  
GARDEN  
URBAN CLASSIC  
URBAN MODERN  
HIGH-BAY  
POST  
LAMPS

# FUMAGALLI LED LAMPS

GX53 Ø180



BULKHEAD  
FLOODLIGHT  
IN-GROUND  
BRICKLIGHT  
BOLLARDS  
GARDEN  
URBAN CLASSIC  
URBAN MODERN  
HIGH-BAY  
POST  
LAMPS

GX53 LED Ø180						
	<b>Power</b>	<b>11 W</b>		<b>18 W</b>		
	<b>Luminous Flux</b>	<b>1300 lm</b>		<b>2000 lm</b>		
	<b>Efficiency</b>	118 lm/W		111 lm/W		
	<b>Voltage</b>	100-240 V		100-240 V		
	<b>Frequency</b>	50/60 Hz		50/60 Hz		
	<b>Current</b>	150 mA		200 mA		
	<b>Power Factor</b>	0,9		0,9		
	<b>Color Rendering Index Ra</b>	> 80		> 80		
	<b>Beam Angle</b>	90°		90°		
	<b>Warm up time</b>	≤ 0,5"		≤ 0,5"		
	<b>Switching cycle</b>	> 15.000		> 15.000		
	<b>Lifetime</b>	25.000 h		25.000 h		
	<b>Kelvin</b>	4000 K	3000 K	4000 K	3000 K	
	<b>ref. code</b>	H4.LED.G53	H4.LED.G53.3K	H5.LED.G53.4K	H5.LED.G53.3K	
	<b>Comparison</b>		<b>11W = 100W</b> 1300 lm incandescent <b>SAVE 89%</b>		<b>18W = 150W</b> 2000 lm incandescent <b>SAVE 88%</b>	

**SILICONE PROTECTION**

DRIVER

**INDOOR & OUTDOOR USE**

-30 +80 °C | 90% HUMIDITY

**VOLTAGE SURGE RESISTANT**

**DRIVER 100-240V**

- Protected by silicone paste with metal powder inside for helping the heat dissipation and protecting the electronics components against humidity.
- Wide voltage range (100-240V) ± 10%.
- High quality capacitors and resistances able to withstand the electricity peak.

**GOLD WIRE BONDING**

- LED chips connected by GOLD WIRE to resist at higher temperature and grant a lumen maintenance factor >80%.
- SMD 3528 LED.

**LENS**

- Frosted effect finishing to reduce dazzling.
- Made of UV stabilized resin material to avoid yellowing process.

**HEAT DISSIPATION**

- Lamp base designed to grant air circulation.
- PCB covered by copper layer on both side to help heat dissipation.

**GX53 LAMP HOLDER**

- Quick and easy lamp replacement and version upgrade.
- PBT material to resist up to 180° and 250V.
- VDE and NEMKO approved.

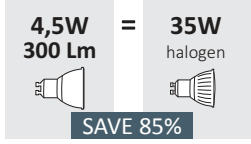
GU10 LED				
		<b>Power</b>	<b>4,5 W</b>	
		<b>Luminous Flux</b>	<b>300 lm</b>	
		<b>Voltage</b>	100-240 V	
		<b>Frequency</b>	50/60 Hz	
		<b>Current</b>	100 mA	
		<b>Color Rendering Index Ra</b>	> 80	
		<b>Beam Angle</b>	105°	
		<b>Warm up time</b>	≤ 0,5"	
		<b>Switching cycle</b>	> 15.000	
			<b>Lifetime</b>	25.000 h
		<b>Kelvin</b>	4000 K	3000 K
		<b>ref. code</b>	H.LED.GU10	H.LED.GU10.3K
		<b>Comparison</b>	 <p><b>SAVE 85%</b></p>	

**SILICONE PROTECTION**

DRIVER



**INDOOR & OUTDOOR USE**

-30 +80 °C | 90% HUMIDITY

**VOLTAGE SURGE RESISTANT**



**DRIVER 100-240V**

- Protected by silicone paste with metal powder inside, for helping the heat dissipation and protecting the electronics components against humidity.
- Wide voltage range (100-240V) ± 10%.
- High quality capacitors and resistances able to withstand the electricity peak.



**GOLD WIRE BONDING**

- LED chips connected by GOLD WIRE to resist at higher temperature and grant a lumen maintenance factor >80%.
- SMD 3528 LED.

**LENS**

- UV stabilized PMMA to avoid yellowing process.
- 4 lenses in one piece only.
- Frosted effect finishing in order to reduce dazzling.

**GU10 LAMPHOLDER**

- Quick and easy lamp replacement and version upgrade.
- Ceramic material to resist up to 250°.
- VDE approved.

**HEATSINK**

- Made by white painted aluminum.
- Thermally conductive paste to ensure full heat dispersion.

	LAMPS
	POST
	HIGH-BAY
	URBAN MODERN
	URBAN CLASSIC
	GARDEN
	BOLLARDS
	BRICKLIGHT
	IN-GROUND
	FLOODLIGHT
	BULKHEAD

# FUMAGALLI IN THE WORLD

LAMPS

POST

HIGH-BAY

URBAN MODERN

URBAN CLASSIC

GARDEN

BOLLARDS

BRICKLIGHT

IN-GROUND

FLOODLIGHT

BULKHEAD



BULKHEAD

FLOODLIGHT

IN-GROUND

BRICKLIGHT

BOLLARDS

GARDEN

URBAN CLASSIC

URBAN MODERN

HIGH-BAY

POST

LAMPS

**ITALY**



**SERBIA**



Belgrad - City Centre

**ALBANIA**



Tirana - Te Stela Hotel

**PORTUGAL**



Oeste - Praia del Rey Golf Club



**NEDERLAND**

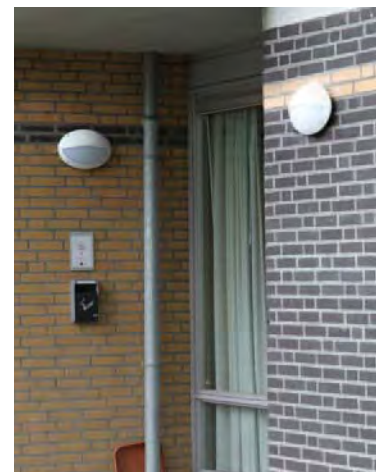
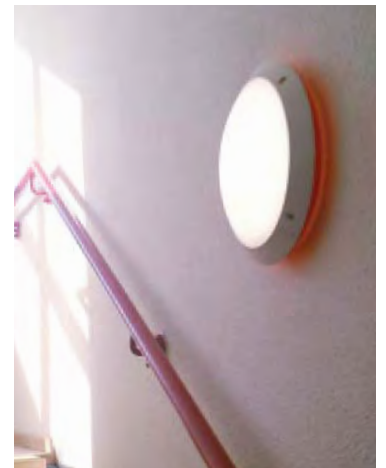



Moscow - Park Phili



Moscow - Park Phili

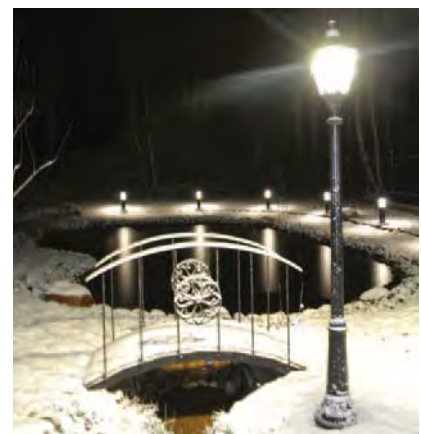

**GREAT BRITAIN**

**RUSSIA**

BULKHEAD

FLOODLIGHT

IN-GROUND

BRICKLIGHT

BOLLARDS

GARDEN

URBAN CLASSIC

URBAN MODERN

HIGH-BAY

POST

LAMPS



Cavan - Cabra Castle Hotel



Cavan - Cabra Castle Hotel

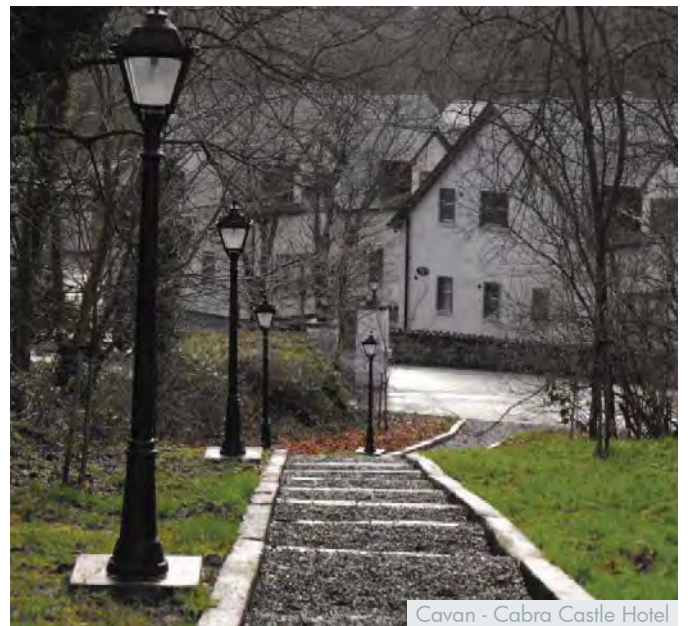

Cavan - Cabra Castle Hotel



Cavan - Cabra Castle Hotel

**IRELAND**

- BULKHEAD
- FLOODLIGHT
- IN-GROUND
- BRICKLIGHT
- BOLLARDS
- GARDEN
- URBAN CLASSIC
- URBAN MODERN
- HIGH-BAY
- POST
- LAMPS



Aigio



Athens



Paros



Paros



Zante



Paros



**GRECIA**

**CYPRUS**

BULKHEAD

FLOODLIGHT

IN-GROUND

BRICKLIGHT

BOLLARDS

GARDEN

URBAN CLASSIC

URBAN MODERN

HIGH-BAY

POST

LAMPS

BULKHEAD  
FLOODLIGHT  
IN-GROUND  
BRICKLIGHT  
BOLLARDS  
GARDEN  
URBAN CLASSIC  
URBAN MODERN  
HIGH-BAY  
POST  
LAMPS

**MALTA**





Tunisi - Sheraton Hotel



Cairo - Heliopolis Square



**TUNISIA**

**EGYPT**

BULKHEAD

FLOODLIGHT

IN-GROUND

BRICKLIGHT

BOLLARDS

GARDEN

URBAN CLASSIC

URBAN MODERN

HIGH-BAY

POST

LAMPS

BULKHEAD

FLOODLIGHT

IN-GROUND

BRICKLIGHT

BOLLARDS

GARDEN

URBAN CLASSIC

URBAN MODERN

HIGH-BAY

POST

LAMPS

**LEBANON**



Beirut - City Centre



Jieh Marina Resort



**MOROCCO**





Dubai - The Palm



Dubai - Academic City



Dubai - Nakheel Villas



Dubai - Ghorroob Mirdif Properties



Dubai - Global Village



Dubai - Academic City



Dubai - Layan Villas



Dubai - Jumeirah Beach Hotel

U.A.E.

BULKHEAD

FLOODLIGHT

IN-GROUND

BRICKLIGHT

BOLLARDS

GARDEN

URBAN CLASSIC

URBAN MODERN

HIGH-BAY

POST

LAMPS



BULKHEAD  
FLOODLIGHT  
IN-GROUND  
BRICKLIGHT  
BOLLARDS  
GARDEN  
URBAN CLASSIC  
URBAN MODERN  
HIGH-BAY  
POST  
LAMPS

**BAHRAIN**



Doha - Cornice



House of Minister of Education

**QATAR**



Doha - Sheraton Hotel





**QATAR**

BULKHEAD

FLOODLIGHT

IN-GROUND

BRICKLIGHT

BOLLARDS

GARDEN

URBAN CLASSIC

URBAN MODERN

HIGH-BAY

POST

LAMPS



Muscat - Ministry of Justice

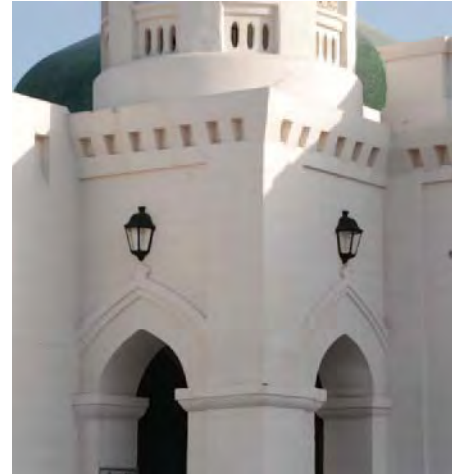

Muscat - Ministry of Justice



Muscat - Al Bustan Palace

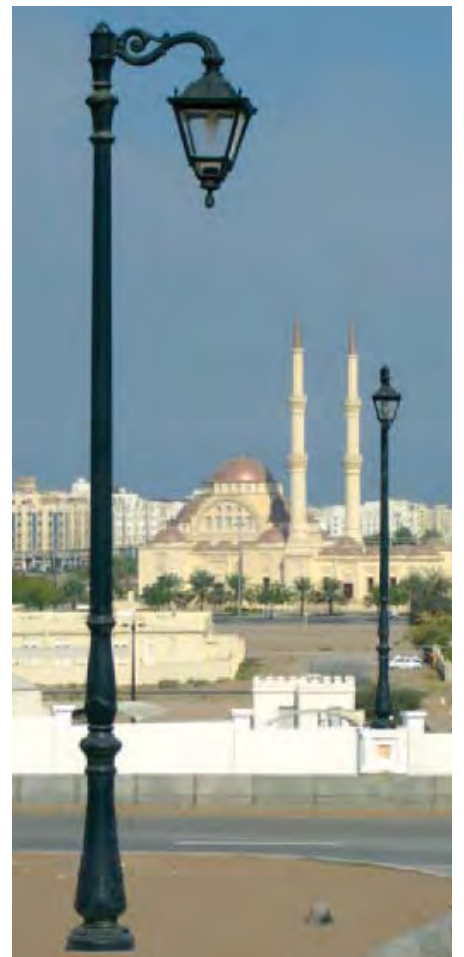

**OMAN**

- BULKHEAD
- FLOODLIGHT
- IN-GROUND
- BRICKLIGHT
- BOLLARDS
- GARDEN
- URBAN CLASSIC
- URBAN MODERN
- HIGH-BAY
- POST
- LAMPS



**SAUDI ARABIA**

BULKHEAD

FLOODLIGHT

IN-GROUND

BRICKLIGHT

BOLLARDS

GARDEN

URBAN CLASSIC

URBAN MODERN

HIGH-BAY

POST

LAMPS

BULKHEAD  
FLOODLIGHT  
IN-GROUND  
BRICKLIGHT  
BOLLARDS  
GARDEN  
URBAN CLASSIC  
URBAN MODERN  
HIGH-BAY  
POST  
LAMPS

**ISRAEL**



**INDIA**



Mahableswar



Mahableswar

**GEORGIA**

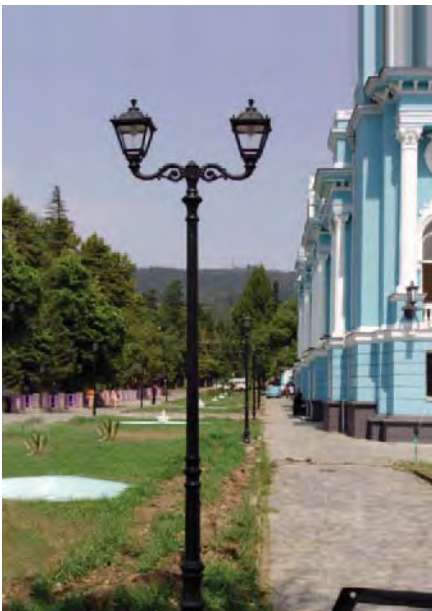



**MALAYSIA**

**THAILAND**

BULKHEAD

FLOODLIGHT

IN-GROUND

BRICKLIGHT

BOLLARDS

GARDEN

URBAN CLASSIC

URBAN MODERN

HIGH-BAY

POST

LAMPS

BULKHEAD

FLOODLIGHT

IN-GROUND

BRICKLIGHT

BOLLARDS

GARDEN

URBAN CLASSIC

URBAN MODERN

HIGH-BAY

POST

LAMPS

**TAIWAN**



Kaohsiung - Elementary school

**PHILIPPINES**



Cavite - Provincial Capitol



Lapu-Lapu Plaza



Manila - Intramuros Luneta



Manila - Intramuros



Celadon - San Lazaro



Pampanga - Provincial Capitol



Hong Kong - Portofino



Hong Kong - Shatin



Hong Kong - Ma Liu Shui



Hong Kong - Sai Kung Fuk Man Garden



**HONG KONG**

**SINGAPORE**

BULKHEAD

FLOODLIGHT

IN-GROUND

BRICKLIGHT

BOLLARDS

GARDEN

URBAN CLASSIC

URBAN MODERN

HIGH-BAY

POST

LAMPS



BULKHEAD  
FLOODLIGHT  
IN-GROUND  
BRICKLIGHT  
BOLLARDS  
GARDEN  
URBAN CLASSIC  
URBAN MODERN  
HIGH-BAY  
POST  
LAMPS

**ECUADOR**

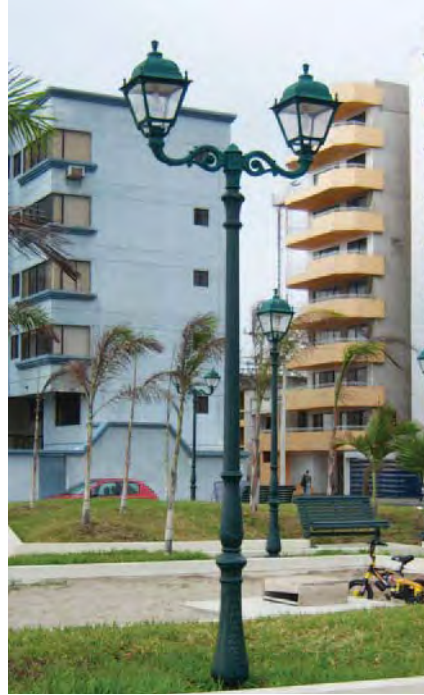

Samborondon

Samborondon

**SURINAME**



Paramaribo - Independence Square Ministry of Finance



Fumagalli S.r.l.  
Via Ca' Bassa, 29  
21100 Varese - ITALY  
Tel. +39.0332.336353  
Fax. +39.0332.336358  
E-mail [italian.lux@fumagalli.it](mailto:italian.lux@fumagalli.it)



[www.fumagalli.it](http://www.fumagalli.it)