

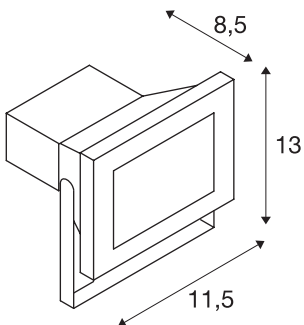

LED Outdoor BEAM

silver-grey, 10W, 5700K, 100°, IP65

Powerful OUTDOOR BEAM spot for illuminating areas and spaces. With a tiltable installation bracket and protection class IP65, the spot is suitable for outdoor installation on the wall, ceiling or on the floor. The electrical connection of the spot, which is available in warm white and neutral white, is made directly by the built-in driver and the connection lead with mains plug to the 230V mains supply. An earth spike is available as an option for simplified floor installation.



TECHNICAL DATA

Item no.:	1001633
Lamps included	0
Primary nominal voltage	220-240V ~50/60Hz mA/V
Secondary power / secondary voltage	120 mA/V
Vertical tilting range	90 °
Length	11.3 cm
Width	8.5 cm
Height	13.0 cm
Net weight	0.756 kg
Gross weight	0.836 kg
IP Code	IP 65
Safety class	I
Impact resistance class	IK04
Impact resistance	0,5 Joule
Assembly	Surface
Assembly details	Ceiling,Ground,Wall
Wattage	11 W
Lumen	800 lm
Colour temperature	5700 Kelvin
Beam angle	100 °
Color	grey
CRI	>80

Accessories

234344	WALL MOUNTING BRACKET , for OUT-DOOR BEAM and MILOX, silver, 50 cm
234354	WALL MOUNTING BRACKET , for OUT-DOOR BEAM and MILOX, silver, 80 cm
900011	PLASTIC EARTH SPIKE , black, length 17.5cm

Binning	5
LXXBXX data	70/50
Service life	30000 h
Maximum ambient temperature	40 °C

Notes
