

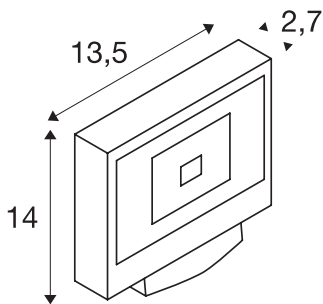

## SPOODI SENSOR

LED Outdoor surface-mounted wall light, 11W, silver-grey, 3000K

SPOODI SENSOR powerful LED spotlight, for illuminating areas and spaces. By means of the swivelling mounting bracket and its IP65 protection class, the spotlight is suitable for mounting on exterior walls. The spotlight is connected directly to the 230V mains voltage supply. The spotlight, which is available with two different housings and light colours and also wattages, has a built-in infrared motion sensor. This is easy to adjust using the remote control.



## TECHNICAL DATA

Item no.:	232864
Lamps included	0
Number of different light outlets	1
Primary nominal voltage	220-240V ~50/60Hz mA/V
Vertical tilting range	90 °
Length	13.5 cm
Width	2.7 cm
Height	14.0 cm
Net weight	0.8 kg
Gross weight	0.856 kg
IP Code	IP 65
Safety class	I
Impact resistance class	IK04
Impact resistance	0,5 Joule
Assembly	Surface
Assembly details	Wall
Wattage	11 W
Lumen	800 lm
Colour temperature	3000 Kelvin
Beam angle	90 °
Color	grey
CRI	>80



<b>Binning</b>	6
<b>LXXBXX data</b>	70/50
<b>Service life</b>	30000 h
<b>Minimum ambient temperature</b>	-10 °C
<b>Maximum ambient temperature</b>	40 °C
<b>BIG WHITE Page</b>	633

**Notes**

---

---

---

---

---