

SPOODI SENSOR

LED Outdoor surface-mounted wall light, 30W, black, 3000K

SPOODI SENSOR powerful LED spotlight, for illuminating areas and spaces. By means of the swivelling mounting bracket and its IP65 protection class, the spotlight is suitable for mounting on exterior walls. The spotlight is connected directly to the 230V mains voltage supply. The spotlight, which is available with two different housings and light colours and also wattages, has a built-in infrared motion sensor. This is easy to adjust using the remote control.

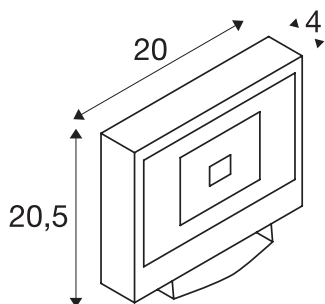

TECHNICAL DATA

Item no.:	232880
Lamps included	0
Number of different light outlets	1
Primary nominal voltage	220-240V ~50/60Hz mA/V
Vertical tilting range	90 °
Length	20.0 cm
Width	4.0 cm
Height	20.5 cm
Net weight	1.509 kg
Gross weight	1.643 kg
IP Code	IP 65
Safety class	I
Impact resistance class	IK04
Impact resistance	0,5 Joule
Assembly	Surface
Assembly details	Wall
Wattage	30 W
Lumen	2250 lm
Colour temperature	3000 Kelvin
Beam angle	100 °
Color	black
CRI	>80

Accessories

234340	Wall bracket , for Outdoor Beam and MILOX floodlight, black, 50cm
234344	WALL MOUNTING BRACKET , for OUTDOOR BEAM and MILOX, silver, 50 cm
234350	WALL BRACKET , for SPOODI 15/20/31, black, 80 cm
234354	WALL MOUNTING BRACKET , for OUTDOOR BEAM and MILOX, silver, 80 cm

Binning	6
LXXBXX data	70/50
Service life	30000 h
Minimum ambient temperature	-10 °C
Maximum ambient temperature	40 °C
BIG WHITE Page	633

Notes
