



Residual current circuit breakers with integral overcurrent protection DIFO

EVE



Build-in switch, Build-in devices



Control equipment



RF Control Wireless System

ETICON



Modular contactors for installation into distribution boards



Miniature and auxiliary contactors CE, CEC



Motor contactors CEM



Motor protective circuit breakers MPE&MS

ETIBREAK



Low breaking capacity MCCBs, Low voltage MCCBs and low voltage switch disconnectors



Low voltage moulded case circuit breakers with residual current protection



Accessories

Load Break Change Over Switch LBS..CO

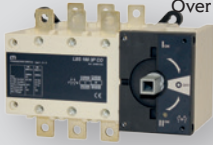

Motorised Change Over Load Break Switch MLBS..CO



Fuse Load Break Switch FLBS



Rotary Cam Switches



Surge arresters group B-F



Surge arresters group WENT



Surge arrester ETITEC S group C IEC 61643-11

ETITRAFO

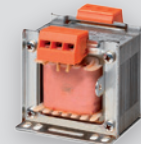

Single phase safety and insulating transformers

C



Low voltage cylindrical fuse-links CH



Fuse disconnectors for cylindrical fuse-links EFD



Fuse disconnectors for cylindrical fuse-links PCF

NV/NH



Low voltage NH knife-blade fuse-links (gL/gG)

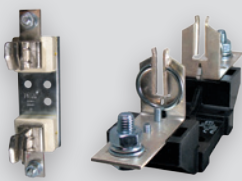

Fuse bases



Low voltage fuse-rails



Strip type fuse-switch-disconnectors



Disconnectors with fuses



Metal enclosures

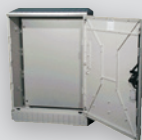

Free-standing cable distribution cabinets

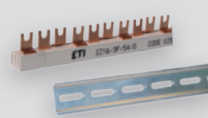

Section rails fork, pin and SKN type, DIN rails



Din rail distribution blocks EDB

Building, Industry and Energy Catalogue

ULTRA QUICK



Fuses for semiconductor devices protection

Ultra Quick Catalogue

GREEN PROTECT



Protection of Photovoltaic Systems and other renewable energy sources

Green Protect Catalogue



SUBSIDIARIES

ETI Proplast d.o.o.

Obrezija 5, 1411 Izlake, Slovenia
Phone: +386 3 56 57 590
E-mail: etiproplast@eti.si
<http://www.etiproplast.si>

ETI DE GmbH

Dorfwiesenweg 13, 63828 Kleinkahl, Germany
Phone: +49 6024 6397-0
E-mail: contact@eti-de.de
<http://www.eti-de.de>

ETI POLAM Sp. z o.o.

Ul. Jana Pawla II 18, 06100 Pultusk, Poland
Phone: +48 23 691 93 00
E-mail: etipolam@etipolam.com.pl
<http://www.etipolam.com.pl>

ETI SARAJEVO d.o.o.

Hifzi Bjelevca 13, 71 000 Sarajevo, BiH
Phone: +387 33 77 52 50
E-mail: etisa@bih.net.ba
<http://www.eti.ba>

ETI ELB s.r.o.

Potočná 42, 90084 Báhoň, Slovakia
Phone: +421-33645 52 92
E-mail: etielb@etielb.sk
<http://www.etielb.sk>

ETI UKRAINE, LTD

Ul. Akademika Tupoleva 19a, of. 216,
04128 Kiev, Ukraine
Phone: +380 44 494 21 80
E-mail: office@eti.ua
<http://www.eti.ua>

ETIBALTUS, UAB

Tilzes 41a, 47187 Kaunas, Lithuania
Phone: +370 37 261 582
E-mail: info@etibaltus.lt
<http://www.etibaltus.lt>

ETI B

Brače Jerković 120, 11000 Belgrade,
Serbia
Phone: +381 (0)11 3961 688
E-mail: miodrag.stojkovic@etib.rs
<http://www.etib.rs>

ETI HU Elektrotechnikai, Kft.

Rokolya utca 25, 1131 Budapest, Hungary
Phone: +36 1 238 0784
E-mail: eti@eti-hu.hu
<http://www.eti-hu.hu>

ETI ROMANIA S.R.L.

Str. Doina, Nr. 17,
Sector 5,
Bucharest, Romania
Phone: +40 (0)21 317 1743
E-mail: vasilije.ljuba@eti.si
<http://www.etigroup.ro>

ETI Elektroelement d.o.o.

For technical engineering and store
of electrotechnical products
Ljudevita Posavskog 47, Velika Gorica
<http://www.eti.si/hr>

ETI Branch in Russia

Rublevskoe shose 36/2, Of. 321,
121609 Moscow, Russia
Phone: +7(4)95 415 42 29
E-mail: info.eti@col.ru
<http://www.etimoskva.ru>

ETI Prostik d.o.o.

Production, sales, designing and consulting
Gabrsko 12, 1410 Trbovlje, Slovenia
Phone: +386 3 5657 570
E-mail: etiprostik@eti.si
<http://www.etigroup.eu>

PARENT COMPANY

ETI d.d.

Obrezija 5, 1411 Izlake, Slovenia
Phone: +386 3 5657 570
E-mail: eti@eti.si
<http://www.etigrorp.eu>
<http://www.eti.si>

ASSOCIATED COMPANIES

ITALWEBER S.p.A.

Via Risorgimento 84, 20017 Rho, Milano, Italy
Phone: +39 02 939 771
E-mail: info@italweber.it
<http://www.italweber.it>

SOLID GSX

METAL ENCLOSURES TYPE GT (IP65)	5
METAL ENCLOSURES WALL - MOUNTED TYPE 4XN160 (IP 41, 42, 44) AND FLUSH - MOUNTED TYPE 4XP160 (IP 42, 44)	14
INTERNAL STRUCTURAL SYSTEM AND ACCESSORIES	21

METAL ENCLOSURES SYSTEM - SAFETY CLASS I



IP Ratings (Ingress Protection)

A two-digit number established by the International Electro Technical Commission, is used to provide an Ingress Protection rating to a piece of electronic equipment or to an enclosure for electronic equipment.

The protection class after EN60529 are indicated by short symbols that consist of the two code letters IP and a code numeral for the amount of the protection.

Example: IP65 (NEMA 4)

The two digits represent different forms of environmental influence:

- The first digit represents protection against ingress of solid objects.
- The second digit represents protection against ingress of liquids.

The larger the value of each digit, the greater the protection. As an example, a product rated IP54 would be better protected against environmental factors than another similar product rated as IP42.

Technical data		
IP..	First digit:	Second digit:
	Ingress of solid objects	Ingress of liquids
0	No protection	No protection
1	Protected against solid objects over 50mm e.g. hands, large tools.	Protected against vertically falling drops of water or condensation.
2	Protected against solid objects over 12.5mm e.g. hands, large tools.	Protected against falling drops of water, if the case is disposed up to 15 from vertical.
3	Protected against solid objects over 2.5mm e.g. wire, small tools.	Protected against sprays of water from any direction, even if the case is disposed up to 60 from vertical.
4	Protected against solid objects over 1.0mm e.g. wires.	Protected against splash water from any direction.
5	Limited protection against dust ingress. (no harmful deposit)	Protected against low pressure water jets from any direction. Limited ingress permitted.
6	Totally protected against dust ingress.	Protected against high pressure water jets from any direction. Limited ingress permitted.
7	N/A	Protected against short periods of immersion in water.
8	N/A	Protected against long, durable periods of immersion in water.
9k	N/A	Protected against close-range high pressure, high temperature spray downs.

IP protection of the PIP:

A PIP in the standard PIP housing is generally IP51 protected. Higher IP protection level with the standard PIP housing (up to IP54) can be reached with good positioning / orientation of the PIP. In other special PIP-housings, like a MIL-housing up to IP67 protection is possible.

IP protection of the PANEL-PIP:

The PANEL-PIP is available in various housings. Those allow a protection level of up to all around IP65.

METAL ENCLOSURES TYPE GT (IP65)

Application:

GT-type metal enclosures cover a wide range of applications both for industrial and civil buildings. Due to its design they provide excellent air tightness, mechanical strength and functionality. They are used in places where electrical equipment is exposed to adverse effect of factors such as water, dust, mechanical impact.

Features:

- The door opening in the external enclosure contour, which allows direct connection in series of several enclosures (special design of hinges)
- High quality of polyurethane gasket - by using the newest technology in pouring of seal
- Enclosures made of high quality sheet steel
- Mechanically resistant (ex. against of hits) - IK10
- The doors in enclosures of height of 400mm and more, and width of 800mm, are equipped with vertical and horizontal reinforcements with mounting holes spaced 25mm
- Polyester powder - painted for external applications, although the enclosure are intended for internal applications.
- UV resistant

Technical data	
Degree of protection	IP65
Mechanical strength	IK10
Colour	Light grey/RAL 7035
Paint	Polyester powder
Standards	IEC/EN 62208 IEC/EN 60529 IEC 62262
Directives	RoHS

Enclosures are delivered as complete with:

- Cover of cable flange with fastening elements
- Mounting plate with fastening elements
- Key (KEY-D5-M)
- Doors with lock (LK-D3-M22)
- Plugs of mounting holes
- Earthing set (wires are not included)



Features and technical characteristics:



Enclosures made of high quality sheet steel thickness from 1.2 mm to 2 mm.
Resistant to external mechanical impacts - IK10.



Polyester powder paint RAL 7035 for external applications. *



Specially profiled edges of the housing ensure stiffness and exact protection against water.



Poured polyurethane gasket on the door providing IP65 protection.



Cable flanges with curved edges to stiffen and poured gasket provides excellent cover.



Door opening angle up to 120 degrees.



The door opening in the external enclosure contour, which allows direct connection in series of several enclosures (special design of hinges)



The door assembled on the left or right side.



Door closing depending on the dimensions of enclosures: 1 lock for heights up to 400 mm.



Door closing depending on the dimensions of enclosures: 2 locks for heights of 500 mm and more.



Door closing depending on the dimensions of enclosures: 3-points closure for heights of 1000 mm and more.



The doors in enclosures for heights of 400 mm and more, are equipped with vertical reinforcements with mounting holes spaced 25 mm.



The doors in enclosures for heights of 400 mm and more are equipped with horizontal reinforcements with mounting holes spaced 25 mm.



Solid construction of 3-point fasteners.



Enclosures for heights of 800 mm and more are equipped with three hinges.



The body and door M6x12 mm earth terminals.



Mounting to the wall directly or with a special wall holder -set (separate ordered). The diameter of holes on the back plate of the body is $\varnothing 10$ mm.



Mounting plate is made of galvanized steel sheet with a thickness of 2 mm. Mounting plate is fixed to the body with screws M8x25 mm. Depending on the size, special foldings of the plate edge are made for better stiffness.

Symbols:

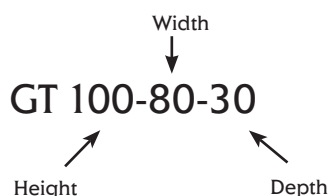

Enclosures GT with mounting plate

Type	Code	Height (mm)	Width X (mm)	Depth Z (mm)	Max. quantity of moduls (18mm) using a mounting holder		Lock quantity	Hinges quantity	Weight (kg)
GT 25-20-15	001123100	250	200	150	-	-	1	2	3,61
GT 30-20-15	001102101	300	200	150	-	-	1	2	4,14
GT 30-30-15	001102102	300	300	150	-	-	1	2	5,65
GT 30-30-20	001102103	300	300	200	-	-	1	2	6,38
GT 30-30-25	001102104	300	300	250	-	-	1	2	7,13
GT 40-30-15	001102105	400	300	150	2x12	24	1	2	7,07
GT 40-30-20	001102106	400	300	200	2x12	24	1	2	7,90
GT 40-30-25	001102107	400	300	250	2x12	24	1	2	8,74
GT 40-40-15	001102108	400	400	150	2x17	34	1	2	8,92
GT 40-40-20	001102109	400	400	200	2x17	34	1	2	9,90
GT 40-40-25	001102110	400	400	250	2x17	34	1	2	10,89
GT 40-60-20	001102111	400	600	200	2x26	52	1	2	14,57
GT 40-60-25	001102112	400	600	250	2x26	52	1	2	15,87
GT 40-60-30	001102113	400	600	300	2x26	52	1	2	17,17
GT 50-40-15	001102114	500	400	150	3x17	51	2	2	10,69
GT 50-40-20	001102115	500	400	200	3x17	51	2	2	11,17
GT 50-40-25	001102116	500	400	250	3x17	51	2	2	12,86
GT 50-55-20	001102117	500	550	200	3x24	72	2	2	15,30
GT 50-55-25	001102118	500	550	250	3x24	72	2	2	16,62
GT 60-40-15	001102119	600	400	150	3x17	51	2	2	12,47
GT 60-40-20	001102120	600	400	200	3x17	51	2	2	13,64
GT 60-40-25	001102121	600	400	250	3x17	51	2	2	14,82
GT 60-60-20	001102122	600	600	200	3x26	78	2	2	20,02
GT 60-60-25	001102123	600	600	250	3x26	78	2	2	21,51
GT 60-60-30	001102124	600	600	300	3x26	78	2	2	22,99
GT 60-80-30	001102125	600	800	300	3x36	108	2	2	32,65
GT 65-55-20	001102126	650	550	200	4x24	96	2	2	19,86
GT 65-55-25	001102127	650	550	250	4x24	96	2	2	21,32
GT 80-40-20	001102128	800	400	200	5x17	85	2	3	19,45
GT 80-40-25	001102129	800	400	250	5x17	85	2	3	21,11
GT 80-55-20	001102130	800	550	200	5x24	120	2	3	26,17
GT 80-55-25	001102131	800	550	250	5x24	120	2	3	28,11
GT 80-60-20	001102132	800	600	200	5x26	130	2	3	28,13
GT 80-60-25	001102133	800	600	250	5x26	130	2	3	30,14
GT 80-60-30	001102134	800	600	300	5x26	130	2	3	32,17
GT 80-60-40	001102135	800	600	400	5x26	130	2	3	36,20
GT 80-80-20	001102136	800	800	200	5x36	180	2	3	35,93
GT 80-80-25	001102137	800	800	250	5x36	180	2	3	38,31
GT 80-80-30	001102138	800	800	300	5x36	180	2	3	40,68
GT 80-80-40	001102139	800	800	400	5x36	180	2	3	45,44
GT 80-100-30	001102140	800	1000	300	5x46	230	2	3	49,20
GT 80-100-40	001102141	800	1000	400	5x46	230	2	3	54,67
GT 100-60-25	001102142	1000	600	250	6x26	156	3 p	3	36,35
GT 100-60-30	001102143	1000	600	300	6x26	156	3 p	3	38,60
GT 100-60-40	001102144	1000	600	400	6x26	156	3 p	3	43,10
GT 100-80-25	001102145	1000	800	250	6x36	216	3 p	3	46,11
GT 100-80-30	001102146	1000	800	300	6x36	216	3 p	3	48,72
GT 100-80-40	001102147	1000	800	400	6x36	216	3 p	3	53,94
GT 100-100-25	001102148	1000	1000	250	6x46	276	3 p	3	55,87
GT 100-100-30	001102149	1000	1000	300	6x46	276	3 p	3	58,83
GT 100-100-40	001102150	1000	1000	400	6x46	276	3 p	3	64,78
GT 120-60-25	001102151	1200	600	250	7x26	182	3 p	3	42,55
GT 120-80-25	001102152	1200	800	250	7x36	252	3 p	3	53,90
GT 120-80-30	001102153	1200	800	300	7x36	252	3 p	3	56,76
GT 120-80-40	001102154	1200	800	400	7x36	252	3 p	3	62,45
GT 120-100-30	001102155	1200	1000	300	7x46	322	3 p	3	68,47
GT 120-100-40	001102156	1200	1000	400	7x46	322	3 p	3	74,88

Note: The other parameters are on the next page.

Enclosures GT with mounting plate

Type	Cable entry depth B1 (mm)	Cable entry width A1 (mm)	Cover cable entry depth B (mm)	Cover cable entry width A (mm)	Enclosure load (kg)	Mounting plate load (kg)	The doors load * (kg)	Max. allowed power losses when max. number of devices are installed (W)	Packaging (pcs.)
GT 25-20-15	70	140	110	180	150	125	25	11	1
GT 30-20-15	70	140	110	180	150	125	25	14	1
GT 30-30-15	70	240	110	280	150	125	25	17	1
GT 30-30-20	120	240	160	280	150	125	25	21	1
GT 30-30-25	170	240	210	280	175	150	25	20	1
GT 40-30-15	70	240	110	280	175	150	25	22	1
GT 40-30-20	120	240	160	280	175	150	25	25	1
GT 40-30-25	170	240	210	280	175	150	25	28	1
GT 40-40-15	70	340	110	380	175	150	25	25	1
GT 40-40-20	120	340	160	380	225	200	25	30	1
GT 40-40-25	170	340	210	380	225	200	25	25	1
GT 40-60-20	120	540	160	580	225	200	25	40	1
GT 40-60-25	170	540	210	580	225	200	25	46	1
GT 40-60-30	170	540	210	580	225	200	25	36	1
GT 50-40-15	70	340	110	380	225	200	25	30	1
GT 50-40-20	120	340	160	380	225	200	25	40	1
GT 50-40-25	170	340	210	380	225	200	25	41	1
GT 50-55-20	120	490	160	530	225	200	25	42	1
GT 50-55-25	170	490	210	530	225	200	25	45	1
GT 60-40-15	70	340	110	380	225	200	25	38	1
GT 60-40-20	120	340	160	380	225	200	25	40	1
GT 60-40-25	170	340	210	380	225	200	25	46	1
GT 60-60-20	120	540	160	580	275	250	25	55	1
GT 60-60-25	170	540	210	580	275	250	25	60	1
GT 60-60-30	170	540	210	580	275	250	25	66	1
GT 60-80-30	170	740	210	780	275	250	25	82	1
GT 65-55-20	120	490	160	530	275	250	25	51	1
GT 65-55-25	170	490	210	530	275	250	25	55	1
GT 80-40-20	120	340	160	380	275	250	25	53	1
GT 80-40-25	170	340	210	380	275	250	25	58	1
GT 80-55-20	120	490	160	530	275	250	25	62	1
GT 80-55-25	170	490	210	530	275	250	25	65	1
GT 80-60-20	120	540	160	580	325	300	25	70	1
GT 80-60-25	170	540	210	580	325	300	25	78	1
GT 80-60-30	170	540	210	580	325	300	25	101	1
GT 80-60-40	170	540	210	580	325	300	25	87	1
GT 80-80-20	120	740	160	780	325	300	25	70	1
GT 80-80-25	170	740	210	780	325	300	25	80	1
GT 80-80-30	170	740	210	780	325	300	25	104	1
GT 80-80-40	170	740	210	780	390	350	25	117	1
GT 80-100-30	170	940	210	980	390	350	25	123	1
GT 80-100-40	170	940	210	980	390	350	25	125	1
GT 100-60-25	170	540	210	580	390	350	40	92	1
GT 100-60-30	170	540	210	580	390	350	40	100	1
GT 100-60-40	170	540	210	580	390	350	40	115	1
GT 100-80-25	170	740	210	780	390	350	40	113	1
GT 100-80-30	170	740	210	780	390	350	40	123	1
GT 100-80-40	170	740	210	780	390	350	40	128	1
GT 100-100-25	170	940	210	980	390	350	40	118	1
GT 100-100-30	170	940	210	980	390	350	40	122	1
GT 100-100-40	170	940	210	980	390	350	40	130	1
GT 120-60-25	170	540	210	580	390	350	40	110	1
GT 120-80-25	170	740	210	780	390	350	40	116	1
GT 120-80-30	170	740	210	780	390	350	40	150	1
GT 120-80-40	170	740	210	780	390	350	40	160	1
GT 120-100-30	170	940	210	980	390	350	40	166	1
GT 120-100-40	170	940	210	980	390	350	40	170	1

* NOTE: The doors load is given for closed enclosure in vertical position. The load of doors in open position over angle 120 degrees may damage the enclosure.

Accessories

Accessories for hermetic enclosures (IP65) with mounting plate

Type	Code	Description	Weight (kg)	Packaging (pcs.)
U400	001102166	Wall holders - set	0,37	1
LK-D3-M22	001102167	Lock D3	0,07	1
LK-D5-M22	001102168	Lock D5	0,07	1
LK-KW8-M22	001102169	Lock DW	0,07	1
LK-T9-M22	001102170	Lock T9	0,07	1
LK-1333-M22	001102171	Patent lock 1333	0,09	1
LK-B1333-M22	001102172	Patent lock 1333 with knob	0,12	1
LK-CB1333-25-50	001102180	Lock for toothed mechanism (3-points lock**)	0,15	1
KEY-D5-M	001102173	Key D5 metal	0,04	1
KEY-T9-M	001102174	Key T9 metal	0,04	1
KEY-KW8-M	001102175	Square key 8mm	0,04	1
KEY-UNI-M	001102176	Universal key	0,07	1
LPE-6	001102177	PE set 6mm ²	0,02	1
K-A4	001102178	Documentation A4 pocket	0,16	1
FA-RAL7035	001101710	Repair paint RAL7035 (200 ml)	0,23	1



U400



LK-D3-M22*
(bolt-3 mm)



LK-D5-M22
(bolt-5 mm)



LK-KW8-M22
(bolt square-8 mm)



LK-T9-M22
(bolt triangle 9 mm)



K-1333-M22



LK-B1333-M22



LK-CB1333-25-50**



KEY-D5-M*



KEY-T9-M



KEY-KW8-M



KEY-UNI-M
(for locks D5, T9, KW8, N)



LPE-6



K-A4



FA-RAL7035

* - standard equipment for enclosures height ≤ 800 mm

** - lock for 3-points fastening for enclosures height ≥ 1000 mm

Dimensions of GT enclosures

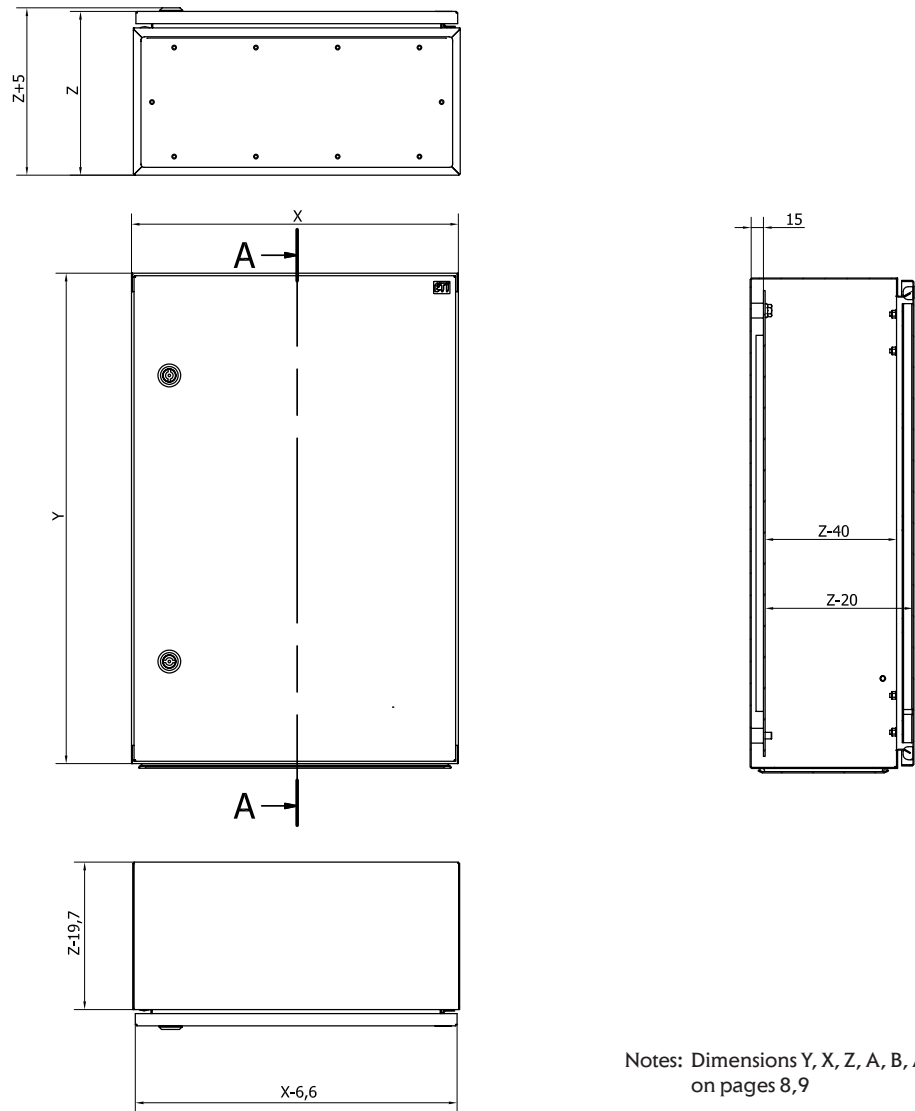

Notes: Dimensions Y, X, Z, A, B, A1, B1 are on pages 8,9

Dimensions of doors

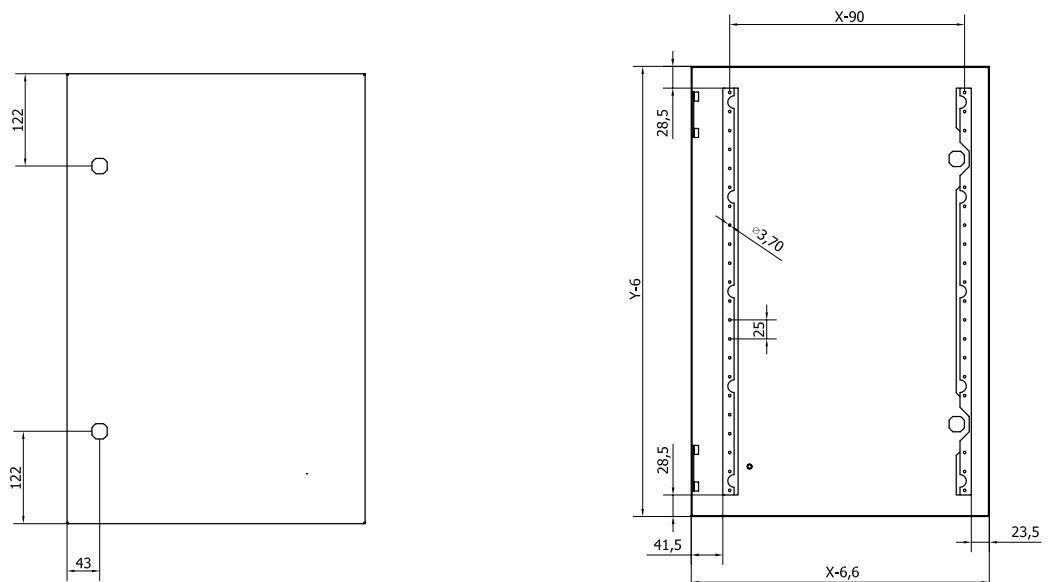

Dimensions of doors

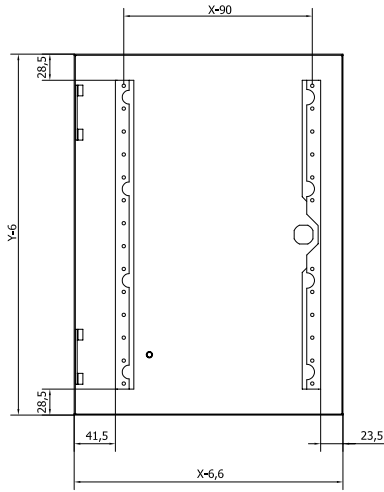

Door with one lock

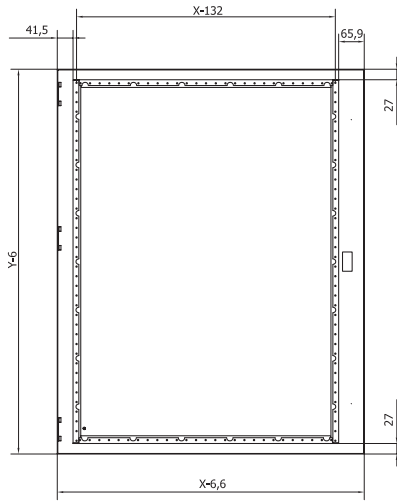

Door with one 3-points lock

Dimensions of the body of enclosure GT

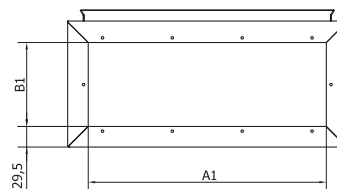
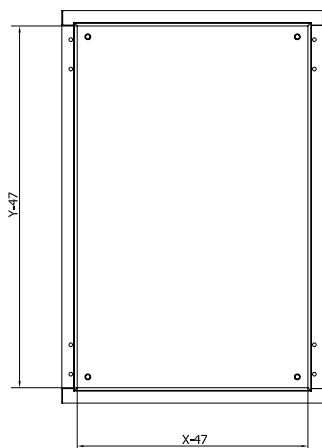
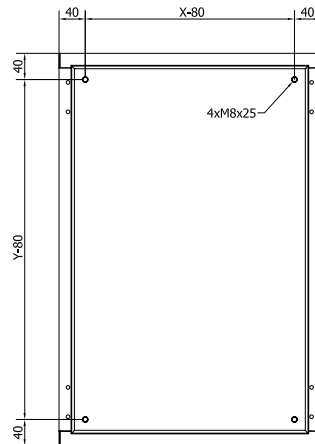
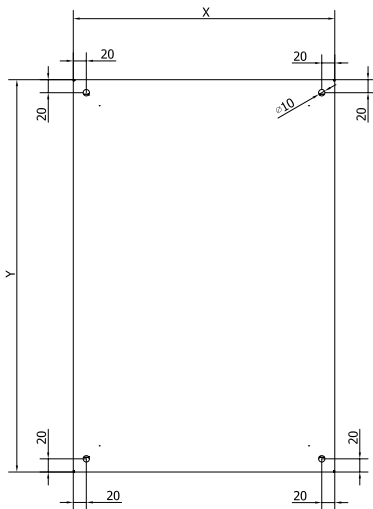

Dimension of flange

Dimensions of holder, mounting plates, holes for locks

Wall holder U400

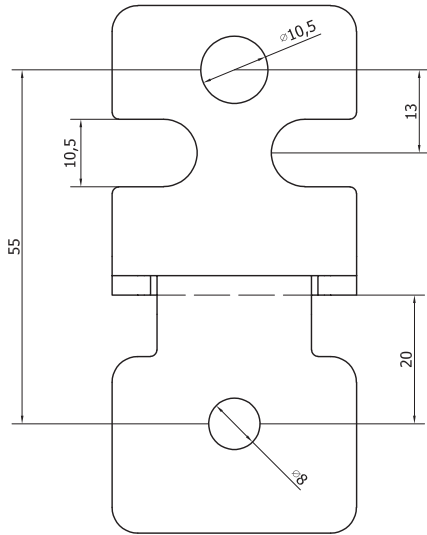

Mounting plates

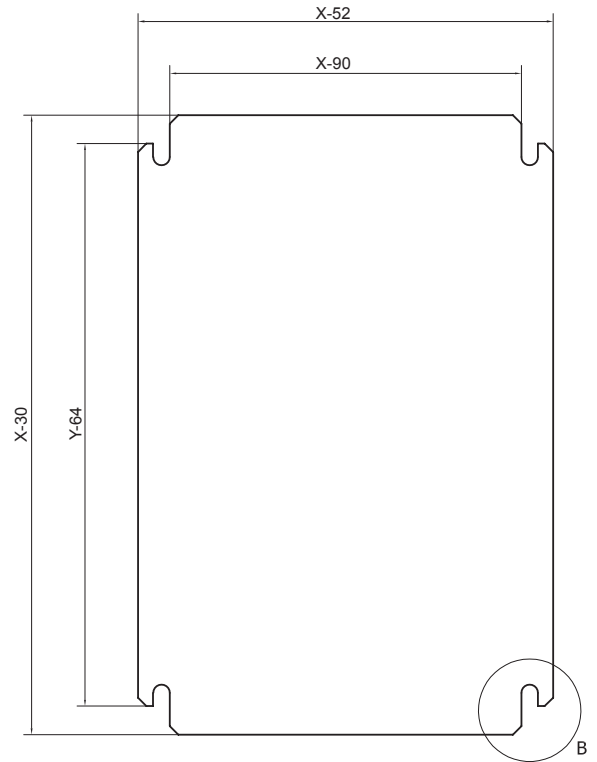

Holes in the door for locks

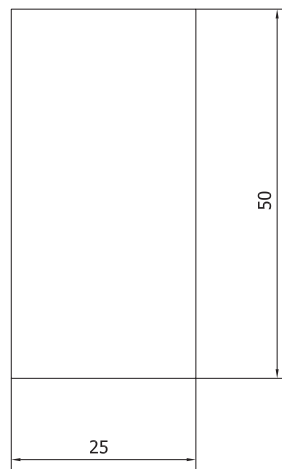
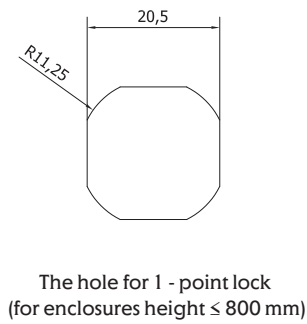

The hole for 3 - points lock
(for enclosures height ≥ 1000 mm)

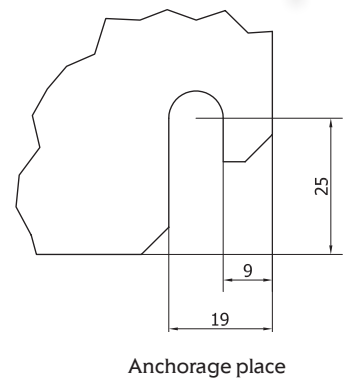

METAL ENCLOSURES WALL - MOUNTED TYPE 4XN160 (IP 41, 42, 44) AND FLUSH - MOUNTED TYPE 4XP160 (IP 42, 44)

Advantages:

- High versatility and flexibility
- Removable mounting framework (can be wired in the workshop or on the site)
- Easy vertical dividing of enclosure by using special separating elements EPW
- Covers and mounting plates are dedicated for ETI devices (MCCB's, MCB's, RCBO's disconnectors, etc.)
- Short assembling time
- Demountable back plate in wall-mounted version
- Demountable door frame in flush-mounted version
- Two door locks with keys in standard equipment (code of key 1333)
- High quality membrane cable flanges
- Elements are precisely made of high quality 1mm thickness sheet steel powder-coated
- Painted with polyester paint - UV resistant

Application:

Metal enclosures are available in two types: wall-mounted 4XN160 with protection degree IP41 (IP42, IP44) depth 160 mm and flush-mounted 4XP160 with protection degree IP42 (IP44), the depth of the cassette 160 mm. Safety class 1.

Technical data

Safety class (total insulation)	I
Protection degree	Wall-mounted 4XN160 - IP41/IP42/IP44 Flush-mounted 4XP160 - IP42/IP44
Degree of protection against mechanical impact	IK10
Colour	Light grey (RAL 7035)
Type of paint	Polyester
Mounting place	Indoor use
Ambient temperature	-5°C ... +40°C
Standards	IEC/EN 62208, IEC/EN 60529, IEC/EN 62262
Directives	RoHS

Mechanical load

Mounting framework (WP-A / WP-U + LG-V + TH-S)	125 kg
Mounting plate (PM)	40 kg
Wall mount holders (UCH-2)	200 kg
Doors	7,5 kg

Maximal power dissipation

No.	Type	Description	Max. Δ P (W)
Serie 4XN160			
1	4XN160 2-3	Wall-mounted enclosure IP41 (IP42, IP44) empty	69,5
2	4XN160 2-4	Wall-mounted enclosure IP41 (IP42, IP44) empty	83
3	4XN160 2-5	Wall-mounted enclosure IP41 (IP42, IP44) empty	91,7
4	4XN160 2-6	Wall-mounted enclosure IP41 (IP42, IP44) empty	118,6
5	4XN160 2-7	Wall-mounted enclosure IP41 (IP42, IP44) empty	82,5
6	4XN160 3-3	Wall-mounted enclosure IP41 (IP42, IP44) empty	95,2
7	4XN160 3-4	Wall-mounted enclosure IP41 (IP42, IP44) empty	111,7
8	4XN160 3-5	Wall-mounted enclosure IP41 (IP42, IP44) empty	105,2
9	4XN160 3-6	Wall-mounted enclosure IP41 (IP42, IP44) empty	121,6
10	4XN160 3-7	Wall-mounted enclosure IP41 (IP42, IP44) empty	128,7
Serie 4XP160			
11	4XP160 2-3	Flush-mounted enclosure IP42 (IP44) empty	57,2
12	4XP160 2-4	Flush-mounted enclosure IP42 (IP44) empty	68,6
13	4XP160 2-5	Flush-mounted enclosure IP42 (IP44) empty	83,7
14	4XP160 2-6	Flush-mounted enclosure IP42 (IP44) empty	88,4
15	4XP160 2-7	Flush-mounted enclosure IP42 (IP44) empty	100,5
16	4XP160 3-3	Flush-mounted enclosure IP42 (IP44) empty	80,4
17	4XP160 3-4	Flush-mounted enclosure IP42 (IP44) empty	98,9
18	4XP160 3-5	Flush-mounted enclosure IP42 (IP44) empty	111,1
19	4XP160 3-6	Flush-mounted enclosure IP42 (IP44) empty	90
20	4XP160 3-7	Flush-mounted enclosure IP42 (IP44) empty	117,4



The advantages and technical characteristics

Wall-mounted enclosures 4XN160

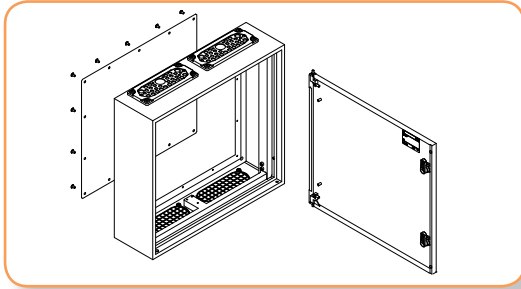

The wall-mounted enclosures consists of body with demountable back plates and non-perforated doors.

Wall-mounted enclosure set is equipped with:

- plugs of holes for wall-mounting
- earthing set - nuts, washers, labels, screws
- screws AS-SH 6x10 for fixing vertical brackets WP-A and WP-U
- cable membrane flanges – top
- plugs of flange holes – bottom
- doors with lock sets with keys - code 1333
- Allen key Hex5
- mounting instruction

Back plate of wall-mounted enclosure

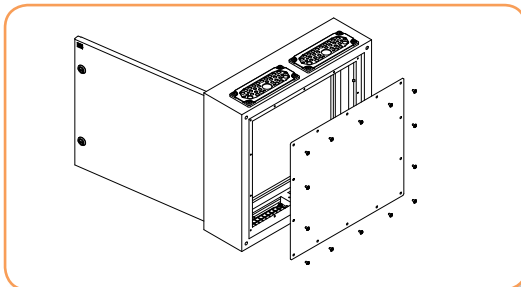

Back plate is made of zinc galvanized sheet steel fastened with sheet metal screws. After demounting of a back plate, there is a possibility of wiring of aparats with an included into enclosure insert.

Mounting wall-mounted enclosure directly to the wall.

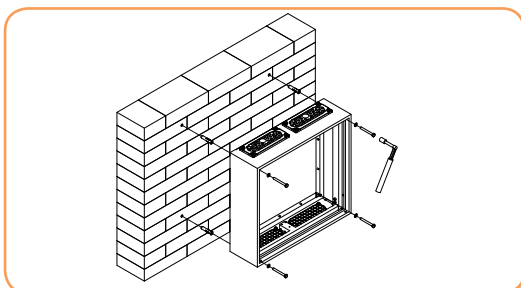

Direct mounting to the wall prevents the removal of the enclosure without opening the door.

Flush-mounted enclosures 4XP160

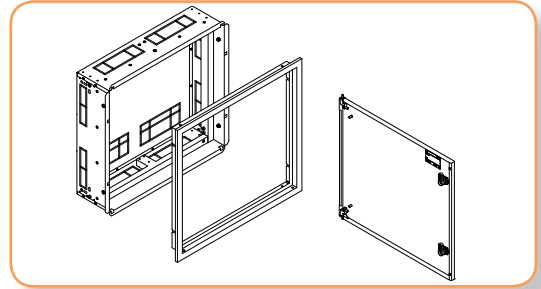

The flush-mounted enclosures consist of a cassette and demountable frame with non-perforated doors.

Flush-mounted enclosure is equipped with:

- earthing set - nuts, washers, labels, screws M6x10
- screws AS-SH 6x10 for fixing vertical brackets WP-A and WP-U
- screws M6x40 with locknuts for cassette positioning (placement)
- doors with frame, lock sets with keys - code 1333
- Allen key Hex5
- mounting instruction

Door mounting in enclosure

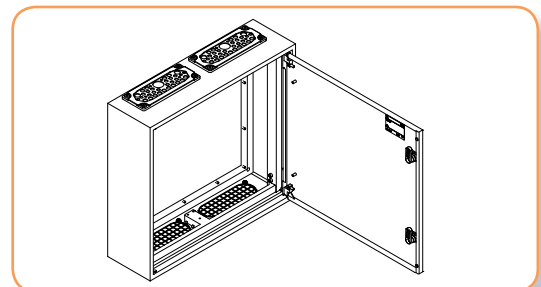

Special hinges - the door can be mounted without tools. The doors can be changed on the left or right, both at wall- and flush-mounted enclosures.

Mounting wall-mounted enclosure to the wall with holders UCH-2

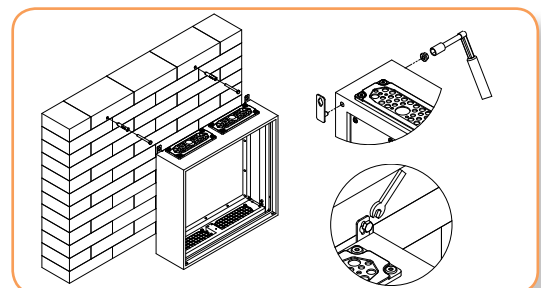

External holders makes the enclosure hanging easy.

Flush-mounting cassette

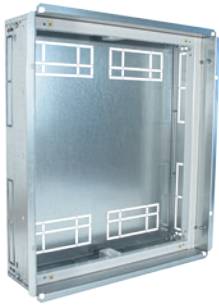

Made of 1 mm thick galvanized sheet steel. A very rigid structure.

It has weakness to cut holes through which the cables are placed.

The cassette has holes for fixing in the cavity.

M6x40 screws are supplied along complete with the cassette for positioning only.

Final fixing done by fixing bolts (in the cassette $\varnothing 9$ mm holes and bean holes 6 mm) and mounting foam (additional holes for the foam insert).

Cassette assembly in the cavity

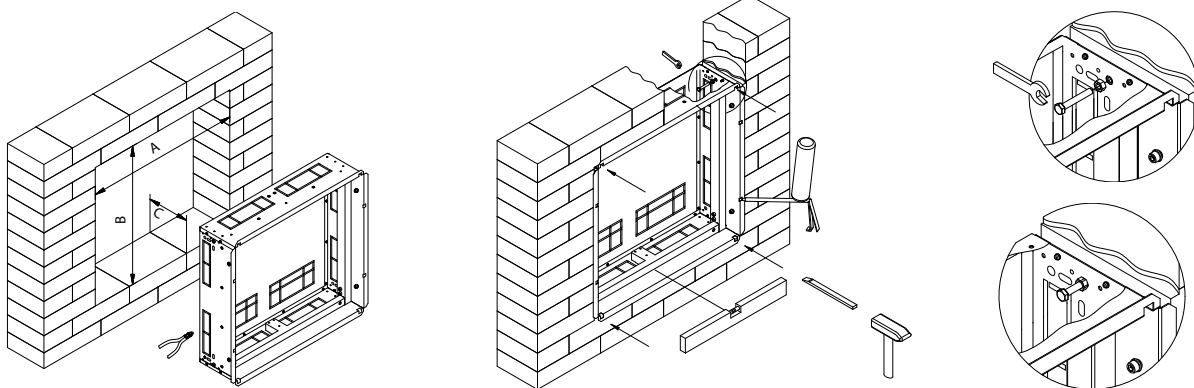

Suggested dimensions of the cavity are shown in the table on p. 19

Fixing the door frame

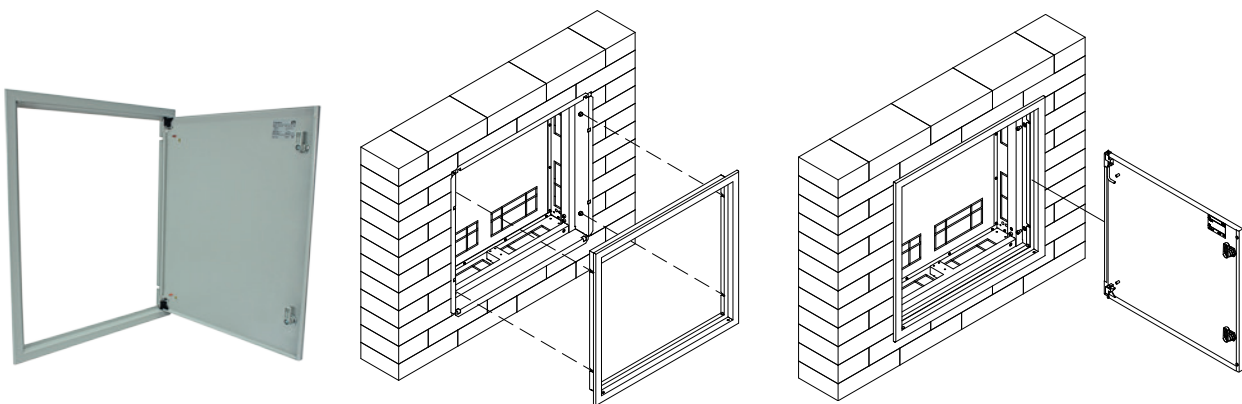

Door frame with door is screwed after the cassette assembly.

Fixing takes place with bolts, where you can adjust the vertical location approx. 20 mm. There is the possibility of a few percent adjustment from the plane of the door frame relative to the cassette back to compensate inaccuracies in work.

Doors can be open from left or right side.

Note! Frame with doors and cassette are sold in one set. (one code number)

Locks for doors



Enclosure doors are equipped as a standard with two patent locks key with code 1333 in light gray (RAL 7035). You can change the locks on any available in the ETI offer called LK... M22.

Holes for cable glands

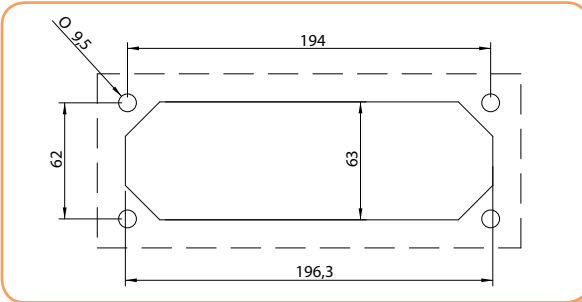

Wall-mounted enclosures have holes for cable glands (standard FL21). In the case of top standard cable glands are installed membrane EH-TKC-36, while at the bottom of the enclosure there are plastic plugs installed in the holes. In the case of approach leads from the bottom of the housing can rotate 180 degrees. The range includes steel and aluminum membrane glands.

Membrane gland



The use of modern glands allows the introduction of wires without single cable glands and without the use of special tools. Possible cable diameters: 4x(4-8 mm) + 4x(6-10 mm) + 12x(7-12 mm) + 14x(10-14 mm) + 2x(12-18 mm) + 1x(17-32 mm).

Steel/aluminium gland

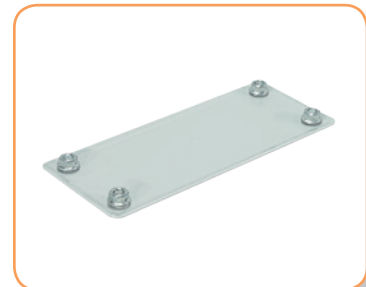

It allows to use cables and wires with larger cross-sections (appropriate cable glands).

Degree of protection IP



Wall-mounted enclosures 4XN160:

- without seals IP41
- with the seal back cover IP42
- with the seal back cover and door IP44

Flush-mounted enclosures 4XP160 (frame with a door):

- without door seal IP42
- with door seal IP44

Normally, without additional sealing, wall-mounted enclosures 4XN160 have a degree of protection IP41, while flush-mounted have IP42. Additional sealing of the back of wall-mounted and the door of flush-mounted is made by glue SEAL -G9. It is glued by the customer according to instruction.

Seal lengths are given in Tables (page 18).



For achieve proper degree of protection, space between door frame and the wall should be sealed by silicone sealant.

The length of the seals ensuring an appropriate level of IP protection

Wall-mounted enclosures		
Type	Total length of the seal (m) for IP 42	Total length of the seal (m) for IP 44
4XN160 2-3	1,8	3,8
4XN160 2-4	2,1	4,4
4XN160 2-5	2,4	5
4XN160 2-6	2,7	5,6
4XN160 2-7	3	6,2
4XN160 3-3	2,3	4,8
4XN160 3-4	2,6	5,4
4XN160 3-5	2,9	6
4XN160 3-6	3,2	6,6
4XN160 3-7	3,5	7,2

Flush-mounted enclosures	
Type	Total length of the seal (m) for IP 44
4XP160 2-3	2,2
4XP160 2-4	2,5
4XP160 2-5	2,8
4XP160 2-6	3,1
4XP160 2-7	3,4
4XP160 3-3	2,7
4XP160 3-4	3
4XP160 3-5	3,3
4XP160 3-6	3,6
4XP160 3-7	3,9

The earthing circuit

Metal enclosures 4XN160 / 4XP160 ensure the continuity of the protective electrical circuit connections through conductive metal parts of the housing. Additionally, M6 (8 pcs.) nuts are welded to the cassette and simultaneously they are used to fastening the vertical bracket (WP-A / HR-U) and to the connection the protective conductor.

External ground conductor can be connected to the main terminal installed by the switchgear manufacturer (main terminal PE, PE distribution block) or directly to the welded nuts M6 (screw DIN912 Type AS-SH 6x10 delivered complete with enclosure, torque 5 Nm). In the case of the external protective circuit is connected to the main terminals PE or PE distribution block it must be also connected to the welded M6 nuts.



If there is electrical equipment on the door LPE-6 wire must be used to connect the protective circuit with the door. For this purpose both the frame and door have welded copper-plated pins M6x12.

Enclosures are delivered to the customer without distribution blocks, PE protective terminals and neutral N.

Overview Heights/Widths- Internal dividing for enclosures 4XN160 and 4XP160

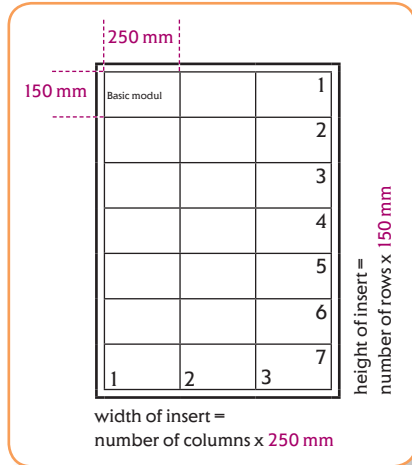

Range of sizes is based on DIN 43870 standard. Base module with devices cover has a width of 250 mm and a height of 150 mm. In this module you can install 12 modular devices with a width 18 mm. A code for the basic fields represent two digits separated by a dash of 1-1, where the first digit describes the width and the second height. Other sizes multiples the basic fields (eg. 2-3 cover mean- width 500 mm, height 450 mm). 4XN160 wall-mounted enclosures and 4XP160 flush-mounted occur in two window widths 2 and 3 (500 mm and 750 mm) and height 3, 4, 5, 6, 7 (450 mm, 600 mm, 750 mm, 900 mm, 1050 mm). Enclosures with width 2 can be divided in vertical configuration 1 + 1. In contrast, the width of the enclosure 3 can be divided in the configuration of 1 + 1 + 1, 2 + 1 or 1 + 2.

Naming method for 4XN160 and 4XP160 enclosures:

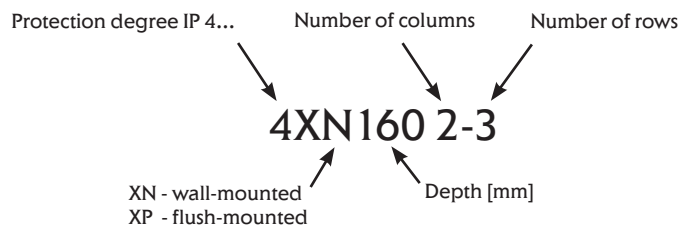

Enclosure types						External enclosure dimensions			Cavity suggested dimensions			
No.	Type	Description	Code no.	The maximum number of modules		Width (mm)	Height (mm)	Depth (mm)	Width (mm)	Height (mm)	Depth (mm)	Weight (kg)
Series 4XN160												
1	4XN160 2-3	Wall-mounted enclosure IP41 empty	001101400	3x24 mod.	72	550	500	160	-	-	-	9,67
2	4XN160 2-4	Wall-mounted enclosure IP41 empty	001101401	4x24 mod.	96	550	650	160	-	-	-	11,77
3	4XN160 2-5	Wall-mounted enclosure IP41 empty	001101402	5x24 mod.	120	550	800	160	-	-	-	13,87
4	4XN160 2-6	Wall-mounted enclosure IP41 empty	001101403	6x24 mod.	144	550	950	160	-	-	-	15,96
5	4XN160 2-7	Wall-mounted enclosure IP41 empty	001101404	7x24 mod.	168	550	1100	160	-	-	-	18,05
6	4XN160 3-3	Wall-mounted enclosure IP41 empty	001101405	3x36 mod.	108	800	500	160	-	-	-	12,91
7	4XN160 3-4	Wall-mounted enclosure IP41 empty	001101406	4x36 mod.	144	800	650	160	-	-	-	15,61
8	4XN160 3-5	Wall-mounted enclosure IP41 empty	001101407	5x36 mod.	180	800	800	160	-	-	-	18,30
9	4XN160 3-6	Wall-mounted enclosure IP41 empty	001101408	6x36 mod.	216	800	950	160	-	-	-	21,01
10	4XN160 3-7	Wall-mounted enclosure IP41 empty	001101409	7x36 mod.	252	800	1100	160	-	-	-	24,23
Series 4XP160												
11	4XP160 2-3	Flush-mounted enclosure IP42 empty	001101410	3x24 mod.	72	610	560	160	581	525	170	11,20
12	4XP160 2-4	Flush-mounted enclosure IP42 empty	001101411	4x24 mod.	96	610	710	160	581	675	170	13,51
13	4XP160 2-5	Flush-mounted enclosure IP42 empty	001101412	5x24 mod.	120	610	860	160	581	825	170	15,72
14	4XP160 2-6	Flush-mounted enclosure IP42 empty	001101413	6x24 mod.	144	610	1010	160	581	975	170	18,04
15	4XP160 2-7	Flush-mounted enclosure IP42 empty	001101414	7x24 mod.	168	610	1160	160	581	1125	170	20,30
16	4XP160 3-3	Flush-mounted enclosure IP42 empty	001101415	3x36 mod.	108	860	560	160	831	525	170	14,68
17	4XP160 3-4	Flush-mounted enclosure IP42 empty	001101416	4x36 mod.	144	860	710	160	831	675	170	17,56
18	4XP160 3-5	Flush-mounted enclosure IP42 empty	001101417	5x36 mod.	180	860	860	160	831	825	170	20,34
19	4XP160 3-6	Flush-mounted enclosure IP42 empty	001101418	6x36 mod.	216	860	1010	160	831	975	170	23,24
20	4XP160 3-7	Flush-mounted enclosure IP42 empty	001101419	7x36 mod.	252	860	1160	160	831	1125	170	26,63

INTERNAL STRUCTURAL SYSTEM AND ACCESSORIES

Components - Internal structural system and accessories

- Covers CP plain and modular
- Covers CP dedicated to ETI equipment
- Mounting plates PM
- Mounting rails TH-S
- Vertical brackets WP-A and WP-U
- Dividing element EPW
- Mounting elements LG-V and LG-V5
- Screws, nuts, washers
- Holders UW-GT and UCH-2
- Cable glands
- Pocket for documents, seals, pliers
- Locks
- Keys

Advantages:

- CP covers and PM mounting plates are dedicated to ETI devices (disconnectors, MCCB's modular equipment – perforated plates and covers are prepared to quick cut-outs the holes
- Quick and easy covers installation the use of special sealable clips
- CP covers earthing pins ensure protection against electric shock
- The possibility of vertically dividing the enclosure through EPW element. Insert is installed in very simple way
- Vertical brackets: WP-A enables the installation of equipment at various depths and WP-U without adjusting the depth and without the possibility of dividing the enclosure (economical version)
- Universal sheet metal screws for fixing brackets, mounting plates, rails TH
- Possibility of mounting rail TH at an angle
- Different Types of locks matching the entire system GSX
- Metal enclosures painted with polyester paint resistant to UV radiation

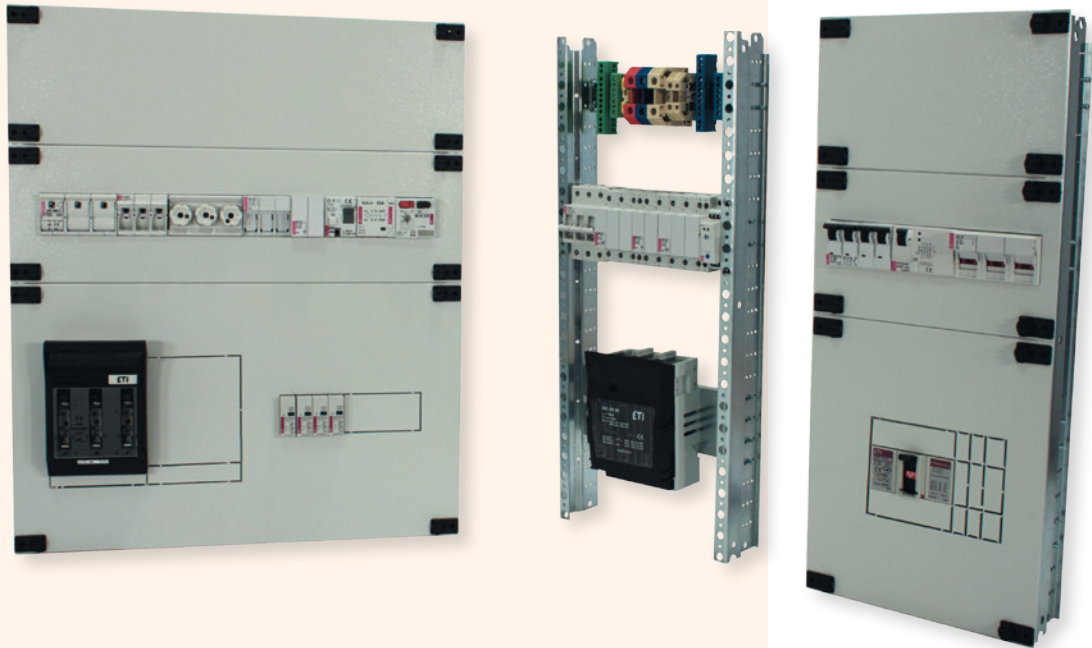

Vertical bracket WP-U



Vertical bracket economical version offers no possibility of the enclosure division and mounting depth TH-S rails adjustment as well as mounting plates PM. The same distance (48.5 mm) from rails TH-S to covers. Rails TH-S and plates PM are directly mounted to the bracket WP-U by means of sheet metal screws AST 4.8x9.5 without the use of fasteners LG-V. The brackets are attached to the enclosure with Allen screws M6x10 supplied along with the enclosure.

Brackets are packaged in sets of 2 pieces.

Vertical bracket WP-A

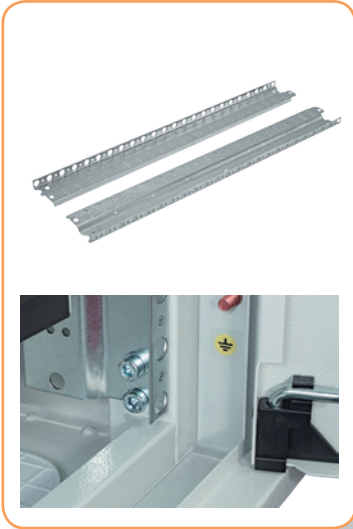

The special design of the vertical brackets WP-A enables the installation of equipment at various depths. Adjustment is possible due to the brackets perforation and elements LG-V, LG-V5. Mounting rails TH-S, and PM mounting plates are fixed to LG-V, LG-V5 elements. Plates and rails are screwed to the elements LG-V with metric screws. The design of the vertical bracket WP-A enables users to adjust mounting rails TH-S, mounting plates PM and covers CP. Vertical adjustment is made with step 25 mm, while the depth regulation for rails TH-S and mounting plates PM is 8 mm or alternately 6 mm or 2 mm (this is done by additional holes in the elements LG-V and LG-V5).

Slots in brackets to enable the choice of the distance between devices and covers.

On the bracket WP-A additional holes were applied to determine easy mounting position for rails TH-S and plates PM. Hole pitch is 150 mm and 75 mm.

The brackets are attached to the body with the supplied Allen hex screws M6x10 along with the enclosure.

Brackets are packaged in one set (left and right).

Mounting elements LG-V

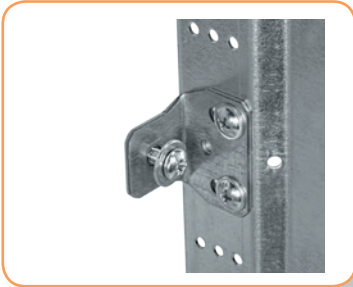

LG-V elements are used to fix the rails TH-S and mounting plates PM to vertical bracket WP-A. It is done with the help of two sheet metal screws (AST 4.8x9.5). The LG-V element contains a metric nut M5.

TH-S rails and mounting plates PM are attached to the element LG-V using metric screws M5 (AS-C 5x10) with washer (AW-RE5). LG-V element should be used for mounting rails TH-S designed for modular equipment, mounting plates PM H00 M (for disconnectors LTL00 / HVL00 and modular equipment), PM ... E12 M (for disconnectors ED2/circuit breakers EB2 125A, 160A, 250A and modular equipment), PM ... H00 (for disconnectors LTL00 / HVL00), mounting plates PM..E12 L12 (for disconnectors ED2/circuit breakers EB2 125A, 160A, 250A). Fixing one TH-S rail is made by 2 pieces of LG-V (1 x set LG-V SET). Fixing plates PM by means of 4 pieces LG-V (2 x set LG-V SET). Minimum distance from mounting plane to the cover is 57,5 mm, the maximum offset is 79,5 mm.

LG-V element are packed: 50 pieces as a single element without sheet metal screws, metric screws and washers or as a set (SET) containing 2 pieces of LG-V, 4 sheet metal screws, 2 washers and 2 metric screws M5.

Mounting elements LG-V5

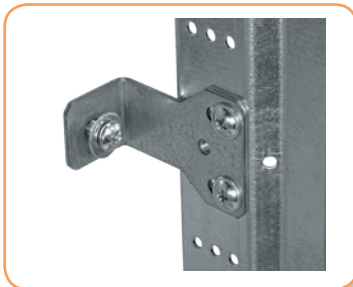

LG-V5 elements are used to fix the rails TH-S and mounting plates PM to vertical bracket WP-A. It is done with the help of two sheet metal screws (AST 4.8x9.5). The LG-V element contains a metric nut M5.

TH-S rails and mounting plates PM are attached to the element LG-V using metric screws M5 (AS-C 5x10) with washer (AW-RE5). LG-V5 element should be used for mounting rails TH-S with terminals, PM ... E12 L12 (position 1 for disconnectors LA1 and position 1 and 4 for disconnectors LA2). The items are shown in the mounting instructions CP X-2 L1 and CP X-2. Fixing one TH-S rail is made by 2 pieces of LG-V5 (1 x set LG-V5 SET), mounting plates PM by 4 pieces LG-V5 (2 x set LG-V5 SET). Minimum distance from mounting plane to the cover is 85 mm, the maximum offset is 107 mm.

LG-V5 element are packed: 20 pieces as a single element without sheet metal screws, metric screws and washers or as a set (SET) containing 2 pieces of LG-V5, 4 sheet metal screws, 2 washers and 2 metric screws M5.

Dividing set EPW

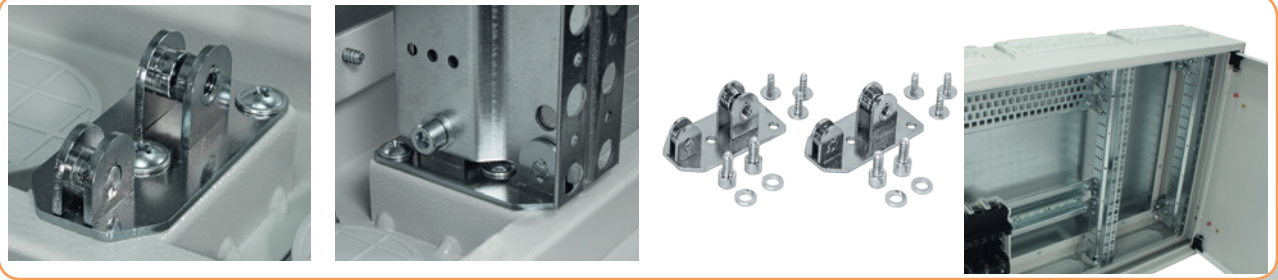

An important advantage of our system is the possibility to split enclosures vertically by means of a set of EPW and vertical bracket WP-A. This enables to create separate space for compartment cable or media.

It is not possible divide the enclosure with the vertical bracket WP-U (economical version without the possibility to adjust the depth of TH-S rails, plates PM and the possibility to dividing the enclosure into sections).

EPW dividing set contains: 2 pieces of dividing elements, 6 sheet metal screws, 4 x Allen screws M6x10 and 4 washers.

Sheet metal screw



An important element of the system is a special sheet metal screw AST 4.8x9.5 with Philips head PH2. If is used to fix elements LG-V / LG-V5 to the s WP-A, WP-U, TH-S rails, mounting plates PM, cable glands covers in GT enclosures, back plates in XN.. enclosures

DIN mounting rail TH-S

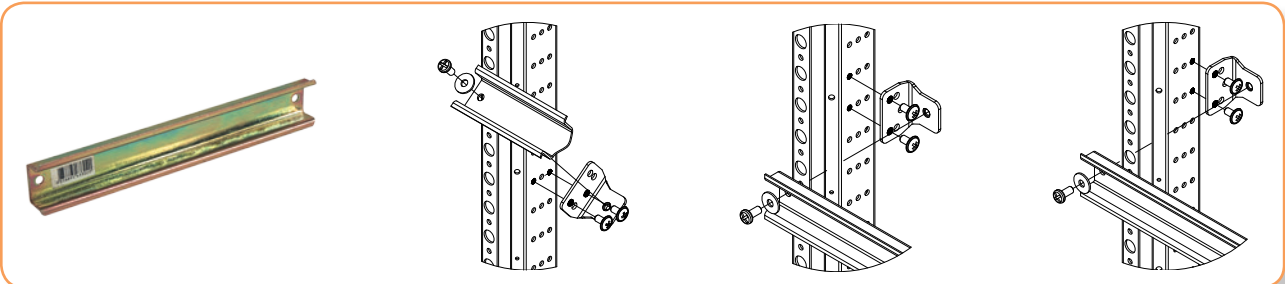

Rail TH-S can be mounted with different distances to the covers (for the LG-V : minimum distance rails to cover is 42.5 mm, the basic distance 48.5 mm, the maximum 64.5 mm; for the LG-V5 minimal distance is 70 mm, the basic 76 mm and maximum 92 mm).

Rails TH-S can also be mounted at an angle approx. 51 degrees to the vertical plain. This facilitates an approach to connect wires to the terminals mounted on the DIN rail.

CP covers

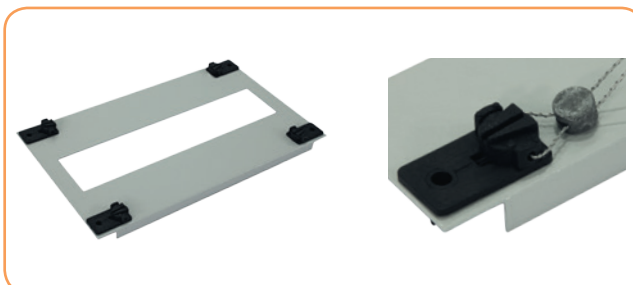

CP covers are made of powder-coated sheet steel. All covers are equipped with earthing pins (if any equipment is mounted on the covers or insulating gaps are less than shown in EN 61439-1 standard a cover grounding is recommended). CP covers are equipped with clips fastening in commercial set. Clips have the possibility of sealing. The special design of the clips allows easy and fast cover installation.

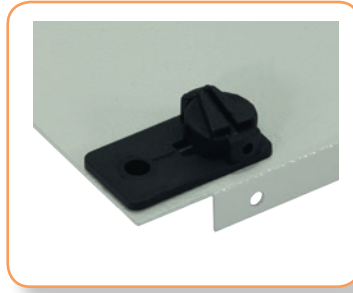
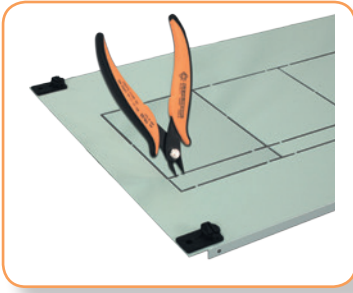

The offer includes plain covers, covers matching to 45 mm modular equipment, covers dedicated for MCCB's EB/ED, disconnectors with fuses LTL/HVL, switch disconnectors type LA and combined with an additional 45mm holes for modular equipment. Covers have a weakening to be cut to allow adaptation to the different sizes of units and configurations (different mounting depth, right and left). Covers dedicated to EB/ED, LTL/HVL, LA has to be assembled in a certain position. For easy recognition mounting position small hole is always located in the left bottom corner. Cut-outs in covers allow matching cover to the device (type, mounting place). For cut out elements from cover use the CP-PLIER pliers. Dedicated CP covers and appropriate PM mounting plates are available. Method of attachment devices, covers and mounting plates to the brackets is included in the respective mounting instructions supplied with CP covers.

Instructions are also available on the website.

Mounting plates PM

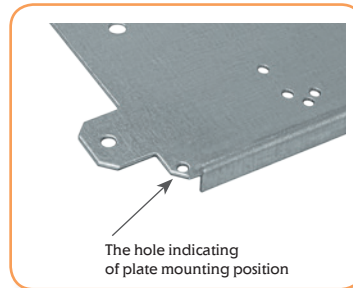
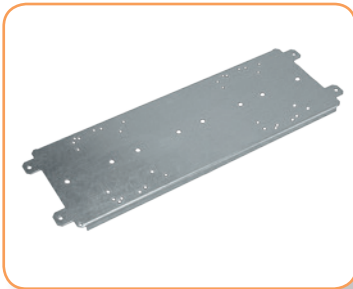

Mounting plates are made of galvanized sheet steel 1.5 mm to 3 mm. **Thick plates have drilled holes** for mounting ETI devices. The plates for disconnectors and circuit breakers EB / ED, LTL / HVL and modular equipment are equipped with mounting rail (height TH15 mm). Mounting plates as well as the covers have positioning holes always located in the left bottom corner. To improve stiffness of the plates edges are folded. For fixing electric apparatus to the mounting plate appropriate screws, nuts and washers should be purchased. Circuit breakers EB and disconnectors ED have included M4 screws (2 pcs version 3 service, 4 pieces 4 half) without nuts and washers securing. Mounting plates for WP-A brackets are fixed with 4 pieces of LG-V or LG-V5 elements. Method of attachment devices, covers and mounting plates to the vertical brackets is included in the respective assembly instructions supplied with CP covers.

Instructions are also available on the website.

SYSTEM ELEMENTS GSX
SOLID GSX
Plain covers (without cut-outs) - Height 50 mm

Type	Product name	Code no.	Weight (kg)	Packaging (pc.)
CP 1-0.33 F	Plain cover (250x50)	001101420	0,11	1
CP 1.4-0.33 F	Plain cover (350x50)	001101421	0,14	1
CP 2.2-0.33 F	Plain cover (550x50)	001101422	0,23	1
CP 3-0.33 F	Plain cover (750x50)	001101423	0,31	1
CP 3.8-0.33 F	Plain cover (950x50)	001101424	0,39	1

Mounting instructions: CP X-Y F

Plain covers (without cut-outs) - Height 75 mm

Type	Product name	Code no.	Weight (kg)	Packaging (pc.)
CP 1-0.5 F	Plain cover (250x75)	001101425	0,15	1
CP 2-0.5 F	Plain cover (500x75)	001101426	0,30	1
CP 3-0.5 F	Plain cover (750x75)	001101427	0,45	1

Mounting instructions: CP X-Y F

Plain covers (without cut-outs) - Height 150 mm

Type	Product name	Code no.	Weight (kg)	Packaging (pc.)
CP 1-1 F	Plain cover (250x150)	001101429	0,28	1
CP 1.4-1 F	Plain cover (350x150)	001101430	0,39	1
CP 2-1 F	Plain cover (500x150)	001101431	0,55	1
CP 2.2-1 F	Plain cover (550x150)	001101432	0,61	1
CP 3-1 F	Plain cover (750x150)	001101433	0,83	1
CP 3.8-1 F	Plain cover (950x150)	001101434	1,05	1

Mounting instructions: CP X-Y F

Plain covers (without cut-outs) - Height 300 mm

Type	Product name	Code no.	Weight (kg)	Packaging (pc.)
CP 1-2 F	Plain cover (250x300)	001101436	0,52	1
CP 1.4-2 F	Plain cover (350x300)	001101437	0,73	1
CP 2-2 F	Plain cover (500x300)	001101438	1,05	1
CP 2.2-2 F	Plain cover (550x300)	001101439	1,15	1
CP 3-2 F	Plain cover (750x300)	001101440	1,57	1
CP 3.8-2 F	Plain cover (950x300)	001101441	1,99	1

Mounting instructions: CP X-Y F

Plain covers (without cut-outs) - Height 450 mm

Type	Product name	Code no.	Weight (kg)	Packaging (pc.)
CP 1-3 F	Plain cover (250x450)	001101443	0,77	1
CP 2-3 F	Plain cover (500x450)	001101444	1,55	1
CP 3-3 F	Plain cover (750x450)	001101445	2,32	1

Mounting instructions: CP X-Y F

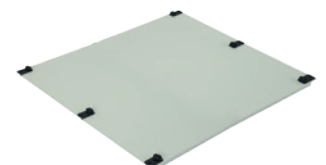
Covers

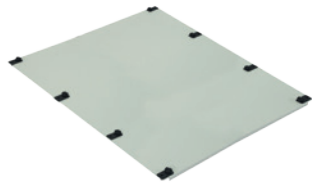

Plain covers (without cut-outs) - Height 600 mm

Type	Product name	Code no.	Weight (kg)	Packaging (pc.)
CP 1-4 F	Plain cover (250x600)	001101447	1,02	1
CP 2-4 F	Plain cover (500x600)	001101448	2,04	1
CP 3-4 F	Plain cover (750x600)	001101449	3,06	1

Mounting instructions: CP X-Y F



Modular covers 150 mm

Type	Product name	Code no.	Weight (kg)	Packaging (pc.)
CP 1-1 M	Modular cover 12 mod. (250x150)	001101451	0,21	1
CP 1.4-1 M	Modular cover 17 mod. (350x150)	001101452	0,29	1
CP 2-1 M	Modular cover 24 mod. (500x150)	001101453	0,42	1
CP 2.2-1 M	Modular cover 26 mod. (550x150)	001101454	0,46	1
CP 3-1 M	Modular cover 36 mod. (750x150)	001101455	0,63	1
CP 3.8-1 M	Modular cover 46 mod. (950x150)	001101456	0,79	1

Mounting instructions: CP X-1 M



Modular covers - Height 225 mm

Type	Product name	Code no.	Weight (kg)	Packaging (pc.)
CP 1-1.5 M	Modular cover 12 mod. (250x225)	001101458	0,33	1
CP 2-1.5 M	Modular cover 24 mod. (500x225)	001101459	0,67	1
CP 3-1.5 M	Modular cover 36 mod. (750x225)	001101460	1,00	1

Mounting instructions: CP X-1.5 M

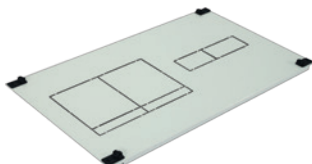

Covers for disconnectors HVL00/LTL00 and modular equipment - Height 300 mm

Type	Product name	Code no.	Weight (kg)	Packaging (pc.)
CP 1-2 H00 M	Cover 1xHVL00/LTL00 and 4 mod. (250x300)	001101474	0,52	1
CP 1.4-2 H00 M	Cover 1xHVL00/LTL00 and 5 mod. (350x300)	001101475	0,72	1
CP 2-2 H00 M	Cover 2xHVL00/LTL00 and 9 mod. (500x300)	001101476	1,03	1
CP 2.2-2 H00 M	Cover 2xHVL00/LTL00 and 10 mod. (550x300)	001101477	1,14	1
CP 3-2 H00 M	Cover 3xHVL00/LTL00 and 16 mod. (750x300)	001101478	1,55	1
CP 3.8-2 H00 M	Cover 4xHVL00/LTL00 and 21 mod. (950x300)	001101479	1,96	1

Cover must be completed with correspondent dedicated mounting plate: PM...H00 M

Mounting instructions: CP X-2 H00 M

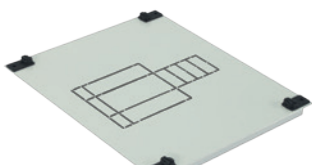

Covers for circuit breakers/disconnectors EB2/ED2 125,160,250 3P and modular equipment - Height 300 mm

Type	Product name	Code no.	Weight (kg)	Packaging (pc.)
CP 1-2 E12 M 3P	Cover 1xEB2/ED2 125,160,250A 3P and 4 mod. (250x300)	001101481	0,51	1

Cover must be completed with correspondent dedicated mounting plate: PM 1 E12 M 3P

Mounting instructions: CP 1-2 E12 M 3P

Covers for circuit breakers/disconnectors EB2/ED2 125,160,250 3,4P and modular equipment – Height 300 mm

Type	Product name	Code no.	Weight (kg)	Packaging (pc.)
CP 1.4-2 E12 M	Cover 1xEB2/ED2 125,160,250A 3,4P and 4 mod. (350x300)	001101482	0,72	1
CP 2-2 E12 M	Cover 1xEB2/ED2 125,160,250A 3,4P and 12 mod. (500x300)	001101483	1,03	1
CP 2.2-2 E12 M	Cover 1xEB2/ED2 125,160,250A 3,4P and 14 mod. (550x300)	001101484	1,13	1
CP 3-2 E12 M	Cover 1xEB2/ED2 125,160,250A 3,4P and 25 mod. (750x300)	001101485	1,54	1
CP 3.8-2 E12 M	Cover 1xEB2/ED2 125,160,250A 3,4P and 36 mod. (950x300)	001101486	1,95	1

Cover must be completed with correspondent dedicated mounting plate: PM...E12 M
 Mounting instruction: CP X-2 E12 M

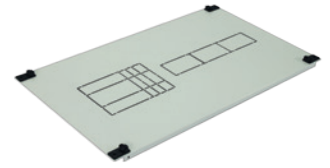

Covers for disconnectors HVL00/LTL00 – Height 300 mm

Type	Product name	Code no.	Weight (kg)	Packaging (pc.)
CP 1-2 H00	Cover 1xHVL00/LTL00 (250x300)	001101488	0,52	1
CP 1.4-2 H00	Cover 2xHVL00/LTL00 (350x300)	001101489	0,72	1
CP 2-2 H00	Cover 4xHVL00/LTL00 (500x300)	001101490	1,03	1
CP 2.2-2 H00	Cover 4xHVL00/LTL00 (550x300)	001101491	1,13	1
CP 3-2 H00	Cover 6xHVL00/LTL00 (750x300)	001101492	1,55	1
CP 3.8-2 H00	Cover 8xHVL00/LTL00 (950x300)	001101493	1,96	1

Cover must be completed with correspondent dedicated mounting plate: PM...H00
 Mounting instruction: CP X-2 H00

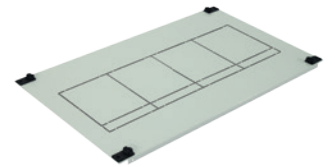

Covers for circuit breakers /disconnectors EB2/ED2 125,160,250 3,4P – Height 300 mm

Type	Product name	Code no.	Weight (kg)	Packaging (pc.)
CP 1-2 E12	Cover 1xEB2/ED2 125,160,250A 3,4P (250x300)	001101514	0,51	1
CP 1.4-2 E12	Cover 1xEB2/ED2 125,160,250A 3,4P (350x300)	001101515	0,72	1
CP 2-2 E12	Cover 2xEB2/ED2 125,160,250A 3,4P (500x300)	001101516	1,02	1
CP 2.2-2 E12	Cover 2xEB2/ED2 125,160,250A 3,4P (550x300)	001101517	1,13	1
CP 3-2 E12	Cover 3xEB2/ED2 125,160,250A 3,4P (750x300)	001101518	1,53	1
CP 3.8-2 E12	Cover 3xEB2/ED2 125,160,250A 3,4P (950x300)	001101519	1,95	1

Cover must be completed with correspondent dedicated mounting plate: PM...E12 L12
 Mounting instruction: CP X-2 E12

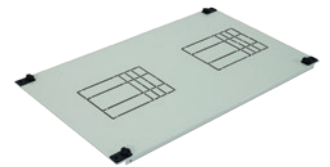

Covers for disconnectors LA1 – Height 300 mm

Type	Product name	Code no.	Weight (kg)	Packaging (pc.)
CP 1-2 L1	Cover 1xLA1 (250x300)	001101527	0,52	1
CP 1.4-2 L1	Cover 1xLA1 (350x300)	001101528	0,73	1
CP 2-2 L1	Cover 2xLA1 (500x300)	001101529	1,04	1
CP 2.2-2 L1	Cover 2xLA1 (550x300)	001101530	1,14	1
CP 3-2 L1	Cover 3xLA1 (750x300)	001101531	1,56	1
CP 3.8-2 L1	Cover 3xLA1 (950x300)	001101532	1,98	1

Cover must be completed with correspondent dedicated mounting plate: PM...E12 L12
 Mounting instruction: CP X-2 L1





Covers for disconnectors LA2- Height 300 mm

Type	Product name	Code no.	Weight (kg)	Packaging (pc.)
CP 1-2 L2	Cover 1xLA2 (250x300)	001101534	0,52	1
CP 1.4-2 L2	Cover 1xLA2 (350x300)	001101535	0,73	1
CP 2-2 L2	Cover 2xLA2 (500x300)	001101536	1,04	1
CP 2.2-2 L2	Cover 2xLA2 (550x300)	001101537	1,14	1
CP 3-2 L2	Cover 3xLA2 (750x300)	001101538	1,56	1
CP 3.8-2 L2	Cover 3xLA2 (950x300)	001101539	1,98	1

Cover must be completed with correspondent dedicated mounting plate: PM... E12 L12

Mounting instructions: CP X-2 L2

Mounting plates and DIN rails TH-S

To fix the mounting plate PM ... H00 M, PM ... E12 M, PM ... H00, L12 E12 PM ..., PM ... PER-A to the vertical bracket WP-A it is necessary to buy 2 mounting sets LG-V SET- code number 001101683 or purchase separately individual elements according to the statement in the following table:

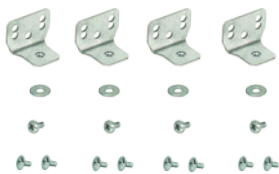

Type	Product name	Quantity (pcs.)
LG-V	Fixing element with a nut M5	4
AST 4.8x9.5	Sheet metal screw Philips head PH2	8
AW-RE 5	Plain washer (extended)	4
AS-C 5x10	Metric screw Philips head PH2	4

To fix the mounting rail TH-S to the vertical bracket WP-A it is necessary to buy 1 mounting set LG-V SET- code number 001101683 or purchase separately individual elements according to the statement in the following table. To fix the mounting rail TH-S to the vertical support WP-U use 2 pcs. sheets metal screw AST 4.8x9.5



Type	Product name	Quantity (pcs.)
LG-V	Fixing element with a nut M5	2
AST 4.8x9.5	Sheet steel metal screw Philips head PH2	4
AW-RE 5	Plain washer (extended)	2
AS-C 5x10	Metric screw Philips head PH2	2

Mounting plates for disconnectors HVL00/LTL00 and modular equipment

Type	Product name	Code no.	Weight (kg)	Packaging (pc.)
PM 1 H00 M	Mounting plate 1xHVL00/LTL00 with DIN rail for 4 mod. (250)	001101563	0,31	1
PM 1.4 H00 M	Mounting plate 1xHVL00/LTL00 with DIN rail for 5 mod. (350)	001101564	0,53	1
PM 2 H00 M	Mounting plate 2xHVL00/LTL00 with DIN rail for 9 mod. (500)	001101565	0,79	1
PM 2.2 H00 M	Mounting plate 2xHVL00/LTL00 with DIN rail for 10 mod. (550)	001101566	0,88	1
PM 3 H00 M	Mounting plate 3xHVL00/LTL00 with DIN rail for 16 mod. (750)	001101567	1,31	1
PM 3.8 H00 M	Mounting plate 4xHVL00/LTL00 with DIN rail for 21 mod. (950)	001101568	1,57	1

To fix on the mounting plate one piece of disconnector HVL00/LTL00 should be purchased:

- screw M6x16 DIN 933 (AS-H 6x16) - 2 pcs.
- plain washer M6 DIN126 (AW-R 6) - 4 pcs.
- spring washer M6 DIN127 (AW-S 6) - 2 pcs.
- nut M6 DIN934 (AN-H 6) - 2 pcs.

Mounting instruction : CP X-2 H00 M



Mounting plate for circuit breakers/disconnectors EB2/ED2 125,160,250 3P and modular equipment

Type	Product name	Code no.	Weight (kg)	Packaging (pc.)
PM 1 E12 M 3P	Mounting plate 1xEB2/ED2 3P with DIN rail for 4 mod. (250)	001101570	0,43	1

For fixing on the mounting plate one piece circuit breaker/disconnector EB2/ED2 with 3P version, should be purchased:

- plain washer M4 DIN126 (AW-R 4) - 2 pcs.
- spring washer M4 DIN127 (AW-S 4)-2 pcs.
- nut M4 DIN934 (AN-H 4) - 2 pcs.

Fixing screws in set with devices.

Mounting instruction: CP 1-2 E12 M 3P

**Mounting plate for circuit breakers/disconnectors EB2 /ED2 125,160,250 3P, 4P and modular equipment**

Type	Product name	Code no.	Weight (kg)	Packaging (pc.)
PM 1.4 E12 M	Mounting plate 1xEB2/ED2 with DIN rail for 4 mod. (350)	001101571	0,68	1
PM 2 E12 M	Mounting plate 1xEB2/ED2 with DIN rail for 12 mod. (500)	001101572	0,94	1
PM 2.2 E12 M	Mounting plate 1xEB2/ED2 with DIN rail for 14 mod. (550)	001101573	1,03	1
PM 3 E12 M	Mounting plate 1xEB2/ED2 with DIN rail for 25 mod. (750)	001101574	1,36	1
PM 3.8 E12 M	Mounting plate 1xEB2/ED2 with DIN rail for 36 mod. (950)	001101575	1,70	1

For fixing on the plate one piece circuit breaker/disconnector EB2/ED2 should be purchased:
version 3P

- plain washer M4 DIN126 (AW-R 4) - 2 pcs.
- spring washer M4 DIN127 (AW-S 4) - 2 pcs.
- nut M4 DIN934 (AN-H 4) - 2 pcs.

version 4P

- plain washer M4 DIN126 (AW-R 4) - 4 pcs.
- spring washer M4 DIN127 (AW-S 4) - 4 pcs.
- nut M4 DIN934 (AN-H 4) - 4 pcs.

Mounting instruction: CP X-2 E12 M

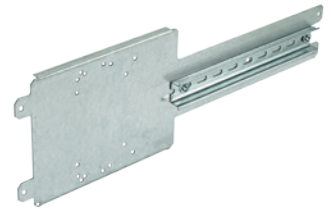
**Mounting plates for disconnectors HVL00/LTL00**

Type	Product name	Code no.	Weight (kg)	Packaging (pc.)
PM 1 H00	Mounting plate 1xHVL00/LTL00 (250)	001101577	0,32	1
PM 1.4 H00	Mounting plate 2xHVL00/LTL00 (350)	001101578	0,46	1
PM 2 H00	Mounting plate 4xHVL00/LTL00 (500)	001101579	0,70	1
PM 2.2 H00	Mounting plate 4xHVL00/LTL00 (550)	001101580	0,78	1
PM 3 H00	Mounting plate 6xHVL00/LTL00 (750)	001101581	1,08	1
PM 3.8 H00	Mounting plate 8xHVL00/LTL00 (950)	001101582	1,39	1

For fixing on the plate one piece of disconnector HVL00/LTL00 should be purchased:

- screw M6x16 DIN 933 (AS-H 6x16) - 2 pcs.
- plain washer M6 DIN126 (AW-R 6) - 4 pcs.
- spring washer M6 DIN127 (AW-S 6)-2pcs.
- nut M6 DIN934 (AN-H 6) - 2 pcs.

Mounting instruction: CP X-2 H00





Mounting plate for circuit breakers/disconnectors EB2/ED2 125,160,250 3, 4P and LA1, LA2

Type	Product name	Code no.	Weight (kg)	Packaging (pc.)
PM 1 E12 L12	Mounting plate 1xEB2/ED2 125,160,250A 3,4P or 1xLA1,2 (250)	001101584	0,490	1
PM 1.4 E12 L12	Mounting plate 1xEB2/ED2 125,160,250A 3,4P or 1xLA1,2 (350)	001101585	0,757	1
PM 2 E12 L12	Mounting plate 2xEB2/ED2 125,160,250A 3,4P or 2xLA1,2 (500)	001101586	1,153	1
PM 2.2 E12 L12	Mounting plate 2xEB2/ED2 125,160,250A 3,4P or 2xLA1,2 (550)	001101587	1,287	1
PM 3 E12 L12	Mounting plate 3xEB2/ED2 125,160,250A 3,4P or 3xLA1,2 (750)	001101588	1,818	1
PM 3.8 E12 L12	Mounting plate 3xEB2/ED2 125,160,250A 3,4P or 3xLA1,2 (950)	001101589	2,352	1

For fixing on the plate one piece circuit breaker/disconnector EB2/ED2 should be purchased :
version 3P

- plain washer M4 DIN126 (AW-R 4) - 2 pcs.
- spring washer M4 DIN127 (AW-S 4) - 2 pcs.
- nut M4 DIN934 (AN-H 4) W - 2 pcs.

version 4P

- plain washer M4 DIN126 (AW-R 4) - 4 pcs.
- spring washer M4 DIN127 (AW-S 4) - 4 pcs.
- nut M4 DIN934 (AN-H 4) - 4 pcs.

Fixing screws in set with devices..

Mounting instruction: CP X-2 E12

For attaching one piece LA1 should be purchased:

- screw M4x16 DIN7985 (AS-C 4x16) - 4 pcs.
- plain washer M4 DIN126 (AW-R 4) - 4 pcs.
- spring washer M4 DIN127 (AW-S 4) - 8 pcs.
- nut M4 DIN934 (AN-H 4) - 4 pcs.

Mounting instruction: CP X-2 L1

For fixing one piece LA2 should be purchased:

- screw M4x20 DIN7985 (AS-C 4x20) - 4 pcs.
- plain washer M4 DIN126 (AW-R 4) - 4 pcs.
- spring washer M4 DIN127 (AW-S 4) - 8 pcs.
- nut M4 DIN934 (AN-H 4) - 8 pcs.

Mounting instruction: CP X-2 L2

Perforated mounting plates

Type	Product name	Code no.	Weight (kg)	Packaging (pc.)
PM 1-1 PER-A	Perforated mounting plate Type A (250)	001101620	0,17	1
PM 1-2 PER-A	Perforated mounting plate Type A (250)	001101621	0,48	1
PM 1-3 PER-A	Perforated mounting plate Type A (250)	001101622	0,76	1
PM 1-4 PER-A	Perforated mounting plate Type A (250)	001101623	1,04	1
PM 2-1 PER-A	Perforated mounting plate Type A (500)	001101624	0,38	1
PM 2-2 PER-A	Perforated mounting plate Type A (500)	001101625	0,97	1
PM 2-3 PER-A	Perforated mounting plate Type A (500)	001101626	1,51	1
PM 2-4 PER-A	Perforated mounting plate Type A (500)	001101627	2,05	1
PM 3-1 PER-A	Perforated mounting plate Type A (750)	001101628	0,57	1
PM 3-2 PER-A	Perforated mounting plate Type A (750)	001101629	1,48	1
PM 3-3 PER-A	Perforated mounting plate Type A (750)	001101630	2,29	1
PM 3-4 PER-A	Perforated mounting plate Type A (750)	001101631	3,10	1

Perforation - square holes 9,5 mm x 9,5 mm

Mounting instruction: PM X-Y PER-A

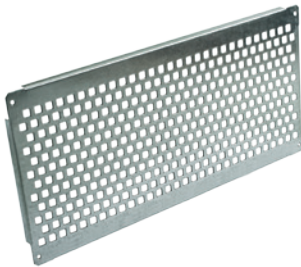

Mounting DIN rails TH-S

Type	Product name	Code no.	Weight (kg)	Packaging (pc.)
TH-S 1	Mounting rail 35/15 1.5 steel 215mm (250)	002911040	0,15	1
TH-S 1.4	Mounting rail 35/15 1.5 steel 315mm (350)	002911041	0,21	1
TH-S 2	Mounting rail 35/15 1.5 steel 465mm (500)	002911042	0,32	1
TH-S 2.2	Mounting rail 35/15 1.5 steel 515mm (550)	002911043	0,35	1
TH-S 3	Mounting rail 35/15 1.5 steel 715mm (750)	002911044	0,49	1
TH-S 3.8	Mounting rail 35/15 1.5 steel 915mm 950)	002911045	0,62	1

Selection the length of the rail depends on the mounting insert (removable or fixed) width.

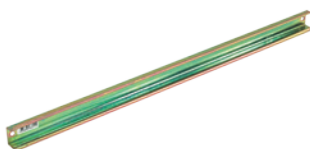

Vertical brackets WP-A

Type	Product name	Code no.	Weight (kg)	Packaging (pc.)
WP-A 2.33	3 position vertical bracket Type A (350) (1set=left and right)	001101716	0,68	1
WP-A 3	3 position vertical bracket Type A (450) (1set=left and right)	001101644	0,89	1
WP-A 3.66	3 position vertical bracket Type A (550) (1set=left and right)	001101645	1,09	1
WP-A 4	3 position vertical bracket Type A (600) (1set=left and right)	001101646	1,2	1
WP-A 5	3 position vertical bracket Type A (750) (1set=left and right)	001101647	1,51	1
WP-A 6	3 position vertical bracket Type A (900) (1set=left and right)	001101648	1,82	1
WP-A 6.33	3 position vertical bracket Type A (950) (1set=left and right)	001101649	1,92	1
WP-A 7	3 position vertical bracket Type A (1050) (1set=left and right)	001101650	2,13	1
WP-A 7.66	3 position vertical bracket Type A (1150) (1set=left and right)	001101651	2,34	1

Mounting instruction: WP-A

Selection of vertical bracket depends on the height of the enclosure.

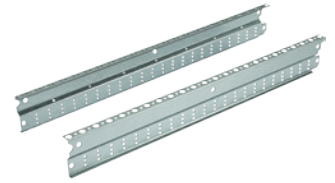
Vertical brackets WP-U

Type	Product name	Code no.	Weight (kg)	Packaging (pc.)
WP-U 2.33	1 position vertical bracket Type U (350) (1set = 2pcs.)	001101717	0,81	1
WP-U 3	1 position vertical bracket Type U (450) (1set = 2pcs.)	001101666	1,06	1
WP-U 3.66	1 position vertical bracket Type U (550) (1set = 2pcs.)	001101667	1,30	1
WP-U 4	1 position vertical bracket Type U (600) (1set = 2pcs.)	001101668	1,42	1
WP-U 5	1 position vertical bracket Type U (750) (1set = 2pcs.)	001101669	1,78	1
WP-U 6	1 position vertical bracket Type U (900) (1set = 2pcs.)	001101670	2,15	1
WP-U 6.33	1 position vertical bracket Type U (950) (1set = 2pcs.)	001101671	2,27	1
WP-U 7	1 position vertical bracket Type U (1050) (1set = 2pcs.)	001101672	2,51	1
WP-U 7.66	1 position vertical bracket Type U (1150) (1set = 2pcs.)	001101673	2,75	1

Mounting instruction: WP-U

Selection of vertical bracket depends on the height of the enclosure.

Dividing element EPW (set)

Type	Product name	Code no.	Weight (kg)	Packaging (pc.)
EPW	Enclosure dividing element (1set=2pcs.)	001101677	0,11	1

Mounting instruction: EPW

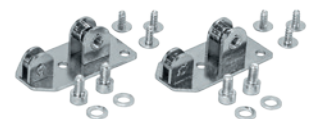



Fixing element with a nut M5				
Type	Product name	Code no.	Weight (kg)	Packaging (pc.)
LG-V	Fixing element with a nut M5	001101679	0,03	50



Fixing element with a nut M5 type V5				
Type	Product name	Code no.	Weight (kg)	Packaging (pc.)
LG-V5	Fixing element with a nut M5 type V5	001101681	0,04	20



Fixing set with a nut M5 (1set=2pcs.)				
Type	Product name	Code no.	Weight (kg)	Packaging (pc.)
LG-V SET	Fixing set with a nut M5 (1kpl.=2szt.)	001101683	0,07	1

Mounting instruction: LG-V SET



Fixing set with a nut M5 type V5 (1set=2pcs.)				
Type	Product name	Code no.	Weight (kg)	Packaging (pc.)
LG-V5 SET	Fixing set with a nut M5 type V5 (1set=2pcs.)	001101685	0,09	1

Mounting instruction: LG-V5 SET

Note: Code numbers of screws, nuts and washers concern sets no single elements. Price in price list is for 1 set.



Sheet metal cross head screw PH2				
Type	Product name	Code no.	Weight (kg)	Packaging (pc.)
AST 4.8x9.5 SET	Sheet steel metal screw cross head PH2 (1set=200pcs.)	001101686	0,4	1



Metric screw - cross head PH2 DIN7985				
Type	Product name	Code no.	Weight (kg)	Packaging (pc.)
AS-C 4x16 SET	Metric screw - cross head PH2 DIN7985 (1set=10pcs.)	001101687	0,02	1
AS-C 4x20 SET	Metric screw - cross head PH2 DIN7985 (1set=10pcs.)	001101688	0,03	1



Metric screw - cross head PH2 DIN7985				
Type	Product name	Code no.	Weight (kg)	Packaging (pc.)
AS-C 5x10 SET	Metric screw - cross head PH2 DIN7985 (1set=100pcs.)	001101689	0,30	1



Metric screw M6-hex socked head DIN933				
Type	Product name	Code no.	Weight (kg)	Packaging (pc.)
AS-H 6x16 SET	Metric screw M6-hex socked head DIN933 (1set=10pcs.)	001101690	0,65	1



Extended washer DIN9021				
Type	Product name	Code no.	Weight (kg)	Packaging (pc.)
AW-RE 5 SET	Washer d=5,3 D=15 extended DIN9021 (1set=100pcs.)	001101692	0,15	1

Round plain washers DIN126

Type	Product name	Code no.	Weight (kg)	Packaging (pc.)
AW-R 4 SET	Round plain washers DIN126 d=4,3 D=10 DIN126 (1set=10pcs.)	001101693	0,01	1
AW-R 6 SET	Round plain washers d=6,6 D=12 DIN126 (1set=10pcs.)	001101694	0,01	1

Spring washers DIN127

Type	Product name	Code no.	Weight (kg)	Packaging (pc.)
AW-S 4 SET	Spring washer d=4,1 D=6,88 DIN127 (1set=10pcs.)	001101696	0,01	1
AW-S 6 SET	Spring washer d=6,1 D=9,78 DIN127 (1set=10pcs.)	001101698	0,01	1

Nuts DIN934

Type	Product name	Code no.	Weight (kg)	Packaging (pc.)
AN-H 4 SET	Nuts M4 DIN934 (1set=10pcs.)	001101700	0,01	1
AN-H 6 SET	Nuts M6 DIN934 (1set=10pcs.)	001101702	0,02	1

Holders for mounting plate for GT enclosures

Type	Product name	Code no.	Weight (kg)	Packaging (pc.)
UW-GT 150	Holders for mounting plate GT depth 150mm (1kpl.=4szt.)	001101705	0,49	1
UW-GT 200	Holders for mounting plate GT depth 200mm (1kpl.=4szt.)	001101706	0,58	1
UW-GT 250	Holders for mounting plate GT depth 250mm (1kpl.=4szt.)	001101707	0,67	1
UW-GT 300	Holders for mounting plate GT depth 300mm (1kpl.=4szt.)	001101708	0,82	1
UW-GT 400	Holders for mounting plate GT depth 400mm (1kpl.=4szt.)	001101709	1,05	1

1 set contains: 4 x holders + 6 x plain washers + 8 x hex socketed screws M6x10 + 2 x screws M5x10 + 2 x nuts M5

Mounting instruction: UW-GT

Selection of holder depending on the depth of the GT enclosure

Cable flanges with pins

Type	Product name	Code no.	Weight (kg)	Packaging (pc.)
EH-TKC-36	Cable flanges with pins (1set)	001101711	0,19	1

1 set contains: 1 x cable flange + 4 x pin

Mounting instruction: EH-TKC-36

Steel cable gland

Type	Product name	Code no.	Weight (kg)	Packaging (pc.)
EH-ST	Steel cable gland	001101712	0,24	1

1 set contains: 1 x steel cable gland + 4 x nut M8

Mounting instruction: EH

Aluminium cable gland

Type	Product name	Code no.	Weight (kg)	Packaging (pc.)
EH-AL	Aluminium cable gland	001101713	0,16	1

1 set contains: 1 x Aluminium cable gland + 4 x nut M8

Mounting instruction: EH

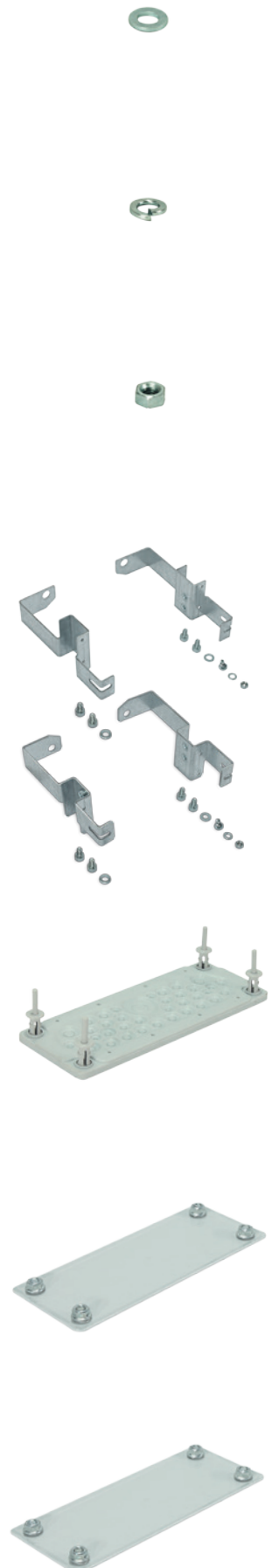



Key Lock				
Type	Product name	Code no.	Weight (kg)	Packaging (pc.)
LK-1333-M22 RAL 7035	Key Lock	001101718	0,15	1



Handle for enclosure hanging				
Type	Product name	Code no.	Weight (kg)	Packaging (pc.)
UCH-2	Handle for enclosure hanging (1set=2pcs.)	001101715	0,06	1

1 set contains: 2 x handle + 2 x nut M8
Mounting instruction: UCH-2



Seal				
Type	Product name	Code no.	Weight (kg)	Packaging (pc.)
SEAL-G9	Adhesive seal -10 meters (1set=10m)	001101608	0,09	1



Paint repair RAL7035				
Type	Product name	Code no.	Weight (kg)	Packaging (pc.)
FA-RAL7035	Paint repair RAL7035 (200 ml)	001101710	0,23	1



Pliers for cut-out in CP covers				
Type	Product name	Code no.	Weight (kg)	Packaging (pc.)
CP-PLIER	Pliers for CP covers	001101714	0,07	1

Examples of the enclosure configuration with mounting inserts

Example 1. 4XP160 2-4 enclosure with insert ready to install modular equipment.

Flush-mounted 4XP160 enclosure with IP42 degree of protection (it is possible to increase to IP44 by correct sealing SEAL-G9) with a width of 610 mm, 710 mm, 160 mm depth. Enclosure suitable for mounting modular devices with total 96 moduls. The applied support WP-U is an economical without possibility to TH-S at depth change, and without the ability to divide cabinet vertically. Please note that the sheet metal screw fixing rails needed for TH-S and mounting plates PM are sold in 200 units set. There are 8 pieces of sheet metal screws needed.

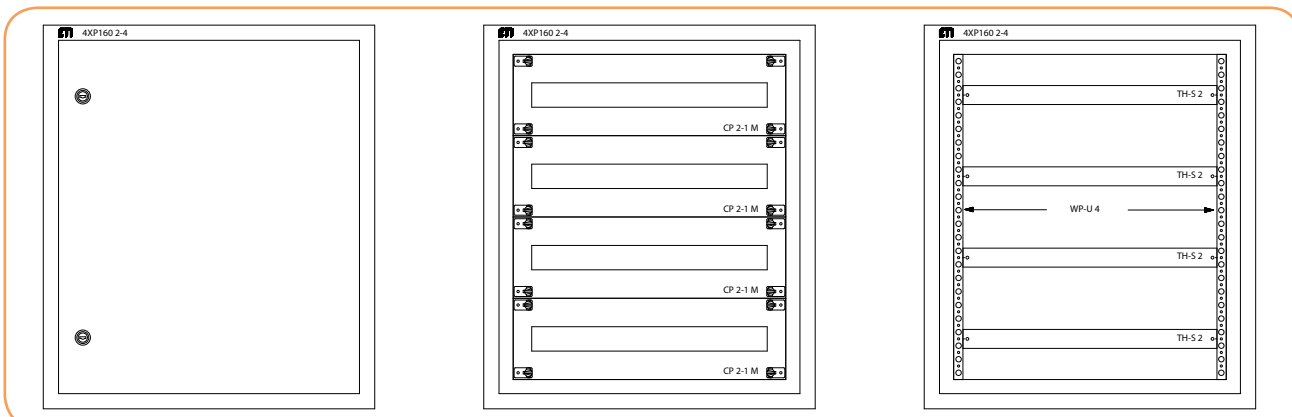

List of materials for 4XP160 2-4 enclosure with spare cost insert for modular equipment

No.	Type	Product name	Code no.	Quantity to be ordered
1	4XP160 2-4	Flush-mounted enclosure, IP42, kl. and RAL7035 (610x710x160)	001101411	1
2	WP-U 4	1 position vertical bracket Type U (600) (1set=2pcs.)	001101668	1
3	CP 2-1 M	Modular cover 24 mod. (500x150)	001101453	4
4	TH-S 2	Mounting rail 35/15 1.5 steel 465mm (500)	002911042	4
5	AST 4.8x9.5 SET	Sheet steel metal screw cross head PH2 (1set=200pcs.)	001101686	1

Example 2. Wall-mounted enclosure 4XN160 2-6 with insert ready to install modular equipment.

Wall-mounted enclosure 4XN160 with IP41 degree of protection (it is possible to increase the degree of protection to IP44 by correct sealing SEAL-G9) with a width of 550 mm, 950 mm, 160 mm depth. An enclosure suitable for mounting modular devices with total 144 moduls. The use of vertical bracket WP-A allows to adjust to the depth of rails.

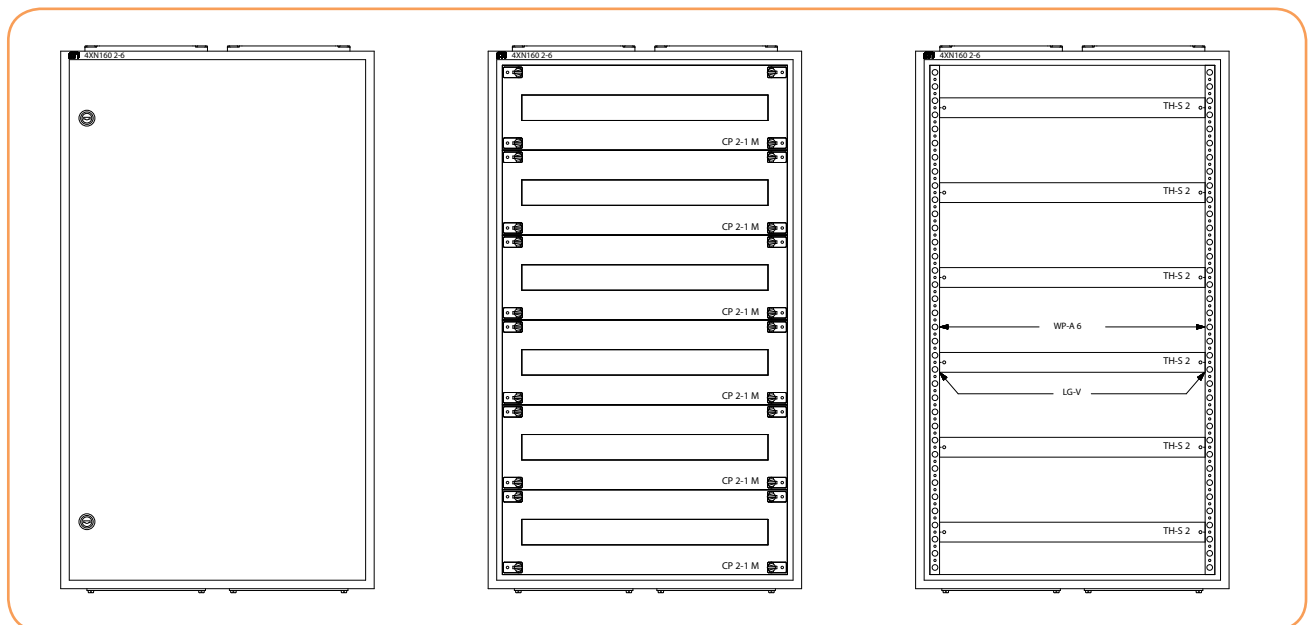
List of materials for 4XP160 2-6 enclosure with insert and modular equipment

No.	Type	Product name	Code no.	Quantity to be ordered
1	4XN160 2-6	Wall-mounted enclosure - empty, IP41, kl. and RAL7035 (550x950x160)	001101403	1
2	WP-A 6	3 position vertical Type A (900) (1set=left and right)	001101648	1
3	CP 2-1 M	Modular cover 24 mod. (500x150)	001101453	6
4	TH-S 2	Mounting rail 35/15 1.5 stalowa 465mm (500)	002911042	6
5	LG-V SET	Fixing element (1set=2pcs.)	001101683	6

Example 3. Wall-mounted enclosure 4XN160 3-7 with insert ready to install modular equipment and circuit breakers/disconnectors EB/ED 125, 160, 250A

Wall-mounted enclosure 4XN160 with IP41 degree of protection (it is possible to increase the degree of protection to IP44 by correct sealing SEAL-G9) 800 mm width, 1100 mm high, 160 mm depth. Enclosure suitable for mounting modular devices with total 252 moduls. In the following configuration, housing suitable for mounting 156 modules, 4 fuse-disconnectors NH00, 1 disconnecter/circuit breaker ED/EB 125, 160, 250A, perforated mounting plate for media application. The enclosure is divided vertically into fields: 1-st field (250 mm width) and 2-nd field (500 mm width). By using vertical bracket WP-A depth of the rails can be adjusted. An enclosure is mounted on the wall with UCH-2 holders.

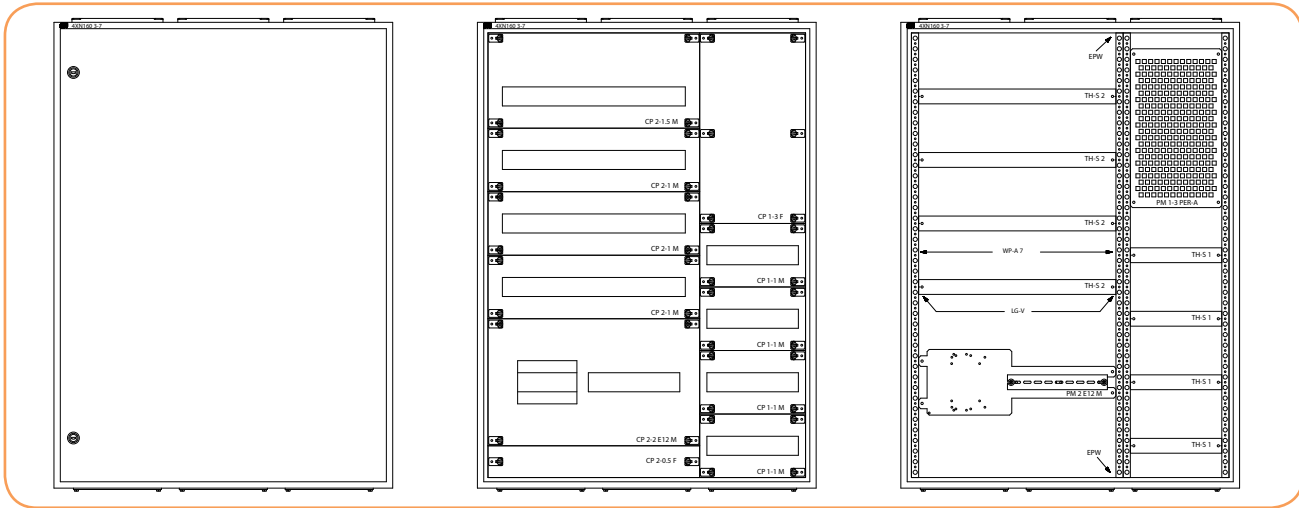

List of materials for 4XP160 3-7 enclosure with insert to modular equipment and circuit breakers/disconnectors EB/ED 125, 160, 250A

No.	Type	Product name	Code no.	Quantity to be ordered
1	4XN160 3-7	Wall-mounted enclosure empty, IP41, kl. I RAL7035 (800x1100x160)	001101409	1
2	CP 1-1 M	Modular cover 12 mod. (250x150)	001101451	4
3	WP-A 7	3 position vertical bracket Type A (1050) (1set=left and right)	001101650	2
4	CP 1-3 F	Plain cover (250x450)	001101443	1
5	CP 2-0.5 F	Plain cover (500x75)	001101426	1
6	CP 2-1 M	Modular cover 24 mod. (500x150)	001101453	3
7	CP 2-1.5 M	Modular cover 24 mod. (500x225)	001101459	1
8	CP 2-2 E12 M	Cover for 1xEB2/ED2 125,160,250A 3,4P and 12 mod. (500x300)	001101483	1
9	EPW	Dividing set (1set=2pcs.)	001101677	1
10	PM 1-3 PER-A	Perforated mounting plate Type A (250)	001101622	1
11	PM 2 E12 M	Mounting plate 1xEB2/ED2 with rail TH35 for 12 mod. (500)	001101572	1
12	TH-S 1	Mounting rail 35/15 1.5 steel 215mm (250)	002911040	4
13	TH-S 2	Mounting rail 35/15 1.5 steel 465mm (500)	002911042	4
14	UCH-2	Handle for enclosure hanging (1set=2pcs.)	001101715	1
15	LG - V SET	Fixing element (1set=2pcs.)	001101683	12

Example 4. Wall-mounted enclosure GT 100-60-25 with insert.

GT enclosure with IP65 protection 1000 mm high, 600 mm wide, 250 mm deep with insert for modular equipment and MCCB circuit breakers, disconnectors, fuse-disconnectors. The following set allows to install the equipment with total of 66 modules and 4 fuse-disconnectors NH00, 1 MCCB disconnector ED or circuit breaker EB 125, 160, 250A. There is also the possibility to install additional devices directly on the GT mounting plate besides insert (two levels of assembly).

