

Power distribution blocks
 Rozvodné bloky
 Bloki dystrybucyjne
 Blocuri de distribuție
 Verteilerblöcke
 Bloc de distribution
 Силовые распределительные блоки
 Клемореди
 Distributivni blok
 Distribucijski blok
 Elosztóblokk
 Paskirstymo gnybtų bloškai
 Strāvas sadales spaiļu bloks
 Jaotuskilbid
 Morsetiera di distribuzione
 Bloques repartidores
 Verdelerblokken

A

Mounting instruction
 Montážni návod
 Montážny návod
 Instrukcja montażu
 Instrucțiuni de asamblare
 Montageanweisung
 Instructions de montage
 Инструкция по монтажу
 Monteringsanvisning
 Istruzioni di montaggio
 Instrucciones de montaje
 Összeszerelési útmutató
 Asennusohjeita

Montage-instructies
 Instruções de montagem
 Navodila za montažo
 Οδηγίες Εγκατάστασης
 Инструкции за инсталиране
 Monteringsvejledning
 Montažu upute
 Montavimo instrukcijos
 Instalēšanas instrukcijas
 Uputstvo za montažu
 Paigaldusjuhendid
 Інструкція з монтажу

B

Caution: Installation by electricians only

Varování: Montáž pouze osobou s elektrotechnickou kvalifikací

Varovanie: Montáž smie vykonávať iba osoba s elektrotechnickou kvalifikáciou

Uwaga: Montaż tylko przez uprawnionych instalatorów

Atentie: Instalare numai de catre electricieni

Vorsicht: Montagenur durch Elektrofachkräfte

Attention: Montage uniquement par un électricien

Осторожно: Установка данного оборудования производится только специалистом – электриком

Attenzione: L'installazione deve essere eseguita solamente da personale qualificato

Atención: Este dispositivo debe ser manipulado únicamente por personal cualificado

Figyelem: Szerelést kizárólag szakember végezheti

Внимание: Монтаж само от ел.специалисти

Dėmesio: montavimo darbus gali atlikti tik kvalifikuotas specialistas-elektrikas

Upozorenje: Montažu izvodi samo stručno lice





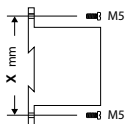
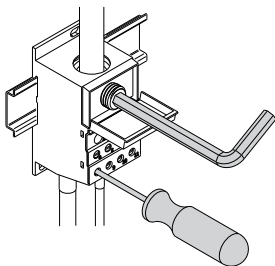













Обережно: монтаж виконує виключно електрик

C



	X
103778 / 103789	53.5 mm
103780 / 103781	62.6 mm
103782 / 103783	81.5 mm
103784 / 103785	86.0 mm
103786 / 103787	86.0 mm

D

	I_{\max} Cu / Al	U_{\max}			
103778 103779	80 A / - 80 / 63 A	1000 V AC 1500 V DC	1x 2.5-16 mm ² 2x 2.5-16 mm ² 4x 2.5-6 mm ²	1x 1.5-3 Nm 2x 1.5-3 Nm 4x 0.8-1.5 Nm	1x  2x  4x 
103780 103781	125 A / - 125 / 100 A		1x 10-35 mm ² 1x 2.5-16 mm ² 6x 2.5-16 mm ²	1x 3.5-5 Nm 1x 1.5-3 Nm 6x 2-3 Nm	1x  1x  6x 
103782 103783	160 A / - 160 / 125 A		1x 10-70 mm ² 6x 2.5-16 mm ²	1x 5-6 Nm 6x 1.5-3 Nm	1x  6x 
103784 103785	250 A / - 250 / 200 A		1x 35-120 mm ² 2x 6-35 mm ² 5x 1.5-16 mm ² 4x 1.5-10 mm ²	1x 19-21 Nm 2x 3.5-7 Nm 5x 2-3 Nm 4x 2-3 Nm	1x  2x  5x  4x 
103786 103787	400 A / - 400 / 300 A		1x 95-185 mm ² 2x 6-35 mm ² 5x 1.5-16 mm ² 4x 1.5-10 mm ²	1x 25 Nm 2x 3.5-7 Nm 5x 2-3 Nm 4x 2-3 Nm	1x  2x  5x  4x 

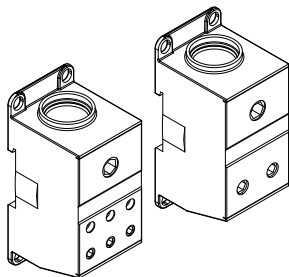

A

Mounting instruction
 Montážní návod
 Montážny návod
 Instrukcja montażu
 Instructiuni de asamblare
 Montageanweisung
 Instructions de montage
 Инструкция по монтажу
 Monteringsanvisning
 Istruzioni di montaggio
 Instrucciones de montaje
 Összeszerelési útmutató
 Asennusohjeita

B

Caution: Installation by electricians only
 Varování: Montáž pouze osobou s elektrotechnickou kvalifikací
 Varovanie: Montáž smie vykonávať iba osoba s elektrotechnickou kvalifikáciou
 Uwaga: Montaż tylko przez uprawnionych instalatorów
 Atentie: Instalare numai de catre electricieni
 Vorsicht: Montagenur durch Eletrofachkräfte
 Attention: Montage uniquement par un électricien
 Осторожно: Установка данного оборудования производится только специалистом – электриком
 Attenzione: L'installazione deve essere eseguita solamente da personale qualificato
 Atención: Este dispositivo debe ser manipulado únicamente por personal cualificado
 Figyelem: Szerelést kizárólag szakember végezheti
 Внимание:Монтаж само от ел.специалисти
 Dėmesio: montavimo darbus gali atlikti tik kvalifikuotas specialistas-elektrikas
 Upozorenje: Montažu izvodi samo stručno lice
 Обережно: монтаж виконує виключно електрик





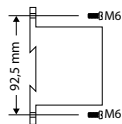
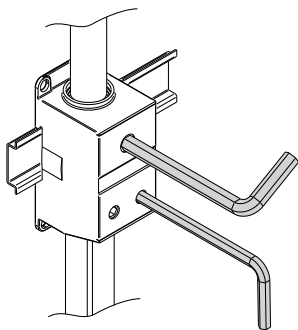

Power distribution blocks
 Rozvodné bloky
 Bloki dystrybucyjne
 Blocuri de distribuție
 Verteilerblöcke
 Bloc de distribution
 Силовые распределительные блоки
 Клемореди
 Distributivni blok
 Distribucijski blok
 Elosztóblokk
 Paskirstymo gnybtų blokai
 Strāvas sadales spaiļu bloks
 Jaotuskilbid
 Morsettiere di distribuzione
 Bloques repartidores
 Verdelerblokken

Montage-instructies
 Instruções de montagem
 Navodila za montažo
 Οδηγίες Εγκατάστασης
 Инструкции за инсталиране
 Monteringsvejledningene
 Montažu upute
 Montavimo instrukcijos
 Instalēšanas instrukcijas
 Uputstvo za montažu
 Paigaldusjuhendid
 Інструкція з монтажу

C



D

	I_{\max} Cu / Al	U_{\max}			
105509 103795	400 A / - 400 / 350 A	1000 V AC 1500 V DC	1x 95-240 mm ² 6x 10-50 mm ²	1x 25 Nm 6x 3.5-7 Nm	1x  6x 
105510 103796	400 A / - 400 / 300 A		1x 95-240 mm ² 2x 50-120 mm ²	1x 25 Nm 2x 19 Nm	1x  2x 

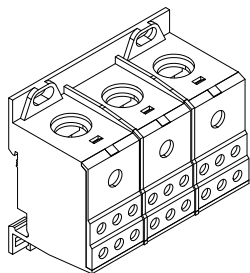

A

Mounting instruction
 Montážní návod
 Montážny návod
 Instrukcja montażu
 Instrucțiuni de asamblare
 Montageanweisung
 Instructions de montage
 Инструкция по монтажу
 Monteringsanvisning
 Istruzioni di montaggio
 Instrucciones de montaje
 Összeszerelési útmutató
 Asennusohjeita

B

Caution: Installation by electricians only
 Varování: Montáž pouze osobou s elektrotechnickou kvalifikací
 Varovanie: Montáž smie vykonávať iba osoba s elektrotechnickou kvalifikáciou
 Uwaga: Montaż tylko przez uprawnionych instalatorów
 Atentie: Instalare numai de catre electricieni
 Vorsicht: Montagenur durch Eletrofachkräfte
 Attention: Montage uniquement par un électricien
 Осторожно: Установка данного оборудования производится только специалистом – электриком
 Attenzione: L'installazione deve essere eseguita solamente da personale qualificato
 Atención: Este dispositivo debe ser manipulado únicamente por personal cualificado
 Figyelem: Szerelést kizárólag szakember végezheti
 Внимание:Монтаж само от ел.специалисти
 Dêmesio: montavimo darbus gali atlikti tik kvalifikuotas specialistas-elektrikas
 Upozorenje: Montažu izvodi samo stručno lice
 Обережно: монтаж виконує виключно електрик



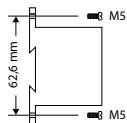
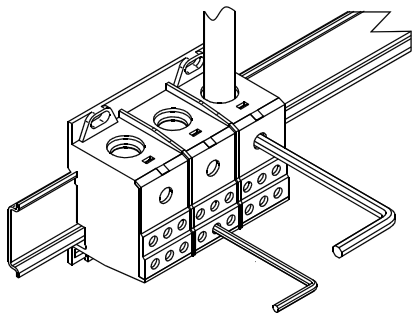

Power distribution blocks
 Rozvodné bloky
 Bloki dystrybucyjne
 Blocuri de distribuție
 Verteilerblöcke
 Bloc de distribution
 Силовые распределительные блоки
 Клемореди
 Distributivni blok
 Distribucijski blok
 Elosztóblokk
 Paskirstymo gnybtų blokai
 Strāvas sadales spaiļu bloks
 Jaotuskilbid
 Morsettieria di distribuzione
 Bloques repartidores
 Verdelerblokken

Montage-instructies
 Instruções de montagem
 Navodila za montažo
 Οδηγίες Εγκατάστασης
 Инструкции за инсталиране
 Monteringsvejledningene
 Montažu upute
 Montavimo instrukcijos
 Instalēšanas instrukcijas
 Uputstvo za montažu
 Paigaldusjuhendid
 Інструкція з монтажу

C



D

	I_{\max} Cu / Al	U_{\max}			
103788 103789	175 A / - 175 / 125 A	1000 V AC 1500 V DC	3x 10-70 mm ² 18x 2.5-16 mm ²	3x 6-10 Nm 18x 3-4 Nm	3x  18x 