

Mini Contactors

Dimensions

AC and DC operated
with screw terminals

K1-07D..
K1-09D..
K1-12D..

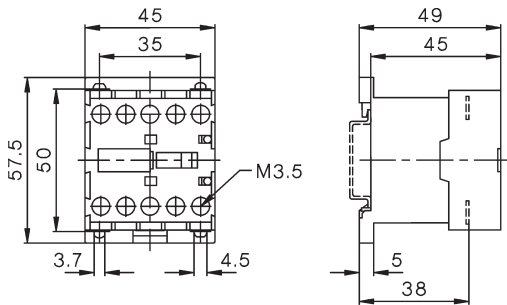

with fast on terminals

K1-07F..
K1-09F..

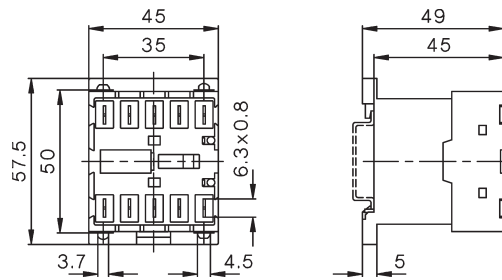

AC and DC operated
with solder connections

K1-07L..
K1-09L..

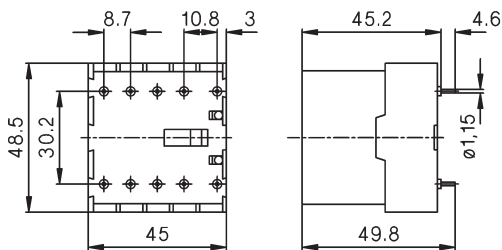

Auxiliary Contact Blocks

HK..

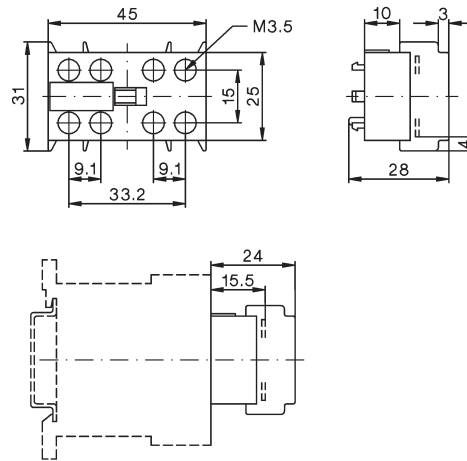

Suppressor Units

RC-K1

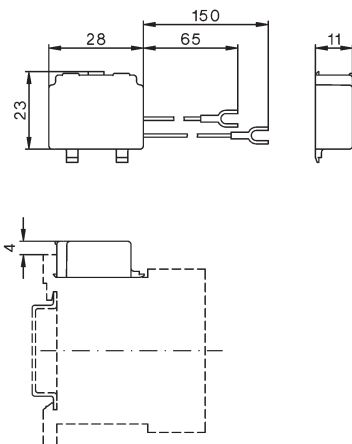

Reversing Contactors

K1W09D..MC
K1W12D..MC

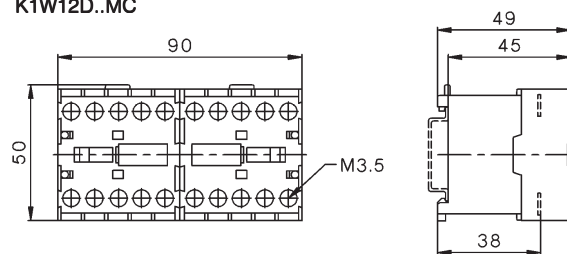

Reversing Contactors

K1W09L..MC

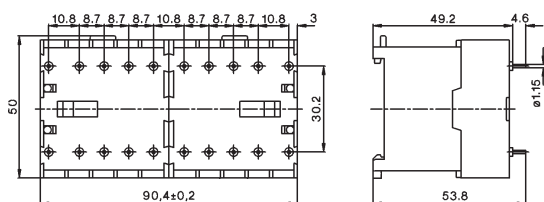

K1W09D..MC + U12/16E K1
K1W09D..MC + U12/16E K1

