

30 AÑOS JUNTOS
ANS ENSEMBLE
YEARS TOGETHER

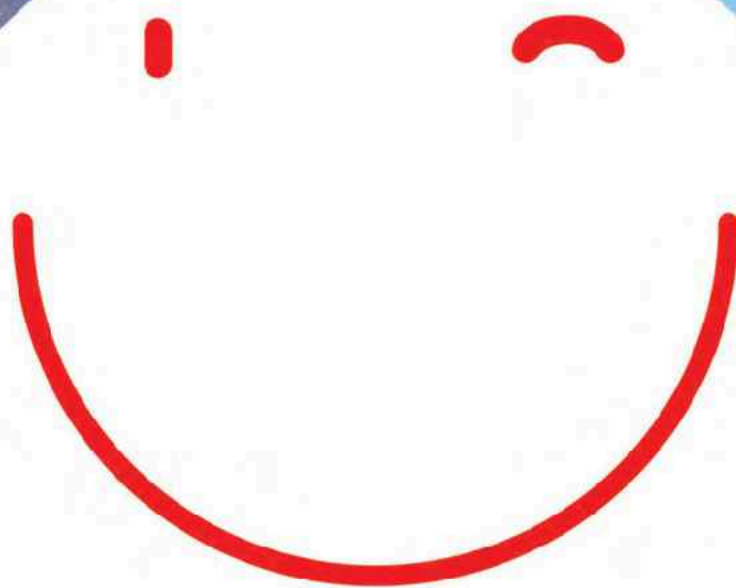

 **airfal**
INTERNATIONAL
CATÁLOGO
CATALOGUE



CATÁLOGO

CATALOGUE





¡CUMPLIMOS 30 AÑOS!

WE TURN 30 YEARS OLD!

NOUS FÊTONS NOS 30 ANS!



CARTA CONSEJO DE ADMINISTRACIÓN
BOARD OF DIRECTORS LETTER
LETTRE DU CONSEIL D'ADMINISTRATION

Tras todos estos años tratando de hacer las cosas lo mejor posible y mejorar día a día, hoy somos una empresa joven con mucha experiencia y con ganas de seguir aprendiendo.

Han pasado muchos años desde que Fernando Ariza fundó esta empresa familiar. Comenzó su incursión en el mundo de la iluminación con un único modelo: EL MODELO 1; luminaria decorativa de aluminio que sigue hoy en día en el catálogo junto con cientos de referencias de un portfolio de productos que se ha ido ampliando y desarrollando según las necesidades del mercado.

After all these years trying to do things the best that we can and improve day by day, today we are a young Company with a lot of experience and look forward to continue learning.

Many years have passed since Fernando Ariza founded this family Company. Its incursion in the lighting world started with an only model: MODEL 1; aluminum decorative light fitting that is still in our catalogue to this day, together with hundreds of references in a product portfolio that has been increasing and developing according to the market needs.

Après toutes ces dernières années en essayant de faire les choses le mieux possible et de progresser de façon continue, aujourd'hui nous sommes une jeune société avec beaucoup d'expérience et d'enthousiasme pour continuer notre processus d'apprentissage.

Beaucoup de temps est passé depuis que Monsieur Fernando Ariza fonda cette société familiale. Il commença dans le monde de l'éclairage avec son unique modèle: LE MODÈLE 1. Luminaire décoratif en aluminium qui est toujours sur notre catalogue avec des centaines de références dans une sélection qui n'a fait que s'agrandir et se développer en fonction des exigences du marché.





Se han producido muchos cambios: tecnológicos, competidores, materiales ... todos han sido superados con creces, fortaleciéndonos para ayudarnos a no parar de crecer. Vamos consiguiendo las metas que nos proponemos; Internacionalizándonos cada vez más, con un producto muy diferenciado y personalizado de alta especificación técnica que ayuda a que el resultado de la solución lumínica sea la más adecuada, y haciendo de nuestra empresa un lugar donde la gente quiera trabajar, con quién la gente quiera hacer negocios y donde beneficiemos a nuestro entorno, gracias a un elevado compromiso social.

Nos gustaría aprovechar para agradecer a todos los que han ayudado a llegar hasta aquí: Clientes, Proveedores y todos los que han formado el equipo de Airfal.

¡Esto es sólo el comienzo de una gran historia que nos gustaría compartir con todos vosotros por muchos años más!

There have been many changes: technology, competitors, materials, all have been wildly overcome, strengthening us, helping us to continue growing. We are reaching the goals that we set out to get. Internationalizing us more and more, with a very differentiated and personalized product of high technical specifications that make of the lighting solution to be the most appropriate. Making our company a place where people want to work, where people want to have business with and where we can improve our environment, thanks to our high social commitment.

We would like to thank all those who have helped us to get here: Customers, Suppliers and all those who have formed the team of Airfal.

This is just the beginning of a great story that we would like to share with all of you for many years to come!

Beaucoup de changements se sont produits : technologiques, concurrence, matériaux... et tous ont été largement dépassés, en nous faisant plus forts, tout en nous aidant à continuer à grandir. Nous sommes en train d'atteindre les objectifs que nous nous sommes fixés ; en nous internationalisant de plus en plus avec des produits de hautes spécifications techniques, différenciés et personnalisés, qui nous permettent d'obtenir des résultats où les solutions d'éclairage proposées sont les plus adéquates. Tout ceci fait de notre société un endroit où les personnes veulent travailler et avec laquelle de nombreuses sociétés veulent collaborer, tout en bénéficiant de notre entourage.

Nous voudrions profiter de l'occasion pour remercier à tous ceux qui nous ont aidés à arriver jusqu'ici : Clients, fournisseurs et tous ceux qui ont formé l'équipe d'Airfal.

Ceci n'est que le début d'une grande histoire que nous voudrions partager avec vous pour de nombreuses années dans l'avenir!



GANADOR PREMIO
A LA EXCELENCIA
EMPRESARIAL
EN ARAGÓN 2014

WINNER- CORPORATE
EXCELLENCE EFQM
AWARD
ARAGÓN 2014

GAGNANT- PRIX
D'EXCELLENCE
MANAGÉRIALE EFQM
ARAGÓN 2014

PYMES



LUMINARIAS LED
LED LUMINAIRES
LUMINAIRES LED

8

LUMINARIAS ESTANCAS
WATERPROOF LUMINAIRES
LUMINAIRES ÉTANCHES

38

ATEX
EX
ATEX

128

ILUMINACIÓN TÉCNICA
TECHNICAL LIGHTING
ÉCLAIRAGE TECHNIQUE

158

ILUMINACIÓN RESIDENCIAL
RESIDENTIAL LIGHTING
ÉCLAIRAGE RÉSIDENTIEL

212

KITS DE EMERGENCIA Y DATOS TÉCNICOS
EMERGENCY KIT AND TECHNICAL DATA
ÉCLAIRAGE DE SECOURS ET DONNÉES TECHNIQUES

262



LUMINARIAS LED

LED LUMINAIRES

LUMINAIRES LED

1.1	IP68	Pegaso	12
		Mustang	14
		Range	16
		Thunder	18
		Silver	20
1.2	IP67	Orion	24
		Excalibur	26
		Waled	28
		Emelux Led	30
1.3	IP65	Piston	32
1.4		Cuadro de aplicaciones Applications chart <i>Tableau d'applications</i>	34



TR3 personalizada / TR3 custom made / TR3 creation sur mesure

Estadio de Fútbol Nuevo San Mamés, Bilbao, España

New San Mamés Football Stadium, Bilbao, Spain

Nouveau Stade de Football de San Mamés, Bilbao, Espagne



TR3 personalizada / TR3 custom made / TR3 creation sur mesure

Estadio de Fútbol Nuevo San Mamés, Bilbao, España

New San Mamés Football Stadium, Bilbao, Spain

Nouveau Stade de Football de San Mamés, Bilbao, Espagne

1.1

Luminarias LED LED luminaires Luminaires LED



ES

Esta luminaria posee un grado de protección IP68 que ofrece una protección total contra el polvo y contra la inmersión de la luminaria. Debido a que debe soportar vibraciones, el reflector queda muy firmemente fijado sobre la guía. Se debe presionar el tubo para deslizar el reflector.

El plástico del tubo, así como las tapas está realizado en plástico V0, autoextinguible para zonas clasificadas M1.

Esta estanca es apropiada para aplicaciones como:

- Túneles.
- Autopistas y viales públicos.
- Hospitales.
- Garajes.
- Cualquier zona donde exista necesidad de instalar luminarias en material autoextinguible (zona M1).

Características generales

- Cuerpo luminaria: Policarbonato retardante de la llama (M1) de 2 mm anti UV opal.
- Reflector: Aluminio.
- Tapas: Plástico V0.
- Tensión alimentación: 220-240V, 50-60Hz. Para otras tensiones, consultar
- Temperatura de trabajo: De -20 °C a +40 °C
- Ensayo hilo incandescente: 960 °C.
- Accesorios: 2 bridas en acero inoxidable conexión rápida. Prensaestopas metálico PG-11.



Ficha técnica
Technical data
Fiche technique

Las luminarias de policarbonato no soportan hidrocarburos

Polycarbonate light fittings don't allow hydrocarbons
Les luminaires de polycarbonate ne supportent pas les hydrocarbures

EN

This luminaire has a degree of protection of IP68 offering total protection against dust and against the penetration of water in immersion. This luminaire is designed to support vibrations, so the reflector is very strongly fixed to the tube. The user must press the tube to move the reflector.

The plastic of the tube and the caps are made of plastic V0 flame retardant for classified zones M1.

This waterproof luminaire is suitable for many applications:

- Tunnels.
- Highway and public roads.
- Hospitals.
- Garages.
- Any zone where these exists need to install lights in autoextinguishable material (zone M1).

General characteristics

- Light fitting: Matte polycarbonate 2 mm thickness.
- Reflector: Aluminium.
- End caps: V0 Plastic.
- Power sources: 220-240V, 50-60Hz. For other power sources, please ask.
- Work temperature: -20 °C to +40 °C.
- Glow wire test: 960° C.
- Accessories: 2 Stainless fast opening clamps. Pg-11 metallic cablegland.

FR

L'indice de protection IP68 de ce luminaire offre une protection totale contre la poussière et la pénétration d'eau en immersion. En raison des vibrations auxquelles il devra résister, le réflecteur est fermement fixé à la tringle. Il faut exercer une pression sur le tube pour faire glisser le réflecteur.

Le tube ainsi que les embouts sont réalisés en plastique V0 auto-extinguible pour les zones classées M1.

Ce produit est adapté à un grand nombre d'applications:

- Tunnels .
- Autoroutes et voies publiques.
- Hôpitaux.
- Garages.
- Tout zone nécessitant l'installation de luminaires fabriqués à partir de matériaux autoextinguibles (zone M1).

Caractéristiques générales

- Corps du luminaire: Polycarbonate retardateur de flamme (M1) de 2 mm, anti-UV opale.
- Réflecteur: Aluminium.
- Embouts: Plastique V0.
- Alimentation: 220-240V, 50-60Hz. Pour toute autre tension, veuillez nous consulter.
- Type d'ampoule: Modules led à courant constant.
- Température d'utilisation: -20 °C à +40 °C.
- Essai au fil incandescent: 960 °C.
- Accessoires inclus: 2 colliers de fixation à installation rapide en acier inoxydable. Presse-étoupe Métalliques PG-11.

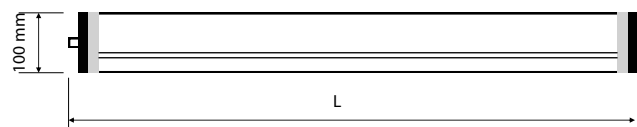

Ref.	Potencia Watts <i>Puissance</i>	Emisión Light emission <i>Intensité lumineuse</i>	Largo Length <i>Longueur</i>	Ancho Wide Large	Embalaje Packaging Carton	Raee European recyclable <i>Ecotaxe</i>	Precio Price <i>Prix</i>
Q0853	13 W	1.900 Lm	675	100	1	0,50 €	256,63 €
Q0854	26 W	3.800 Lm	1.285	100	1	0,50 €	384,19 €
Q0855	32 W	4.750 Lm	1.589	100	1	0,50 €	405,73 €

Emisión con leds de temperatura de color 4000 °K. Otras configuraciones de potencia/emisión o posibilidad de regulación, a consultar según proyecto.

Light emission level using 4000°K color temperature led modules. Other power or light emission configurations, dimming options, etc... please consult us.

Intensité avec des LED de température de couleur 4000 °K. Pour toute autre configuration de puissance/intensité ou possibilité de régulation, veuillez nous consulter en fonction de votre projet.

ACCESORIOS / ACCESSORIES / ACCESSOIRES

REF. Q0349

12,21 €



Suspensión con cable de acero
Steel cable suspension
Suspension avec câble en acier

REF. Q0348

7,25 €



**Bridas de acero inoxidable de
apertura rápida**
(incremento de precio 2 uds.)
**Quick opening stainless steel
clamps** (price increase 2 units.)
*Colliers inox de ouverture rapide à
grenouillère* (plus value de prix 2 uts.)

1.1

Luminarias LED LED luminaires Luminaire LED



Brida
Clamp
Collier

ES

Su cuerpo de policarbonato de 3,5 mm de espesor le da una extraordinaria resistencia contra impactos, obteniendo un índice de protección IK10.

La envolvente se adapta perfectamente a condiciones adversas de polvo y humedad gracias a su excelente estanqueidad, obteniendo un grado de protección IP68, pudiendo ser sumergida a 2 metros de profundidad.

Características generales

- Cuerpo luminaria: Policarbonato 3,5 mm de espesor opal.
- Soporte interno leds: Aluminio.
- Tapas finales: Acero inoxidable 316. Cierre mediante tornillo con junta de elastómero termoplástico. Tornillo estanco inoxidable.
- Tensión alimentación: 220-240V, 50-60Hz.
- Fuente de luz: Módulos LED.
- Temperatura de trabajo: De -20 °C a +40 °C.
- Accesorios incluidos: 2 Bridas en acero inoxidable apertura rápida. Prensaestopas metálicos.

EN

Its 3,5mm. polycarbonate body gives it extraordinary protection against impacts, giving it an IK10 protection rating.

The lasing is perfectly suited to dusty or wet conditions. Thanks to its excellent protection rating IP68, allows it to be submerged up to 2 meters.

General characteristics

- Light fitting: Matte polycarbonate 3,5 mm thickness.
- Leds base: Aluminium.
- End caps: 316 stainless steel. Close by screw thermoplastic elastomer seal. Stainless steel screw.
- Power source: 220-240V, 50-60Hz.
- Lamp: Led modules.
- Ambient work temperature: -20 °C - +40 °C.
- Included accessories: 2 fast opening stainless Steel clamps. Cable gland Metallic.

FR

Son corps en polycarbonate de 3,5 mm d'épaisseur lui confère une extraordinaire résistance aux chocs, obtenant ainsi un degré de protection IK10.

L'enveloppe s'adapte parfaitement aux conditions difficiles de poussière et d'humidité grâce à son excellente étanchéité, obtenant un degré de protection IP68 et pouvant être immergée à 2 mètres de profondeur.

Caractéristiques générales

- Corps: Polycarbonate anti-UV de 3,5 mm d'épaisseur opale.
- Support: Aluminium.
- Embouts: Acier inoxydable 316. Fermeture par vis avec joint en élastomère thermoplastique. Vis d'étanchéité inoxydable.
- Alimentation: 220-240V, 50-60Hz.
- Lampes: Modules led.
- Température d'utilisation: -20 °C à +40 °C.
- Accessoires inclus: 2 colliers inox d'ouverture rapide à grenouillère. Presse-étoupe Métalliques.



Ficha técnica
Technical data
Fiche technique



Ref.	Potencia Watts <i>Puissance</i>	Emisión Light emission <i>Intensité lumineuse</i>	Tª color Tª colour <i>Tª Couleur</i>	Largo Length <i>Longueur</i>	Ancho Wide <i>Large</i>	Embalaje Packaging <i>Carton</i>	Raee European recyclable <i>Ecotaxe</i>	Precio Price <i>Prix</i>
Q0856	13 W	1.900 Lm	4000 °K	683	96	6	0,50 €	288,27 €
Q0857	26 W	3.800 Lm	4000 °K	1.293	96	6	0,50 €	427,32 €
Q0858	32 W	4.750 Lm	4000 °K	1.593	96	6	0,50 €	476,66 €

OPCIÓN LÍNEA CONTINUA / CONTINUOUS LINE CONNECTION / CÂBLAGE TRAVERSANT

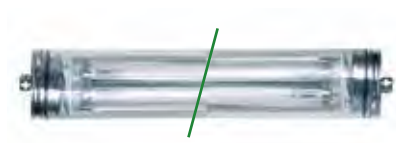

Existe la posibilidad de implementar un sistema de conexión en línea a las luminarias. El número máximo de luminarias a conectar dependerá de la potencia de las mismas. Compuesto de 2 prensaestopas, 2 fichas enchufables en los extremos y cableado de 2.5 mm².

There is a possibility of implementing a continuous line connection system to the light fitting. The maximum number of fittings to connect will depend on their wattage. For more information please contact our technical department.

2 Cable glands, 2 block connectors and 2.5 mm² joining cable.

Possibilité de connection en ligne continue. Le nombre de luminaires dépendra de la puissance.

2 Presse-étoupes, 2 fiches branchables aux xôtes et câblage de 2.5 mm².

3 polos / 3 poles / 3 pôles

REF. Q0565

23,09 €

5 polos / 5 poles / 5 pôles

REF. Q0566

35,35 €

ACCESORIOS / ACCESSORIES / ACCESSOIRES

REF. Q0153

9,30 €



Brida de policarbonato
Antivandalic polycarbonate
Colliers en polycarbonate

REF. Q0159

12,00 €



Bridas de acero cincado
Zinc-plated steel clamps
Colliers en acier galvanisé

REF. Q0656

22,50 €



Bridas de acero inoxidable con protección de caucho
Stainless steel clamps
Colliers inox antivandalisme

REF. Q0349

12,21 €



Suspensión con cable de acero

(sujeción con cable de acero utilizando las bridas de acero inoxidable con cáncamo)

Suspension with steel cable

Using stainless steel clamps and eyebolt

Suspension avec câble en acier

(fixation avec câble en acier en utilisant des colliers d'acier INOX avec piton)

1.1

Luminarias LED

LED luminaires

Luminaire LED



Brida
Clamp
Collier

ES

Esta luminaria está indicada en lugares con condiciones ambientales que requerirían el uso de materiales resistentes al ataque químico, o requerimientos de limpieza muy profunda.

Ejemplos:

- Farmacéuticos o químicos laboratorios.
- Fábricas de procesamiento de alimentos.
- Fábricas de piensos.
- Máquinas de cortar o fresar con la proyección del líquido refrigerante.
- Instalaciones hospitalarias.
- A petición, podemos fabricar con componentes especiales resistentes al cloro.

No es compatible para soportar productos químicos fluorados.

Características generales

- Cuerpo luminaria: Vidrio borosilicato 5 mm espesor.
- Chasis: Acero galvanizado.
- Tapas finales: Acero inoxidable 316. Cierre mediante tornillo con junta de elastómero termoplástico. Tornillo estanco inoxidable.
- Alimentación: 220-240V, 50-60Hz. 0,1-0,5 A.
- Lámparas: Módulos LED corriente constante.
- Temperatura de trabajo: -15 °C -/+35°C.
- Accesorios incluidos: 2 Bridas en acero inoxidable con protección de caucho. Prensaestopas metálicos.

EN

This luminaire is indicated in places with labor or environmental conditions which would require the use of materials resistant to chemical attack, or very deep cleaning requirements.

Examples:

- Pharmaceutical or chemical laboratories.
- Food processing factories.
- Feed mills.
- Cutting or milling machines with coolant projection.
- Hospital installations.
- On demand, we can manufacture with special components resistant to chlorine.

Not compatible to support fluorochemicals.

General characteristics

- Light fitting: Borosilicate glass 90x5 mm.
- Reflector: Galvanized steel chassis.
- End caps: 316 stainless steel. Close by screw thermoplastic elastomer seal. Screw tight steel.
- Power source: 220-240V, 50-60Hz. 0.15-0.25 A. For other voltages ask.
- Light source: Led modules.
- Work temperature: -15 °C to +35 °C.
- Accessories: 2 Fast opening stainless Steel clamps. Metallic cable gland.

FR

Ce luminaire est spécialement adapté aux lieux dont les conditions environnementales exigent l'utilisation de matériaux résistants aux agressions chimiques ou qui requièrent un nettoyage en profondeur.

Exemples d'application :

- Laboratoires pharmaceutiques ou chimiques.
- Usines de transformation des aliments.
- Usine d'aliments pour animaux.
- Machines de découpage ou de fraisage avec projection de liquide de refroidissement.
- Établissements hospitaliers.

Luminaire non résistant aux produits chimiques fluorés.

Caractéristiques générales

- Corps: Verre borosilicate de 5 mm d'épaisseur.
- Châssis: Acier galvanisé.
- Embouts: Acier inoxydable 316. Fermeture par vis avec joint en élastomère thermoplastique. Vis d'étanchéité inoxydable.
- Alimentation: 220-240 V, 50-60 Hz. 0,1-0,5 A.
- Ampoules: Modules led à courant constant.
- Température d'utilisation: de -15 °C à +35 °C.
- Accessoires inclus: 2 colliers de fixation en acier inoxydable avec protection en caoutchouc. Presse-étoupes métalliques.



Ficha técnica
Technical data
Fiche technique



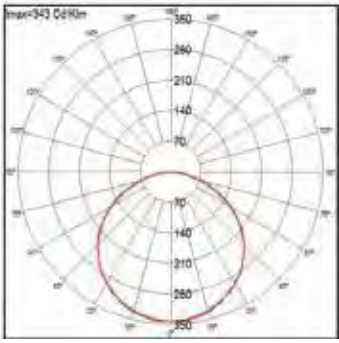

Ref.	Potencia Watts Puissance	Emisión Light emission Intensité lumineuse	Largo Length Longueur	Ancho Wide Large	Raee EU Recyclable tax Ecotaxe	Precio Price Prix
Q0859	13 W	1.900 Lm	673	96	0,50 €	426,64 €
Q0860	26 W	3.800 Lm	1.273	96	0,50 €	618,96 €
Q0861	32 W	4.750 Lm	1.573	96	0,50 €	631,04 €

Emisión lumínica para módulos de 4000°K. Otras configuraciones y potencias, a consultar.
Posibles opciones de regulación

Light emission for 4000°K led modules. Other configuration and powers, please ask.

Intensité lumineuse concernant les modules de 4000 °K. Pour les autres configurations et puissances, veuillez nous consulter. Possibilité de régulation.

ACCESORIOS / ACCESSORIES / ACCESSOIRES

REF. Q0349

12,21 €



Suspensión con cable de acero
Steel cable suspension
Suspension avec câble en acier

REF. Q0656

22,50 €



Bridas de acero inoxidable
(Inoxidable con protección de caucho)
Stainless Steel clamps with
rubber protection
Colliers inox antivandalisme

1.1

Luminarias LED LED luminaires Luminaires LED



Brida
Clamp
Collier

ES

Su cuerpo de policarbonato de 3,5 mm de espesor le da una extraordinaria resistencia contra impactos, obteniendo un índice de protección IK10.

La envolvente se adapta perfectamente a condiciones adversas de polvo y humedad gracias a su excelente estanqueidad, obteniendo un grado de protección IP68, pudiendo ser sumergida a 2 metros de profundidad.

Características generales

- Cuerpo luminaria: Policarbonato anti-UV de 3,5mm. de espesor opal.
- Soporte leds: Aluminio.
- Tapas finales: Zamak niquelado.
- Tensión alimentación: 220-240 V, 50/60 Hz. Para otras frecuencias consultar.
- Fuente de luz: Módulos LED.
- Temperatura de trabajo: De -20 °C a +40 °C.
- Ensayo hilo incandescente: 960 °C.
- Accesorios incluidos: 2 bridas de sujeción antivandálica en policarbonato de cierre con tornillos. Prensaestopas de latón niquelado.

EN

Its 3,5 mm. polycarbonate body gives it extraordinary protection against impacts, giving it an IK10 protection rating.

The lasing is perfectly suited to dusty or wet conditions. Thanks to its excellent protection rating IP68, allows it to be submerged up to 2 meters.

General characteristics

- Light fitting: Anti-UV polycarbonate 3,5 mm thickness matte.
- End caps: nickel-plated Zamak.
- Led base: Aluminium.
- Power source: 220-240V, 50-60Hz. For other voltages ask.
- Lamp type: Led modules.
- Work temperature: -20 °C to +40 °C.
- Glow wire test: 960° C.
- Accessories: 2 polycarbonate anti-vandalism clamp closed by screws. PG-11 nickel-plated glands.

FR

Son corps en polycarbonate de 3,5 mm d'épaisseur lui confère une extraordinaire résistance aux chocs, obtenant ainsi un degré de protection IK10.

L'enveloppe s'adapte parfaitement aux conditions difficiles de poussière et d'humidité grâce à son excellente étanchéité, obtenant un degré de protection IP68 et pouvant être immergée à 2 mètres de profondeur.

Caractéristiques générales

- Corps du luminaire: Polycarbonate anti-UV de 3,5 mm d'épaisseur geal opale.
- Embouts: Zamak nickelé.
- Led support: Aluminium.
- Alimentation: 220-240V, 50-60Hz. Pour d'autres pussances, contacter le département technique.
- Lampes: Modules LED linéaires.
- Température d'utilisation: -20 °C á +40 °C.
- Essai du fil incandescent: 960 °C.
- Accessoires inclus: 2 colliers de fixation anti vandalisme en polycarbonate. Presse-étoupes métallique.



Ficha técnica
Technical data
Fiche technique

Sistema simple: Compuesto de 2 prensaestopas, 2 fichas enchufables en los extremos y cableado de 2.5 mm².

Simple system: 2 Cable glands, 2 block connectors and 2.5 mm² joining cable.

Systemes: 2 Presse-étoupes, 2 fiches branchables aux côtes et câblage 2.5 mm².

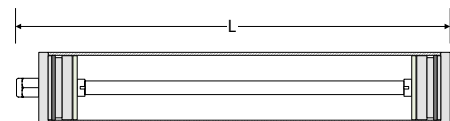
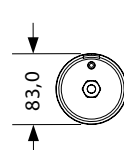

Ref.	Potencia Watts <i>Puissance</i>	Emisión Light emission <i>Intensité lumineuse</i>	Tª color Tª colour <i>Tª Couleur</i>	Largo Length <i>Longueur</i>	Ancho Wide <i>Large</i>	Embalaje Packaging <i>Carton</i>	Raee European recyclable <i>Ecotaxe</i>	Precio Price <i>Prix</i>
Q0862	13 W	1.900 Lm	4000 °K	709	83	6	0,50 €	240,74 €
Q0863	26 W	3.800 Lm	4000 °K	1.319	83	6	0,50 €	384,74 €
Q0864	32 W	4.750 Lm	4000 °K	1.574	83	6	0,50 €	436,27 €

OPCIÓN LÍNEA CONTINUA / CONTINUOUS LINE CONNECTION / CÂBLAGE TRAVERSANT

Existe la posibilidad de implementar un sistema de conexión en línea a las luminarias. El número máximo de luminarias a conectar dependerá de la potencia de las mismas.
 Ther is a possibility of implementing a continuous line system in the light fitting. The maximum number of fittings to connect will depend on their wattage.
 For more information please contact our technical department.
 Possibilité de connection en ligne continue. Le nombre de luminaires dépendra de la puissance.

ACCESORIOS / ACCESSORIES / ACCESSOIRES

REF. Q0655

22,50 €



Bridas de acero inoxidable
Stainless steel clamps
Colliers inox antivandalisme

REF. Q0349

12,21 €



REF. Q0156

7,40 €



Bridas de acero inoxidable de apertura rápida
Quick opening stainless steel clamps
Colliers inox de ouverture rapide à grenouillère

Suspensión con cable de acero

(sujeción con cable de acero utilizando las bridas de acero inoxidable con cáncamo)

Suspension with steel cable

Using stainless steel clamps and eyebolt

Suspension avec câble en acier
(fixation avec câble en acier en utilisant des colliers d'acier INOX avec piton)

REF. Q0403

43,91 €



Opción conexión rápida IP68

Incluye tubos fluorescentes

Quick IP68 connection option

Fluorescent lamps included

Option connectique rapide

WIELAND IP68

Lampes inclus

1.1

Luminarias LED

LED luminaires

Luminaires LED

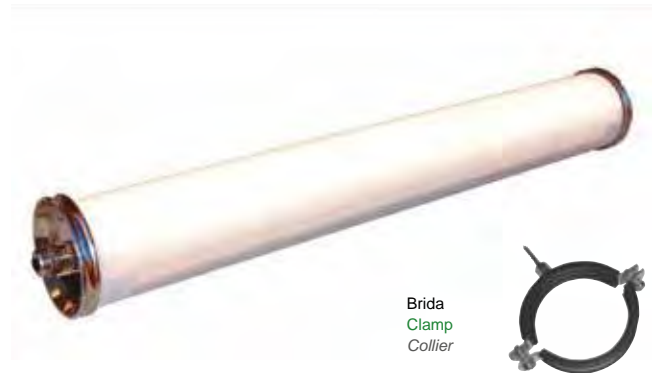

ES

Su cuerpo de metacrilato de 5 mm de espesor le da una extraordinaria resistencia contra impactos, obteniendo un índice de protección IK10. La envolvente se adapta perfectamente a condiciones adversas de polvo y humedad gracias a su excelente estanqueidad, obteniendo un grado de protección IP68, pudiendo ser sumergida a 2 metros de profundidad. Esta luminaria une la estanqueidad, la robustez y el diseño. Es la solución perfecta para iluminar espacios donde se requiera una luminaria con una alta calidad y capaz de soportar las peores condiciones y los hidrocarburos, lo que hace que sea ideal para su uso en: campanas de cocina industriales, viveros, fuentes, piscinas, iluminación directa de maquinaria (resistente a golpes), iluminación exterior.

Características generales

- Cuerpo luminaria: Metacrilato de 5 mm. de espesor opal.
- Chasis soporte: Aluminio.
- Tapas finales: Zamak niquelado.
- Tensión alimentación: 220-240 V, 50/60 Hz. Para otras tensiones consultar.
- Fuente de luz: Módulos LED.
- Temperatura de trabajo: De -20 °C a +40 °C.
- Ensayo hilo incandescente: 650° C.
- Accesorios incluidos: 2 bridas de acero cincado. Prensaestopas de latón niquelado.

EN

Its 5mm. acrylic body gives it extraordinary protection against impacts, giving it an IK10 protection rating. The lasing is perfectly suited to dusty or wet conditions. Thanks to its excellent protection rating IP68, allows it to be submerged up to 2 meters. This light fixture unites waterproofing, strength and design. It's the perfect solution to illuminate spaces that require a high quality fixture, that is able to stand the worst conditions and hydrocarbons, which makes it ideal for its use in: industrial cooking hoods, greenhouses, fountains, pools, direct tool lighting (resists direct hits), outdoor lighting.

General characteristics

- Light fitting: Acrylic 5 mm thickness matte.
- End caps: Zinc plated Zamak.
- Leds support: Aluminum.
- Power source: 220-240V, 50-60Hz. For other voltages ask.
- Lamp type: Led modules.
- Work temperature: -20 °C to +40 °C.
- Glow wire test: 650° C.
- Accessories: 2 polycarbonate clamps. PG-11 nickel-plated cable glands.

FR

Son corps de méthacrylate de 5 mm d'épaisseur lui donne une extraordinaire résistance face aux impacts, obtenant un indice de protection d'IK10. L'enveloppe s'adapte parfaitement aux conditions adverses de poussières et humidité grâce à son excellente étanchéité, obtenant un degré de protection IP68, pouvant être submergé à 2 mètres de profondeur. Ce luminaire unit l'étanchéité, la robustesse et le dessin. C'est la solution parfaite pour éclairer les espaces qui ont besoin d'un luminaire avec un éclairage de haute qualité et qui soit capable de supporter les pires conditions, cela fait qu'il soit idéal pour son usage dans : hottes de cuisines, pépinières, fontaines, piscines, cabines de peinture, éclairage direct de machinerie (résistante aux chocs), éclairage extérieur.

Caractéristiques générales

- Corps du luminaire: Méthacrylate 5 mm d'épaisseur opale.
- Embouts: Zamak nickelé.
- Support: Aluminium.
- Alimentation: 220-240V, 50-60Hz. Pour d'autres pussances, contacter le département technique.
- Lampes: Modules LED linéaires.
- Température d'utilisation: -20 °C à +40 °C.
- Essai du fil incandescent: 650 °C.
- Accessoires inclus: 2 colliers de fixation en acier galvanisé. Presse-étoupes métallique.



Ficha técnica
Technical data
Fiche technique

Sistema simple: Compuesto de 2 prensaestopas, 2 fichas enchufables en los extremos y cableado de 2.5 mm².

Simple system: 2 Cable glands, 2 block connectors and 2.5 mm² joining cable.

Systèmes: 2 Presse-étoupes, 2 fiches branchables aux côtes et câblage 2.5 mm².

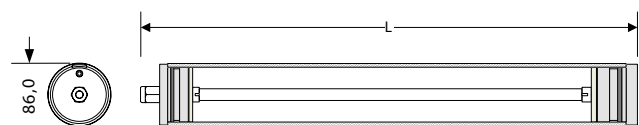

Las luminarias de policarbonato no soportan hidrocarburos

Polycarbonate light fittings don't allow hydrocarbons

Les luminaires de polycarbonate ne supportent pas les hydrocarbures

Ref.	Potencia Watts Puissance	Emisión Light emission Intensité lumineuse	Tª color Tª colour Tª couleur	Largo Length Longueur	Ancho Wide Large	Embalaje Packaging Carton	Raee European recyclable Ecotaxe	Precio Price Prix
Q0865	13 W	1.900 Lm	4000 °K	709	83	6	0,50 €	265,53 €
Q0866	26 W	3.800 Lm	4000 °K	1.319	83	6	0,50 €	432,55 €
Q0867	32 W	4.750 Lm	4000 °K	1.574	83	6	0,50 €	495,57 €

OPCIÓN LÍNEA CONTINUA / CONTINUOUS LINE CONNECTION / CÂBLAGE TRAVERSANT

Existe la posibilidad de implementar un sistema de conexión en línea a las luminarias. El número máximo de luminarias a conectar dependerá de la potencia de las mismas.
 There is a possibility of implementing a continuous line system to the light fitting. The maximum number of fittings to connect will depend on their wattage.
 For more information please contact our technical department.
 Possibilité de connection en ligne continue. Le nombre de luminaires dépendra de la puissance.

ACCESORIOS / ACCESSORIES / ACCESSOIRES

REF. Q0401

30,17 €



Bridas de acero inoxidable
Stainless steel clamps
 Colliers inox antivandalisme

REF. Q0349

12,21 €



REF. Q0402

7,40 €



Bridas de acero inoxidable de apertura rápida
Quick opening stainless steel clamps
 Colliers inox de ouverture rapide à grenouillère

REF. Q0158

1,00 €



Brida de metacrilato (1 unidad)
Antivandalic acrylic (1 unit)
 Colliers en méthacrylate (1 unité)

REF. Q0403

43,86 €



Suspensión con cable de acero
 (sujeción con cable de acero utilizando las bridas de acero inoxidable con cáncamo)
Suspension with steel cable
 Using stainless steel clamps and eyebolt
Suspension avec câble en acier
 (fixation avec câble en acier en utilisant des colliers d'acier INOX avec piton)

Conectores estancos de conexión rápida
 Compuesto por 2 conectores estancos y cableado de 2.5 mm². Existe también la posibilidad de usar una manguera para ángulos o espacios que no requieran iluminación.
Quick connection
 Composed by 2 connectors monopolies and wired up of 2.5 mm².
 There exists also the possibility of using a hose for angles or spaces that do not need lighting.
Connecteurs étanches de connection rapide
 2 connecteurs étanches et câblage de 2.5 mm².



Luminaria personalizada tubular opal con módulos LED IP68 Meandro de Aranzadi, Pamplona, España

Custom tubular opal luminaire with LED modules IP68 Aranzadi Meander, Pamplona, Spain

Luminaire creation sur mesure de tubulaire opale avec des modules LED IP68 Méandre d'Aranzadi, Pampelune, Espagne



Luminaria personalizada tubular opal con módulos LED IP68 Meandro de Aranzadi, Pamplona, España

Custom tubular opal luminaire with LED modules IP68 Aranzadi Meander, Pamplona, Spain

Luminaire creation sur mesure de tubulaire opale avec des modules LED IP68 Méandre d'Aranzadi, Pampelune, Espagne

1.2

Luminarias LED LED luminaires Luminaires LED



Brida
Clamp
Collier

ES

Luminaria en policarbonato de 1 mm de espesor y terminales en ABS, se incluyen bridas de sujeción facilitando la labor del montaje del instalador. Esta luminaria posee un grado de protección IP67 que ofrece protección total contra el polvo y contra la penetración de agua en cantidad perjudicial en el interior de la envolvente sumergida en agua, que la hace ideal para su uso en cámaras frigoríficas, viveros, fuentes, piscinas y gimnasios, invernaderos, puentes.

Características generales

- Cuerpo luminaria: Policarbonato de 1 mm de espesor opal.
- Chasis soporte: Aluminio.
- Tapas finales: A.B.S.
- Tensión alimentación: 220-240V, 50-60Hz.
- Fuente de luz: Módulos LED.
- Temperatura de trabajo: De -20 °C a +45 °C.
- Ensayo hilo incandescente: 850° C.
- Accesorios incluidos: 2 bridas de sujeción de policarbonato. Prensaestopas de poliamida PG-11.

EN

1 mm thick polycarbonate and A.B.S. terminals, ceiling clamps included, making installation easier. This light fixture has a IP67 protection grade, which offers total protection against dust and water seepage in prejudicial quantities in the interior of the cavity submerged in water, which makes it ideal for its use in refrigeration rooms, greenhouses, pools, health clubs and bridges.

General characteristics

- Light fitting: Matte polycarbonate 1 mm. Thickness.
- End caps: A.B.S.
- Led support: Aluminium.
- Power source: 220-240V, 50-60Hz. For other power sources, please ask.
- Light source: LED modules.
- Work temperature: -20 °C to +45 °C.
- Glow wire: Test 850° C.
- Accesorios (included): 2 Ceiling polyamide clamps. PG-11 plastic cable glands.

FR

Le modèle TR3 est un luminaire étanche de conception offrant de hautes prestations avec une étanchéité IP67.

Luminare en polycarbonate de 1 mm d'épaisseur et embouts en A.B.S., on inclue des colliers de fixation antivandaliques en polycarbonate.

Ce luminaire possède un degré de protection IP67 qui offre une protection totale face à la poussière et face à l'eau, ce qui le fait idéal pour son utilisation dans des chambres frigorifiques, pépinières, fontaines, piscines, gymnases, serres, ponts.

Caractéristiques générales

- Corps du luminaire: Polycarbonate 1 mm d'épaisseur opale.
- Embouts: A.B.S.
- Support: Aluminium.
- Alimentation: 220-240V, 50-60Hz (électronique). Pour d'autres puissances, contacter le département technique.
- Source de lumière: Modules LED linéaires.
- Température d'utilisation: -20 °C à +45 °.
- Essai du fil incandescent: 850 °C.
- Accessoires inclus: 2 colliers de fixation antivandalisme en polycarbonate. Presse-étoupe PG-11.



Ficha técnica
Technical data
Fiche technique

Sistema simple: Compuesto de 2 prensaestopas, 2 fichas enchufables en los extremos y cableado de 2.5 mm².

Simple system: Consists of 2 glands, 2 plug-in knobs at the ends and 2.5 mm² wiring.

Systèmes: 2 Presse-étoupes, 2 fiches branchables aux côtes et câblage 2.5 mm².

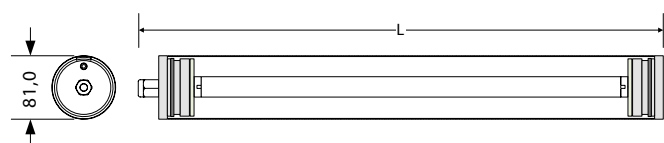

Las luminarias de policarbonato no soportan hidrocarburos

Polycarbonate light fittings don't allow hydrocarbons

Les luminaires de polycarbonate ne supportent pas les hydrocarbures

Ref.	Potencia Watts <i>Puissance</i>	Emisión Light emission <i>Intensité lumineuse</i>	Tª color Tª colour <i>Tª couleur</i>	Largo Length <i>Longueur</i>	Ancho Wide <i>Large</i>	Embalaje Packaging <i>Carton</i>	Raee European recyclable <i>Ecotaxe</i>	Precio Price <i>Prix</i>
Q0868	13 W	1.900 Lm	4000 °K	673	96	6	0,50 €	161,47 €
Q0869	26 W	3.800 Lm	4000 °K	1.273	96	6	0,50 €	266,46 €
Q0870	32 W	4.750 Lm	4000 °K	1.573	96	6	0,50 €	299,94 €

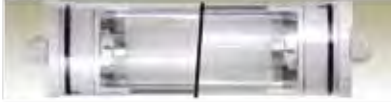

OPCIÓN LÍNEA CONTINUA / CONTINUOUS LINE CONNECTION / CÂBLAGE TRAVERSANT



Existe la posibilidad de implementar un sistema de conexión en línea a las luminarias. El número máximo de luminarias a conectar dependerá de la potencia de las mismas
There is a possibility of implementing a rapid connection system to the light, to ease continuous line production. The maximum number of fittings to connect will depend on their wattage.

Possibilité de connection en ligne continue. Le nombre de luminaires dépendra de la puissance.

ACCESORIOS / ACCESSORIES / ACCESSOIRES

<p>REF. Q0338 9,63 €</p>  <p>Bridas de acero cincado Zinc-plated steel clamps <i>Colliers en acier galvanisé</i></p>	<p>REF. Q0347 18,21 €</p>  <p>Bridas de acero inoxidable Stainless steel clamps <i>Colliers inox antivandalisme</i></p>	<p>REF. Q0348 7,25 €</p>  <p>Bridas de acero inoxidable de apertura rápida Quick opening stainless steel clamps <i>Colliers inox de ouverture rapide à grenouillère</i></p>
<p>REF. Q0349 12,21 €</p>  <p>Suspensión con cable de acero Steel cable suspension <i>Suspension avec câble en acier</i></p>	<p>REF. Q0351 47,40 €</p>  <p>Conexión rápida (Compuesto por 2 conectores estancos IP 68) Quick connection (2 waterproof connectors IP 68) <i>Connecteurs étanches de connection rapide (2 connecteurs étanches IP 68)</i></p>	<p>REF. Q0339 37,41 €</p>  <p>Tapas metálicas y racor metálico Metallic end caps and cable glands <i>Embouts et presse-étoupes métalliques</i></p>

1.2

Luminarias LED LED luminaires Luminaires LED



Brida
Clamp
Collier

ES

Siguiendo la línea de la luminaria TR3, el modelo TR4 ofrece un amplio abanico de posibilidades gracias a sus reducidas dimensiones, manteniendo una excelente estanqueidad IP67.

Para casos en los que el espacio disponible sea muy reducido, **existe la posibilidad de realizar modelos asimétricos**, reduciendo así la longitud de la luminaria.

Esta luminaria posee un grado de protección IP67 que ofrece protección total para el polvo y contra la penetración en cantidad perjudicial en el interior de la envolvente sumergida en agua, que la hace ideal para su uso en viveros, fuentes, piscinas, invernaderos, spas, etc.

Características generales

- Cuerpo luminaria: Policarbonato de 2,5 mm de espesor opal.
- Chasis: Aluminio.
- Tapas finales: A.B.S.
- Tensión alimentación: 220-240V, 50-60Hz (electrónica).
- Fuente de luz: Módulos led.
- Temperatura de trabajo: De -25 °C a +40 °C
- Ensayo hilo incandescente: 850 °C.
- Accesorios: 2 bridas de sujeción de A.B.S. Prensaestopas de poliamida PG-11.

EN

In the same line as the TR3, the TR4 can be used for a wide range of purposes, as it is smaller but retains an excellent IP67 water-resistancy.

For situations in which space is limited, **it is possible to produce asymmetrical models**, thus reducing the length of the light fitting.

This light fixture has IP67 protection degree, that offers a shield against dust and water penetration in prejudicial quantities inside the incapsulate submerged in water, which makes it ideal for its utilization in nurseries, fountains, pools, greenhouses, spas, etc.

General characteristics

- Light fitting: Matte polycarbonate 2,5 mm. Thickness.
- Internal structure: Aluminum.
- End caps: A.B.S.
- Power source: 220-240V, 50-60Hz.
- Light source: Led modules.
- Work temperature: -25 °C to +40 °C.
- Glow wire test: 850° C.
- Accessories: 2 A.B.S. polyamide Clamps. PG-11 polyamide glands.

FR

Suivant la ligne du luminaire TR3, le modèle TR4 offre beaucoup de possibilités grâce à ses petites dimensions, en maintenant une excellente étanchéité.

Pour les situations d'encombrements réduits, **il existe la possibilité de réaliser des modèles asymétriques**, en réduisant la longueur du luminaire.

Ce luminaire possède un degré de protection IP67 qui offre une protection total face à la poussière et face à l'eau, ce qui la fait idéale pour son utilisation dans des pépinières, fontaines, piscines, serres, spas, etc.

Caractéristiques générales

- Corps du luminaire: Polycarbonate de 2,5 mm d'épaisseur opale.
- Châssis: Aluminium.
- Embouts: A.B.S.
- Tension d'alimentation: 220-240 V, 50-60 Hz (électronique)
- Source de lumière: Modules led.
- Température d'utilisation: -25 °C à +40 °C.
- Essai au fil incandescent: 850 °C.
- Accessoires: 2 colliers de fixation en A.B.S. Presse-étoupe en polyamide PG-11.



Ficha técnica
Technical data
Fiche technique

Las luminarias de policarbonato no soportan hidrocarburos
Polycarbonate light fittings don't allow hydrocarbons

Les luminaires de polycarbonate ne supportent pas les hydrocarbures

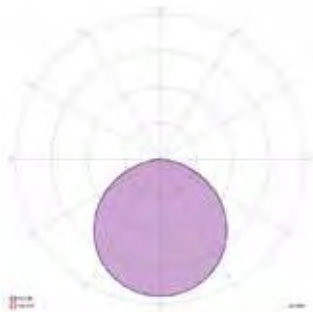

Ref.	Potencia Watts <i>Puissance</i>	Emisión Light emission <i>Intensité lumineuse</i>	Largo Length <i>Longueur</i>	Ancho Wide <i>Large</i>	Embalaje Packaging <i>Carton</i>	Raee European recyclable <i>Ecotaxe</i>	Precio Price <i>Prix</i>
Q0871	18 W	2.440 Lm	900	41	6	0,50 €	137,72 €
Q0872	35 W	4.800 Lm	1.620	41	6	0,50 €	240,99 €
Q0873	41 W	6.100 Lm	1.910	41	6	0,50 €	264,63 €

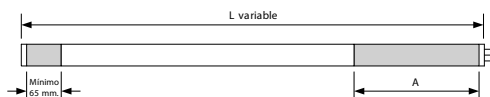

ACCESORIOS / ACCESSORIES / ACCESSOIRES

REF. R0057

21,37 €



Bridas de acero inoxidable
(incremento de precio 2 uds.)
Stainless steel clamps
(price increase 2 units.)
Colliers inox antivandalisme
(plus value de prix 2 uts.)

REF. R0063

35,99 €



Tapas metálicas y racor metálico
(incremento de precio 2 uds.)
**Metallic end caps and
nickel-plated gland**
(price increase 2 units.)
**Embouts métalliques et
presseétoupe**
(plus value de prix 2 uts.)

REF. Q0349

12,21 €



Suspensión con cable de acero
Steel cable suspension
Suspension avec câble en acier



Opción línea continua
Continuous line option
Câblage traversant

3 polos / 3 poles / 3 pôles

REF. R0058

16,22 €

5 polos / 5 poles / 5 pôles

REF. R0064

29,28 €

1.2

Luminarias LED

LED luminaires

Luminaire LED



ES

Las más altas prestaciones en tecnología LED que existen actualmente aplicadas a una luminaria estanca tubular de diseño. Con un grado de protección IP67 que ofrece una protección total contra el polvo y contra la penetración de agua en cantidad perjudicial en el interior de la envolvente sumergida en agua. Además, su punto fuerte es el rendimiento y la cantidad de luz emitida con un mínimo consumo, consiguiendo que la instalación se amortice en un plazo de tiempo menor. Esta estanca es apropiada para multitud de aplicaciones:

- Aplicaciones industriales
- Lugares de pública concurrencia.
- Infraestructuras: puentes, iluminación arquitectónica y monumental con muchas horas de funcionamiento.

Características generales

- Cuerpo luminaria: Policarbonato opal 1 mm de espesor.
- Tapas: Zamak niquelado.
- Reflector: Aluminio brillante.
- Tensión alimentación: Equipo electrónico 220-240 V, 0,15-0,4 A, 50-60 Hz.
- Posibilidad de regulación 1-10 V, touch DIM y DALI.
- Fuente de luz: Módulos LED lineales de alta potencia.
- Vida media estimada: 50.000 horas a temperatura óptima.
- Temperatura de trabajo: De -20° C a +35° C. Temperatura óptima (máximo flujo luminoso): 10° C.
- Ensayo filamento incandescente: 850° C.
- Accesorios: 2 bridas antivandálicas de policarbonato. Prensaestopas metálico.
- Válvulas de circulación de aire estancas.

EN

The highest performance in LED technology that currently exists applied to a design waterproof tubular luminaire. This light fixture has a IP67 protection grade, that offers total protection against dust and water seepage in prejudicial quantities in the interior of the cavity submerged in water. In addition, its strong point is the performance and the quantity of light emitted with a minimum use cost, making the installation able to be depreciated in less time.

This waterproof fixture is appropriate for multitude of applications:

- Industrial applications
- Public crowded places
- Infrastructures: bridges, architectural lighting and monumental with long operating hours.

General characteristics

- Light fitting body: Matte polycarbonate 1 mm thickness.
- End caps: Nickel-plated zamak.
- Reflector: Glossy aluminium.
- Supply voltage: Electronic 220-240 V, 0,15-0,4 A, 50-60 Hz.
- Dimming possibility: 1-10 V, touch DIM and DALI.
- Light source: High power modular LED line.
- Estimated average life: 50.000 hours at optimal temperature.
- Working temperature: From -20° C to +35° C. Optimal temperature (maximum light output): 10° C.
- Glow wire test: 850° C.
- Accessories: 2 vandalism proof polycarbonate clamps, nickel-plated cable gland waterproof air circulation valves (included).

FR

Luminaire étanche tubulaire de design. Avec un degré de protection IP67 qui offre une protection totale face à la poussière et face à l'eau. Il ne permet pas l'entrée d'eau en quantité nuisible à l'intérieur de l'enveloppe submergé dans l'eau.

De plus, son point fort, c'est le rendement et la quantité de lumière émise avec une consommation minimale. Ceci nous permet l'amortissement de l'installation plus rapidement.

Cette étanche est appropriée pour des multiples applications :

- Applications industrielles
- Lieux publics
- Infrastructures : Ponts, éclairage architectural et monumental.

Caractéristiques générales

- Corps du luminaire: Polycarbonate 1 mm d'épaisseur.
- Embouts: Zamak chromé.
- Réflecteur: Aluminium brillant.
- Tension: Electronique 220-240 V, 0,15-0,4 A, 50-60 Hz. Possibilité de régulation 1-10 V, touch DIM et DALI.
- Source de lumière: LED Modules linéaires à haute puissance.
- Estimée de vie moyenne: 50.000 heures à la température optimale.
- Température d'utilisation: De -20° C a +35° C. Température optimale (maximum de flux lumineux): 10° C.
- Essai du fil incandescent: 850° C.
- Accessoires: 2 colliers antivandaliques de fixation en polycarbonate. Presse-étoupe métallique.
- Valves étanches pour circulation de l'air.



Ficha técnica
Technical data
Fiche technique

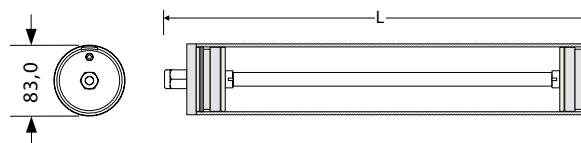

Las luminarias de policarbonato no soportan hidrocarburos

Polycarbonate light fittings don't allow hydrocarbons

Les luminaires de polycarbonate ne supportent pas les hydrocarbures

ALTA POTENCIA / HIGH POWER / HAUTE EFFICACITÉ

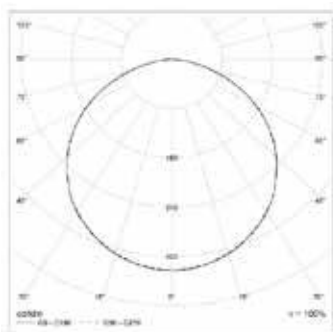

Ref.	Potencia Watts Puissance	Rendimiento Output Rendement	Largo Length Longueur	Raee EU Recyclable tax Ecotaxe	Precio Price Prix
Q0851	18 W	2.400 lm.	713	0,50 €	451,72 €
Q0852	36 W	4.800 lm.	1.323	0,50 €	648,72 €

COMPARATIVA RENDIMIENTOS PERFORMANCE COMPARISON COMPARAISON DES PERFORMANCES

Ref.	Potencia Watts Puissance	Flujo Flux Flux	lm / W	Potencia T5 T5 Output Puissance T5	Rendimiento T5 Output T5 Rendement T5	lm / W T5	+ Rendimiento + Output + Rendement
Q0851	18 W	2.400 lm.	133	14-24 W	1200-1700 lm.	85-72	+ 68 %
Q0852	36 W	4.800 lm.	133	28-54 W	2600-4450 lm.	92-82	+ 53 %

ACCESORIOS / ACCESSORIES / ACCESSOIRES

REF. Q0338

9,63 €



Bridas de acero cincado
Zinc-plated steel clamps
Colliers en acier galvanisé

REF. Q0347

18,21 €



Bridas de acero inoxidable
Stainless steel clamps
Colliers inox antivandalisme

REF. Q0348

7,25 €



Bridas de acero inoxidable de
apertura rápida
Quick opening stainless steel clamps
Colliers inox de ouverture rapide
à grenouillère

REF. Q0349

12,21 €



Suspensión con cable de acero
Steel cable suspension
Suspension avec câble en acier



1.2

Luminarias LED LED luminaires Luminaire LED



Brida
Clamp
Collier

ES

Luminaria autónoma de emergencia LED, con posibilidad de puesta en reposo a distancia (telemando) y apta para montaje en superficie. Su grado de estanqueidad IP67 le confiere protección total contra penetración de polvo y contra penetración de líquidos hasta en inmersión momentánea.

Esta estanca es apropiada para aplicaciones industriales, agrícolas, lugares de pública concurrencia, túneles y áreas de evacuación de infraestructuras públicas.

Gracias a su diseño cilíndrico sus aplicaciones se amplían abarcando instalaciones comerciales, parkings y obras emblemáticas.

Características generales

- Cuerpo luminaria: Policarbonato bicolor de 1 mm de espesor.
- Tapas: A.B.S.
- Reflector: Aluminio brillante.
- Temperatura de trabajo: De 0° C a +45° C.
- Ensayo hilo incandescente: 850° C.
- Batería: 3,6 V; 1500 mAh; 3 celdas de Ni/Cd. Tiempo de carga: 24 horas.
- Fuente de luz: Módulos LED lineales.
- Accesorios: 2 bridas de policarbonato antivandálicas y prensaestopas de poliamida PG-11.



Ficha técnica
Technical data
Fiche technique

EN

Emergency autonomous LED luminaire, with the possibility of remote standby (remote controlled) and fit to be surface mounted. Its waterproofing grade IP67 gives it total protection against dust penetration and liquid penetration until sudden immersion.

This light fitting is appropriated for industrial applications, farming, public places, tunnels and public evacuation areas.

Thanks to its cylindrical design its applications extend including commercial installations, parking lots and important works.

General characteristics

- Light fitting body: Polycarbonate two coloured 1 mm thickness.
- End caps: A.B.S.
- Reflector: Glossy aluminium.
- Working temperature: From 0° C to +45° C.
- Glow wire test: 850° C.
- Battery: 3,6 V; 1500 mAh; 3 Ni/Cd cells; Charging time: 24 hours.
- Light source: Modular LED line
- Accessories: 2 antivandalism polycarbonate clamps and PG-11 polyamide cable gland.

FR

Bloc autonome d'éclairage de sécurité LED, avec la possibilité de mise en repos à distance (télécommande). Installation en surface. Son degré d'étanchéité IP67 offre protection totale face à la poussière et face à la pénétration de liquides pendant des immersions de courte durée de temps.

Cette étanche est conçue pour les applications industrielles, agricoles, lieux publics, tunnels et les zones de sortie de secours des infrastructures publiques.

Grâce à son design cylindrique ses applications sont plus amples, pouvant être installé dans des installations commerciales, parkings et dans des lieux monumentaux.

Caractéristiques générales

- Corps du luminaire: Polycarbonate bicolor de 1 mm de épaisseur.
- Embouts: A.B.S.
- Réflecteur: Aluminium brillant.
- Colliers: Polycarbonate.
- Température d'utilisation: De 0° C a +55° C.
- Essai du fil incandescent: 850° C.
- Batterie: 3,6 V; 1500 mAh; 3 cellule de Ni/Cd; Temps de charge: 24 heures.
- Source lumineuse: LED modules linéaires.
- Accessoires: 2 colliers en polycarbonate antivandalisme et presse-étoupe 68 PG-11.

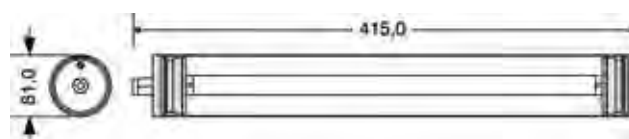

Las luminarias de policarbonato no soportan hidrocarburos

Polycarbonate light fittings don't allow hydrocarbons

Les luminaires de polycarbonate ne supportent pas les hydrocarbures

1 TUBO FLUORESCENTE / 1 LAMP / 1 LAMPE

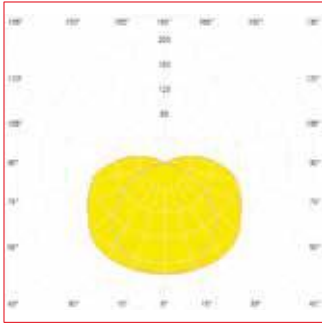

Ref.	Rendimiento Output Rendement	Equipo Equipment Ballast	Autonomia Autonomy Autonomie	Raee EU Recyclable tax Ecotaxe	Precio Price Prix
Q0303	100 lm	●	3 h.	0,50 €	88,55 €
Q0304	100 lm	●	3 h.	0,50 €	78,88 €
Q0305	200 lm	●	1,5 h.	0,50 €	110,92 €
Q0306	200 lm	●	1,5 h.	0,50 €	99,33 €
Q0307	300 lm	●	1 h.	0,50 €	116,76 €
Q0308	300 lm	●	1 h.	0,50 €	104,76 €

● Permanente / permanent / permanent

● No permanente / not permanent / non permanent

ACCESORIOS EMELUX / EMELUX ACCESSORIES / ACCESSOIRES EMELUX

REF. Q0334

9,26 €



Brida de A.B.S. (2 unidades)
A.B.S. clamp (2 units)
Colliers en A.B.S. (2 uts.)

REF. Q0338

9,63 €



Bridas de acero cincado
(incremento de precio 2 uds.)
Zinc-plated steel clamps
(price increase 2 units.)
Colliers en acier galvanisé
(plus value de prix 2 uts.)

REF. Q0348

7,25 €



Bridas de acero inoxidable de apertura rápida
(incremento de precio 2 uds.)
Quick opening stainless steel clamps
(price increase 2 units.)
Colliers inox de ouverture rapide à grenouillère
(plus value de prix 2 uts.)

REF. Q0347

18,21 €



Bridas de acero inoxidable
(incremento de precio 2 uds.)
Stainless steel clamps
(price increase 2 units.)
Colliers inox antivandalisme
(plus value de prix 2 uts.)

REF. Q0349

12,21 €



Suspensión con cable de acero
Steel cable suspension
Suspension avec câble en acier

REF. Q0339

37,41 €



Tapas metálicas y racor metálico
(incremento de precio 2 uds.)
Metallic end caps and nickel-plated gland
(price increase 2 units.)
Embouts et presse-étoupe métallique
(plus value de prix 2 uts.)

1.3

Luminarias LED LED luminaires Luminaires LED



ES

Esta luminaria posee un índice de protección IP65, lo que la hace apropiada para ser instalada en locales húmedos y en exterior. Además, esta luminaria tiene el marcado F que posibilita el montaje sobre superficies normalmente inflamables.

Características generales

- Cuerpo luminaria: A.B.S. de alta temperatura.
- Difusor: Policarbonato opal.
- Chasis interno: Aluminio.
- Corriente: 0.09-0.6 A.
- Tensión de alimentación: 220-240V - 50-60 Hz
- Fuente de luz: Módulos LED 50.000 horas vida (25°C).
- Aislamiento eléctrico: Clase I / Clase II (bajo demanda).
- Temperatura de trabajo: de -20°C a +35°C
- Según norma: EN 60598-1.
- Accesorios: Pasacables estanco y piezas de acero de sujeción a techo.
- Cierres: Grapas de cierre de policarbonato irrompible.

EN

This light fitting has an IP65 protection rating making it suitable for installation in humid environments and outdoors. In addition, since this is a grade F light fixture so it can be mounted on normally flammable surfaces.

General characteristics

- Light fitting body: High temperature ABS.
- Diffuser: Opal Polycarbonate.
- Internal frame: Aluminium.
- Current: 0.09-0.6 A.
- Power source: 220-240V 50-60Hz.
- Light source: LED modules with 50,000 hours lifespan (25°C).
- Electrical insulation: Class I / Class II (upon request).
- According to standard: EN 60598-1.
- Accessories included: Sealed grommets Steel ceiling fixing elements.
- Fasteners: Unbreakable polycarbonate closing clips. Optional stainless steel clips.

FR

L'indice de protection IP65 de ce luminaire le rend apte à une installation dans des locaux humides ainsi qu'à l'extérieur. Ce luminaire marqué F est apte au montage sur des surfaces normalement inflammables.

Caractéristiques générales

- Corps du luminaire: ABS haute température.
- Diffuseur: Polycarbonate opale.
- Châssis interne: Aluminium.
- Courant: 0,09-0,6 A.
- Tension d'alimentation: 220-240 V, 50-60 Hz.
- Source de lumière: Modules LED, durée de vie 50 000 heures (25 °C).
- Isolation électrique: Classe I / Classe II (sur demande).
- Température d'utilisation: -20 °C à +35 °C.
- Selon norme: EN 60598-1.
- Accessoires fournis: Passe-câble étanche. Pattes de fixation au plafond en acier.
- Éléments de fermeture: Clips de fermeture en polycarbonate incassable. Clips acier inox en option.



Ficha técnica
Technical data
Fiche technique

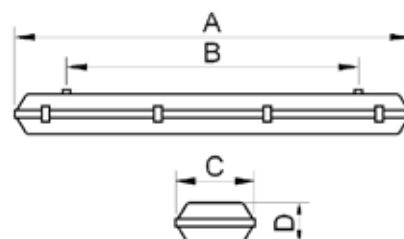

DIMENSIONES / DIMENSIONS / DIMENSIONS

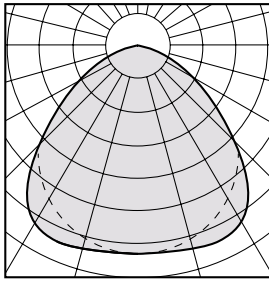

Ref.	Potencia Watts Puissance	Emisión Light emission Intensité lumineuse	A (mm)	B (mm)	C (mm)	d (mm)	Nº Cierres Fasteners Fermetures	Precio Price Prix
Q0874	25 W	3.800 lm.	664	260	160	110	6	180,76 €
Q0875	51 W	7.600 lm.	1.274	650	160	110	8	280,66 €
Q0876	64 W	9.500 lm.	1.575	650	160	110	12	350,96 €

De forma estándar los módulos led son de 4000°K de temperatura de color. Es posible solicitar otras temperaturas de color bajo pedido.

Otras configuraciones de potencia y rendimiento, a consultar.

Disponibles equipos de emergencia para 1 y 3 horas, bajo demanda.

The LED modules have a colour temperature of 4000°K as standard. Other colour temperature options are available on request.

Please ask about other power and performance configurations.

1 and 3 hour emergency kits are available on request.

Le standard de température de couleur des modules LED est de 4 000 °K. D'autres températures de couleur sont disponibles sur demande.

Pour d'autres paramètres de puissance et de rendement, prière de nous consulter.

Appareils d'éclairage de secours de 1 h ou 3 h disponibles sur demande.

ACCESORIOS PISTON / PISTON ACCESSORIES / ACCESSOIRES PISTON

REF. S2150

0,70 €



Grapa de acero inoxidable
Stainless steel clip
Clip acier inox

REF. S2151

2,16 €



Sujeción a carril DELTA
Delta rail fastening
Platine de fixation sur rail DELTA

REF. SCLA2

23,80 €



CLASE II

Posibilidad de Clase II
Available for Class II
Possibilité de Classe II

MONTAJE DE LA LUMINARIA / LAMP ASSEMBLY / MONTAGE DU LUMINAIRE

La luminaria PISTON de AIRFAL ofrece la posibilidad de ser instalada directamente a techo o fijarse a éste mediante carril de aluminio o chapa.

The AIRFAL PISTON light fitting can be fitted either directly onto the ceiling or attached by means of alu-minium rails or metal plates.

Le luminaire PISTON AIRFAL peut être installé directement au plafond ou sur un rail en aluminium ou en tôle fixé lui-même au plafond.

Instalación directamente a techo / Fitted directly onto the ceiling / Installation directe au plafond

Mediante piezas de sujeción troqueladas que se incluyen en la luminaria.

Using die-cut fasteners included in the light fitting.

À l'aide de pattes de fixation fournies avec le luminaire.

Instalación a carril / Fitted on rail / Fixation sur le rail

Mediante 2 uds. del accesorio P0126 por cada luminaria, a través de las cuales se pueden montar luminarias a los siguientes perfiles diferentes de carril, cada uno de ellos en longitudes de 3.070 mm y 3.700 mm.

By using two P0126 accessory units per light fitting in order to mount light fittings on the following different rail profiles, each of them on 3.070 mm and 3.700 mm lengths.

À l'aide de 2 unités de l'accessoire P0126 par luminaire, qui permettent de le fixer sur les rails aux profilés différents présentés ci-dessous, chacun étant disponible aux longueurs de 3 070 mm et 3 700 mm.

Carriles de aluminio / Aluminium rails / Rails en aluminium

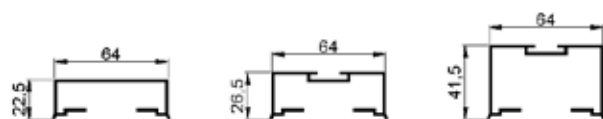

Carriles de chapa / Metal plate rails / Rails en tôle

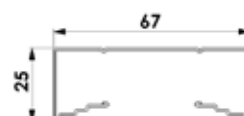

1.4

Luminarias LED
LED luminaires
Luminaire LED

	Luminarias Luminaire Luminaire
Accesos de pública concurrencia Crowded public access Accès publics à forte densité	PEGASO
Aeropuertos / estaciones de tren, metro Airport / Railway station Aéroports / stations de train, métro	THUNDER, PEGASO, SILVER, ORION, MUSTANG
Aplicaciones que requieran un bloque autónomo de emergencia y que por cuestiones estéticas o de resistencia demanden una luminaria tubular con tecnología led Applications that require an autonomous emergency block and that for aesthetics or resistance reasons demand a tubular luminaire with led technology Établissements où un éclairage de sécurité est obligatoire et l'esthétique ou besoin de résistante demandent un luminaire tubulaire avec la technologie led	EMELUX LED
Estancias en litorales y zonas costeras Stays in coastlines and coastal areas Zones de côte et du littoral	THUNDER, SILVER, ORION, MUSTANG
Almacenes y áreas de carga y descarga Loading and unloading warehouses Zones de chargement et déchargement	THUNDER, SILVER, ORION, PISTON, MUSTANG
Aplicaciones navales / Naval applications / Applications nautiques	MUSTANG
Hoteles / Hotels / Hôtels	PEGASO
Terrazas y espacios de ocio abiertos Terraces and leisure open spaces Terrasses et espace loisirs	EXCALIBUR, WALED
Fachadas / Facades / Façades	EXCALIBUR, WALED, EXCALIBUR, WALED
Mobiliario exterior / Outdoor furniture / Mobilier extérieur	EXCALIBUR
Garajes de edificios privados, comunidades de vecinos, cuartos de bombas Private building garages, neighborhoods, pump rooms Garages privés, syndicat de propriétaires, Chambre pour les pompes	PISTON
Grandes esculturas o monumentos históricos Great sculptures or historic monuments Grandes sculptures où monuments historiques	EXCALIBUR , WALED
Naves industriales y fábricas con producción en exterior Industrial warehouses and factories with exterior production Industrie et emplacements de fabrication en extérieur	THUNDER, SILVER, ORION, WALED, PISTON, MUSTANG
Invernaderos / Greenhouses / Serres	THUNDER, SILVER, ORION, MUSTANG
Oficinas / Offices / Bureaux	PEGASO
Piscinas / SPA Swimming pools / SPA Piscines / SPA	THUNDER, SILVER, ORION, EXCALIBUR, WALED, MUSTANG
Puentes / Bridges / Ponts	THUNDER, SILVER, ORION, EXCALIBUR, WALED, MUSTANG
Parkings y pasos subterráneos Parkings and underpasses Parkings et les passages souterrains	THUNDER, SILVER, ORION, MUSTANG
Trasteros / Storage rooms / Entrepôts	PISTON
Zonas de especial riesgo de actos vandálicos Areas with special risk of vandal acts Zones spécialement exposés au vandalisme	MUSTANG
Zonas deportivas / Sport areas / Terrains de sport	THUNDER, PEGASO, SILVER, ORION, WALED, MUSTANG



Luminaria personalizada tubular opal con módulos LED IP68 Meandro de Aranzadi, Pamplona, España
Custom tubular opal luminaire with LED modules IP68 Aranzadi Meander, Pamplona, Spain
Luminaire creation sur mesure de tubulaire opale avec des modules LED IP68 Méandre d'Aranzadi, Pampelune, Espagne

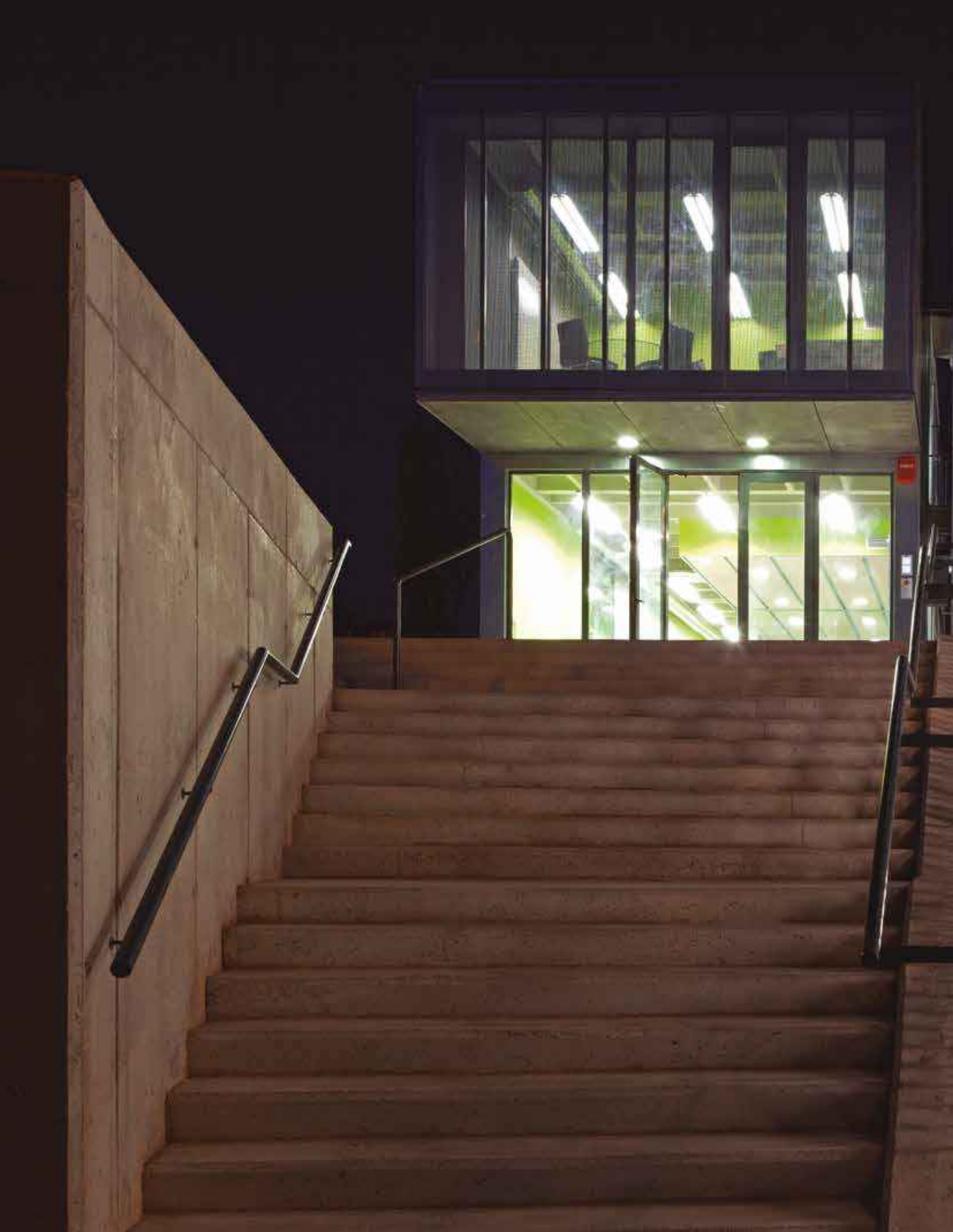

TR3

Residencia Estudiantes, Manresa, España. Luminaria TR3, por el arquitecto Xavier Tragant

Student housing, Manresa, Spain. TR3 luminaire, by Xavier Tragant architect

Foyer d'étudiants, Manresa, Espagne. TR3 luminaire, Xavier Tragant architecte



TR3



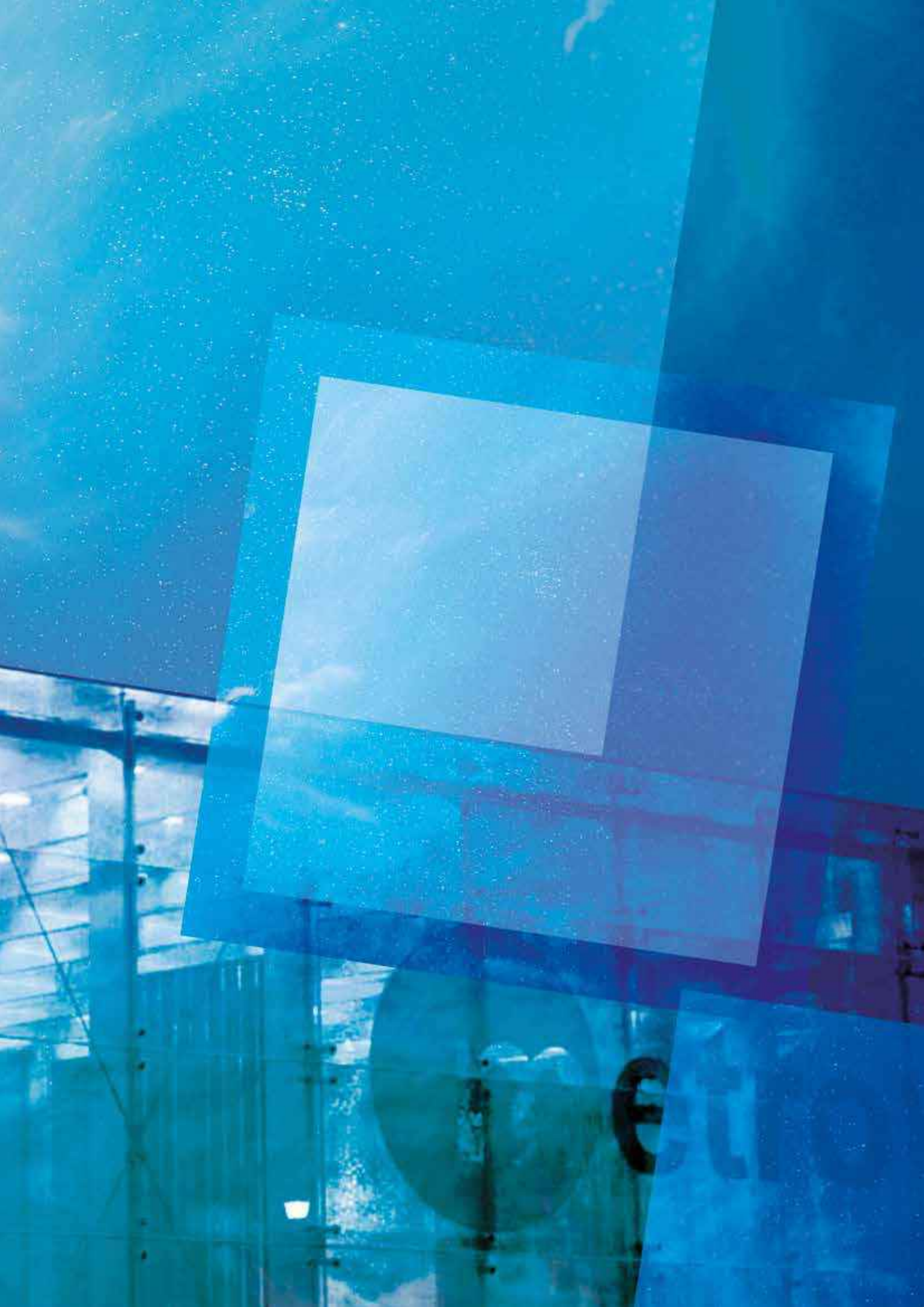



Residencia Estudiantes, Manresa, España. Luminaria TR3, por el arquitecto Xavier Tragant
Student housing, Manresa, Spain. TR3 luminaire, by Xavier Tragant architect
Foyer d'étudiants, Manresa, Espagne. TR3 luminaire, Xavier Tragant architecte



LUMINARIAS ESTANCAS

WATERPROOF LUMINAIRES

LUMINAIRES ÉTANCHES

2.1	IP68	TR1	42
		Rinox 	46
		Chemical	52
		Resist 	56
		Tunnel 	64
		Oven	70
		TR2 	72
2.2	IP67	TR3 	80
		Reflectores / Reflectors / <i>Reflecteurs</i>	95
		TR4 	98
		Compact	106
		Emelux	108
2.3	IP65	Supra	110
		Supra T5	112
		Supra 	114
		Modelo M / Model M	116
2.4	IP42	Modelo M / Model M	120
2.5		Cuadro de aplicaciones Applications chart <i>Tableau d'applications</i>	124



TR3 personalizada / TR3 custom made / TR3 creation sur mesure

Estadio de Fútbol Nuevo San Mamés, Bilbao, España

[New San Mamés Football Stadium, Bilbao, Spain](#)

Nouveau Stade de Football de San Mamés, Bilbao, Espagne



TR3 personalizada / TR3 custom made / TR3 creation sur mesure

Estadio de Fútbol Nuevo San Mamés, Bilbao, España

[New San Mamés Football Stadium, Bilbao, Spain](#)

Nouveau Stade de Football de San Mamés, Bilbao, Espagne



2.1

Luminarias estancas

Waterproof luminaires

Luminaires étanches



Brida
Clamp
Collier

ES

Esta luminaria está diseñada siguiendo criterios estéticos de carácter industrial. La incorporación de las lamas de alto rendimiento en este modelo la convierte en una luminaria adecuada para espacios interiores. Destinada a instalaciones donde se requiere alta eficacia y elevado confort visual, resulta una estancia apropiada para multitud de aplicaciones arquitectónicas tales como:

- Iluminación general de oficinas
- Despachos
- Espacios públicos
- Salas de presentación
- Locales comerciales
- Sucursales bancarias

Características generales

- Cuerpo luminaria: Policarbonato anti-UV 2 mm de espesor.
- Tapas: ABS V0 autoextinguible.
- Reflector: Aluminio brillante con lamas aluminio de alto brillo.
- Temperatura de trabajo: De -20° C a +55° C.
- Ensayo filamento incandescente: 960° C.
- Accesorios: 2 bridas de sujeción de acero inoxidable de apertura rápida y prensaestopas PG-11 (incluidos).

EN

This light fitting has been designed for use in industrial settings. The incorporation of high output filaments in this model renders it suitable for indoor use.

Intended for installations requiring high efficiency and visual comfort, this waterproof model is appropriate for numerous architectural uses such as:

- General office lighting
- Offices
- Public areas
- Presentation rooms
- Business premises
- Bank branches

General characteristics

- Light fitting body: Anti-UV polycarbonate 2 mm thickness.
- End caps: ABS V0 self-extinguishing.
- Reflector: Glossy aluminium with high brilliant aluminium louvre.
- Working temperature: From -20° C to +55° C.
- Glow wire test: 960° C.
- Accessories: 2 quick opening stainless steel clamps and PG-11 polyamide cable gland (included).

FR

TR1, un luminaire adapté aux espaces intérieurs, muni d'une grille permettant de contrôler la diffusion de la lumière. Son design répond aux exigences de l'esthétique industrielle. Ce luminaire étanche apporte un grand confort visuel et un excellent rendement dans les installations les plus diverses :

- Éclairage général d'espaces de bureaux
- Bureaux particuliers
- Espaces publics
- Salles de réunion
- Locaux commerciaux
- Agences bancaires.

Caractéristiques générales

- Corps du luminaire: Polycarbonate anti-UV 2 mm d'épaisseur.
- Embouts: ABS V0 auto-extinguible.
- Réflecteur: Aluminium brillant avec grille basse luminance en aluminium grand brillant.
- Température d'utilisation: De -20° C a +55° C.
- Essai du fil incandescent: 960° C.
- Accessoires: 2 colliers de fixation inoxydable d'ouverture rapide à grenouillère et presse-étoupe métallique (inclus).



Ficha técnica
Technical data
Fiche technique

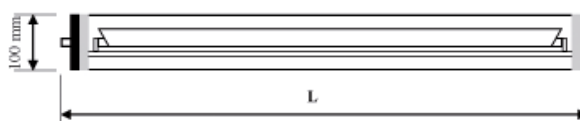

Las luminarias de policarbonato no soportan hidrocarburos

Polycarbonate light fittings don't allow hydrocarbons

Les luminaires de polycarbonate ne supportent pas les hydrocarbures.

1 TUBO FLUORESCENTE / 1 LAMP / 1 LAMPE

G5
T5

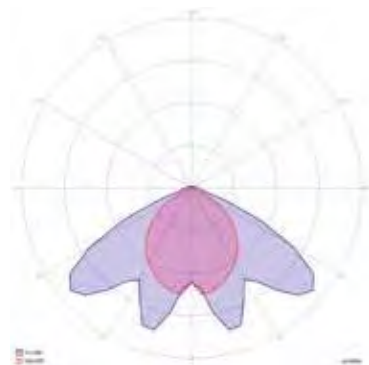

- Electrónica / Electronic / Électronique
- Regulable / Dimmable / Gradable

Ref.	Potencia Watts Puissance	Equipo Equipment Ballast	Largo Length Longueur	Raee EU Recyclable tax Ecotaxe	Precio Price Prix
Alta Eficacia / High Efficiency / Haute Efficacité					
Q0701	14 W	●	675	0,50 €	286,88 €
Q0710	14 W	●	675	0,50 €	326,88 €
Q0702	21 W	●	970	0,50 €	334,33 €
Q0711	21 W	●	970	0,50 €	374,33 €
Q0703	28 W	●	1.276	0,50 €	376,88 €
Q0712	28 W	●	1.276	0,50 €	416,88 €
Q0704	35 W	●	1.578	0,50 €	417,43 €
Q0713	35 W	●	1.578	0,50 €	457,43 €
Alto Rendimiento / High Output / Flux Élevé					
Q0705	24 W	●	675	0,50 €	286,88 €
Q0714	24 W	●	675	0,50 €	326,88 €
Q0706	39 W	●	970	0,50 €	334,33 €
Q0715	39 W	●	970	0,50 €	374,33 €
Q0707	49 W	●	1.578	0,50 €	417,43 €
Q0716	49 W	●	1.578	0,50 €	457,43 €
Q0708	54 W	●	1.276	0,50 €	376,88 €
Q0717	54 W	●	1.276	0,50 €	416,88 €
Q0709	80 W	●	1.578	0,50 €	420,55 €
Q0718	80 W	●	1.578	0,50 €	460,55 €

2 TUBOS FLUORESCENTES / 2 LAMPS / 2 LAMPES



- Electrónica / Electronic / Électronique
- Regulable / Dimmable / Gradable

Ref.	Potencia Watts Puissance	Equipo Equipment Ballast	Largo Length Longueur	Raee EU Recyclable tax Ecotaxe	Precio Price Prix
Alta Eficacia / High Efficiency / Haute Efficacité					
Q0719	14 W	●	675	0,50 €	299,87 €
Q0728	14 W	●	675	0,50 €	339,87 €
Q0720	21 W	●	970	0,50 €	345,27 €
Q0729	21 W	●	970	0,50 €	385,27 €
Q0721	28 W	●	1.276	0,50 €	424,94 €
Q0730	28 W	●	1.276	0,50 €	464,94 €
Q0722	35 W	●	1.578	0,50 €	439,77 €
Q0731	35 W	●	1.578	0,50 €	479,77 €
Alto Rendimiento / High Output / Flux Élevé					
Q0723	24 W	●	675	0,50 €	299,87 €
Q0732	24 W	●	675	0,50 €	339,87 €
Q0724	39 W	●	970	0,50 €	345,27 €
Q0733	39 W	●	970	0,50 €	385,27 €
Q0725	49 W	●	1.578	0,50 €	439,77 €
Q0734	49 W	●	1.578	0,50 €	479,77 €
Q0726	54 W	●	1.276	0,50 €	385,50 €
Q0735	54 W	●	1.276	0,50 €	425,50 €



2.1

Luminarias estancas
Waterproof luminaires
Luminaire étanches



Brida
Clamp
Collier

OPCIÓN CHAPA MICROPERFORADA CUBREEQUIPOS
MICROPERFORATED BALLAST-COVERING STEEL PLATE OPTION
OPTION GRILLE MICROPERFORÉE CACHE-APPAREILLAGE

Potencia Watts Puissance	Aumento precio Price increase Plus value
14-24 W	19,00 €
21-39 W	24,00 €
28-54 W	31,00 €
35-49-80 W	37,00 €

Ref luminaria + "C". Ej.: Q0714C
Light fitting ref + "C". Ex.: Q0714C
Ref luminaire + "C". Ex.: Q0714C



2.1

Luminarias estancas Waterproof luminaires Luminaire étanches



ANTIVANDÁLICA / ANTIVANDALISM / ANTIVANDALISME

ES

Su cuerpo de policarbonato de 3,5 mm de espesor le da una extraordinaria resistencia contra impactos, obteniendo un índice de protección IK10.

La envolvente se adapta perfectamente a condiciones adversas de polvo y humedad gracias a su excelente estanqueidad, obteniendo un grado de protección IP68, pudiendo ser sumergida a 2 metros de profundidad.

Disponibles versiones altas temperaturas.

Características generales

- Cuerpo luminaria: Policarbonato anti-UV 3,5 mm de espesor.
- Tapas: Inox cierre con tornillo.
- Reflector: Aluminio brillante.
- Temperatura de trabajo: De -20° C a +55° C.
- Ensayo filamento incandescente: 960° C.
- Accesorios: 2 bridas de acero inoxidable de apertura rápida y racor metálico PG-11 (incluidos).

EN

Its 3,5mm. polycarbonate body gives it extraordinary protection against impacts, giving it an IK10 protection rating.

The casing is perfectly suited to dusty or wet conditions. Thanks to its excellent protection rating IP68, allows it to be submerged up to 2 meters.

Available in high temperature version.

General characteristics

- Light fitting body: Anti-UV polycarbonate 3,5 mm thickness.
- End caps: Stainless steel close by steel screw.
- Reflector: Glossy aluminium.
- Working temperature: From -20° C to +55° C.
- Glow wire test: 960° C.
- Accessories: 2 fast opening stainless steel clamps and PG-11 nickel-plated cable gland (included).

FR

Son corps en polycarbonate de 3,5 mm d'épaisseur lui confère une extraordinaire résistance aux chocs, obtenant ainsi un degré de protection IK10.

L'enveloppe s'adapte parfaitement aux conditions difficiles de poussière et d'humidité grâce à son excellente étanchéité, obtenant un degré de protection IP68 et pouvant être immergée à 2 mètres de profondeur.

Disponible en version compensé.

Caractéristiques générales

- Corps du luminaire: Polycarbonate anti-UV 3,5 mm d'épaisseur.
- Embouts: Acier inox avec fermeture par vis.
- Réflecteur: Aluminium brillant.
- Température d'utilisation: De -20° C à +55° C.
- Essai du fil incandescent: 960° C.
- Accessoires: 2 colliers o inox d'ouverture rapide à grenouillère et presse-étoupe métallique PG-11 (inclus).



Ficha técnica
Technical data
Fiche technique



Las luminarias de policarbonato no soportan hidrocarburos

Polycarbonate light fittings don't allow hydrocarbons

Les luminaires de polycarbonate ne supportent pas les hydrocarbures

1 TUBO FLUORESCENTE / 1 LAMP / 1 LAMPE



Ref.	Potencia Watts <i>Puissance</i>	Equipo Equipment <i>Ballast</i>	Largo Length <i>Longueur</i>	Raee EU Recyclable tax <i>Ecotaxe</i>	Precio Price <i>Prix</i>
Q0511	18 W	●	683	0,50 €	234,61 €
Q0512	18 W	●	683	0,50 €	274,61 €
Q0513	36 W	●	1.293	0,50 €	296,15 €
Q0514	36 W	●	1.293	0,50 €	336,15 €
Q0515	58 W	●	1.593	0,50 €	320,93 €
Q0516	58 W	●	1.593	0,50 €	360,93 €

● Electrónica / *Electronic* / *Électronique*● Regulable / *Dimmable* / *Gradable*

2 TUBOS FLUORESCENTES / 2 LAMPS / 2 LAMPES



Ref.	Potencia Watts <i>Puissance</i>	Equipo Equipment <i>Ballast</i>	Largo Length <i>Longueur</i>	Raee EU Recyclable tax <i>Ecotaxe</i>	Precio Price <i>Prix</i>
Q0517	18 W	●	683	0,50	244,10 €
Q0518	18 W	●	683	0,50	284,10 €
Q0519	36 W	●	1.293	0,50	305,39 €
Q0520	36 W	●	1.293	0,50	345,39 €
Q0521	58 W	●	1.593	0,50	335,36 €
Q0522	58 W	●	1.593	0,50	375,36 €

● Electrónica / *Electronic* / *Électronique*● Regulable / *Dimmable* / *Gradable*



2.1

Luminarias estancas Waterproof luminaires Luminaires étanches

ANTIVANDÁLICA / ANTIVANDALISM / ANTIVANDALISME

1 TUBO FLUORESCENTE / 1 LAMP / 1 LAMPE

G5
T5

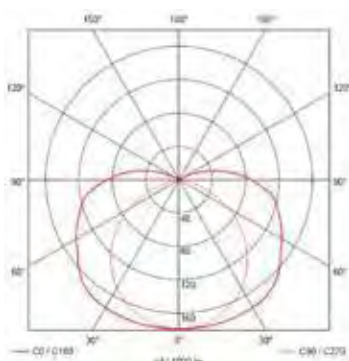

Ref.	Potencia Watts Puissance	Equipo Equipment Ballast	Largo Length Longueur	Raee EU Recyclable tax Ecotaxe	Precio Price Prix
Alta Eficacia / High Efficiency / Haute Efficacité					
Q0525	14 W	●	643	0,50 €	236,94 €
Q0526	14 W	●	643	0,50 €	276,95 €
Q0527	21 W	●	942	0,50 €	264,59 €
Q0528	21 W	●	942	0,50 €	304,59 €
Q0529	28 W	●	1.242	0,50 €	294,43 €
Q0530	28 W	●	1.242	0,50 €	334,43 €
Q0531	35 W	●	1.542	0,50 €	323,66 €
Q0532	35 W	●	1.542	0,50 €	363,66 €
Alto Rendimiento / High Output / Flux Élevé					
Q0533	24 W	●	643	0,50 €	236,08 €
Q0534	24 W	●	643	0,50 €	276,08 €
Q0535	39 W	●	942	0,50 €	264,59 €
Q0536	39 W	●	942	0,50 €	304,59 €
Q0537	49 W	●	1.542	0,50 €	323,66 €
Q0538	49 W	●	1.542	0,50 €	363,66 €
Q0539	54 W	●	1.242	0,50 €	294,43 €
Q0540	54 W	●	1.242	0,50 €	334,43 €
Q0541	80 W	●	1.542	0,50 €	340,23 €
Q0542	80 W	●	1.542	0,50 €	380,23 €

● Electrónica / Electronic / Électronique
● Regulable / Dimmable / Gradable

2 TUBOS FLUORESCENTES / 2 LAMPS / 2 LAMPES

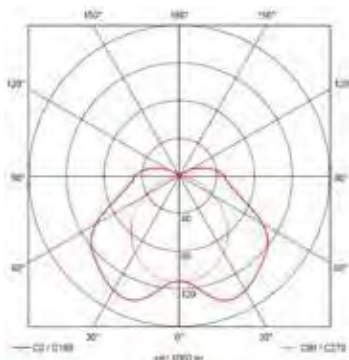

Ref.	Potencia Watts Puissance	Equipo Equipment Ballast	Largo Length Longueur	Raee EU Recyclable tax Ecotaxe	Precio Price Prix
Alta Eficacia / High Efficiency / Haute Efficacité					
Q0543	14 W	●	643	0,50 €	248,46 €
Q0544	14 W	●	643	0,50 €	288,46 €
Q0545	21 W	●	942	0,50 €	277,37 €
Q0546	21 W	●	942	0,50 €	317,37 €
Q0547	28 W	●	1.242	0,50 €	307,97 €
Q0548	28 W	●	1.242	0,50 €	347,97 €
Q0549	35 W	●	1.542	0,50 €	334,02 €
Q0550	35 W	●	1.542	0,50 €	374,02 €
Alto Rendimiento / High Output / Flux Élevé					
Q0551	24 W	●	643	0,50 €	248,46 €
Q0552	24 W	●	643	0,50 €	288,46 €
Q0553	39 W	●	942	0,50 €	277,37 €
Q0554	39 W	●	942	0,50 €	317,37 €
Q0555	49 W	●	1.542	0,50 €	334,02 €
Q0556	49 W	●	1.542	0,50 €	374,02 €
Q0557	54 W	●	1.242	0,50 €	307,97 €
Q0558	54 W	●	1.242	0,50 €	347,97 €

● Electrónica / Electronic / Électronique
● Regulable / Dimmable / Gradable

ANTIVANDÁLICA ALTAS TEMPERATURAS

ANTIVANDALISM HIGH TEMPERATURES

ANTIVANDALISME HAUTES TEMPÉRATURES



ES

Características generales

- Cuerpo luminaria: Policarbonato anti-UV 3,5 mm de espesor.
- Tapas: Acero inoxidable cierre mediante tornillo.
- Reflector: Aluminio brillante.
- Temperatura de trabajo: De -13° C a +85° C.
- Ensayo filamento incandescente: 960° C.
- Accesorios: 2 bridas de acero inoxidable de apertura rápida y racor metálico PG-11 (incluidas).

EN

General characteristics

- Light fitting body: Anti-UV polycarbonate 3,5 mm thickness.
- End caps: Stainless steel close by steel screw.
- Reflector: Glossy aluminium.
- Working temperature: From -13° C to +85° C.
- Glow wire test: 960° C.
- Accessories: 2 fast opening stainless steel clamps and PG-11 nickel-plated cable gland (included).

FR

Caractéristiques générales

- Corps du luminaire: Polycarbonate anti-UV 3,5 mm. de épaisseur.
- Embouts: Acier inox avec fermeture par vis.
- Réflecteur: Aluminium brillant.
- Température d'utilisation: De -13° C à +85° C.
- Essai du fil incandescent: 960° C.
- Accessoires: 2 colliers inox d'ouverture rapide à grenouillère et presse-étoupe métallique PG-11 (inclus).

G 13
T8

Ref.	Potencia Watts Puissance	Equipo Equipment Ballast	Largo Length Longueur	Raee EU Recyclable tax Ecotaxe	Precio Price Prix
Q0559	1 x 18 W	●	683	0,50 €	253,87 €
Q0560	1 x 36 W	●	1.293	0,50 €	323,36 €
Q0561	1 x 58 W	●	1.593	0,50 €	372,44 €
Q0562	2 x 18 W	●	683	0,50 €	261,21 €
Q0563	2 x 36 W	●	1.293	0,50 €	356,85 €
Q0564	2 x 58 W	●	1.593	0,50 €	426,88 €

● Alto factor / High factor / Compensé

2.1

Luminarias estancas Waterproof luminaires Luminaires étanches



Brida
Clamp
Collier

ES

Características generales

- Cuerpo luminaria: Policarbonato anti-UV 3,5 mm de espesor.
- Tapas: Acero inoxidable cierre mediante tornillo.
- Reflector: Aluminio brillante.
- Temperatura de trabajo: Consultar al fabricante del tubo LED.
- Ensayo filamento incandescente: 960° C.
- Accesorios: 2 bridas de acero inoxidable de apertura rápida y racor metálico PG-11 (incluidas).

EN

General characteristics

- Light fitting body: Anti-UV polycarbonate 3,5 mm thickness.
- End caps: Stainless steel close by screw.
- Reflector: Glossy aluminium.
- Working temperature: Ask the LED tube manufacturer.
- Glow wire test: 960° C.
- Accessories: 2 fast opening stainless steel clamps and PG-11 nickel-plated cable gland (included).

FR

Caractéristiques générales

- Corps du luminaire: Polycarbonate anti-UV 3,5 mm. dé épaisseur.
- Embouts: Acier inox avec fermeture par vis.
- Réflecteur: Aluminium brillant.
- Température d'utilisation: Consultez au fabricant du tube LED
- Essai du fil incandescent: 960° C.
- Accessoires: 2 colliers inox d'ouverture rapide à grenouillère et presseétoupe métallique PG-11 (inclus).

1 TUBO LED / 1 LED TUBE / 1 TUBE LED

G 13
T8

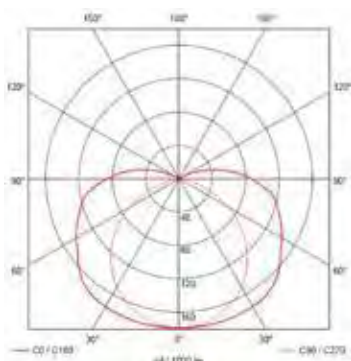

Ref.	Longitud Tubo Tube Length Longueur Tube	Longitud Luminaria Fitting Length Longueur Luminaire	Raee EU Recyclable tax Ecotaxe	Precio Price Prix
Q0511L	600 mms.	683 mms.	0,50 €	224,61 €
Q0523L	900 mms.	1.089 mms.	0,50 €	254,38 €
Q0513L	1.200 mms.	1.293 mms.	0,50 €	284,15 €
Q0515L	1.500 mms.	1.593 mms.	0,50 €	308,93 €

2 TUBOS LED / 2 LED TUBES / 2 TUBES LED

Ref.	Longitud Tubo Tube Length Longueur Tube	Longitud Luminaria Fitting Length Longueur Luminaire	Raee EU Recyclable tax Ecotaxe	Precio Price Prix
Q0517L	600 mms.	683 mms.	0,50 €	232,10 €
Q0524L	900 mms.	1.089 mms.	0,50 €	262,75 €
Q0519L	1.200 mms.	1.293 mms.	0,50 €	293,39 €
Q0521L	1.500 mms.	1.593 mms.	0,50 €	323,36 €



Ficha técnica
Technical data
Fiche technique





OPAL / MATTE / OPALE



Ref luminaria + "O". Ej.: Q0511O
 Light fitting ref + "O". Ex.: Q0511O
 Ref luminaire + "O". EX.: Q0511O

Potencia Watts Puissance	Aumento precio Price increase Plus value
18 W	2,73 €
36 W	5,23 €
58 W	6,41 €
14-24 W	2,58 €
21-39 W	3,83 €
28-54 W	5,00 €
35-49-80 W	6,25 €

ACCESORIOS RINOX / RINOX ACCESSORIES / ACCESSOIRES RINOX

REF. Q0656

22,50 €



Bridas de acero inoxidable
 (incremento de precio 2 uds.)
Stainless steel clamps
 (price increase 2 units.)
Colliers inox antivandalisme
 (plus value de prix 2 uts.)

REF. Q0153

9,30 €



Brida de policarbonato
 antivandánica (2 unidades)
Antivandalic polycarbonate
 clamp (2 units)
Colliers en polycarbonate
 antivandalisme (2 uts.)

REF. Q0159

12,00 €



Bridas de acero cincado
 (incremento de precio 2 uds.)
Zinc-plated steel clamps
 (price increase 2 units.)
Colliers en acier galvanisé
 (plus value de prix 2 uts.)

Reflectores especiales en
 página 95

Special reflectors in
 page 95

Réflecteurs spéciaux en
 page 95

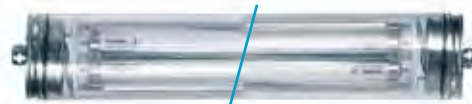

Opción línea continua
 Continuous line option
 Câblage traversant

3 polos / 3 poles / 3 pôles

REF. Q0565

23,09 €

5 polos / 5 poles / 5 pôles

REF. Q0566

35,35 €



2.1

Luminarias estancas Waterproof luminaires Luminaires étanches



Brida
Clamp
Collier



ES

Esta luminaria está indicada en aquellos lugares con condiciones de trabajo o ambientales que hagan preciso el uso de materiales resistentes a ataques químicos, o con requerimientos de limpieza muy profundos. Como ejemplos:

- Laboratorios farmacéuticos o químicos.
- Plantas de procesamiento de alimentos.
- Fábricas de piensos.
- Máquinas de corte o fresado con proyección de viruta y taladrina.
- Instalaciones hospitalarias.
- Bajo pedido, se puede fabricar con componentes especiales resistentes al cloro.

Versión altas temperaturas, consultar al departamento técnico.

Características generales

- Cuerpo luminaria: Vidrio de borosilicato de 90 x 5 mms.
- Tapas: Acero inoxidable. Cierre mediante tornillo con junta estanca.
- Reflector: Aluminio brillo sobre chasis en acero galvanizado.
- Temperatura de trabajo: De -20° C a +40° C.
- Accesorios: 2 bridas en acero inoxidable con protección de caucho. Prensaestopas metálicos incluidos.

EN

This light fitting is indicated for places with working or environmental conditions that make necessary the use of chemical resistant materials, or with very deep cleaning requirements.

Examples:

- Chemical or pharmaceutical laboratories.
- Food processing plants.
- Animal feed factories.
- Cutting machines or milling with projection of chip and cutting and coolant oil.
- Hospital installations.
- On request, can be manufactured with chlorine-resistant special components.

High temperatures model, ask for technical department.

General characteristics

- Light fitting body: Borosilicate tempered glass tube of 90 x 5 mms.
- End caps: Stainless steel. Close by screw.
- Reflector: Glossy aluminium on galvanized steel chassis.
- Working temperature: From -20° C to +40° C.
- Accessories: 2 stainless steel clamps with rubber protection and metallic cable gland (included).

FR

Ce luminaire est conçu pour les endroits où les conditions de travail, l'ambiance et les besoin de nettoyage industriel obligent à l'utilisation de matériaux résistants aux attaques chimiques.

Comme par exemple :

- Laboratoires pharmaceutiques et chimiques.
- Industries alimentaires
- Usines d'engrais
- Machines outils, tel que tours et fraiseuses, qui projettent des copeaux et du liquide réfrigérant.
- Sous demande, il est possible fabriquer des composants spéciaux résistants au chlore.

Versión haute température, consultez le département technique.

Caractéristiques générales

- Corps du luminaire: Verre borosilicate.
- Embouts: Acier inoxydable. Fermeture par vis et joint détançhété.
- Réflecteur: Aluminium brillant sur support en acier galvanisé.
- Température d'utilisation: De -20 C a +40° C.
- Accessoires: 2 colliers en acier inoxydable avec protection en caoutchouc. Presse-étoupe métallique (inclus).



Ficha técnica
Technical data
Fiche technique

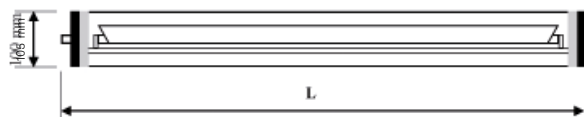

1 TUBO FLUORESCENTE / 1 LAMP / 1 LAMPE

G5
T5



● Electrónica / Electronic / Électronique

Ref.	Potencia Watts Puissance	Equipo Equipment Ballast	Largo Length Longueur	Raee EU Recyclable tax Ecotaxe	Precio Price Prix
Alta Eficacia / High Efficiency / Haute Efficacité					
Q0901	14 W	●	673	0,50 €	442,32 €
Q0902	21 W	●	973	0,50 €	545,26 €
Q0903	28 W	●	1.273	0,70 €	552,28 €
Q0904	35 W	●	1.573	0,70 €	526,57 €
Alto Rendimiento / High Output / Flux Élevé					
Q0905	24 W	●	673	0,50 €	442,32 €
Q0906	39 W	●	973	0,50 €	545,26 €
Q0907	49 W	●	1.573	0,70 €	526,42 €
Q0908	54 W	●	1.273	0,70 €	552,28 €
Q0909	80 W	●	1.573	0,70 €	543,14 €

2 TUBOS FLUORESCENTES / 2 LAMPS / 2 LAMPES



● Electrónica / Electronic / Électronique

Ref.	Potencia Watts Puissance	Equipo Equipment Ballast	Largo Length Longueur	Raee EU Recyclable tax Ecotaxe	Precio Price Prix
Alta Eficacia / High Efficiency / Haute Efficacité					
Q0919	14 W	●	673	0,50 €	447,32 €
Q0920	21 W	●	973	0,50 €	552,27 €
Q0921	28 W	●	1.273	0,70 €	558,91 €
Q0922	35 W	●	1.573	0,70 €	535,55 €
Alto Rendimiento / High Output / Flux Élevé					
Q0923	24 W	●	673	0,50 €	447,32 €
Q0924	39 W	●	973	0,70 €	552,27 €
Q0925	49 W	●	1.573	0,70 €	535,55 €
Q0926	54 W	●	1.273	0,70 €	558,91 €

G13
T8

● Alto factor - Altas temperaturas
● High factor - High temperatures
● Compensé - Hautes températures
● Electrónica / Electronic / Électronique



Ref.	Potencia Watts Puissance	Equipo Equipment Ballast	Largo Length Longueur	Raee EU Recyclable tax Ecotaxe	Precio Price Prix
Q0937	1 x 18 W	●	714	0,50 €	421,72 €
Q0938	1 x 36 W	●	1.324	0,70 €	549,85 €
Q0939	1 x 18 W	●	714	0,70 €	434,80 €
Q0940	1 x 36 W	●	1.324	0,70 €	552,75 €



TR3

Estadio de fútbol del Malecón, Torrelavega, España, por Javier Terán - MMiT arquitectos
[Malecón Football Stadium, Torrelavega, Spain, by Javier Terán - MMiT architects](#)
Stade de Football du Malecón, Torrelavega, Espagne, Javier Terán - MMiT architectes



TR3

Estadio de fútbol del Malecón, Torrelavega, España, por Javier Terán - MMiT arquitectos
[Malecón Football Stadium, Torrelavega, Spain, by Javier Terán - MMiT architects](#)
Stade de Football du Malecón, Torrelavega, Espagne, Javier Terán - MMiT architectes



TR3

Estadio de fútbol del Malecón, Torrelavega, España, por Javier Terán - MMiT arquitectos

[Malecón Football Stadium, Torrelavega, Spain, by Javier Terán - MMiT architects](#)

Stade de Football du Malecón, Torrelavega, Espagne, Javier Terán - MMiT architectes



2.1

Luminarias estancas Waterproof luminaires Luminaires étanches

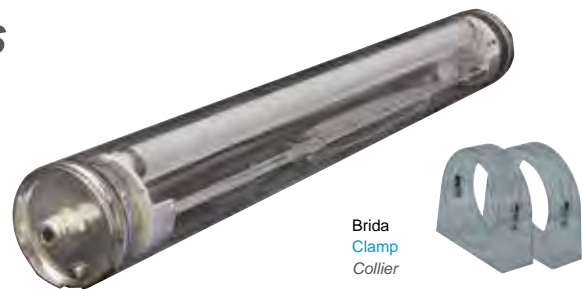

Brida
Clamp
Collier

ANTIVANDÁLICA / ANTIVANDALISM / ANTIVANDALISME

ES

Su cuerpo de policarbonato de 3,5 mm de espesor le da una extraordinaria resistencia contra impactos, obteniendo un índice de protección IK10.

La envolvente se adapta perfectamente a condiciones adversas de polvo y humedad gracias a su excelente estanqueidad, obteniendo un grado de protección IP68, pudiendo ser sumergida a 2 metros de profundidad.

Disponibles versiones altas temperaturas.

Características generales

- Cuerpo luminaria: Policarbonato anti-UV 3,5 mm de espesor.
- Tapas: Zamak níquelado.
- Reflector: Aluminio brillante.
- Temperatura de trabajo: De -20° C a +55° C.
- Ensayo filamento incandescente: 960° C.
- Accesorios: 2 bridas de policarbonato antivandálicas y racor metálico PG-11 (incluidas).

EN

Its 3,5mm. polycarbonate body gives it extraordinary protection against impacts, giving it an IK10 protection rating.

The casing is perfectly suited to dusty or wet conditions. Thanks to its excellent protection rating IP68, allows it to be submerged up to 2 meters.

Available in high temperature version.

General characteristics

- Light fitting body: Anti-UV polycarbonate 3,5 mm thickness.
- End caps: Nickel-plated Zamak.
- Reflector: Glossy aluminium.
- Working temperature: From -20° C to +55° C.
- Glow wire test: 960° C.
- Accessories: 2 antivandalism polycarbonate clamps and PG-11 nickel-plated. Cable gland (included).

FR

Son corps en polycarbonate de 3,5 mm d'épaisseur lui confère une extraordinaire résistance aux chocs, obtenant ainsi un degré de protection IK10.

L'enveloppe s'adapte parfaitement aux conditions difficiles de poussière et d'humidité grâce à son excellente étanchéité, obtenant un degré de protection IP68 et pouvant être immergée à 2 mètres de profondeur.

Disponible en version compensé.

Caractéristiques générales

- Corps du luminaire: Polycarbonate anti-UV 3,5 mm d'épaisseur.
- Embouts: Zamak nickelé.
- Réflecteur: Aluminium brillant.
- Température d'utilisation: De -20° C à +55° C.
- Essai du fil incandescent: 960° C.
- Accessoires: 2 colliers de fixation antivandalique en polycarbonate et presse-étoupe métallique PG-11 (inclus).



Ficha técnica
Technical data
Fiche technique

* Recomendamos la utilización de la válvula de condensación para potencias superiores a 2x49W
We recommend the use of ant-condensation valves for voltages higher than 2x49W
Nous recommandons l'utilisation de valves pour des puissances supérieures à 2x49W

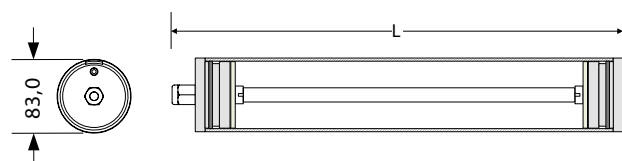

Las luminarias de policarbonato no soportan hidrocarburos

Polycarbonate light fittings don't allow hydrocarbons

Les luminaires de polycarbonate ne supportent pas les hydrocarbures

1 TUBO FLUORESCENTE / 1 LAMP / 1 LAMPE

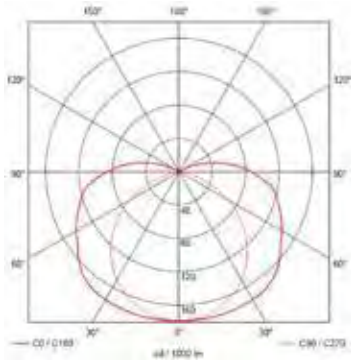

- Electrónica / Electronic / Électronique
- Regulable / Dimmable / Gradable

Ref.	Potencia Watts Puissance	Equipo Equipment Ballast	Largo Length Longueur	Raee EU Recyclable tax Ecotaxe	Precio Price Prix
Q0601	18 W	●	709	0,50 €	196,15 €
Q0607	18 W	●	709	0,50 €	236,15 €
Q0602	36 W	●	1.319	0,50 €	259,42 €
Q0608	36 W	●	1.319	0,50 €	299,42 €
Q0603	58 W	●	1.624	0,50 €	288,19 €
Q0609	58 W	●	1.624	0,50 €	328,19 €

2 TUBOS FLUORESCENTES / 2 LAMPS / 2 LAMPES

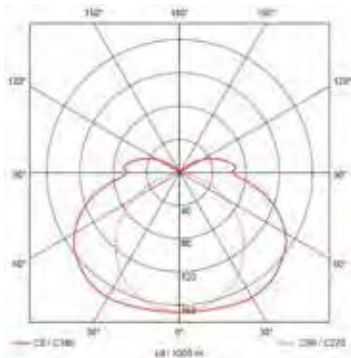

- Electrónica / Electronic / Électronique
- Regulable / Dimmable / Gradable

Ref.	Potencia Watts Puissance	Equipo Equipment Ballast	Largo Length Longueur	Raee EU Recyclable tax Ecotaxe	Precio Price Prix
Q0604	18 W	●	709	0,50 €	205,73 €
Q0610	18 W	●	709	0,50 €	245,73 €
Q0605	36 W	●	1.319	0,50 €	268,06 €
Q0611	36 W	●	1.319	0,50 €	308,06 €
Q0606	58 W	●	1.624	0,50 €	298,31 €
Q0612	58 W	●	1.624	0,50 €	338,31 €



2.1

Luminarias estancas Waterproof luminaires Luminaires étanches

ANTIVANDÁLICA / ANTIVANDALISM / ANTIVANDALISME

1 TUBO FLUORESCENTE / 1 LAMP / 1 LAMPE

G5
T5

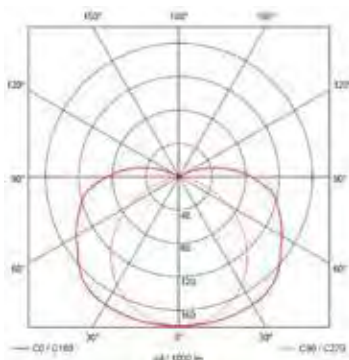

Ref.	Potencia Watts Puissance	Equipo Equipment Ballast	Largo Length Longueur	Raee EU Recyclable tax Ecotaxe	Precio Price Prix
Alta Eficacia / High Efficiency / Haute Efficacité					
Q0613	14 W	●	671	0,50 €	203,18 €
Q0622	14 W	●	671	0,50 €	243,18 €
Q0614	21 W	●	966	0,50 €	234,99 €
Q0623	21 W	●	966	0,50 €	274,99 €
Q0615	28 W	●	1.272	0,50 €	267,62 €
Q0624	28 W	●	1.272	0,50 €	307,62 €
Q0616	35 W	●	1.574	0,50 €	298,64 €
Q0625	35 W	●	1.574	0,50 €	338,64 €
Alto Rendimiento / High Output / Flux Élevé					
Q0617	24 W	●	671	0,50 €	203,18 €
Q0626	24 W	●	671	0,50 €	243,18 €
Q0618	39 W	●	966	0,50 €	234,99 €
Q0627	39 W	●	966	0,50 €	274,99 €
Q0619	49 W	●	1.574	0,50 €	298,64 €
Q0628	49 W	●	1.574	0,50 €	338,64 €
Q0620	54 W	●	1.272	0,50 €	267,62 €
Q0629	54 W	●	1.272	0,50 €	307,62 €
Q0621	80 W	●	1.574	0,50 €	299,09 €
Q0630	80 W	●	1.574	0,50 €	339,09 €

● Electrónica / Electronic / Électronique
● Regulable / Dimmable / Gradable

2 TUBOS FLUORESCENTES / 2 LAMPS / 2 LAMPES

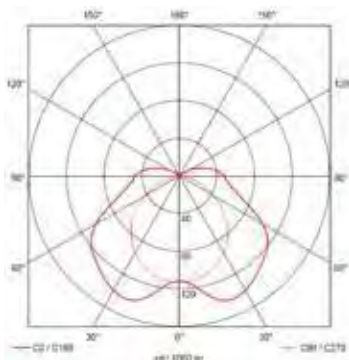

Ref.	Potencia Watts Puissance	Equipo Equipment Ballast	Largo Length Longueur	Raee EU Recyclable tax Ecotaxe	Precio Price Prix
Alta Eficacia / High Efficiency / Haute Efficacité					
Q0631	14 W	●	671	0,50 €	211,59 €
Q0646	14 W	●	671	0,50 €	251,59 €
Q0632	21 W	●	966	0,50 €	243,40 €
Q0647	21 W	●	966	0,50 €	283,40 €
Q0633	28 W	●	1.272	0,50 €	277,52 €
Q0648	28 W	●	1.272	0,50 €	317,52 €
Q0634	35 W	●	1.574	0,50 €	304,19 €
Q0649	35 W	●	1.574	0,50 €	344,19 €
Alto Rendimiento / High Output / Flux Élevé					
Q0635	24 W	●	671	0,50 €	211,59 €
Q0650	24 W	●	671	0,50 €	251,59 €
Q0636	39 W	●	966	0,50 €	243,40 €
Q0651	39 W	●	966	0,50 €	283,40 €
Q0637	49 W	●	1.574	0,50 €	304,19 €
Q0652	49 W	●	1.574	0,50 €	344,19 €
Q0638	54 W	●	1.272	0,50 €	277,82 €
Q0653	54 W	●	1.272	0,50 €	317,82 €

● Electrónica / Electronic / Électronique
● Regulable / Dimmable / Gradable

ANTIVANDÁLICA ALTAS TEMPERATURAS

ANTIVANDALISM HIGH TEMPERATURES

ANTIVANDALISME COMPENSÉ



ES

Características generales

- Cuerpo luminaria: Policarbonato anti-UV 3,5 mm de espesor.
- Tapas: zamak niquelado.
- Reflector: Aluminio brillante.
- Temperatura de trabajo: De -15° C a +85° C.
- Ensayo filamento incandescente: 960° C.
- Accesorios: 2 bridas de policarbonato antivandálicas y racor metálico. PG-11 (incluidas).

EN

General characteristics

- Light fitting body: Anti-UV polycarbonate 3,5 mm thickness.
- End caps: nickel-plated.
- Reflector: Glossy aluminium.
- Working temperature: From -15° C to +85° C.
- Glow wire test: 960° C.
- Accessories: 2 antivandalism polycarbonate clamps and PG-11 nickelplated. Cable gland (included).

FR

Caractéristiques générales

- Corps du luminaire: Polycarbonate anti-UV 3,5 mm. d'épaisseur.
- Embouts: zamak nickelé.
- Réflecteur: Aluminium brillant.
- Température d'utilisation: De -15° C à +85° C.
- Essai du fil incandescent: 960° C.
- Accessoires: 2 colliers antivandalismes de fixation en polycarbonate et presse-étoupe métallique PG-11 (inclus).

G 13
T8

Ref.	Potencia Watts Puissance	Equipo Equipment Ballast	Largo Length Longueur	Raee EU Recyclable tax Ecotaxe	Precio Price Prix
Q0640	1 x 18 W	●	709	0,50 €	203,54 €
Q0641	1 x 36 W	●	1.319	0,50 €	276,51 €
Q0642	1 x 58 W	●	1.624	0,50 €	328,24 €
Q0643	2 x 18 W	●	709	0,50 €	207,49 €
Q0644	2 x 36 W	●	1.319	0,50 €	307,68 €
Q0645	2 x 58 W	●	1.624	0,50 €	384,25 €

● Alto factor / High factor / Hautes températures

2.1

Luminarias estancas

Waterproof luminaires

Luminaires étanches



Brida
Clamp
Collier

ES

Características generales

- Cuerpo luminaria: Policarbonato anti-UV 3,5 mm de espesor.
- Tapas: Zamak niquelado.
- Reflector: Aluminio brillante.
- Temperatura de trabajo: Consultar al fabricante del tubo LED.
- Ensayo filamento incandescente: 960° C.
- Accesorios: 2 bridas de policarbonato antivandálicas y racor metálico PG-11 (incluidas).

EN

General characteristics

- Light fitting body: Anti-UV polycarbonate 3,5 mm thickness.
- End caps: Nickel-plated Zamak.
- Reflector: Glossy aluminium.
- Working temperature: Ask the LED tube manufacturer.
- Glow wire test: 960° C.
- Accessories: 2 antivandalism polycarbonate clamps and PG-11 nickel-plated cable gland (included).

FR

Caractéristiques générales

- Corps du luminaire: Polycarbonate anti-UV 3,5 mm. dé épaisseur.
- Embouts: Zamak nickelé.
- Réflecteur: Aluminium brillant.
- Température d'utilisation: Consultez au fabricant du tube LED
- Essai du fil incandescent: 960° C.
- Accessoires: 2 colliers antivandaliques de fixation en polycarbonate et presse-étoupe métallique PG-11 (inclus)

1 TUBO LED / 1 LED TUBE / 1 TUBE LED

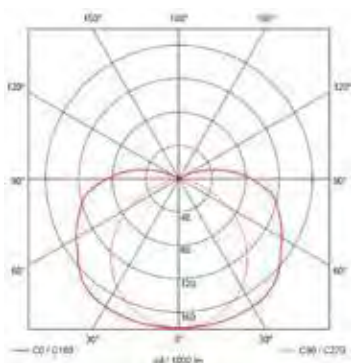
G 13
T8

Ref.	Longitud Tubo Tube Length Longueur Tube	Longitud Luminaria Fitting Length Longueur Luminaire	Raee EU Recyclable tax Ecotaxe	Precio Price Prix
Q0601L	600 mms.	709 mms.	0,50 €	184,15 €
Q0607L	900 mms.	1.089 mms.	0,50 €	215,79 €
Q0602L	1.200 mms.	1.319 mms.	0,50 €	247,42 €
Q0603L	1.500 mms.	1.624 mms.	0,50 €	276,19 €

2 TUBOS LED / 2 LED TUBES / 2 TUBES LED

Ref.	Longitud Tubo Tube Length Longueur Tube	Longitud Luminaria Fitting Length Longueur Luminaire	Raee EU Recyclable tax Ecotaxe	Precio Price Prix
Q0604L	600 mms.	709 mms.	0,50 €	193,73 €
Q0608L	900 mms.	1.089 mms.	0,50 €	224,90 €
Q0605L	1.200 mms.	1.319 mms.	0,50 €	256,06 €
Q0606L	1.500 mms.	1.624 mms.	0,50 €	286,31 €



Ficha técnica
Technical data
Fiche technique

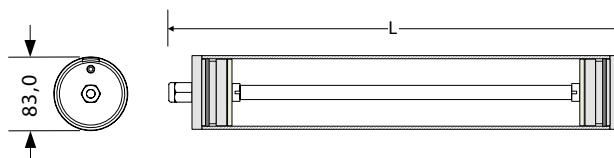



OPAL / MATTE / OPALE



Brida
Clamp
Collier

Potencia Watts <i>Puissance</i>	Aumento precio Price increase <i>Plus value</i>
18 W	2,73 €
36 W	5,23 €
58 W	6,41 €
14-24 W	2,58 €
21-39 W	3,83 €
28-54 W	5,00 €
35-49-80 W	6,25 €

Ref luminaria + "O". Ej.: Q0601O

Light fitting ref + "O". Ex.: Q0601O

Ref luminaire + "O". Ex.: Q0601O



2.1

Luminarias estancas Waterproof luminaires Luminaires étanches

ACCESORIOS RESIST / RESIST ACCESSORIES / ACCESSOIRES RESIST

REF. Q0156

7,40 €



Bridas de acero inoxidable de apertura rápida

(incremento de precio 2 uds.)

Quick opening stainless steel clamps (price increase 2 units.)

Colliers inox de ouverture rapide à grenouillère (plus value de prix 2 uts.)

REF. Q0655

29,99 €



Bridas de acero inoxidable (incremento de precio 2 uds.)

Stainless steel clamps (price increase 2 units.)

Colliers inox antivandalisme (plus value de prix 2 uts.)

REF. Q0159

12,00 €



Bridas de acero cincado (incremento de precio 2 uds.)

Zinc-plated steel clamps (price increase 2 units.)

Colliers en acier galvanisé (plus value de prix 2 uts.)

REF. Q0153

9,30 €



Brida de policarbonato antivandálica (2 unidades)

Antivandalic polycarbonate clamp (2 units)

Colliers en polycarbonate antivandalisme (2 uts.)

REF. Q0160

17,22 €



Válvula anticondensación y de equilibrado de presión

Anticondensation valve and pressure balancing

Valve anti-condensation et équilibrage de pression

REF. Q0349

12,21 €



Suspensión con cable de acero

Steel cable suspension

Suspension avec câble en acier

REF. Q0403

43,86 €



Opción conexión rápida IP68

Incluye tubos fluorescentes

Quick IP68 connection option

Fluorescent lamps included

Option connectique rapide

WIELAND IP68

Lampes inclus

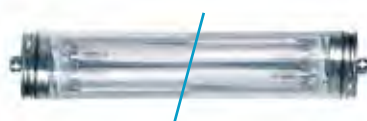

Opción línea continua

Continuous line option

Câblage traversant

3 polos / 3 poles / 3 pôles

REF. Q0565

23,09 €

5 polos / 5 poles / 5 pôles

REF. Q0566

35,35 €

Reflectores especiales en página 95

Special reflectors in page 95

Réflecteurs spéciaux en page 95



RESIST

Fábrica Schwartz-Hautmont , Tarragona, España
[Schwartz-Hautmont factory, Tarragona, Spain](#)
Usine Schwartz-Hautmont, Tarragone, Espagne



RESIST

Túnel peatonal, AVE, Zaragoza, España
[Pedestrian tunnel AVE, Zaragoza, Spain](#)
Tunnel pour piétonnier AVE, Saragosse, Espagne



2.1

Luminarias estancas Waterproof luminaires Luminaires étanches



Brida
Clamp
Collier

ES

Esta luminaria ha sido concebida especialmente para su uso en túneles. Construida en materiales autoextinguibles y diseñada para absorber las vibraciones de los vehículos que puedan transitar por éstas galerías sin afectar a su funcionamiento.

Aporta seguridad en las instalaciones donde la calidad y resistencia de las luminarias ante cualquier incidente es primordial.

Para minimizar y facilitar las labores de mantenimiento, sus componentes son de larga duración, llegando a ser 3 veces superior a una luminaria convencional.

Para asegurar su larga vida, esta luminaria se suministra con los tubos fluorescentes incluidos.

4 años de garantía válida para funcionamiento con ciclo de conmutación de 12 horas (11 horas on, 1 hora off).

Características generales

- Cuerpo luminaria: Policarbonato M1 anti-UV 2 mm de espesor.
- Tapas: ABS V0 autoextinguible.
- Reflector: Aluminio brillante.
- Temperatura de trabajo: De -20° C a +55° C.
- Ensayo filamento incandescente: 850° C.
- Accesorios: 2 bridas de sujeción de acero cincado y racor metálico PG-11 (incluidos).

EN

This light fitting has been specifically designed for use in tunnels. It is constructed mainly of self-extinguishing materials and designed to absorb the vibrations generated by the vehicles that pass through these tunnels without affecting how it works. It provides safety in installations where the quality and resistance of the light fittings are essential in the event of any incident. In order to minimise and facilitate maintenance tasks, its components are hard-wearing, lasting as much as three times longer than a conventional light fitting. To ensure its long life, this light fitting is supplied with fluorescent tubes.

4 years of warranty valid for operation with switching cycle of 12 hours (11 hours on, 1 hour off).

General characteristics

- Light fitting body: M1 Anti-UV polycarbonate 2 mm thickness.
- End caps: ABS V0 self-extinguishing.
- Reflector: Glossy aluminium.
- Working temperature: From -20° C to +55° C.
- Glow wire test: 850° C.
- Accessories: 2 zinc-plated steel clamps and PG-11 nickel-plated cable gland (included).

FR

Luminaire spécialement conçu pour son utilisation dans les tunnels.

Fabriqué avec des matériaux auto-extinguibles. Absorbe les vibrations des véhicules circulant dans le tunnel. Sécurité renforcée dans les installations où la qualité et la résistance des luminaires sont primordiales en cas d'incident. La durée de vie de ses composantes, 3 fois supérieure à celle d'un luminaire conventionnel permet d'optimiser l'entretien. L'utilisation des tubes fluorescents fournis allonge la vie du luminaire.

4 ans de garantie applicable avec fonctionnement du luminaire avec le suivant cycle de conmutation: 12 heures (11 heures on, 1 heure off).

Caractéristiques générales

- Corps du luminaire: Polycarbonate M1 anti-UV 2 mm d'épaisseur.
- Embouts: ABS V0 auto-extinguible.
- Réflecteur: Aluminium brillant.
- Température d'utilisation: De -20 C a +55° C.
- Essai du fil incandescent: 850° C.
- Accessoires: 2 colliers de fixation en acier galvanisé et presse-étoupe métallique PG-11 (inclus).



Ficha técnica
Technical data
Fiche technique

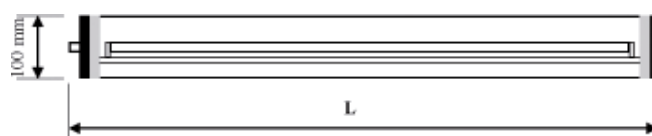

Las luminarias de policarbonato no soportan hidrocarburos

Polycarbonate light fittings don't allow hydrocarbons

Les luminaires de polycarbonate ne supportent pas les hydrocarbures

1 TUBO FLUORESCENTE / 1 LAMP / 1 LAMPE

G5
T5

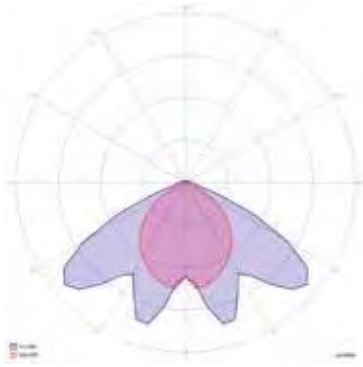

● Electrónica / Electronic / Électronique

Ref.	Potencia Watts Puissance	Equipo Equipment Ballast	Largo Length Longueur	Raee EU Recyclable tax Ecotaxe	Precio Price Prix
Alta Eficacia / High Efficiency / Haute Efficacité					
Q0801	14 W	●	675	0,50 €	364,77 €
Q0802	21 W	●	970	0,50 €	405,41 €
Q0803	28 W	●	1.276	0,50 €	442,82 €
Q0804	35 W	●	1.578	0,50 €	477,10 €
Alto Rendimiento / High Output / Flux Élevé					
Q0805	24 W	●	675	0,50 €	376,88 €
Q0806	39 W	●	970	0,50 €	417,84 €
Q0807	49 W	●	1.578	0,50 €	485,93 €
Q0808	54 W	●	1.276	0,50 €	461,57 €
Q0809	80 W	●	1.578	0,50 €	501,32 €

2 TUBOS FLUORESCENTES / 2 LAMPS / 2 LAMPES

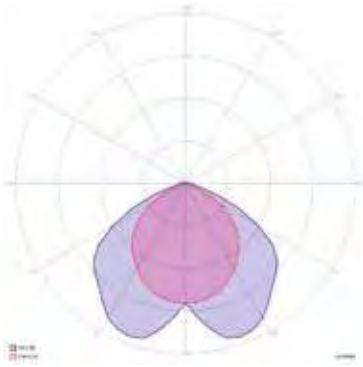

● Electrónica / Electronic / Électronique

Ref.	Potencia Watts Puissance	Equipo Equipment Ballast	Largo Length Longueur	Raee EU Recyclable tax Ecotaxe	Precio Price Prix
Alta Eficacia / High Efficiency / Haute Efficacité					
Q0819	14 W	●	675	0,50 €	498,51 €
Q0820	21 W	●	970	0,50 €	547,38 €
Q0821	28 W	●	1.276	0,50 €	585,66 €
Q0822	35 W	●	1.578	0,50 €	625,65 €
Alto Rendimiento / High Output / Flux Élevé					
Q0823	24 W	●	675	0,50 €	518,67 €
Q0824	39 W	●	970	0,50 €	571,83 €
Q0825	49 W	●	1.578	0,50 €	657,44 €
Q0826	54 W	●	1.276	0,50 €	617,22 €

2.1

Luminarias estancas

Waterproof luminaires

Luminaires étanches



ES

Esta luminaria ha sido concebida especialmente para su uso en túneles. Construida en materiales autoextinguibles y diseñada para absorber las vibraciones de los vehículos que puedan transitar por éstas galerías sin afectar a su funcionamiento. Aporta seguridad en las instalaciones donde la calidad y resistencia de las luminarias ante cualquier incidente es primordial.

Características generales

- Cuerpo luminaria: Policarbonato M1 anti-UV 2 mm de espesor.
- Tapas: ABS V0 autoextinguible.
- Reflector: Aluminio brillante.
- Temperatura de trabajo: Consultar al fabricante del tubo LED
- Ensayo filamento incandescente: 850° C.
- Accesorios: 2 bridas de sujeción de acero cincado y racor metálico (incluidos).

EN

This light fitting has been specifically designed for use in tunnels. It is constructed mainly of self-extinguishing materials and designed to absorb the vibrations generated by the vehicles that pass through these tunnels without affecting how it works. It provides safety in installations where the quality and resistance of the light fittings are essential in the event of any incident.

General characteristics

- Light fitting body: M1 Anti-UV polycarbonate 2 mm thickness.
- End caps: ABS V0 self-extinguishing.
- Reflector: Glossy aluminium.
- Working temperature: Ask the LED tube manufacturer
- Glow wire test: 850° C.
- Accessories: 2 zinc-plated steel clamps and PG-11 nickel-plated cable gland (included).

FR

Luminaire spécialement conçu pour son utilisation dans les tunnels. Fabriqué avec des matériaux auto-extinguibles. Absorbe les vibrations des véhicules circulant dans le tunnel. Sécurité renforcée dans les installations où la qualité et la résistance des luminaires sont primordiales en cas d'incident.

Caractéristiques générales

- Corps du luminaire: Polycarbonate M1 anti-UV 2 mm d'épaisseur.
- Embouts: ABS V0 auto-extinguible.
- Réflecteur: Aluminium brillant.
- Température d'utilisation: Consultez au fabricant du tube LED
- Essai du fil incandescent: 850° C.
- Accessoires: 2 colliers de fixation en acier galvanisé et presse-étoupe métallique PG-11 (inclus).



Ficha técnica
Technical data
Fiche technique

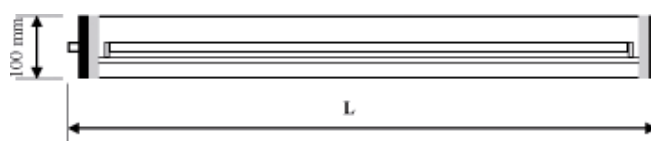

Las luminarias de policarbonato no soportan hidrocarburos

Polycarbonate light fittings don't allow hydrocarbons

Les luminaires de polycarbonate ne supportent pas les hydrocarbures

1 TUBO LED / 1 LED TUBE / 1 TUBE LED

Ref.	Longitud Tubo Tube Length Longueur Tube	Longitud Luminaria Fitting Length Longueur Luminaire	Raee EU Recyclable tax Ecotaxe	Precio Price Prix
Q0801L	600 mms.	675 mms.	0,50 €	202,46 €
Q0802L	900 mms.	1.055 mms.	0,50 €	235,09 €
Q0803L	1.200 mms.	1.285 mms.	0,50 €	270,36 €
Q0804L	1.500 mms.	1.589 mms.	0,50 €	300,81 €

2 TUBOS LED / 2 LED TUBES / 2 TUBES LED

Ref.	Longitud Tubo Tube Length Longueur Tube	Longitud Luminaria Fitting Length Longueur Luminaire	Raee EU Recyclable tax Ecotaxe	Precio Price Prix
Q0805L	600 mms.	675 mms.	0,50 €	204,09 €
Q0806L	900 mms.	1.055 mms.	0,50 €	236,41 €
Q0807L	1.200 mms.	1.285 mms.	0,50 €	271,98 €
Q0808L	1.500 mms.	1.589 mms.	0,50 €	302,44 €



TUNNEL

Tunel de paso Jardinillos, Palencia, España. Luminaria Tunnel

[Paso Jardinillos Tunnel, Palencia, Spain. Tunnel lumineaire](#)

Paso Jardinillos Tunnel, Palencia, Espagne. Luminaire Tunnel



TUNNEL

Tunel de paso Jardinillos, Palencia, España. Luminaria Tunnel
Paso Jardinillos Tunnel, Palencia, Spain. Tunnel luminaire
Paso Jardinillos Tunnel, Palencia, Espagne. Luminaire Tunnel

2.1

Luminarias estancas

Waterproof luminaires

Luminaires étanches



Bridas
Clamps
Colliers

ES

Esta luminaria está indicada en hornos, campanas industriales o cualquier lugar donde no sea posible la utilización de lámparas fluorescentes, hasta 200°C.

- Hornos.
- Campanas industriales.
- Pasillos de altos hornos.
- Fundiciones.
- Máquinas con zonas de alta temperatura donde sea necesaria luz.

Características generales

- Cuerpo: vidrio borosilicato 5mm espesor.
- Estructura interna: chasis en acero galvanizado.
- Tapas finales: acero inoxidable 316. Cierre mediante tornillo con junta de vitón. Tornillo estanco inoxidable. Junta de cierre en silicona.
- Alimentación: 220-240V, 50-60Hz. 0,06-0,7 A
- Lámparas: 2 halógenas G9 para hornos hasta 40W
- Temperatura de trabajo: -50°C - +200 °c.
- Accesorios incluidos: 2 Bridas en acero inoxidable rápidas.
- Prensaestopas: Metálicos

EN

This luminaire is suitable for ovens, industrial hoods or any location up to 200 °C where fluorescent lamps cannot be used.

- Ovens.
- Industrial hoods.
- Blast furnace passages and flues.
- Foundries.
- Machines with high temperature areas that require light.

General characteristics

- Body: 5 mm thick borosilicate glass.
- Internal structure: Galvanized steel frame.
- End caps: Type 316 stainless steel. Screw-in closure with Viton seal. Hermetic rust-proof screw. Silicone sealing gasket.
- Power supply: 220-240V, 50-60Hz 0.06-0.7 A
- Lamps: 2 G9 halogen lamps for ovens up to 40W.
- Working temperature: -50°C - +200 °C.
- Accessories included: 2 Rapid stainless steel clamps.
- Cable glands: Metal.

FR

Ce luminaire est indiqué pour les fours, les hottes industrielles ou tout autre cas où l'utilisation de lampes fluorescentes serait contre-indiquée, jusqu'à 200°C.

- Fours.
- Hottes industrielles.
- Couloirs et passerelles des hauts fourneaux.
- Fonderies.
- Machines avec zones exposées à de fortes températures devant être éclairées.

Caractéristiques générales

- Corps: Verre borosilicate 5 mm d'épaisseur.
- Structure interne: Châssis en acier galvanisé.
- Embouts: Acier inoxydable 316. Fermeture par vis avec joint en Viton. Vis d'étanchéité inoxydable. Joint de fermeture en silicone.
- Alimentation: 220-240V, 50-60Hz. 0,06-0,7 A
- Lampes: 2 halogènes G9 pour fours jusqu'à 40W.
- Température d'utilisation: -50°C - +200 °C
- Accessoires inclus: 2 Colliers en acier inoxydable rapides.
- Presse-étoupe: Métalliques.



Ficha técnica
Technical data
Fiche technique

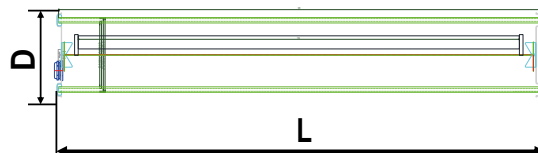

Ref.	Potencia Watts <i>Puissance</i>	Largo Length <i>Longueur</i>	Ancho Wide <i>Large</i>	Raee EU Recyclable tax <i>Ecotaxe</i>	Precio Price <i>Prix</i>
Q0949	1x40 W	275	96	0,50 €	409,68 €
Q0950	2x40 W	275	96	0,50 €	428,36 €

Esta luminaria es compatible con bombillas de las clases energéticas: C, D y E.

This luminaire is compatible with bulbs of energy classes: C, D and E.

Ce luminaire est compatible avec des ampoules des classes énergétiques: C, D et E.



2.1

Luminarias estancas

Waterproof luminaires

Luminaires étanches

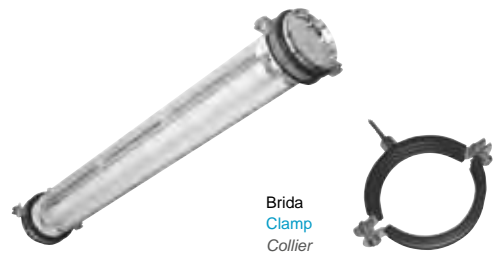

ANTIVANDÁLICA / ANTIVANDALISM / ANTIVANDALISME

ES

Su cuerpo de metacrilato de 5 mm de espesor le da una extraordinaria resistencia contra impactos, obteniendo un índice de protección IK10. La envolvente se adapta perfectamente a condiciones adversas de polvo y humedad gracias a su excelente estanqueidad, obteniendo un grado de protección IP68, pudiendo ser sumergida a 2 metros de profundidad. Esta luminaria une la estanqueidad, la robustez y el diseño. Es la solución perfecta para iluminar espacios donde se requiera una luminaria con una alta calidad y capaz de soportar las peores condiciones y los hidrocarburos, lo que hace que sea ideal para su uso en: campanas de cocina industriales, viveros, fuentes, piscinas, iluminación directa de maquinaria (resistente a golpes), iluminación exterior.

Disponibles versiones altas temperaturas.

Características generales

- Cuerpo luminaria: Metacrilato anti-UV de 5 mm de espesor.
- Tapas: Zamak níquelado.
- Reflector: Aluminio brillante.
- Temperatura de trabajo: De -20° C a +55° C.
- Accesorios: 2 bridas de sujeción de acero cincado y racor metálico PG 11.

EN

Its 5mm. acrylic body gives it extraordinary protection against impacts, giving it an IK10 protection rating. The lasing is perfectly suited to dusty or wet conditions. Thanks to its excellent protection rating IP68, allows it to be submerged up to 2 meters. This light fixture unites waterproofing, strength and design. It's the perfect solution to illuminate spaces that require a high quality fixture, that is able to stand the worst conditions and hydrocarbons, which makes it ideal for its use in: industrial cooking hoods, greenhouses, fountains, pools, direct tool lighting (resists direct hits), outdoor lighting.

Available in high temperature version.

General characteristics

- Light fitting body: Acrylic anti-UV 5 mm. thickness.
- End caps: Nickel-plated Zamak.
- Reflector: Glossy aluminium.
- Working temperature: From -20° C to +55° C.
- Accessories: 2 zinc-plated steel clamps and PG-11 nickel-plated cable gland.

FR

Son corps de méthacrylate de 5 mm d'épaisseur lui donne une extraordinaire résistance face aux impacts, obtenant un indice de protection d'IK10. L'enveloppe s'adapte parfaitement aux conditions adverses de poussières et humidité grâce à son excellente étanchéité, obtenant un degré de protection IP68, pouvant être submergé à 2 mètres de profondeur. Ce luminaire unit l'étanchéité, la robustesse et le dessin. C'est la solution parfaite pour éclairer les espaces qui ont besoin d'un luminaire avec un éclairage de haute qualité et qui soit capable de supporter les pires conditions, cela fait qu'il soit idéal pour son usage dans : hottes de cuisines, pépinières, fontaines, piscines, cabines de peinture, éclairage direct de machinerie (résistante aux chocs), éclairage extérieur.

Disponible le modèle pour compensé.

Caractéristiques générales

- Corps du luminaire: Méthacrylate anti-UV de 5 mm d'épaisseur.
- Embouts: Zamak nickelé.
- Réflecteur: Aluminium brillant.
- Température d'utilisation: De -20° C à +55° C.
- Accessoires: 2 colliers de fixation en acier galvanisé et presse-étoupe métallique PG-11.



Ficha técnica
Technical data
Fiche technique

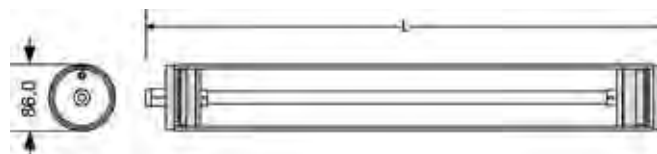

1 TUBO FLUORESCENTE / 1 LAMP / 1 LAMPE

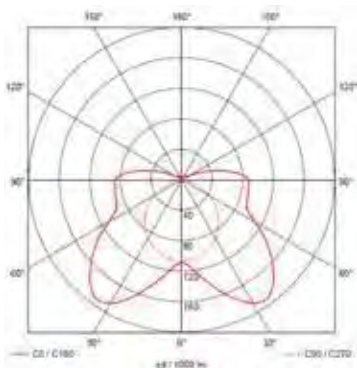

- Electrónica / Electronic / Électronique
- Regulable / Dimmable / Gradable

Ref.	Potencia Watts Puissance	Equipo Equipment Ballast	Largo Length Longueur	Raee EU Recyclable tax Ecotaxe	Precio Price Prix
Q0435	18 W	●	709	0,50 €	222,28 €
Q0463	18 W	●	709	0,50 €	262,28 €
Q0436	36 W	●	1.319	0,50 €	331,59 €
Q0464	36 W	●	1.319	0,50 €	371,59 €
Q0437	58 W	●	1.624	0,50 €	386,29 €
Q0465	58 W	●	1.624	0,50 €	426,29 €

2 TUBOS FLUORESCENTES / 2 LAMPS / 2 LAMPES

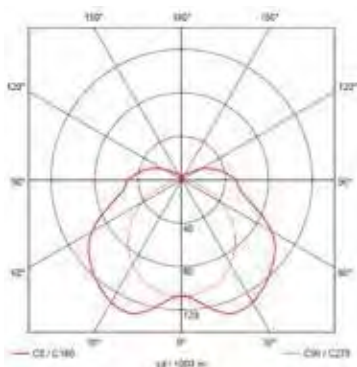

- Electrónica / Electronic / Électronique
- Regulable / Dimmable / Gradable

Ref.	Potencia Watts Puissance	Equipo Equipment Ballast	Largo Length Longueur	Raee EU Recyclable tax Ecotaxe	Precio Price Prix
Q0438	18 W	●	709	0,50 €	230,99 €
Q0466	18 W	●	709	0,50 €	270,99 €
Q0439	36 W	●	1.319	0,50 €	341,46 €
Q0467	36 W	●	1.319	0,50 €	381,46 €
Q0440	58 W	●	1.624	0,50 €	395,55 €
Q0468	58 W	●	1.624	0,50 €	435,55 €



2.1

Luminarias estancas Waterproof luminaires Luminaires étanches

ANTIVANDÁLICA / ANTIVANDALISM / ANTIVANDALISME

1 TUBO FLUORESCENTE / 1 LAMP / 1 LAMPE

G5
T5

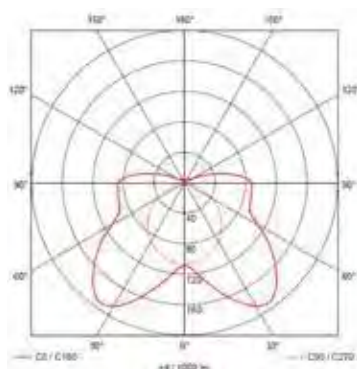

Ref.	Potencia Watts Puissance	Equipo Equipment Ballast	Largo Length Longueur	Raee EU Recyclable tax Ecotaxe	Precio Price Prix
Alta Eficacia / High Efficiency / Haute Efficacité					
Q0451	14 W	●	671	0,50 €	223,69 €
Q0469	14 W	●	671	0,50 €	263,69 €
Q0452	21 W	●	966	0,50 €	278,14 €
Q0470	21 W	●	966	0,50 €	318,14 €
Q0453	28 W	●	1.272	0,50 €	330,26 €
Q0477	28 W	●	1.272	0,50 €	370,26 €
Q0454	35 W	●	1.574	0,50 €	384,11 €
Q0478	35 W	●	1.574	0,50 €	424,11 €
Alto Rendimiento / High Output / Flux Élevé					
Q0487	24 W	●	671	0,50 €	223,69 €
Q0493	24 W	●	671	0,50 €	263,69 €
Q0455	39 W	●	966	0,50 €	278,14 €
Q0479	39 W	●	966	0,50 €	318,14 €
Q0488	49 W	●	1.574	0,50 €	384,46 €
Q0494	49 W	●	1.574	0,50 €	424,46 €
Q0456	54 W	●	1.272	0,50 €	330,26 €
Q0480	54 W	●	1.272	0,50 €	370,26 €
Q0489	80 W	●	1.574	0,50 €	391,11 €
Q0495	80 W	●	1.574	0,50 €	431,11 €

● Electrónica / Electronic / Électronique
● Regulable / Dimmable / Gradable

2 TUBOS FLUORESCENTES / 2 LAMPS / 2 LAMPES

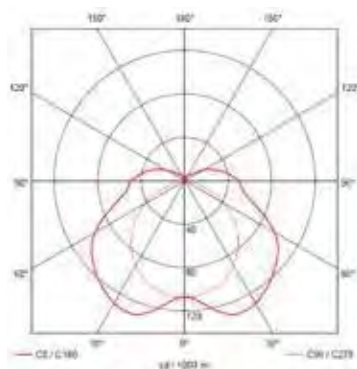

Ref.	Potencia Watts Puissance	Equipo Equipment Ballast	Largo Length Longueur	Raee EU Recyclable tax Ecotaxe	Precio Price Prix
Alta Eficacia / High Efficiency / Haute Efficacité					
Q0457	14 W	●	671	0,50 €	231,85 €
Q0481	14 W	●	671	0,50 €	271,85 €
Q0458	21 W	●	966	0,50 €	285,58 €
Q0482	21 W	●	966	0,50 €	325,58 €
Q0459	28 W	●	1.272	0,50 €	339,12 €
Q0483	28 W	●	1.272	0,50 €	379,12 €
Q0460	35 W	●	1.574	0,50 €	382,23 €
Q0484	35 W	●	1.574	0,50 €	422,23 €
Alto Rendimiento / High Output / Flux Élevé					
Q0490	24 W	●	671	0,50 €	235,85 €
Q0496	24 W	●	671	0,50 €	275,85 €
Q0461	39 W	●	966	0,50 €	285,58 €
Q0485	39 W	●	966	0,50 €	325,58 €
Q0491	49 W	●	1.574	0,50 €	382,23 €
Q0497	49 W	●	1.574	0,50 €	422,23 €
Q0462	54 W	●	1.272	0,50 €	339,12 €
Q0486	54 W	●	1.272	0,50 €	379,12 €

● Electrónica / Electronic / Électronique
● Regulable / Dimmable / Gradable

ANTIVANDÁLICA ALTAS TEMPERATURAS

ANTIVANDALISM HIGH TEMPERATURES

ANTIVANDALISME COMPENSÉ



ES

Características generales

- Cuerpo luminaria: Metacrilato de 5 mm de espesor.
- Tapas: Zamak niquelado.
- Reflector: Chapa de acero de alta resistencia blanca.
- Temperatura de trabajo: De -15° C a +80° C.
- Accesorios: 2 bridas de sujeción de acero cincado y racor metálico PG-11 (incluidas).

En versión para 2 tubos de 36 y 58 W, el equipo electrónico especial para condiciones ambientales duras, irá separado en un segundo cuerpo tubular de 671 mms. Ambos cuerpos estarán unidos por un cable de un metro cubierto por una funda de protección térmica.

Aplicaciones específicas:

- Campanas industriales de cocina.

EN

General characteristics

- Light fitting body: Acrylic 5 mm. thickness.
- End caps: Nickel-plated Zamak.
- Reflector: High resistant white lacquered steel.
- Working temperature: From -15° C to +80° C.
- Accessories: 2 zinc-plated steel clamps and PG-11 nickel-plated cable gland (included).

In the version for 2 tubes of 36 and 58 W, the electronic special equipment for harsh environmental conditions, will be separated in a second tubular body of 671 mms. Both bodies will be joined by a cable covered by a thermal protection sleeve of 1 m.

Specific applications:

- Kitchen hood.

FR

Caractéristiques générales

- Corps du luminaire: Méthacrylate de 5 mm de épaisseur.
- Embouts: Zamak nickelé.
- Réflecteur: Aluminium brillant.
- Température d'utilisation: De -15° C à +80° C.
- Accessoires: 2 colliers de fixation en acier galvanisé et presse-étoupe métallique PG-11 (inclus).

Sur les versions pour les puissances 2x36 et 2x58, les ballasts spéciaux pour conditions extrêmes sont séparés dans un deuxième corps tubulaire de 671mms. Les deux corps sont reliés par un câble d'un mètre protégé par un fourreau de protection thermique.

Applications spécifiques:

- Hottes de cuisines.

G 13
T8

Ref.	Potencia Watts Puissance	Equipo Equipment Ballast	Largo Length Longueur	Raee EU Recyclable tax Ecotaxe	Precio Price Prix
Q0471	1 x 18 W	●	709	0,50 €	224,43 €
Q0472	1 x 36 W	●	1.319	0,50 €	318,99 €
Q0473	1 x 58 W	●	1.624	0,50 €	388,00 €
Q0474	2 x 18 W	●	709	0,50 €	237,21 €
Q0475	2 X 36 W	●	1.319	0,50 €	564,04 €
Q0476	2 X 58 W	●	1.624	0,50 €	605,35 €

● Alto factor / High factor / Hautes températures

● Electrónica / Electronic / Electronique



1 X 18 W - 1 X 36 W - 1 X 58 W - 2 X 18 W



2 X 36 W - 2 X 58 W

2.1

Luminarias estancas
Waterproof luminaires
Luminaires étanches

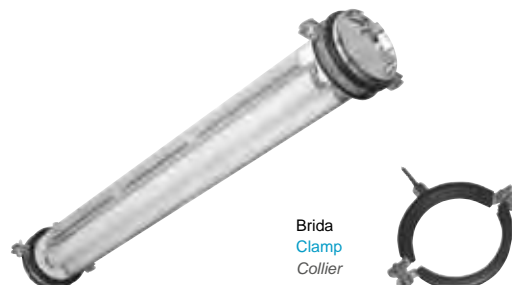

Brida
Clamp
Collier

ANTIVANDÁLICA / ANTIVANDALISM / ANTIVANDALISME

ES

Su cuerpo de metacrilato de 5 mm de espesor le da una extraordinaria resistencia contra impactos, obteniendo un índice de protección IK10.

Características generales

- Cuerpo luminaria: Metacrilato anti-UV de 5 mm de espesor.
- Tapas: Zamak níquelado.
- Reflector: Aluminio brillante.
- Temperatura de trabajo: Consultar al fabricante del tubo LED
- Accesorios: 2 bridas de sujeción de acero cincado y racor metálico PG-11.

EN

Its 5mm. acrylic body gives it extraordinary protection against impacts, giving it an IK10 protection rating.

General characteristics

- Light fitting body: Acrylic anti-UV 5 mm. thickness.
- End caps: Nickel-plated Zamak.
- Reflector: Glossy aluminium.
- Working temperature: Ask the LED tube manufacturer
- Accessories: 2 zinc-plated steel clamps and PG-11 nickel-plated cable gland.

FR

Son corps de méthacrylate de 5 mm d'épaisseur lui donne une extraordinaire résistance face aux impacts, obtenant un indice de protection d'IK10.

Caractéristiques générales

- Corps du luminaire: Méthacrylate anti-UV de 5 mm d'épaisseur.
- Embouts: Zamak nickelé.
- Réflecteur: Aluminium brillant.
- Température d'utilisation: Consultez au fabricant du tube LED
- Accessoires: 2 colliers de fixation en acier galvanisé et presse-étoupe métallique PG-11.

1 TUBO LED / 1 LED TUBE / 1 TUBE LED

G 13
T8

Ref.	Longitud Tubo Tube Length Longueur Tube	Longitud Luminaria Fitting Length Longueur Luminaire	Raee EU Recyclable tax Ecotaxe	Precio Price Prix
Q0435L	600 mms.	675 mms.	0,50 €	210,28 €
Q0441L	900 mms.	1.055 mms.	0,50 €	264,90 €
Q0436L	1.200 mms.	1.285 mms.	0,50 €	319,51 €
Q0437L	1.500 mms.	1.589 mms.	0,50 €	374,29 €

2 TUBOS LED / 2 LED TUBES / 2 TUBES LED

Ref.	Longitud Tubo Tube Length Longueur Tube	Longitud Luminaria Fitting Length Longueur Luminaire	Raee EU Recyclable tax Ecotaxe	Precio Price Prix
Q0438L	600 mms.	675 mms.	0,50 €	218,99 €
Q0442L	900 mms.	1.055 mms.	0,50 €	274,23 €
Q0439L	1.200 mms.	1.285 mms.	0,50 €	329,46 €
Q0440L	1.500 mms.	1.589 mms.	0,50 €	383,55 €



Ficha técnica
Technical data
Fiche technique

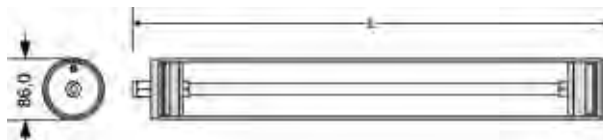



OPAL / MATTE / OPALE



Potencia Watts <i>Puissance</i>	Aumento precio Price increase <i>Plus value</i>
18 W	3,75 €
36 W	7,11 €
58 W	8,83 €
14-24 W	3,52 €
21-39 W	5,16 €
28-54 W	6,88 €
35-49-80 W	8,52 €

Ref luminaria + "O". Ej.: Q04350

Light fitting ref + "O". Ex.: Q04350

Ref luminaire + "O". Ex.: Q04350



2.1

Luminarias estancas Waterproof luminaires Luminaires étanches

ACCESORIOS TR2 / TR2 ACCESSORIES / ACCESSOIRES TR2

REF. Q0401

30,17 €



Bridas de acero inoxidable
(incremento de precio 2 uds.)
Stainless steel clamps
(price increase 2 units.)
Colliers inox antivandalisme
(plus value de prix 2 uts.)

REF. Q0402

7,40 €



**Bridas de acero inoxidable de
apertura rápida**
(incremento de precio 2 uds.)
**Quick opening stainless steel
clamps** (price increase 2 units.)
**Colliers inox de ouverture rapide à
grenouillère** (plus value de prix 2 uts.)

REF. Q0158

1,00 €



Brida de metacrilato antivandálica
(incremento de precio 2 uds.)
Antivandalic acrylic clamps
(price increase 2 units.)
**Colliers antivandalisme en
méthacrylate** (plus value 2 uts.)

REF. Q0349

12,21 €



Suspensión con cable de acero
Steel cable suspension
Suspension avec câble en acier

REF. Q0160

17,22 €



**Válvula anticondensación y de
equilibrado de presión**
**Anticondensation valve
and pressure balancing**
**Valve anti-condensation et
équilibre de pression**

REF. Q0403

43,91 €



Opción conexión rápida IP68
Incluye tubos fluorescentes
Quick IP68 connection option
Fluorescent lamps included
Option connectique rapide IP68
Lampes inclus

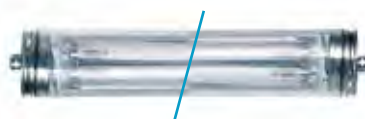

Opción línea continua
Continuous line option
Câblage traversant

3 polos / 3 poles / 3 pôles

REF. Q0404

22,88 €

5 polos / 5 poles / 5 pôles

REF. Q0406

46,02 €

Reflectores especiales en página 119
Special reflectors in page 119
Réflecteurs spéciaux en page 119



TR3

Universidad de Pais Vasco, Bilbao, España
Basque Country University, Bilbao, Spain
Université du Pays Basque, Bilbao, Espagne



2.2

Luminarias estancas

Waterproof luminaires

Luminaires étanches

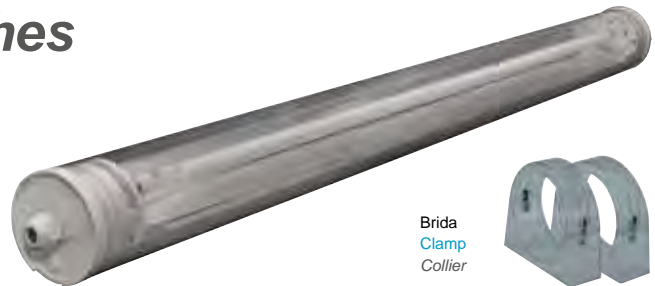

Brida
Clamp
Collier

ES

Luminaria en policarbonato de 1 mm de espesor y terminales en ABS, se incluyen bridas de sujeción facilitando la labor del montaje del instalador. Esta luminaria posee un grado de protección IP67 que ofrece protección total contra el polvo y contra la penetración de agua en cantidad perjudicial en el interior de la envolvente sumergida en agua, que la hace ideal para su uso en cámaras frigoríficas, viveros, fuentes, piscinas y gimnasios, invernaderos, puentes. Disponible versión bajas temperaturas.

Características generales

- Cuerpo luminaria: Policarbonato bicolor de 1 mm de espesor.
- Tapas: A.B.S.
- Reflector: Aluminio brillante.
- Temperatura de trabajo: De -20° C a +55° C.
- Ensayo hilo incandescente: 850° C.
- Accesorios: 2 bridas de policarbonato antivandálicas y prensaestopas de poliamida PG-11.

EN

1 mm thick polycarbonate and A.B.S. terminals, ceiling clamps included, making installation easier. This light fixture has a IP67 protection grade, which offers total protection against dust and water seepage in prejudicial quantities in the interior of the cavity submerged in water, which makes it ideal for its use in refrigeration rooms, greenhouses, pools, health clubs and bridges. Available in low temperature version.

General characteristics

- Light fitting body: Polycarbonate two coloured 1 mm thickness.
- End caps: A.B.S.
- Reflector: Glossy aluminium.
- Working temperature: From -20° C to +55° C.
- Glow wire test: 850° C.
- Accessories: 2 antivandalism polycarbonate clamps and PG-11 polyamide cable gland.

FR

Le modèle TR3 est un luminaire étanche de conception offrant de hautes prestations avec une étanchéité IP67.

Luminare en polycarbonate de 1 mm d'épaisseur et embouts en A.B.S., on inclue des colliers de fixation antivandaliques en polycarbonate.

Ce luminaire possède un degré de protection IP67 qui offre une protection totale face à la poussière et face à l'eau, ce qui le fait idéal pour son utilisation dans des chambres frigorifiques, pépinières, fontaines, piscines, gymnases, serres, ponts. Disponible le modèle pour basses températures.

Caractéristiques générales

- Corps du luminaire: Polycarbonate bicolore de 1 mm d'épaisseur.
- Embouts: A.B.S.
- Réflecteur: Aluminium brillant.
- Colliers: Polycarbonate.
- Température d'utilisation: De -20° C a +55° C.
- Essai du fil incandescent: 850° C.
- Accessoires: 2 colliers en polycarbonate antivandalisme et presse-étoupe PG-11.



Ficha técnica
Technical data
Fiche technique

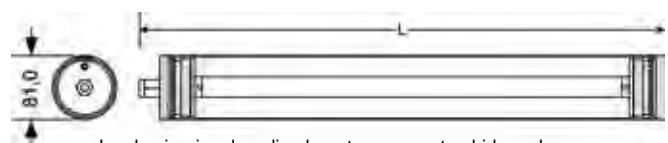

Las luminarias de policarbonato no soportan hidrocarburos

Polycarbonate light fittings don't allow hydrocarbons

Les luminaires de polycarbonate ne supportent pas les hydrocarbures

1 TUBO FLUORESCENTE / 1 LAMP / 1 LAMPE

G 13
T8

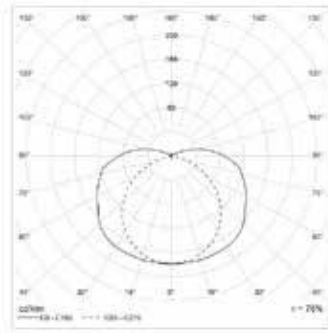

Ref.	Potencia Watts Puissance	Equipo Equipment Ballast	Largo Length Longueur	Raee EU Recyclable tax Ecotaxe	Precio Price Prix
Q0007	15 W	●	563	0,50 €	72,09 €
Q0008	18 W	●	713	0,50 €	72,94 €
Q0035	18 W	●	713	0,50 €	94,67 €
Q0063	18 W	●	713	0,50 €	134,67 €
Q0010	30 W	●	1.018	0,50 €	88,29 €
Q0011	36 W	●	1.323	0,50 €	91,92 €
Q0036	36 W	●	1.323	0,50 €	109,77 €
Q0064	36 W	●	1.323	0,50 €	149,77 €
Q0012	58 W	●	1.628	0,50 €	106,01 €
Q0037	58 W	●	1.628	0,50 €	119,99 €
Q0065	58 W	●	1.628	0,50 €	159,99 €

- Alto factor / High factor / Compensé
- Electrónica / Electronic / Électronique
- Regulable / Dimmable / Gradable

2 TUBOS FLUORESCENTES / 2 LAMPS / 2 LAMPES

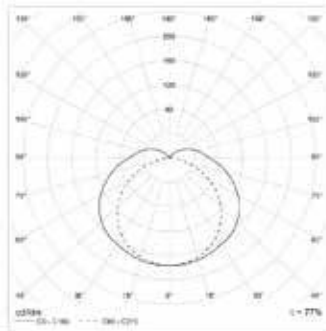

Ref.	Potencia Watts Puissance	Equipo Equipment Ballast	Largo Length Longueur	Raee EU Recyclable tax Ecotaxe	Precio Price Prix
Q0038	18 W	●	713	0,50 €	99,37 €
Q0066	18 W	●	713	0,50 €	139,37 €
Q0039	36 W	●	1.323	0,50 €	116,22 €
Q0067	36 W	●	1.323	0,50 €	156,22 €
Q0040	58 W	●	1.628	0,50 €	126,06 €
Q0068	58 W	●	1.628	0,50 €	166,06 €

- Electrónica / Electronic / Électronique
- Regulable / Dimmable / Gradable



2.2

Luminarias estancas Waterproof luminaires Luminaires étanches

1 TUBO FLUORESCENTE / 1 LAMP / 1 LAMPE

G5
T5

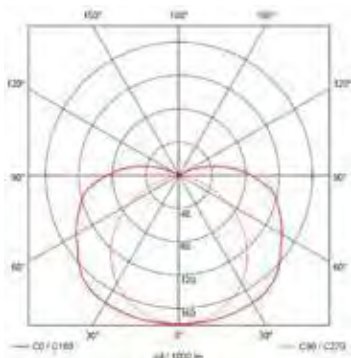

Ref.	Potencia Watts Puissance	Equipo Equipment Ballast	Largo Length Longueur	Raee EU Recyclable tax Ecotaxe	Precio Price Prix
Alta Eficacia / High Efficiency / Haute Efficacité					
Q0051	14 W	●	675	0,50 €	95,20 €
Q0069	14 W	●	675	0,50 €	135,20 €
Q0052	21 W	●	970	0,50 €	104,87 €
Q0070	21 W	●	979	0,50 €	144,87 €
Q0053	28 W	●	1.276	0,50 €	116,70 €
Q0071	28 W	●	1.276	0,50 €	156,70 €
Q0054	35 W	●	1.578	0,50 €	122,64 €
Q0072	35 W	●	1.578	0,50 €	162,64 €
Alto Rendimiento / High Output / Flux Élevé					
Q0089	24 W	●	675	0,50 €	95,20 €
Q0087	24 W	●	675	0,50 €	135,20 €
Q0055	39 W	●	970	0,50 €	104,87 €
Q0073	39 W	●	970	0,50 €	144,87 €
Q0086	49 W	●	1.578	0,50 €	122,64 €
Q0088	49 W	●	1.578	0,50 €	162,64 €
Q0056	54 W	●	1.276	0,50 €	116,70 €
Q0074	54 W	●	1.276	0,50 €	156,70 €
Q0081	80 W	●	1.578	0,50 €	132,09 €
Q0083	80 W	●	1.578	0,50 €	172,09 €

- Electrónica / Electronic / Électronique
- Regulable / Dimmable / Gradable

2 TUBOS FLUORESCENTES / 2 LAMPS / 2 LAMPES

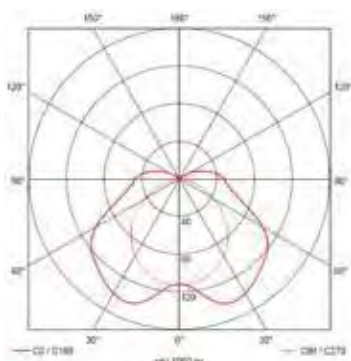

Ref.	Potencia Watts Puissance	Equipo Equipment Ballast	Largo Length Longueur	Raee EU Recyclable tax Ecotaxe	Precio Price Prix
Alta Eficacia / High Efficiency / Haute Efficacité					
Q0057	14 W	●	675	0,50 €	99,27 €
Q0075	14 W	●	675	0,50 €	139,27 €
Q0058	21 W	●	970	0,50 €	109,24 €
Q0076	21 W	●	979	0,50 €	149,24 €
Q0059	28 W	●	1.276	0,50 €	119,58 €
Q0077	28 W	●	1.276	0,50 €	159,58 €
Q0060	35 W	●	1.578	0,50 €	128,64 €
Q0078	35 W	●	1.578	0,50 €	168,64 €
Alto Rendimiento / High Output / Flux Élevé					
Q0092	24 W	●	675	0,50 €	99,21 €
Q0090	24 W	●	675	0,50 €	139,21 €
Q0061	39 W	●	970	0,50 €	109,24 €
Q0079	39 W	●	970	0,50 €	149,24 €
Q0085	49 W	●	1.578	0,50 €	128,64 €
Q0091	49 W	●	1.578	0,50 €	168,64 €
Q0062	54 W	●	1.276	0,50 €	120,08 €
Q0080	54 W	●	1.276	0,50 €	160,08 €

- Electrónica / Electronic / Électronique
- Regulable / Dimmable / Gradable

BAJAS TEMPERATURAS
LOW TEMPERATURES
BASSES TEMPÉRATURES



ES

Características generales

- Cuerpo luminaria: Policarbonato de 1 mm de espesor.
- Tapas: A.B.S.
- Reflector: Aluminio brillante.
- Temperatura de trabajo: De -40° C a 0° C.
- Ensayo hilo incandescente: 850° C.
- Accesorios: 2 bridas de acero cincado antivandálicas y prensaestopas de poliamida PG-11.

Aplicaciones específicas:

- Cámaras frigoríficas.

EN

General characteristics

- Light fitting body: Polycarbonate 1 mm thickness.
- End caps: A.B.S.
- Reflector: Glossy aluminium.
- Working temperature: From -40° C to 0° C.
- Glow wire test: 850° C.
- Accessories: 2 antivandalism zinc plated clamp and PG-11 polyamide cable gland.

Specific applications:

- Freezer rooms.

FR

Caractéristiques générales

- Corps du luminaire: Polycarbonate de 1 mm d'épaisseur.
- Embouts: A.B.S.
- Réflecteur: Aluminium brillant.
- Colliers: Polycarbonate.
- Température d'utilisation: De -40° C à 0° C.
- Essai du fil incandescent: 850° C.
- Accessoires: 2 colliers en acier galvanisé antivandalisme et presse-étoupe PG-11.

Applications spécifiques:

- Entrepôts frigorifiques, chambres froides.

G 13
T8

Ref.	Potencia Watts Puissance	Equipo Equipment Ballast	Largo Length Longueur	Raee EU Recyclable tax Ecotaxe	Precio Price Prix
Q0345	1 x 18 W	●	713	0,50 €	90,62 €
Q0344	1 x 36 W	●	1.323	0,50 €	109,29 €
Q0343	1 x 58 W	●	1.628	0,50 €	123,67 €
Q0342	2 x 18 W	●	713	0,50 €	122,70 €
Q0341	2 x 36 W	●	1.323	0,50 €	145,38 €
Q0340	2 x 58 W	●	1.628	0,50 €	165,63 €

● Alto factor / High factor / Compensé

2.2

Luminarias estancas

Waterproof luminaires

Luminaires étanches

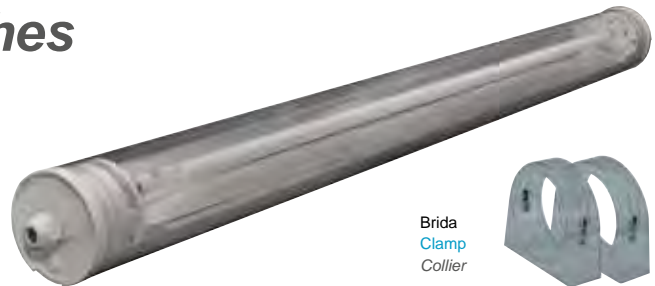

Brida
Clamp
Collier

ES

El modelo TR3 es una luminaria estanca de diseño ofreciendo unas altas prestaciones con una estanqueidad IP67.

Luminaria en policarbonato de 1 mm de espesor y terminales en ABS, se incluyen bridas de sujeción facilitando la labor del montaje del instalador. Esta luminaria posee un grado de protección IP67 que ofrece protección total contra el polvo y contra la penetración de agua en cantidad perjudicial en el interior de la envolvente sumergida en agua, que la hace ideal para su uso en cámaras frigoríficas, viveros, fuentes, piscinas y gimnasios, invernaderos, puentes.

Características generales

- Cuerpo luminaria: Policarbonato bicolor de 1 mm de espesor.
- Tapas: A.B.S.
- Reflector: Aluminio brillante.
- Temperatura de trabajo: Consultar al fabricante del tubo LED.
- Ensayo hilo incandescente: 850° C.
- Accesorios: 2 bridas de policarbonato antivandálicas y prensaestopas de poliamida PG-11.

EN

The TR3 is a high performance designer waterproof luminaire with IP67 water resistance.

1 mm thick polycarbonate and A.B.S. terminals, ceiling clamps included, making installation easier.

This light fixture has a IP67 protection grade, which offers total protection against dust and water seepage in prejudicial quantities in the interior of the cavity submerged in water, which makes it ideal for its use in refrigeration rooms, greenhouses, pools, health clubs and bridges.

General characteristics

- Light fitting body: Polycarbonate two coloured 1 mm thickness.
- End caps: A.B.S.
- Reflector: Glossy aluminium.
- Working temperature: Ask the LED tube manufacturer.
- Glow wire test: 850° C.
- Accessories: 2 antivandalism polycarbonate clamps and PG-11 polyamide cable gland.

FR

Le modèle TR3 est un luminaire étanche de conception offrant de hautes prestations avec une étanchéité IP67.

Luminare en polycarbonate de 1 mm d'épaisseur et embouts en A.B.S., on inclue des colliers de fixation qui facilitent les tâches d'installation de l'installateur.

Excellente conception du luminaire étanche.

Ce luminaire possède un degré de protection IP67 qui offre une protection totale face à la poussière et face à l'eau, ce qui la fait idéale pour son utilisation dans des chambres frigorifiques, pépinières, fontaines, piscines, gymnases, serres, ponts.

Caractéristiques générales

- Corps du luminaire: Polycarbonate bicolore de 1 mm de épaisseur.
- Embouts: A.B.S.
- Réflecteur: Aluminium brillant.
- Colliers: A.B.S.
- Température d'utilisation: Consultez au fabricant du tube LED.
- Essai de fil incandescent: 850° C.
- Accessoires: 2 colliers en polycarbonate antivandalisme et presse-étoupe PG-11.



Ficha técnica
Technical data
Fiche technique

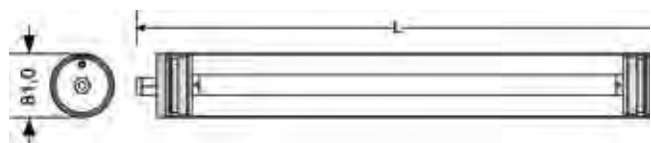

Las luminarias de policarbonato no soportan hidrocarburos

Polycarbonate light fittings don't allow hydrocarbons

Les luminaires de polycarbonate ne supportent pas les hydrocarbures

1 TUBO LED / 1 LED TUBE / 1 TUBE LED

Ref.	Longitud Tubo Tube Length Longueur Tube	Longitud Luminaria Fitting Length Longueur Luminaire	Raee EU Recyclable tax Ecotaxe	Precio Price Prix
Q0035L	600 mms.	713 mms.	0,50 €	82,67 €
Q0010L	900 mms.	1.093 mms.	0,50 €	89,45 €
Q0036L	1.200 mms.	1.323 mms.	0,50 €	97,77 €
Q0037L	1.500 mms.	1.628 mms.	0,50 €	107,99 €

2 TUBOS LED / 2 LED TUBES / 2 TUBES LED

Ref.	Longitud Tubo Tube Length Longueur Tube	Longitud Luminaria Fitting Length Longueur Luminaire	Raee EU Recyclable tax Ecotaxe	Precio Price Prix
Q0038L	600 mms.	713 mms.	0,50 €	87,37 €
Q0041L	900 mms.	1.093 mms.	0,50 €	95,36 €
Q0039L	1.200 mms.	1.323 mms.	0,50 €	104,22 €
Q0040L	1.500 mms.	1.628 mms.	0,50 €	114,06 €



TR3

Parking Hotel Puerta de América, Madrid, España
[Puerta de América Hotel Parking, Madrid, Spain](#)
Parking Hôtel Puerta de America, Madrid, Espagne



TR3

Parking Hotel Puerta de América, Madrid, España
[Puerta de América Hotel Parking, Madrid, Spain](#)
Parking Hôtel Puerta de America, Madrid, Espagne



TR3

Parking Hotel Puerta de América, Madrid, España
Puerta de América Hotel Parking, Madrid, Spain
Parking Hôtel Puerta de America, Madrid, Espagne



2.2

Luminarias estancas Waterproof luminaires Luminaire étanches



Brida
Clamp
Collier

ES

La alternativa decorativa del Modelo TR3.

Características generales

- Cuerpo luminaria: Policarbonato de 1 mm de espesor.
- Tapas: A.B.S.
- Reflector: Aluminio brillante.
- Temperatura de trabajo: De -20° C a +55° C.
- Ensayo hilo incandescente: 850° C.
- Accesorios: 2 bridas de policarbonato antivandálicas y prensaestopas de poliamida PG-11.

EN

Decorative choice for TR3 model.

General characteristics

- Light fitting body: Polycarbonate 1 mm thickness.
- End caps: A.B.S.
- Reflector: Glossy aluminium.
- Working temperature: From -20° C to +55° C.
- Glow wire test: 850° C.
- Accessories: 2 antivandalism polycarbonate clamps and PG-11 polyamide cable gland.

FR

Alternative décorative du modèle TR3.

Caractéristiques générales

- Corps du luminaire: Polycarbonate de 1 mm d'épaisseur.
- Embouts: A.B.S.
- Réflecteur: Aluminium brillant.
- Colliers: Polycarbonate.
- Température d'utilisation: De -20° C à +55° C.
- Essai du fil incandescent: 850° C.
- Accessoires: 2 colliers de polycarbonate antivandalisme et presse-étoupe PG-11.



Ficha técnica
Technical data
Fiche technique

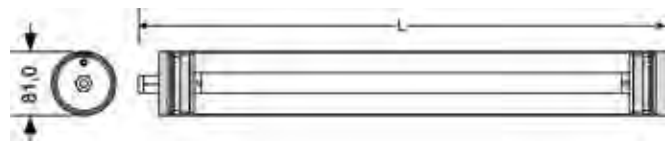

Las luminarias de policarbonato no soportan hidrocarburos
Polycarbonate light fittings don't allow hydrocarbons
Les luminaires de polycarbonate ne supportent pas les hydrocarbures

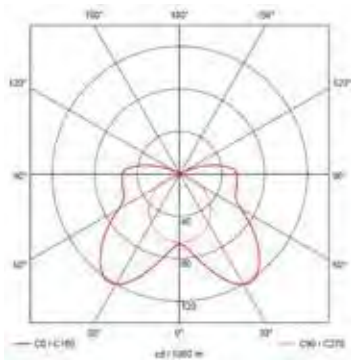

Ref.	Potencia Watts Puissance	Equipo Equipment Ballast	Largo Length Longueur	Raee EU Recyclable tax Ecotaxe	Precio Price Prix
Q0201	18 W	●	713	0,50 €	101,04 €
Q0207	18 W	●	713	0,50 €	141,04 €
Q0202	36 W	●	1.323	0,50 €	121,64 €
Q0208	36 W	●	1.323	0,50 €	161,64 €
Q0203	58 W	●	1.628	0,50 €	132,69 €
Q0209	58 W	●	1.628	0,50 €	172,69 €

- Electrónica / Electronic / Électronique
- Regulable / Dimmable / Gradable

2 TUBOS FLUORESCENTES / 2 LAMPS / 2 LAMPES

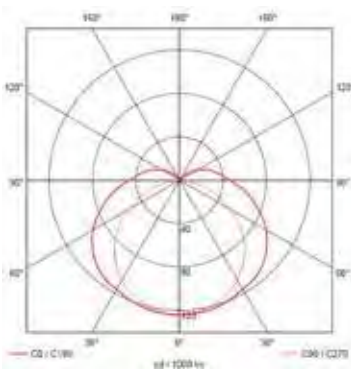

Ref.	Potencia Watts Puissance	Equipo Equipment Ballast	Largo Length Longueur	Raee EU Recyclable tax Ecotaxe	Precio Price Prix
Q0204	18 W	●	713	0,50 €	104,09 €
Q0210	18 W	●	713	0,50 €	144,09 €
Q0205	36 W	●	1.323	0,50 €	127,92 €
Q0211	36 W	●	1.323	0,50 €	167,92 €
Q0206	58 W	●	1.628	0,50 €	141,29 €
Q0212	58 W	●	1.628	0,50 €	181,29 €

- Electrónica / Electronic / Électronique
- Regulable / Dimmable / Gradable



2.2

Luminarias estancas Waterproof luminaires Luminaires étanches

1 TUBO FLUORESCENTE / 1 LAMP / 1 LAMPE

G5
T5

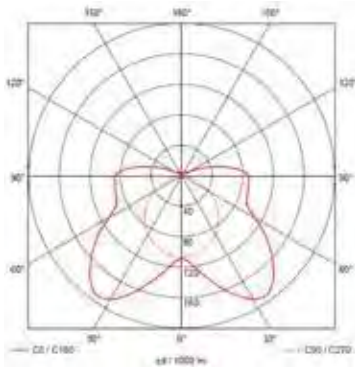

Ref.	Potencia Watts Puissance	Equipo Equipment Ballast	Largo Length Longueur	Raee EU Recyclable tax Ecotaxe	Precio Price Prix
Alta Eficacia / High Efficiency / Haute Efficacité					
Q0213	14 W	●	675	0,50 €	101,51 €
Q0225	14 W	●	675	0,50 €	141,51 €
Q0214	21 W	●	970	0,50 €	113,89 €
Q0226	21 W	●	970	0,50 €	153,89 €
Q0215	28 W	●	1.276	0,50 €	127,73 €
Q0227	28 W	●	1.276	0,50 €	167,73 €
Q0216	35 W	●	1.578	0,50 €	137,64 €
Q0228	35 W	●	1.578	0,50 €	177,64 €
Alto Rendimiento / High Output / Flux Élevé					
Q0237	24 W	●	675	0,50 €	101,51 €
Q0243	24 W	●	675	0,50 €	141,51 €
Q0217	39 W	●	970	0,50 €	113,89 €
Q0229	39 W	●	970	0,50 €	153,89 €
Q0238	49 W	●	1.578	0,50 €	137,64 €
Q0244	49 W	●	1.578	0,50 €	177,64 €
Q0218	54 W	●	1.276	0,50 €	127,73 €
Q0230	54 W	●	1.276	0,50 €	167,73 €
Q0239	80 W	●	1.578	0,50 €	147,30 €
Q0245	80 W	●	1.578	0,50 €	187,30 €

- Electrónica / Electronic / Électronique
- Regulable / Dimmable / Gradable

2 TUBOS FLUORESCENTES / 2 LAMPS / 2 LAMPES

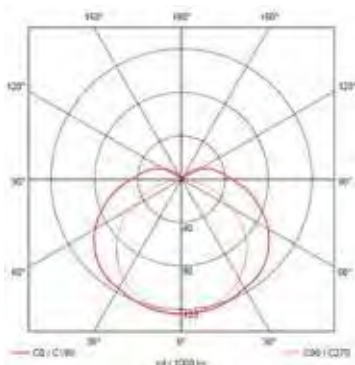

Ref.	Potencia Watts Puissance	Equipo Equipment Ballast	Largo Length Longueur	Raee EU Recyclable tax Ecotaxe	Precio Price Prix
Alta Eficacia / High Efficiency / Haute Efficacité					
Q0219	14 W	●	675	0,50 €	110,73 €
Q0231	14 W	●	675	0,50 €	150,73 €
Q0220	21 W	●	970	0,50 €	120,69 €
Q0232	21 W	●	970	0,50 €	160,69 €
Q0221	28 W	●	1.276	0,50 €	131,41 €
Q0233	28 W	●	1.276	0,50 €	171,41 €
Q0222	35 W	●	1.578	0,50 €	159,33 €
Q0234	35 W	●	1.578	0,50 €	199,33 €
Alto Rendimiento / High Output / Flux Élevé					
Q0240	24 W	●	675	0,50 €	110,73 €
Q0246	24 W	●	675	0,50 €	150,73 €
Q0223	39 W	●	970	0,50 €	120,69 €
Q0235	39 W	●	970	0,50 €	160,69 €
Q0241	49 W	●	1.578	0,50 €	159,33 €
Q0247	49 W	●	1.578	0,50 €	199,33 €
Q0224	54 W	●	1.276	0,50 €	131,41 €
Q0236	54 W	●	1.276	0,50 €	171,41 €

- Electrónica / Electronic / Électronique
- Regulable / Dimmable / Gradable



TR3 Opal / Matte / Opale

Parking Hotel Puerta de América, Madrid, España

[Puerta de América Hotel Parking, Madrid, Spain](#)

[Parking Hôtel Puerta de America, Madrid, Espagne](#)

2.2

Luminarias estancas Waterproof luminaires Luminaires étanches



Brida
Clamp
Collier

ES

La alternativa decorativa del Modelo TR3.

Características generales

- Cuerpo luminaria: Policarbonato de 1 mm de espesor.
- Tapas: A.B.S.
- Reflector: Aluminio brillante.
- Temperatura de trabajo: Consultar al fabricante del tubo LED
- Ensayo hilo incandescente: 850° C.
- Accesorios: 2 bridas de policarbonato antivandálicas y prensaestopas de poliamida PG-11.

EN

Decorative choice for TR3 model.

General characteristics

- Light fitting body: Polycarbonate 1 mm thickness.
- End caps: A.B.S.
- Reflector: Glossy aluminium.
- Working temperature: Ask the LED tube manufacturer.
- Glow wire test: 850° C.
- Accessories: 2 antivandalism polycarbonate clamps and PG-11 polyamide cable gland.

FR

Alternative décorative du modèle TR3.

Caractéristiques générales

- Corps du luminaire: Polycarbonate de 1 mm d'épaisseur.
- Embouts: A.B.S.
- Réflecteur: Aluminium brillant.
- Colliers: Polycarbonate.
- Température d'utilisation: Consultez au fabricant de tube LED
- Essai du fil incandescent: 850° C.
- Accessoires: 2 colliers de polycarbonate antivandalisme et presse-étoupe PG-11.



Ficha técnica
Technical data
Fiche technique

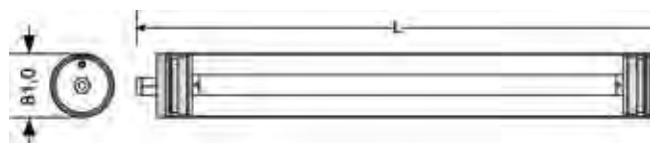

Las luminarias de policarbonato no soportan hidrocarburos

Polycarbonate light fittings don't allow hydrocarbons

Les luminaires de polycarbonate ne supportent pas les hydrocarbures

1 TUBO LED / 1 LED TUBE / 1 TUBE LED

Ref.	Longitud Tubo Tube Length Longueur Tube	Longitud Luminaria Fitting Length Longueur Luminaire	Raee EU Recyclable tax Ecotaxe	Precio Price Prix
Q0201L	600 mms.	713 mms.	0,50 €	89,04 €
Q0207L	900 mms.	1.093 mms.	0,50 €	99,34 €
Q0202L	1.200 mms.	1.323 mms.	0,50 €	109,64 €
Q0203L	1.500 mms.	1.628 mms.	0,50 €	120,69 €

2 TUBOS LED / 2 LED TUBES / 2 TUBES LED

Ref.	Longitud Tubo Tube Length Longueur Tube	Longitud Luminaria Fitting Length Longueur Luminaire	Raee EU Recyclable tax Ecotaxe	Precio Price Prix
Q0204L	600 mms.	713 mms.	0,50 €	92,09 €
Q0208L	900 mms.	1.093 mms.	0,50 €	104,01 €
Q0205L	1.200 mms.	1.323 mms.	0,50 €	115,92 €
Q0206L	1.500 mms.	1.628 mms.	0,50 €	129,29 €



2.2

Luminarias estancas Waterproof luminaires Luminaires étanches

ACCESORIOS TR3 / TR3 ACCESSORIES / ACCESSOIRES TR3

REF. Q0155

9,26 €



Brida de policarbonato
antivandálica (2 unidades)
Antivandalic polycarbonate
clamp (2 units)
Colliers en polycarbonate
antivandalisme (2 uts.)

REF. Q0338

9,63 €



Bridas de acero cincado
(incremento de precio 2 uds.)
Zinc-plated steel clamps
(price increase 2 units.)
Colliers en acier galvanisé
(plus value de prix 2 uts.)

REF. Q0348

7,25 €



Bridas de acero inoxidable de
apertura rápida
(incremento de precio 2 uds.)
Quick opening stainless steel
clamps (price increase 2 units.)
Colliers inox de ouverture rapide à
grenouillère (plus value de prix 2 uts.)

REF. Q0347

18,21 €



Bridas de acero inoxidable
(incremento de precio 2 uds.)
Stainless steel clamps
(price increase 2 units.)
Colliers inox antivandalisme
(plus value de prix 2 uts.)

REF. Q0349

12,21 €



Suspensión con cable de acero
Steel cable suspension
Suspension avec câble en acier

REF. Q0339

37,41 €



Tapas metálicas y racor metálico
(incremento de precio 2 uds.)
Metallic end caps and
nickel-plated gland (price increase
2 units.)
Embouts et presse-étoupe
métallique (plus value de prix 2 uts.)

REF. Q0161

17,22 €



Válvula anticondensación y de
equilibrado de presión
Anticondensation valve and
pressure balancing
Valve anti-condensation et
équilibrage de pression

REF. Q0351

47,40 €



Opción conexión rápida IP68
Incluye tubos fluorescentes
Quick IP68 connection option
Fluorescent lamps included
Option connectique rapide IP68
Lampes inclus

REF. QCLA2

23,80 €



CLASE II

Posibilidad de Clase II
Available for Class II
Possibilité de Classe II

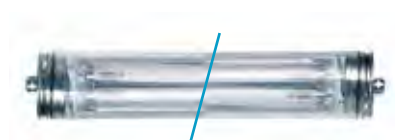

Opción línea continua
Continuous line option
Câblage traversant

3 polos / 3 poles / 3 pôles

REF. Q0350

19,36 €

5 polos / 5 poles / 5 pôles

REF. Q0361

32,80 €

Reflectores especiales en página 119
Special reflectors in page 119
Réfecteurs spéciaux en page 119

2.2 Luminarias estancas Waterproof luminaires Luminaires étanches

REFLECTOR INTENSIVO INTENSIVE REFLECTOR RÉFLECTEURS INTENSIF

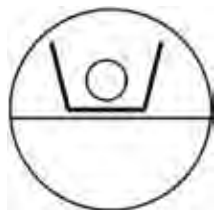

Potencia Watts Puissance	Ref.	Precio Price Prix
1 x 14 / 24 W	Q0276	12,61 €
1 x 21 / 39 W	Q0277	14,80 €
1 x 28 / 54 W	Q0278	17,06 €
1 x 35 / 49 / 80 W	Q0279	20,27 €

Especial para obtener mayor concentración de luz

Special for more concentration of light

Spécial pour une plus grande concentration de la lumière

REFLECTOR ASIMÉTRICO CERRADO ASYMMETRICAL REFLECTOR CLOSED RÉFLECTEURS ASYMÉTRIQUE FERMÉ

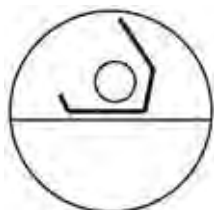

Potencia Watts Puissance	Ref.	Precio Price Prix
1 x 14 / 24 W	Q0280	12,06 €
1 x 21 / 39 W	Q0281	14,02 €
1 x 28 / 54 W	Q0282	15,58 €
1 x 35 / 49 / 80 W	Q0283	18,31 €

Especial para obtener efectos de "baño" sobre paredes

Special effects for "flood effect" on walls

Les effets spéciaux pour «bain» sur les murs

REFLECTOR ASIMÉTRICO ABIERTO ASYMMETRICAL OPEN REFLECTOR RÉFLECTEURS ASYMÉTRIQUE OUVERT



Potencia Watts Puissance	Ref.	Precio Price Prix
1 x 14 / 24 W	Q0284	11,13 €
1 x 21 / 39 W	Q0285	13,08 €
1 x 28 / 54 W	Q0286	14,64 €
1 x 35 / 49 / 80 W	Q0287	17,38 €

Reflector asimétrico de mayor dispersión óptica que el anterior.

Utilización recomendada: expositores, áreas de trabajo.

Asymmetrical reflector optical dispersion higher than the previous. Recommended use: exhibitors, Workspaces.

Dispersion asymétrique réflecteur optique plus élevée que la dernière. Utilisation recommandée: zones d'affichage de travail.

Válidos para los modelos Rinox, Resist, TR2 y TR3.

For models Rinox, Resist, TR2 and TR3.

Valide pour modèles Rinox, TR2 et TR3.



TR4 OPAL LED

Cueva de las Gúisas, Villanua, España

[Witches Cave, Villanua, Spain](#)

Grotte des Sorcières, Villanua, Espagne

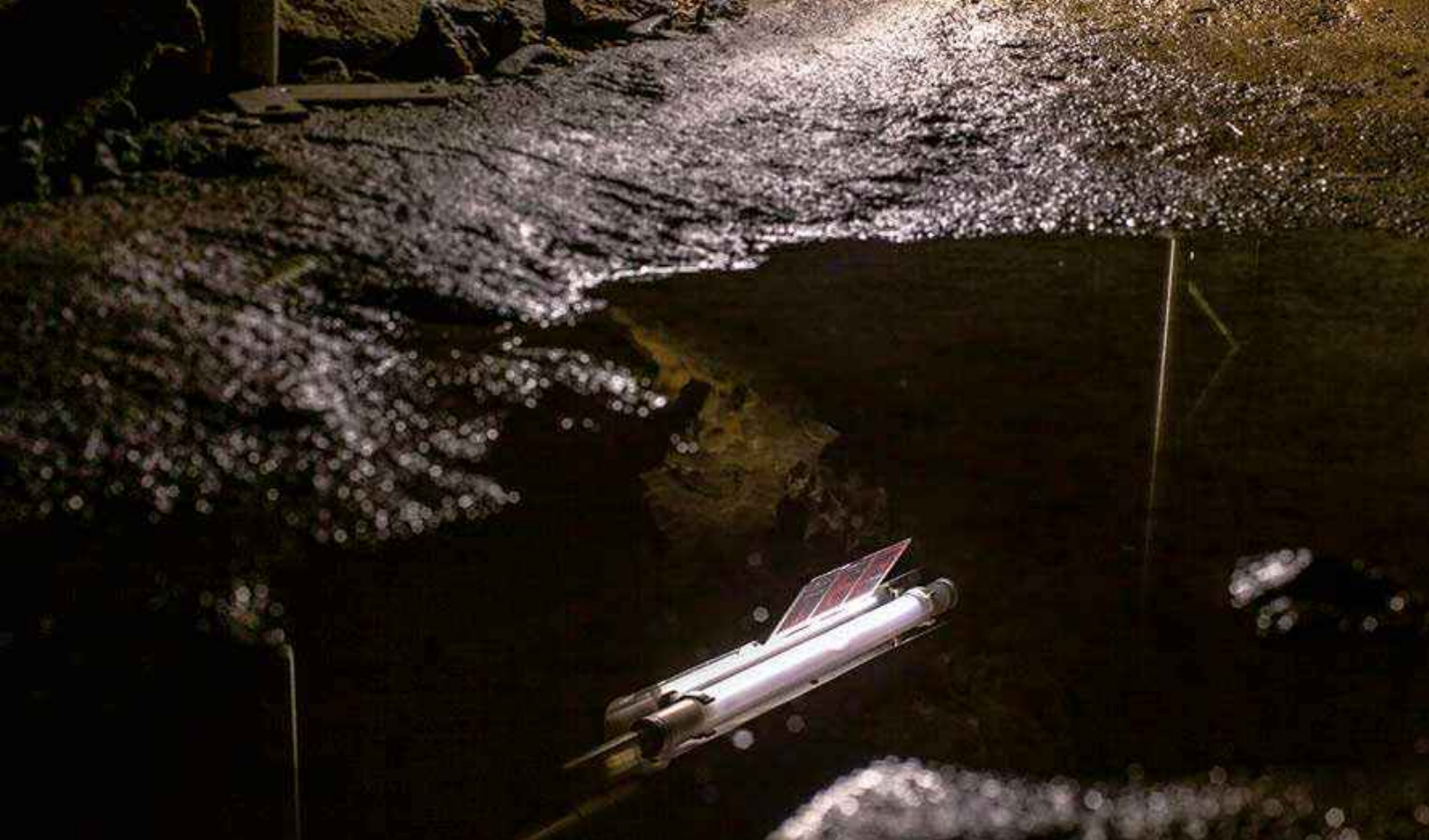

TR4 OPAL LED

Cueva de las Güisas, Villanua, España
[Witches Cave, Villanua, Spain](#)
Grotte des Sorcières, Villanua, Espagne



TR4 OPAL LED

Cueva de las Güisas, Villanua, España
[Witches Cave, Villanua, Spain](#)
Grotte des Sorcières, Villanua, Espagne



2.2

Luminarias estancas

Waterproof luminaires

Luminaires étanches



Brida
Clamp
Collier

ES

Siguiendo la línea de la luminaria TR3, el modelo TR4 ofrece un amplio abanico de posibilidades gracias a sus reducidas dimensiones, manteniendo una excelente estanqueidad IP67.

Para casos en los que el espacio disponible sea muy reducido, **existe la posibilidad de realizar modelos asimétricos**, reduciendo así la longitud de la luminaria.

Esta luminaria posee un grado de protección IP67 que ofrece protección total para el polvo y contra la penetración en cantidad perjudicial en el interior de la envolvente sumergida en agua, que la hace ideal para su uso en viveros, fuentes, piscinas, invernaderos, spas, etc.

Características generales

- Cuerpo luminaria: Policarbonato de 1 mm de espesor con vinilo en los extremos (RAL 9016).
- Tapas: A.B.S.
- Reflector: Aluminio lacado.
- Temperatura de trabajo: De -20° C a +55° C.
- Accesorios: 2 bridas de sujeción de A.B.S. y prensaestopas de poliámi-da PG-11 (incluidos).
- Ensayo hilo incandescente: 850° C.

EN

In the same line as the TR3, the TR4 can be used for a wide range of purposes, as it is smaller but retains an excellent IP67 water proofing index. For situations in which space is limited, **it is possible to produce asymmetrical models**, thus reducing the length of the light fitting.

This light fixture has IP67 protection degree, that offers a shield against dust and water penetration in prejudicial quantities inside the incapsulate submerged in water, which makes it ideal for its utilization in nurseries, fountains, pools, greenhouses, spas, etc.

General characteristics

- Light fitting body: Polycarbonate 1 mm thickness with vinyl at the ends (RAL 9016).
- End caps: A.B.S.
- Reflector: Aluminium lacquered.
- Working temperature: From -20° C to +55° C.
- Accessories: 2 A.B.S. sujection clamps and PG-11 polyamide cable gland (included).
- Glow wire test: 850° C.

FR

Suivant la ligne du luminaire TR3, le modèle TR4 offre beaucoup de possibilités grâce à ses petites dimensions, en maintenant une excellente étanchéité.

Pour les situations d'encombrements réduits, **il existe la possibilité de réaliser des modèles asymétriques**, en réduisant la longueur du luminaire.

Ce luminaire possède un degré de protection IP67 qui offre une protection total face à la poussière et face à l'eau, ce qui la fait idéale pour son utilisation dans des pépinières, fontaines, piscines, serres, spas, etc.

Caractéristiques générales

- Corps du luminaire: Polycarbonate de 1 mm de épaisseur avec finitions opaques (RAL 9016).
- Embouts: A.B.S.
- Réflecteur: Aluminium laqué.
- Colliers: A.B.S.
- Température d'utilisation: De -20° C à +55° C.
- Accessoires: 2 colliers de fixation en A.B.S. y presse-étoupe PG-11 (inclus).
- Essai du fil incandescent: 850° C.



Ficha técnica
Technical data
Fiche technique

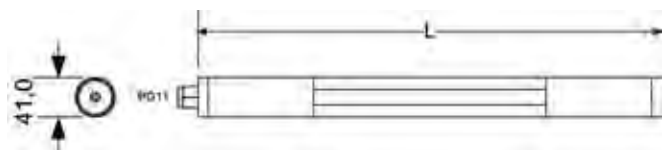

Las luminarias de policarbonato no soportan hidrocarburos

Polycarbonate light fittings don't allow hydrocarbons

Les luminaires de polycarbonate ne supportent pas les hydrocarbures

1 TUBO FLUORESCENTE / 1 LAMP / 1 LAMPE

G 13
T8

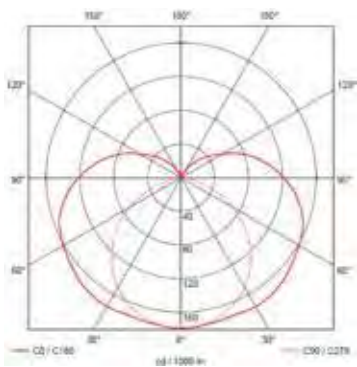

- Electrónica / Electronic / Électronique
- Regulable / Dimmable / Gradable

Ref.	Potencia Watts Puissance	Equipo Equipment Ballast	Largo Length Longueur	Raee EU Recyclable tax Ecotaxe	Precio Price Prix
R0015	18 W	●	1.080	0,50 €	87,64 €
R0022	18 W	●	***	0,50 €	127,64 €
R0016	36 W	●	1.940	0,50 €	133,62 €
R0023	36 W	●	***	0,50 €	173,62 €
R0017	58 W	●	2.240	0,50 €	138,83 €
R0024	58 W	●	***	0,50 €	178,83 €

*** Consultar / Consult / Consulter

1 TUBO FLUORESCENTE / 1 LAMP / 1 LAMPE

G 5
T5



- Electrónica / Electronic / Électronique
- Regulable / Dimmable / Gradable

Ref.	Potencia Watts Puissance	Equipo Equipment Ballast	Largo Length Longueur	Raee EU Recyclable tax Ecotaxe	Precio Price Prix
Alta Eficacia / High Efficiency / Haute Efficacité					
R0051	14 W	●	1.038	0,50 €	93,58 €
R0025	14 W	●	***	0,50 €	133,58 €
R0052	21 W	●	1.335	0,50 €	103,26 €
R0026	21 W	●	***	0,50 €	143,26 €
R0053	28 W	●	1.800	0,50 €	129,59 €
R0027	28 W	●	***	0,50 €	169,59 €
R0054	35 W	●	2.100	0,50 €	132,79 €
R0028	35 W	●	***	0,50 €	172,79 €
Alto Rendimiento / High Output / Flux Élevé					
R0031	24 W	●	1.038	0,50 €	90,80 €
R0034	24 W	●	***	0,50 €	130,80 €
R0055	39 W	●	1.510	0,50 €	122,89 €
R0029	39 W	●	***	0,50 €	162,89 €
R0032	49 W	●	2.100	0,50 €	134,83 €
R0035	49 W	●	***	0,50 €	174,83 €
R0056	54 W	●	1.800	0,50 €	130,56 €
R0030	54 W	●	***	0,50 €	170,56 €
R0033	80 W	●	2.330	0,50 €	142,66 €
R0036	80 W	●	***	0,50 €	182,66 €

*** Consultar / Consult / Consulter

Esta luminaria se puede fabricar en diferentes colores.
Consultar precio y disponibilidad.

This light fitting can be made in different colours.
Ask for price and availability.

Ce luminaire peut être fabriqué en différentes couleurs.
Vérifier le prix et la disponibilité.



2.2

Luminarias estancas

Waterproof luminaires

Luminaires étanches



Brida
Clamp
Collier

ALUMINIO / ALUMINIUM / ALUMINIUM

ES

Características generales

- Cuerpo luminaria: Policarbonato de 1 mm de espesor con vinilo en los extremos (RAL 9006).
- Tapas: A.B.S.
- Reflector: Aluminio lacado.
- Temperatura de trabajo: De -20° C a +55° C.
- Accesorios: 2 bridas de sujeción de A.B.S. y prensaestopas de poliámi-da PG-11 (incluidos).
- Ensayo hilo incandescente: 850° C.

EN

General characteristics

- Light fitting body: Polycarbonate 1 mm thickness with vinyl at the ends (RAL 9006).
- End caps: A.B.S.
- Reflector: Aluminium.
- Working temperature: From -20° C to +55° C.
- Accessories: 2 A.B.S. sujection clamps and PG-11 polyamide cable gland (included).
- Glow wire test: 850° C.

FR

Caractéristiques générales

- Corps du luminaire: Polycarbonate de 1 mm d'épaisseur avec finitions opaques (RAL 9006).
- Embouts: A.B.S.
- Reflector: Aluminium laqué.
- Colliers: A.B.S.
- Température d'utilisation: De -20° C à +55° C.
- Accessoires: 2 colliers de fixation en plastique et presse-étoupe PG-11 (inclus).
- Essai du fil incandescent: 850° C.



Ficha técnica
Technical data
Fiche technique

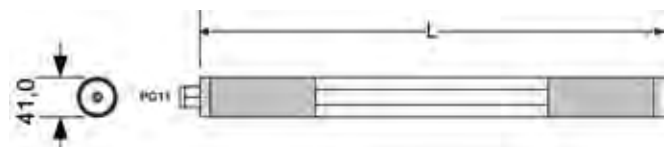

Las luminarias de policarbonato no soportan hidrocarburos

Polycarbonate light fittings don't allow hydrocarbons

Les luminaires de polycarbonate ne supportent pas les hydrocarbures

1 TUBO FLUORESCENTE / 1 LAMP / 1 LAMPE

G 13
T8



- Electrónica / Electronic / Électronique
- Regulable / Dimmable / Gradable

Ref.	Potencia Watts Puissance	Equipo Equipment Ballast	Largo Length Longueur	Raee EU Recyclable tax Ecotaxe	Precio Price Prix
R0115	18 W	●	1.080	0,50 €	91,51 €
R0118	18 W	●	***	0,50 €	131,51 €
R0116	36 W	●	1.940	0,50 €	127,65 €
R0119	36 W	●	***	0,50 €	167,65 €
R0117	58 W	●	2.240	0,50 €	137,95 €
R0120	58 W	●	***	0,50 €	177,95 €

*** Consultar / Consult / Consulter

1 TUBO FLUORESCENTE / 1 LAMP / 1 LAMPE

G 5
T5



- Electrónica / Electronic / Électronique
- Regulable / Dimmable / Gradable

Ref.	Potencia Watts Puissance	Equipo Equipment Ballast	Largo Length Longueur	Raee EU Recyclable tax Ecotaxe	Precio Price Prix
Alta Eficacia / High Efficiency / Haute Efficacité					
R0151	14 W	●	1.038	0,50 €	98,26 €
R0157	14 W	●	***	0,50 €	138,26 €
R0152	21 W	●	1.335	0,50 €	118,28 €
R0126	21 W	●	***	0,50 €	158,28 €
R0153	28 W	●	1.800	0,50 €	134,32 €
R0158	28 W	●	***	0,50 €	174,32 €
R0154	35 W	●	2.100	0,50 €	145,63 €
R0159	35 W	●	***	0,50 €	185,63 €
Alto Rendimiento / High Output / Flux Élevé					
R0161	24 W	●	1.038	0,50 €	93,24 €
R0165	24 W	●	***	0,50 €	133,24 €
R0155	39 W	●	1.510	0,50 €	129,03 €
R0169	39 W	●	***	0,50 €	169,03 €
R0163	49 W	●	2.100	0,50 €	145,46 €
R0167	49 W	●	***	0,50 €	185,46 €
R0156	54 W	●	1.800	0,50 €	137,09 €
R0160	54 W	●	***	0,50 €	177,09 €
R0164	80 W	●	2.330	0,50 €	147,52 €
R0168	80 W	●	***	0,50 €	187,52 €

*** Consultar / Consult / Consulter

Esta luminaria se puede fabricar en diferentes colores.
Consultar precio y disponibilidad.

This light fitting can be made in different colours.
Ask for price and availability.

Ce luminaire peut être fabriqué en différentes couleurs.
Vérifier le prix et la disponibilité.

2.2

Luminarias estancas Waterproof luminaires Luminaires étanches

OPAL / MATTE / OPALE

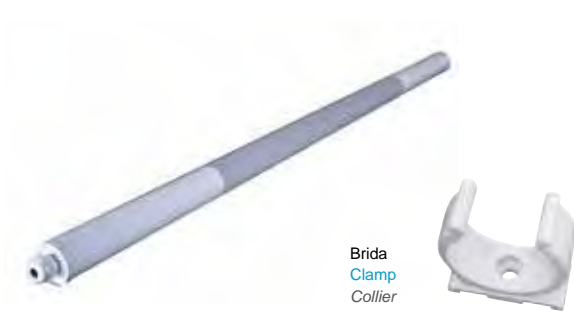

Brida
Clamp
Collier

Potencia Watts Puissance	Aumento precio Price increase Plus value
18 W	2,53 €
36 W	4,55 €
58 W	5,25 €
14-24 W	2,43 €
21 W	3,13 €
28-54 W	4,22 €
35-49 W	4,92 €
39 W	3,54 €
80 W	5,46 €

Ref luminaria + "O". Ej.: R0015O
 Light fitting ref + "O". Ex.:R0015O
 Ref luminaire + "O". Ex.: R0015O



Ficha técnica
 Technical data
 Fiche technique

Las luminarias de policarbonato no soportan hidrocarburos

Polycarbonate light fittings don't allow hydrocarbons

Les luminaires de polycarbonate ne supportent pas les hydrocarbures



BLANCO / WHITE / BLANC



OPAL / MATTE / OPALE

 Brida
Clamp
Collier

ES

Características generales

- Cuerpo luminaria: Policarbonato transparente de 1 mm de espesor con vinilo en los extremos. (RAL 9016 blanco o RAL 9006 aluminio) u opal sin vinilo.
- Tapas: A.B.S.
- Reflector: Aluminio lacado.
- Temperatura de trabajo: Consultar al fabricante del tubo LED.
- Accesorios: 2 bridas de sujeción de A.B.S. y prensaestopas de poliamida PG-11 (incluidos).
- Ensayo hilo incandescente: 850° C.

EN

General characteristics

- Light fitting body: Transparent polycarbonate 1 mm thickness with vinyl at the ends. (RAL 9016 white and RAL 9006 aluminium) or matte without vinyl.
- End caps: A.B.S.
- Reflector: Aluminium.
- Working temperature: Ask the LED tube manufacturer.
- Accessories: 2 A.B.S. sujection clamps and PG-11 polyamide cable gland (included).
- Glow wire test: 850° C.

FR

Caractéristiques générales

- Corps du luminaire: Polycarbonate transparent de 1 mm d'épaisseur avec finitions opaques (RAL 9016 blanc ou RAL 9006 aluminium) ou opale sans finitions
- Embouts: A.B.S.
- Réflecteur: Aluminium laqué.
- Colliers: A.B.S.
- Température d'utilisation: Consultez au fabricant du tube LED.
- Accessoires: 2 colliers de fixation en plastique et presse-étoupe PG-11 (inclus).
- Essai du fil incandescent: 850° C.

 G 13
T8

Ref.	Longitud Tubo Tube Length Longueur Tube	Longitud Luminaria Fitting Length Longueur Luminaire	Raee EU Recyclable tax Ecotaxe	Precio Price Prix
R0015L	600 mms.	780 mms.	0,50 €	75,64 €
R0014L	900 mms.	1.080 mms.	0,50 €	98,63 €
R0016L	1.200 mms.	1.380 mms.	0,50 €	121,62 €
R0017L	1.500 mms.	1.680 mms.	0,50 €	126,83 €

ALUMINIO / ALUMINIUM / ALUMINIUM

Ref.	Longitud Tubo Tube Length Longueur Tube	Longitud Luminaria Fitting Length Longueur Luminaire	Raee EU Recyclable tax Ecotaxe	Precio Price Prix
R0115L	600 mms.	780 mms.	0,50 €	79,51 €
R0114L	900 mms.	1.080 mms.	0,50 €	94,53 €
R0116L	1.200 mms.	1.380 mms.	0,50 €	115,55 €
R0117L	1.500 mms.	1.680 mms.	0,50 €	125,95 €

OPAL / MATTE / OPALE

Ref.	Longitud Tubo Tube Length Longueur Tube	Longitud Luminaria Fitting Length Longueur Luminaire	Raee EU Recyclable tax Ecotaxe	Precio Price Prix
R0201L	600 mms.	780 mms.	0,50 €	78,71 €
R0204L	900 mms.	1.080 mms.	0,50 €	102,17 €
R0202L	1.200 mms.	1.380 mms.	0,50 €	126,17 €
R0203L	1.500 mms.	1.680 mms.	0,50 €	132,08 €



2.2

Luminarias estancas Waterproof luminaires Luminaires étanches

ACCESORIOS TR4 / TR4 ACCESSORIES / ACCESSOIRES TR4

REF. R0057

21,37 €



Bridas de acero inoxidable
(incremento de precio 2 uds.)
Stainless steel clamps
(price increase 2 units.)
Colliers inox antivandalisme
(plus value de prix 2 uts.)

REF. R0063

35,99 €



Tapas metálicas y racor metálico
(incremento de precio 2 uds.)
Metallic end caps and nickel-plated gland
(price increase 2 units.)
Embouts métalliques et presseétoupe
(plus value de prix 2 uts.)

REF. Q0349

12,21 €



Suspensión con cable de acero
Steel cable suspension
Suspension avec câble en acier



Opción línea continua
Continuous line option
Câblage traversant

3 polos / 3 poles / 3 pôles

REF. R0058

16,22 €

5 polos / 5 poles / 5 pôles

REF. R0064

29,28 €



TR4

Residencia Can Travi, Barcelona, España. Luminaria TR4
Retirement home Can Travi, Barcelona, Spain. TR4 luminaire
Maison de retraite Can Travi, Barcelona, Espagne. Luminaire TR4



TR4

Residencia Can Travi, Barcelona, España. Luminaria TR4
Retirement home Can Travi, Barcelona, Spain. TR4 luminaire
Maison de retraite Can Travi, Barcelona, Espagne. Luminaire TR4



2.2

Luminarias estancas Waterproof luminaires Luminaires étanches



Brida
Clamp
Collier

ALUMINIO / ALUMINIUM / ALUMINIUM

ES

Luminaria estanca tubular de alta calidad y estanqueidad. Especialmente diseñada para espacios reducidos en los que se requiera menores dimensiones y no tener partes ciegas. Gracias a su material constructivo esta luminaria es IK10 en T5, el mayor grado de protección contra impacto aplicable a luminarias. Ésta ofrece un amplio abanico de posibilidades gracias a sus reducidas dimensiones, manteniendo una excelente estanqueidad IP67. Posee un grado de protección que garantiza la no penetración de agua en una cantidad que pueda ser perjudicial, una vez sumergida en agua y contra el polvo. Esto la hace ideal para su uso en viveros, fuentes, piscinas, invernaderos, spas, etc.

Características generales

- Cuerpo luminaria: Policarbonato opal de 2,5 mm de espesor.
- Tapas: A.B.S.
- Reflector: Aluminio lacado.
- Temperatura de trabajo: De -20° C a +50° C.
- Accesorios: 4 bridas de sujeción de A.B.S. y 3 prensaestopas de poliamida PG-11 (incluidos).
- Ensayo hilo incandescente: 850° C.

EN

High quality tubular waterproof luminaire. Specially designed for small spaces requiring reduced size with no blind parts. Thanks to the material it is made from, this luminaire is IK10 in T5, the highest level of shockproofing applicable to luminaires. This offers a wide range of possibilities thanks to its small size, while maintaining an excellent water proofing index of IP67. It possesses a degree of protection that guarantees the nonpenetration of water in potentially harmful quantities when submerged in water and protection against dust, making it ideal for use in garden centres, fountains, swimming pools, greenhouses, spas, etc.

General characteristics

- Light fitting body: Matte polycarbonate 2,5 mm thickness.
- End caps: A.B.S.
- Reflector: Aluminium lacquered.
- Working temperature: From -20° C to +50° C.
- Accessories: 4 A.B.S. sujection clamps and 3 PG-11 polyamide cable gland (included).
- Glow wire test: 850° C.

FR

Luminaire tubulaire étanche de grande qualité et offrant une très bonne étanchéité. Spécialement conçu pour les espaces réduits exigeant de petites dimensions et l'absence de parties aveugles. Grâce à son matériau de fabrication, ce luminaire possède un degré de protection IK10 en T5, le plus important degré de protection contre les chocs applicable aux luminaires. Il offre un large éventail de possibilités grâce à ses petites dimensions, en conservant une excellente étanchéité IP67. Il possède un degré de protection qui garantit la non pénétration d'eau dans une quantité pouvant être préjudiciable une fois immergée dans l'eau et contre la poussière. Cela le rend idéal pour une utilisation en viviers, fontaines, piscines, serres, spas, etc.

Caractéristiques générales

- Corps du luminaire: Polycarbonate opale de 2,5 mm d'épaisseur.
- Embouts: A.B.S.
- Réflecteur: Aluminium laqué.
- Colliers: A.B.S.
- Température d'utilisation: De -20° C à +50° C.
- Accessoires: 4 colliers de fixation en plastique et 3 presse-étoupes PG-11 (inclus).
- Essai du fil incandescent: 850° C.



Ficha técnica
Technical data
Fiche technique

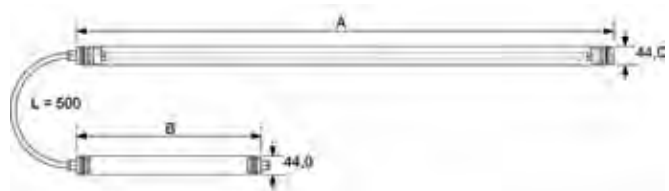

1 TUBO FLUORESCENTE / 1 LAMP / 1 LAMPE

IK8 G13 T8

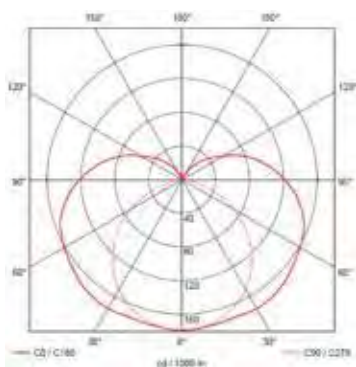

- Electrónica / Electronic / Électronique
- Regulable / Dimmable / Gradable

Ref.	Potencia Watts Puissance	Equipo Equipment Ballast	Largo Length Longueur	Raee EU Recyclable tax Ecotaxe	Precio Price Prix
R0201	18 W	●	745 + 245	0,50 €	105,05 €
R0204	18 W	●	745 + 245	0,50 €	145,05 €
R0202	36 W	●	1.355 + 440	0,50 €	153,25 €
R0205	36 W	●	1.355 + 440	0,50 €	193,25 €
R0203	58 W	●	1.655 + 440	0,50 €	165,28 €
R0206	58 W	●	1.655 + 440	0,50 €	205,28 €

2 TUBOS FLUORESCENTES / 2 LAMPS / 2 LAMPES

IK10 G5 T5



- Electrónica / Electronic / Électronique
- Regulable / Dimmable / Gradable

Ref.	Potencia Watts Puissance	Equipo Equipment Ballast	Largo Length Longueur	Raee EU Recyclable tax Ecotaxe	Precio Price Prix
Alta Eficacia / High Efficiency / Haute Efficacité					
R0207	14 W	●	692 + 245	0,50 €	148,83 €
R0216	14 W	●	692 + 245	0,50 €	188,83 €
R0208	21 W	●	992 + 245	0,50 €	117,26 €
R0217	21 W	●	992 + 245	0,50 €	157,26 €
R0209	28 W	●	1.292 + 440	0,50 €	147,32 €
R0218	28 W	●	1.292 + 440	0,50 €	187,32 €
R0210	35 W	●	1.592 + 440	0,50 €	158,56 €
R0219	35 W	●	1.592 + 440	0,50 €	198,56 €
Alto Rendimiento / High Output / Flux Élevé					
R0211	24 W	●	692 + 245	0,50 €	103,83 €
R0220	24 W	●	692 + 245	0,50 €	143,83 €
R0212	39 W	●	992 + 245	0,50 €	134,52 €
R0221	39 W	●	992 + 245	0,50 €	174,52 €
R0213	49 W	●	1.592 + 440	0,50 €	158,48 €
R0222	49 W	●	1.592 + 440	0,50 €	198,48 €
R0214	54 W	●	1.292 + 440	0,50 €	147,32 €
R0223	54 W	●	1.292 + 440	0,50 €	187,32 €
R0215	80 W	●	1.592 + 440	0,50 €	172,95 €
R0224	80 W	●	1.592 + 440	0,50 €	212,95 €

ACCESORIOS COMPACT / COMPACT ACCESSORIES / ACCESSOIRES COMPACT

REF. R0057

21,37 €



Bridas de acero inoxidable
(incremento de precio 2 uds.)
Stainless steel clamps
(price increase 2 units.)
Colliers inox antivandalisme
(plus value de prix 2 uts.)

REF. R0063

35,99 €



Tapas metálicas y racor metálico
(incremento de precio 2 uds.)
Metallic end caps and nickel-plated gland
(price increase 2 units.)
Embouts métalliques et presseétoupe
(plus value de prix 2 uts.)

2.2

Luminarias estancas

Waterproof luminaires

Luminaires étanches

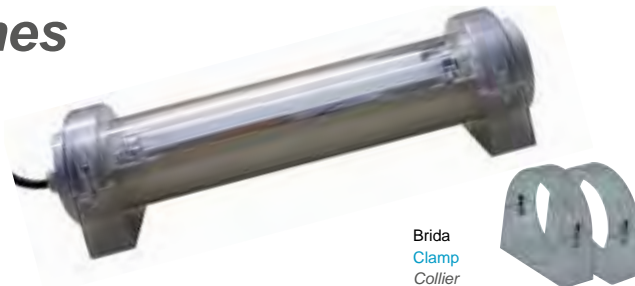
**ES**

Luminaria autónoma de emergencia, con posibilidad de puesta en reposo a distancia (telemando) y apta para montaje en superficie. Su grado de estanqueidad IP67 le confiere protección total contra penetración de polvo y contra penetración de líquidos hasta en inmersión momentánea.

Esta estanca es apropiada para aplicaciones industriales, agrícolas, lugares de pública concurrencia, túneles y áreas de evacuación de infraestructuras públicas.

Gracias a su diseño cilíndrico sus aplicaciones se amplían abarcando instalaciones comerciales, parkings y obras emblemáticas.

Características generales

- Cuerpo luminaria: Policarbonato bicolor de 1 mm de espesor.
- Tapas: A.B.S.
- Reflector: Aluminio brillante.
- Temperatura de trabajo: De -0° C a +45° C.
- Ensayo hilo incandescente: 850° C.
- Lámpara: T5 8 W.
- Batería: 3,6 V; 1500 mAh; 3 celdas de Ni/Cd. Tiempo de carga: 24 horas.
- Accesorios: 2 bridas de policarbonato antivandálicas y prensaestopas de poliamida PG-11.

EN

Emergency autonomous luminaire, with the possibility of remote standby (remote controlled) and fit to be surface mounted. Its waterproofing grade IP67 gives it total protection against dust penetration and liquid penetration until sudden immersion.

This light fitting is appropriated for industrial applications, farming, public places, tunnels and public evacuation areas.

Thanks to its cylindrical design its applications extend including commercial installations, parking lots and important works.

General characteristics

- Light fitting body: Polycarbonate two coloured 1 mm thickness.
- End caps: A.B.S.
- Reflector: Glossy aluminium.
- Working temperature: From -0° C to +45° C.
- Glow wire test: 850° C.
- Battery: 3,6 V; 1500 mAh; 3 Ni/Cd cells; Charging time: 24 hours.
- Lamp: T5 8 W.
- Accessories: 2 antivandalism polycarbonate clamps and PG-11 polyamide cable gland.

FR

LBloc autonome d'éclairage de sécurité, avec la possibilité de mise en repos à distance (télécommande). Installation en surface. Son degré d'étanchéité IP67 offre protection totale face à la poussière et face à la pénétration de liquides pendant des immersions de courte durée de temps.

Cette étanche est conçue pour les applications industrielles, agricoles, lieux publics, tunnels et les zones de sortie de secours des infrastructures publiques.

Grâce à son design cylindrique ses applications sont plus amples, pouvant être installé dans des installations commerciales, parkings et dans des lieux monumentaux.

Caractéristiques générales

- Corps du luminaire: Polycarbonate bicolor de 1 mm de épaisseur.
- Embouts: A.B.S.
- Réflecteur: Aluminium brillant.
- Colliers: Polycarbonate.
- Température d'utilisation: De -0° C a +55° C.
- Essai du fil incandescent: 850° C.
- Batterie: 3,6 V; 1500 mAh; 3 cellule de Ni/Cd; Temps de charge: 24 heures.
- Lampe: T5 8W.
- Accessoires: 2 colliers en polycarbonate antivandalisme et presse-étoupe 66 PG-11.



Ficha técnica
Technical data
Fiche technique

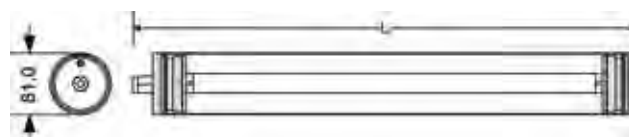

Las luminarias de policarbonato no soportan hidrocarburos

Polycarbonate light fittings don't allow hydrocarbons

Les luminaires de polycarbonate ne supportent pas les hydrocarbures

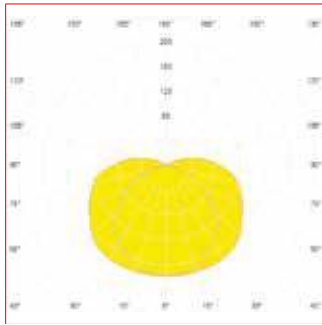

Ref.	Rendimiento Output Rendement	Equipo Equipment Ballast	Autonomia Autonomy Autonomie	Raee EU Recyclable tax Ecotaxe	Precio Price Prix
Q0301	100 lm	●	1,5 h.	0,50 €	91,68 €
Q0302	100 lm	●	1,5 h.	0,50 €	80,17 €

- Alto factor / High factor / Compensé
- Electrónica / Electronic / Électronique

ACCESORIOS EMELUX / EMELUX ACCESSORIES / ACCESSOIRES EMELUX

REF. Q0334

9,26 €



Brida de A.B.S. (2 unidades)
A.B.S. clamp (2 units)
Colliers en A.B.S. (2 uts.)

REF. Q0338

9,63 €



Bridas de acero cincado
(incremento de precio 2 uds.)
Zinc-plated steel clamps
(price increase 2 units.)
Colliers en acier galvanisé
(plus value de prix 2 uts.)

REF. Q0348

7,25 €



Bridas de acero inoxidable de apertura rápida
(incremento de precio 2 uds.)
Quick opening stainless steel clamps (price increase 2 units.)
Colliers inox de ouverture rapide à grenouillère (plus value de prix 2 uts.)

REF. Q0347

18,21 €



Bridas de acero inoxidable
(incremento de precio 2 uds.)
Stainless steel clamps
(price increase 2 units.)
Colliers inox antivandalisme
(plus value de prix 2 uts.)

REF. Q0349

12,21 €



Suspensión con cable de acero
Steel cable suspension
Suspension avec câble en acier

REF. Q0339

37,41 €



Tapas metálicas y racor metálico
(incremento de precio 2 uds.)
Metallic end caps and nickel-plated gland
(price increase 2 units.)
Embouts et presse-étoupe métallique (plus value de prix 2 uts.)

2.3

Luminarias estancas Waterproof luminaires Luminaires étanches



ES

Esta luminaria posee un índice de protección IP65, lo que la hace apropiada para ser instalada en locales húmedos y en exterior. Además, esta luminaria tiene el marcado F que posibilita el montaje sobre superficies normalmente inflamables.

Características generales

- Cuerpo luminaria: A.B.S.
- Reflector: Chapa de acero lacada en blanco.
- Difusor: Acrílico o Policarbonato.
- Corriente: 0.09-0.6 A.
- Tensión alimentación: 230V, 50Hz (electromagnética). 220-240V, 50-60Hz (electrónica). Para otras tensiones, consultar.
- Tipo de lampara: T8.
- Aislamiento eléctrico: Clase I / Clase II (bajo demanda).
- Temperatura de trabajo: De -20°C a +50°C.
- Según norma: EN 60598-1.
- Accesorios incluidos: Pasacables estanco. 2 pletinas metálicas de sujeción a techo. Elementos de fijación varios (tornillos, tacos).
- Sujeciones: Grapas de cierre de policarbonato irrompible.

EN

This light fitting has an IP65 protection rating making it suitable for installation in damp premises and outdoors. In addition, this is a grade F light fitting so it can be mounted on normally flammable surfaces.

General characteristics

- Light fitting body: High temperature ABS.
- Reflector: White lacquered steel plate.
- Diffuser: Acrylic or Polycarbonate.
- Current: 0.09-0.6 A.
- Power source: 230V, 50Hz (electromagnetic). 220-240V, 50-60Hz (electronic). Please contact us for other voltages.
- Lamp type: T8.
- Electrical insulation: Class I / Class II (upon request).
- Working temperature: From -20°C to +50°C (Depending on power).
- According to standard: EN 60598-1.
- Accessories included: Sealed gromets. Steel ceiling fixing elements. Unbreakable polycarbonate closing clips.
- Fasteners: Optional stainless steel clips.

FR

L'indice de protection IP65 de ce luminaire le rend apte à une installation dans des locaux humides ainsi qu'à l'extérieur. Ce luminaire marqué F est apte au montage sur des surfaces inflammables.

Caractéristiques générales

- Corps du luminaire: ABS haute température.
- Réflecteur: Tôle d'acier laquée en blanc.
- Diffuseur: Acrylique ou polycarbonate.
- Courant: 0.09-0.6 A.
- Tension d'alimentation: 230 V, 50 Hz (électromagnétique). 220-240 V, 50-60 Hz (électronique). Pour toute autre tension, s'adresser à Airfal.
- Type de lampe: T8.
- Isolation électrique: Classe I / Classe II (sur demande).
- Température d'utilisation: -20°C à +50°C.
- Selon norme: EN 60598-1.
- Accessoires fournis: Passe-câble étanche. Pattes de fixation au plafond en acier. Clips de fermeture en polycarbonate incassable.
- Éléments de fermeture: Clips acier inox en option.



Ficha técnica
Technical data
Fiche technique

Potencia Watts Puissance	B	C	D	Cierres Fasteners Fermetures
1 x 18 W	260	100	110	6
1 x 36 W	870	100	110	8
1 x 58 W	650	100	110	12
2 x 18 W	260	160	110	6
2 x 36 W	650	160	110	8
2 x 58 W	650	160	110	12

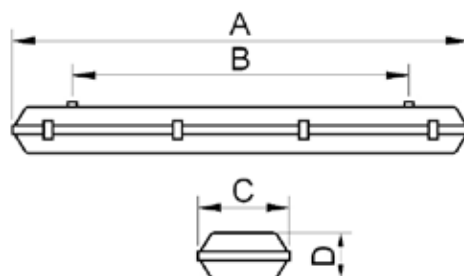

1 TUBO FLUORESCENTE / 1 LAMP / 1 LAMPE

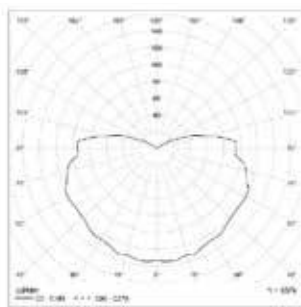

Ref. Acrylic Acrylique	Ref. PC	Potencia Watts Puissance	Equipo Equipment Ballast	Largo Length Longueur	Raee E. Recyclable tax Ecotaxe	Precio Price Prix Acrylic	Precio Price Prix PC
S0104	S1104	18 W	●	664	0,50 €	21,27 €	22,27 €
S0107	S1107	18 W	●	664	0,50 €	36,71 €	37,71 €
S0127	S1127	18 W	●	664	0,50 €	76,71 €	77,71 €
S0105	S1105	36 W	●	1.274	0,50 €	29,45 €	31,45 €
S0108	S1108	36 W	●	1.274	0,50 €	45,55 €	47,55 €
S0128	S1128	36 W	●	1.274	0,50 €	85,55 €	87,55 €
S0106	S1106	58 W	●	1.575	0,50 €	35,32 €	38,32 €
S0109	S1109	58 W	●	1.575	0,50 €	51,15 €	54,15 €
S0129	S1129	58 W	●	1.575	0,50 €	91,15 €	94,15 €

- Alto factor / High factor / Compensé
- Electrónica / Electronic / Électronique
- Regulable / Dimmable / Gradable

2 TUBOS FLUORESCENTES / 2 LAMPS / 2 LAMPES

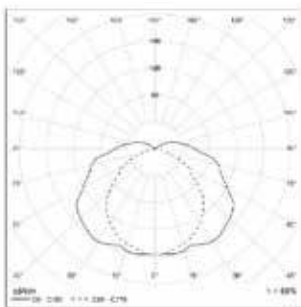

Ref. Acrylic Acrylique	Ref. PC	Potencia Watts Puissance	Equipo Equipment Ballast	Largo Length Longueur	Raee E. Recyclable tax Ecotaxe	Precio Price Prix Acrylic	Precio Price Prix PC
S0116	S1116	18 W	●	664	0,50 €	23,27 €	25,27 €
S0119	S1119	18 W	●	664	0,50 €	44,40 €	46,40 €
S0130	S1130	18 W	●	664	0,50 €	84,40 €	86,40 €
S0117	S1117	36 W	●	1.274	0,50 €	42,23 €	46,23 €
S0120	S1120	36 W	●	1.274	0,50 €	57,68 €	61,68 €
S0131	S1131	36 W	●	1.274	0,50 €	97,68 €	101,68 €
S0118	S1118	58 W	●	1.575	0,50 €	66,05 €	72,05 €
S0121	S1121	58 W	●	1.575	0,50 €	65,40 €	71,40 €
S0132	S1132	58 W	●	1.575	0,50 €	105,40 €	112,40 €

- Alto factor / High factor / Compensé
- Electrónica / Electronic / Électronique
- Regulable / Dimmable / Gradable

REFLECTOR ALUMINIO BRILLANTE GLOSSY ALUMINIUM REFLECTOR RÉFLECTEUR ALUMINIUM BRILLANT

Ref luminaria + "A". Ej.: S0132A
Light fitting ref + "A". Ex.: S0132A
Ref luminaire + "A". Ex.: S0132A

Potencia Watts Puissance	Aumento precio Price increase Plus value
1 x 18 W	3,55 €
1 x 36 W	5,40 €
1 x 58 W	6,35 €
2 x 18 W	4,85 €
2 x 36 W	8,00 €
2 x 58 W	9,55 €

2.3

Luminarias estancas Waterproof luminaires Luminaires étanches



ES

Esta luminaria posee un índice de protección IP65, lo que la hace apropiada para ser instalada en locales húmedos y en exterior. Además, esta luminaria tiene el marcado F que posibilita el montaje sobre superficies normalmente inflamables.

Características generales

- Cuerpo luminaria: A.B.S.
- Reflector: Chapa de acero lacada en blanco.
- Difusor: Acrílico o Policarbonato.
- Corriente: 0.09-0.6 A.
- Tensión alimentación: 230V, 50Hz (electromagnética). 220-240V, 50-60Hz (electrónica). Para otras tensiones, consultar.
- Tipo de lampara: T5.
- Aislamiento eléctrico: Clase I / Clase II (bajo demanda).
- Temperatura de trabajo: De -20°C a +50°C.
- Según norma: EN 60598-1.
- Accesorios incluidos: Pasacables estanco. 2 pletinas metálicas de sujeción a techo. Elementos de fijación varios (tornillos, tacos).
- Sujeciones: Grapas de cierre de policarbonato irrompible.

EN

This light fitting has an IP65 protection rating making it suitable for installation in damp premises and outdoors. In addition, this is a grade F light fitting so it can be mounted on normally flammable surfaces.

General characteristics

- Light fitting body: High temperature ABS.
- Reflector: White lacquered steel plate.
- Diffuser: Acrylic or Polycarbonate.
- Current: 0.09-0.6 A.
- Power source: 230V, 50Hz (electromagnetic). 220-240V, 50-60Hz (electronic). Please contact us for other voltages.
- Lamp type: T5.
- Electrical insulation: Class I / Class II (upon request).
- Working temperature: From -20°C to +50°C (Depending on power).
- According to standard: EN 60598-1.
- Accessories included: Sealed grommets. Steel ceiling fixing elements. Unbreakable polycarbonate closing clips.
- Fasteners: Optional stainless steel clips.

FR

L'indice de protection IP65 de ce luminaire le rend apte à une installation dans des locaux humides ainsi qu'à l'extérieur. Ce luminaire marqué F est apte au montage sur des surfaces inflammables.

Caractéristiques générales

- Corps du luminaire: ABS haute température.
- Réflecteur: Tôle d'acier laquée en blanc.
- Diffuseur: Acrylique ou polycarbonate.
- Courant: 0.09-0.6 A.
- Tension d'alimentation: 230 V, 50 Hz (électromagnétique). 220-240 V, 50-60 Hz (électronique). Pour toute autre tension, s'adresser à Airfal.
- Type de lampe: T5.
- Isolation électrique: Classe I / Classe II (sur demande).
- Température d'utilisation: -20°C à +50°C.
- Selon norme: EN 60598-1.
- Accessoires fournis: Passe-câble étanche. Pattes de fixation au plafond en acier. Clips de fermeture en polycarbonate incassable.
- Éléments de fermeture: Clips acier inox en option.



Ficha técnica
Technical data
Fiche technique

Potencia Watts Puissance	B	C	D	Cierres Fasteners Fermetures
1 x 14/24 W	260	100	110	6
1 x 28/54 W	870	100	110	8
1 x 35/49/80 W	650	100	110	12
2 x 14/24 W	260	100	110	6
2 x 28/54 W	870	100	110	8
2 x 35/49 W	650	100	110	12

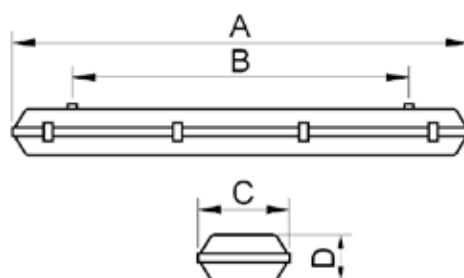

1 TUBO FLUORESCENTE / 1 LAMP / 1 LAMPE

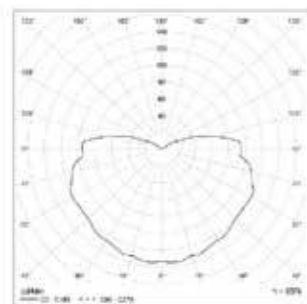

- Electrónica / **Electronic** / Électronique
- Regulable / **Dimmable** / Gradable

Ref. Acrílico Acrylic Acrylique	Ref. PC	Potencia Watts Puissance	Equipo Equipment Ballast	Largo Length Longueur	Raee E. Recyclable tax Ecotaxe	Precio Price Prix Acrílico	Precio Price Prix PC
Alta Eficacia / High Efficiency / Haute Efficacité							
S2001	S2101	14 W	●	664	0,50 €	30,62 €	31,62 €
S2014	S2114	14 W	●	664	0,50 €	70,62 €	71,61 €
S2002	S2102	28 W	●	1.274	0,50 €	46,01 €	48,01 €
S2015	S2115	28 W	●	1.274	0,50 €	86,01 €	88,01 €
S2003	S2103	35 W	●	1.575	0,50 €	53,32 €	56,32 €
S2016	S2116	35 W	●	1.575	0,50 €	93,32 €	96,32 €
Alto Rendimiento / High Output / Flux Élevé							
S2004	S2104	24 W	●	664	0,50 €	30,62 €	31,62 €
S2017	S2117	24 W	●	664	0,50 €	70,62 €	71,62 €
S2005	S2105	49 W	●	1.575	0,50 €	53,32 €	55,32 €
S2018	S2118	49 W	●	1.575	0,50 €	93,32 €	95,32 €
S2006	S2106	54 W	●	1.274	0,50 €	46,01 €	48,01 €
S2019	S2119	54 W	●	1.274	0,50 €	86,01 €	88,01 €
S2007	S2107	80 W	●	1.575	0,50 €	56,73 €	60,73 €
S2020	S2120	80 W	●	1.575	0,50 €	96,73 €	100,73 €

2 TUBOS FLUORESCENTES / 2 LAMPS / 2 LAMPES

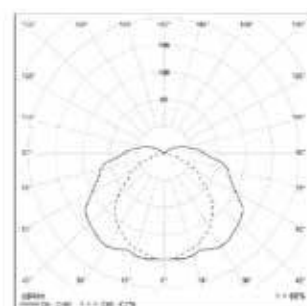

- Electrónica / **Electronic** / Électronique
- Regulable / **Dimmable** / Gradable

Ref. Acrílico Acrylic Acrylique	Ref. PC	Potencia Watts Puissance	Equipo Equipment Ballast	Largo Length Longueur	Raee E. Recyclable tax Ecotaxe	Precio Price Prix Acrílico	Precio Price Prix PC
Alta Eficacia / High Efficiency / Haute Efficacité							
S2008	S2108	14 W	●	664	0,50 €	46,86 €	48,86 €
S2021	S2121	14 W	●	664	0,50 €	86,86 €	88,86 €
S2009	S2109	28 W	●	1.274	0,50 €	56,19 €	60,19 €
S2022	S2122	28 W	●	1.274	0,50 €	96,19 €	100,19 €
S2010	S2110	35 W	●	1.575	0,50 €	65,22 €	71,22 €
S2023	S2123	35 W	●	1.575	0,50 €	105,22 €	111,22 €
Alto Rendimiento / High Output / Flux Élevé							
S2011	S2111	24 W	●	664	0,50 €	46,86 €	48,86 €
S2024	S2124	24 W	●	664	0,50 €	86,86 €	88,86 €
S2012	S2112	49 W	●	1.575	0,50 €	65,22 €	69,22 €
S2025	S2125	49 W	●	1.575	0,50 €	105,22 €	109,22 €
S2013	S2113	54 W	●	1.274	0,50 €	56,19 €	62,19 €
S2026	S2126	54 W	●	1.274	0,50 €	96,19 €	102,19 €

REFLECTOR ALUMINIO BRILLANTE GLOSSY ALUMINIUM REFLECTOR RÉFLECTEUR ALUMINIUM BRILLANT

Potencia Watts Puissance	Aumento precio Price increase Plus value
1 x 14/24 W	3,55 €
1 x 28/54 W	5,40 €
1 x 35/49/80 W	6,35 €
2 x 14/24 W	4,85 €
2 x 28/54 W	8,00 €
2 x 35/49 W	9,55 €

Ref luminaria + "A". Ej.: S2011A
Light fitting ref + "A". Ex.: S2011A
Ref luminaire + "A". Ex.: S2011A

2.3

Luminarias estancas Waterproof luminaires Luminaires étanches



ES

Esta luminaria posee un índice de protección IP65, lo que la hace apropiada para ser instalada en locales húmedos y en exterior. Además, esta luminaria tiene el marcado F que posibilita el montaje sobre superficies normalmente inflamables.

Características generales

- Cuerpo luminaria: A.B.S.
- Reflector: Chapa de acero lacada en blanco.
- Difusor: Acrílico o Policarbonato.
- Tipo de lámpara: T8
- Aislamiento eléctrico: Clase I / Clase II (bajo demanda).
- Según norma: EN 60598-1.
- Accesorios incluidos: Pasacables estanco. 2 pletinas metálicas de sujeción a techo. Cierres de policarbonato irrompible.
- Sujeciones: Opcional, cierres de acero inoxidable.

EN

This light fitting has an IP65 protection rating making it suitable for installation in damp premises and outdoors. In addition, this is a grade F light fitting so it can be mounted on normally flammable surfaces.

General characteristics

- Light fitting body: High temperature ABS.
- Reflector: White lacquered steel plate.
- Diffuser: Acrylic or Polycarbonate.
- Lamp type: T8.
- Electrical insulation: Class I / Class II (upon request).
- According to standard: EN 60598-1.
- Accessories included: Sealed grommets. Steel ceiling fixing elements. Unbreakable polycarbonate closing clips.
- Fasteners: Optional stainless steel clips.

FR

L'indice de protection IP65 de ce luminaire le rend apte à une installation dans des locaux humides ainsi qu'à l'extérieur. Ce luminaire marqué F est apte au montage sur des surfaces inflammables.

Caractéristiques générales

- Corps du luminaire: ABS haute température.
- Réflecteur: Tôle d'acier laquée en blanc.
- Diffuseur: Acrylique ou polycarbonate.
- Type de lampe: T8.
- Isolation électrique: Classe I / Classe II (sur demande).
- Selon norme: EN 60598-1.
- Accessoires fournis: Passe-câble étanche. Pattes de fixation au plafond en acier. Clips de fermeture en polycarbonate incassable.
- Éléments de fermeture: Clips acier inox en option.



Ficha técnica
Technical data
Fiche technique

	B	C	D	Cierres Fasteners Fermetures
1 x 600	260	100	110	6
1 x 1.200	870	100	110	8
1 x 1.500	650	100	110	12
2 x 600	260	160	110	6
2 x 1.200	650	160	110	8
2 x 1.500	650	160	110	12

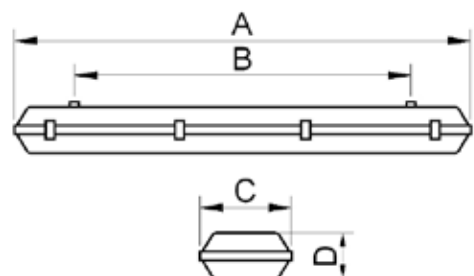

1 TUBO LED / 1 LED TUBE / 1 TUBE LED

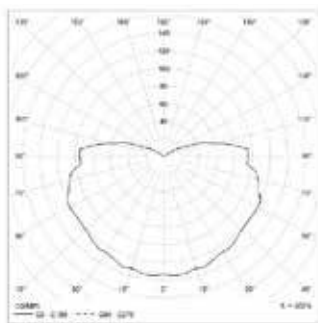

Ref. Acrílico Acrylic Acrylique	Ref. PC	Longitud tubo Tube length Longueur tube	Largo Length Longueur	Raee E. Recy- clable tax Ecotaxe	Precio Price Prix Acrílico	Precio Price Prix PC
S0107L	S1107L	600	664	0,50 €	24,71 €	25,71 €
S0108L	S1108L	1.200	1.274	0,50 €	33,55 €	35,55 €
S0109L	S1109L	1.500	1.575	0,50 €	39,15 €	42,15 €

2 TUBOS LED / 2 LED TUBES / 2 TUBES LED

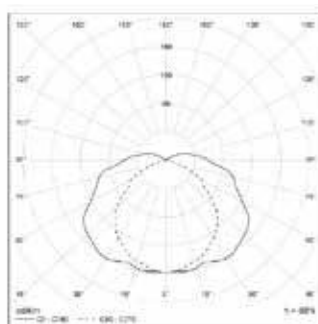

Ref. Acrílico Acrylic Acrylique	Ref. PC	Longitud tubo Tube length Longueur tube	Largo Length Longueur	Raee E. Recy- clable tax Ecotaxe	Precio Price Prix Acrílico	Precio Price Prix PC
S0119L	S1119L	600	664	0,50 €	32,40 €	34,40 €
S0120L	S1120L	1.200	1.274	0,50 €	45,68 €	49,68 €
S0121L	S1121L	1.500	1.575	0,50 €	53,40 €	59,40 €

ACCESORIOS SUPRA / SUPRA ACCESSORIES / ACCESSOIRES SUPRA

REF. S2150

0,70 €



Grapa de acero inoxidable
Stainless steel clip
Clip acier inox

REF. S2151

2,16 €



Sujeción a carril DELTA
Delta rail fastening
Platine de fixation sur rail DELTA

REF. SCLA2

23,80 €



CLASE II

Posibilidad de Clase II
Available for Class II
Possibilité de Classe II



2.3

Luminarias estancas Waterproof luminaires Luminaires étanches



ES

La regleta industrial estanca en IP65.

Características generales

- Cuerpo luminaria: Chapa de acero prelacada.
- Reflector (opcional): Aluminio brillante o chapa acero prelacada.
- Tapas finales: A.B.S.
- Temperatura de trabajo: De -20° C a +45° C.

EN

Waterproof industrial luminaire in IP65.

General characteristics

- Light fitting body: Lacquered steel.
- Reflector (optional): Glossy aluminium or lacquered steel.
- End caps: A.B.S.
- Working temperature: From -20° C to +45° C.

FR

Réglette industrielle étanche en IP65.

Caractéristiques générales

- Corps du luminaire: Acier laqué blanc.
- Réflecteur (optionnel): Aluminium brillant ou acier laqué blanc.
- Embouts: A.B.S.
- Température d'utilisation: De -20° C à +45° C.



Ficha técnica
Technical data
Fiche technique



DISPONIBLE PARA LED
CONSULTAR PRECIO

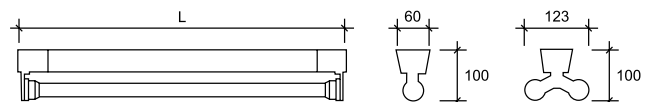

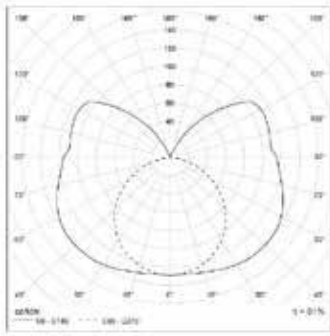

- Bajo factor / Low factor / Non-compensé
- Alto factor / High factor / Compensé
- Electrónica / Electronic / Electronique
- Regulable / Dimmable / Gradable

Ref.	Potencia Watts Puissance	Equipo Equipment Ballast	Largo Length Longueur	Raee EU Recyclable tax Ecotaxe	Precio Price Prix
M0102	18 W	●	624	0,50 €	30,11 €
M0108	18 W	●	624	0,50 €	32,25 €
M0125	18 W	●	624	0,50 €	44,74 €
M0141	18 W	●	624	0,50 €	84,74 €
M0105	36 W	●	1.233	0,50 €	34,32 €
M0111	36 W	●	1.233	0,50 €	36,45 €
M0126	36 W	●	1.233	0,50 €	49,36 €
M0142	36 W	●	1.233	0,50 €	89,36 €
M0106	58 W	●	1.534	0,50 €	39,62 €
M0112	58 W	●	1.534	0,50 €	42,39 €
M0127	58 W	●	1.534	0,50 €	51,00 €
M0143	58 W	●	1.534	0,50 €	91,00 €

2 TUBOS FLUORESCENTES / 2 LAMPS / 2 LAMPES

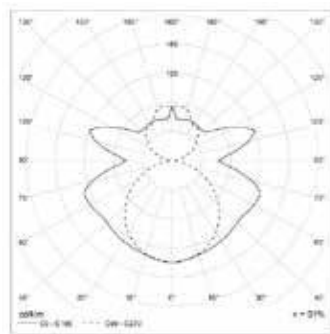

- Bajo factor / Low factor / Non-compensé
- Alto factor / High factor / Compensé
- Electrónica / Electronic / Electronique
- Regulable / Dimmable / Gradable

Ref.	Potencia Watts Puissance	Equipo Equipment Ballast	Largo Length Longueur	Raee EU Recyclable tax Ecotaxe	Precio Price Prix
M0114	18 W	●	624	0,50 €	39,82 €
M0120	18 W	●	624	0,50 €	41,95 €
M0128	18 W	●	624	0,50 €	52,95 €
M0144	18 W	●	624	0,50 €	92,95 €
M0117	36 W	●	1.233	0,50 €	52,22 €
M0123	36 W	●	1.233	0,50 €	55,21 €
M0129	36 W	●	1.233	0,50 €	57,18 €
M0145	36 W	●	1.233	0,50 €	97,18 €
M0118	58 W	●	1.534	0,50 €	61,22 €
M0124	58 W	●	1.534	0,50 €	65,58 €
M0130	58 W	●	1.534	0,50 €	59,04 €
M0146	58 W	●	1.534	0,50 €	99,04 €

2.3

Luminarias estancas Waterproof luminaires Luminaires étanches

1 TUBO FLUORESCENTE / 1 LAMP / 1 LAMPE

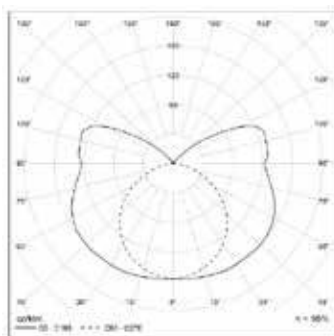
 G5
T5

Ref.	Potencia Watts Puissance	Equipo Equipment Ballast	Largo Length Longueur	Raee EU Recyclable tax Ecotaxe	Precio Price Prix
Alta Eficacia / High Efficiency / Haute Efficacité					
M0507	14 W	●	589	0,50 €	47,11 €
M0519	14 W	●	589	0,50 €	87,11 €
M0508	21 W	●	889	0,50 €	49,02 €
M0520	21 W	●	889	0,50 €	89,02 €
M0504	28 W	●	1.189	0,50 €	49,79 €
M0521	28 W	●	1.189	0,50 €	89,79 €
M0503	35 W	●	1.489	0,50 €	53,42 €
M0522	35 W	●	1.489	0,50 €	93,42 €
Alto Rendimiento / High Output / Flux Élevé					
M0505	24 W	●	589	0,50 €	47,11 €
M0523	24 W	●	589	0,50 €	87,11 €
M0509	39 W	●	889	0,50 €	49,02 €
M0524	39 W	●	889	0,50 €	89,02 €
M0510	49 W	●	1.489	0,50 €	53,42 €
M0525	49 W	●	1.489	0,50 €	93,42 €
M0502	54 W	●	1.189	0,50 €	49,79 €
M0526	54 W	●	1.189	0,50 €	89,79 €
M0501	80 W	●	1.489	0,50 €	61,29 €

- Electrónica / Electronic / Électronique
- Regulable / Dimmable / Gradable

2 TUBOS FLUORESCENTES / 2 LAMPS / 2 LAMPES

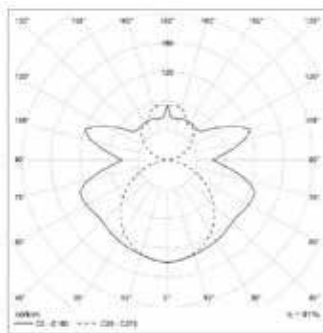

Ref.	Potencia Watts Puissance	Equipo Equipment Ballast	Largo Length Longueur	Raee EU Recyclable tax Ecotaxe	Precio Price Prix
Alta Eficacia / High Efficiency / Haute Efficacité					
M0511	14 W	●	589	0,50 €	63,88 €
M0528	14 W	●	589	0,50 €	103,88 €
M0512	21 W	●	889	0,50 €	65,55 €
M0529	21 W	●	889	0,50 €	105,55 €
M0513	28 W	●	1.189	0,50 €	67,48 €
M0530	28 W	●	1.189	0,50 €	107,48 €
M0506	35 W	●	1.489	0,50 €	70,29 €
M0531	35 W	●	1.489	0,50 €	110,29 €
Alto Rendimiento / High Output / Flux Élevé					
M0514	24 W	●	589	0,50 €	63,88 €
M0532	24 W	●	589	0,50 €	103,88 €
M0515	39 W	●	889	0,50 €	65,55 €
M0533	39 W	●	889	0,50 €	105,55 €
M0516	49 W	●	1.489	0,50 €	70,29 €
M0534	49 W	●	1.489	0,50 €	110,29 €
M0517	54 W	●	1.189	0,50 €	67,48 €
M0535	54 W	●	1.189	0,50 €	107,48 €

- Electrónica / Electronic / Électronique
- Regulable / Dimmable / Gradable

2.3

Luminarias estancas

Waterproof luminaires

Luminaires étanches

REFLECTOR SIMÉTRICO

SYMMETRICAL REFLECTOR

RÉFLECTEUR SYMÉTRIQUE

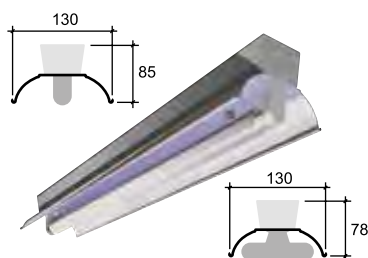

Potencia Watts Puissance	Chapa precalada Lacquered steel Acier laqué		Aluminio brillante Glossy aluminium Aluminium brillant	
	Ref.	Precio Price Prix	Ref.	Precio Price Prix
1 / 2 x 18 W	MA100	5,57 €	MA1A0	5,71 €
1 / 2 x 36 W	MA200	7,83 €	MA2A0	11,13 €
1 / 2 x 58 W	MA300	9,20 €	MA3A0	14,05 €
1 / 2 x 14/24 W	ME100	5,87 €	ME1A0	9,36 €
1 / 2 x 21/39 W	ME200	9,01 €	ME2A0	14,48 €
1 / 2 x 28/54 W	ME300	12,34 €	ME3A0	16,95 €
1 / 2 x 35/49W	ME400	15,42 €	ME4A0	23,64 €

REFLECTOR ASIMÉTRICO E

ASYMMETRICAL E REFLECTOR

RÉFLECTEUR ASYMÉTRIQUE E

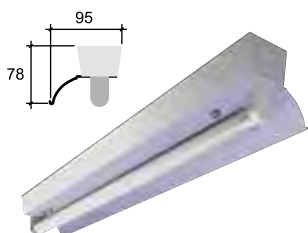

Potencia Watts Puissance	Chapa precalada Lacquered steel Acier laqué		Aluminio brillante Glossy aluminium Aluminium brillant	
	Ref.	Precio Price Prix	Ref.	Precio Price Prix
1 x 18 W	MC100	5,35 €	MC1A0	7,18 €
1 x 36 W	MC200	9,30 €	MC2A0	12,60 €
1 x 58 W	MC300	10,67 €	MC3A0	15,52 €
1 x 14/24 W	MG100	8,45 €	MG1A0	11,93 €
1 x 21/39 W	MG200	11,66 €	MG2A0	17,06 €
1 x 28/54 W	MG300	14,91 €	MG3A0	19,53 €
1 x 35/49W	MG400	18,00 €	MG4A0	26,21 €

REFLECTOR ASIMÉTRICO i

ASYMMETRICAL i REFLECTOR

RÉFLECTEUR ASYMÉTRIQUE i

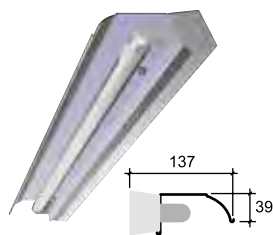

Potencia Watts Puissance	Chapa precalada Lacquered steel Acier laqué		Aluminio brillante Glossy aluminium Aluminium brillant	
	Ref.	Precio Price Prix	Ref.	Precio Price Prix
1 x 18 W	MD100	11,23 €	MD1A0	13,06 €
1 x 36 W	MD200	15,18 €	MD2A0	18,49 €
1 x 58 W	MD300	16,56 €	MD3A0	21,41 €
1 x 14/24 W	MH100	18,75 €	MH1A0	22,23 €
1 x 21/39 W	MH200	21,96 €	MH2A0	27,36 €
1 x 28/54 W	MH300	25,21 €	MH3A0	29,83 €
1 x 35/49W	MH400	28,30 €	MH4A0	36,51 €

2.4

Luminarias estancas Waterproof luminaires Luminaires étanches



ES

La regleta industrial semiestanca en IP42.

Características generales

- Cuerpo luminaria: Chapa de acero prelacada.
- Reflector (opcional): Aluminio brillante o chapa acero prelacada.
- Tapas finales: A.B.S.
- Temperatura de trabajo: De -20° C a +45° C.

EN

Semi-waterproof industrial luminaire in IP42.

General characteristics

- Light fitting body: Lacquered steel.
- Reflector (optional): Glossy aluminium or lacquered steel.
- End caps: A.B.S.
- Working temperature: From -20° C to +45° C.

FR

Réglette industrielle demi-étanche en IP42.

Caractéristiques générales

- Corps du luminaire: Acier laqué blanc.
- Réflecteur (optionnel): Aluminium brillant ou acier laqué blanc.
- Embouts: A.B.S.
- Température d'utilisation: De -20° C à +45° C.



Ficha técnica
Technical data
Fiche technique



DISPONIBLE PARA LED
CONSULTAR PRECIO

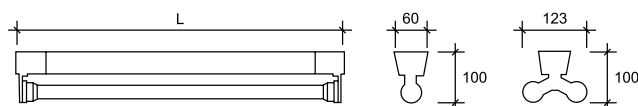

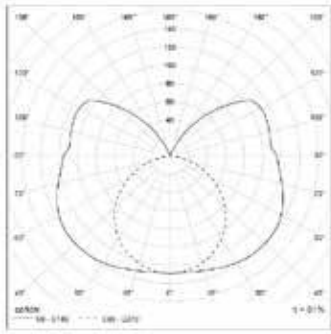

- Bajo factor / Low factor / Non-compensé
- Alto factor / High factor / Compensé
- Electrónica / Electronic / Électronique
- Regulable / Dimmable / Gradable

Ref.	Potencia Watts Puissance	Equipo Equipment Ballast	Largo Length Longueur	Raee EU Recyclable tax Ecotaxe	Precio Price Prix
M0002	18 W	●	624	0,50 €	25,13 €
M0008	18 W	●	624	0,50 €	27,32 €
M0025	18 W	●	624	0,50 €	40,14 €
M0041	18 W	●	624	0,50 €	80,14 €
M0005	36 W	●	1.233	0,50 €	27,76 €
M0011	36 W	●	1.233	0,50 €	29,95 €
M0026	36 W	●	1.233	0,50 €	41,22 €
M0042	36 W	●	1.233	0,50 €	81,22 €
M0006	58 W	●	1.534	0,50 €	32,05 €
M0012	58 W	●	1.534	0,50 €	34,88 €
M0027	58 W	●	1.534	0,50 €	42,13 €
M0043	58 W	●	1.534	0,50 €	82,13 €

2 TUBOS FLUORESCENTES / 2 LAMPS / 2 LAMPES

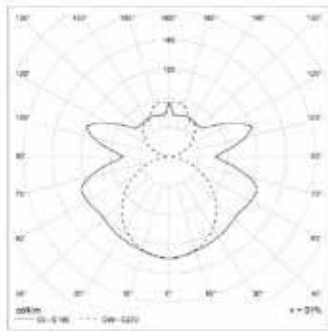

- Bajo factor / Low factor / Non-compensé
- Alto factor / High factor / Compensé
- Electrónica / Electronic / Électronique
- Regulable / Dimmable / Gradable

Ref.	Potencia Watts Puissance	Equipo Equipment Ballast	Largo Length Longueur	Raee EU Recyclable tax Ecotaxe	Precio Price Prix
M0014	18 W	●	624	0,50 €	33,77 €
M0020	18 W	●	624	0,50 €	35,91 €
M0028	18 W	●	624	0,50 €	46,96 €
M0044	18 W	●	624	0,50 €	86,96 €
M0017	36 W	●	1.233	0,50 €	44,80 €
M0023	36 W	●	1.233	0,50 €	47,78 €
M0029	36 W	●	1.233	0,50 €	49,77 €
M0045	36 W	●	1.233	0,50 €	89,77 €
M0018	58 W	●	1.534	0,50 €	52,85 €
M0024	58 W	●	1.534	0,50 €	57,22 €
M0030	58 W	●	1.534	0,50 €	50,59 €
M0046	58 W	●	1.534	0,50 €	90,59 €

2.4

Luminarias estancas Waterproof luminaires Luminaires étanches

1 TUBO FLUORESCENTE / 1 LAMP / 1 LAMPE

G5
T5

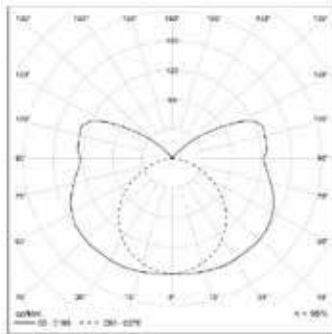

Ref.	Potencia Watts Puissance	Equipo Equipment Ballast	Largo Length Longueur	Raee EU Recyclable tax Ecotaxe	Precio Price Prix
Alta Eficacia / High Efficiency / Haute Efficacité					
M0604	14 W	●	589	0,50 €	42,21 €
M0619	14 W	●	589	0,50 €	82,21 €
M0605	21 W	●	889	0,50 €	43,48 €
M0620	21 W	●	889	0,50 €	83,48 €
M0603	28 W	●	1.189	0,50 €	44,27 €
M0621	28 W	●	1.189	0,50 €	84,27 €
M0602	35 W	●	1.489	0,50 €	45,10 €
M0622	35 W	●	1.489	0,50 €	85,10 €
Alto Rendimiento / High Output / Flux Élevé					
M0606	24 W	●	589	0,50 €	42,21 €
M0623	24 W	●	589	0,50 €	82,21 €
M0607	39 W	●	889	0,50 €	43,48 €
M0624	39 W	●	889	0,50 €	83,48 €
M0601	49 W	●	1.489	0,50 €	45,10 €
M0625	49 W	●	1.489	0,50 €	85,10 €
M0608	54 W	●	1.189	0,50 €	44,27 €
M0626	54 W	●	1.189	0,50 €	84,27 €
M0609	80 W	●	1.489	0,50 €	54,34 €
M0627	80 W	●	1.489	0,50 €	94,34 €

- Electrónica / Electronic / Électronique
- Regulable / Dimmable / Gradable

2 TUBOS FLUORESCENTES / 2 LAMPS / 2 LAMPES

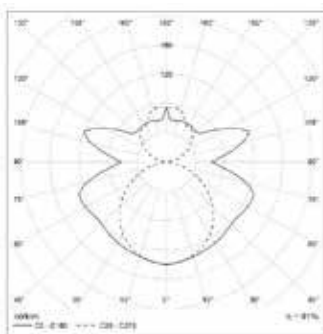

Ref.	Potencia Watts Puissance	Equipo Equipment Ballast	Largo Length Longueur	Raee EU Recyclable tax Ecotaxe	Precio Price Prix
Alta Eficacia / High Efficiency / Haute Efficacité					
M0610	14 W	●	589	0,50 €	59,24 €
M0628	14 W	●	589	0,50 €	99,24 €
M0611	21 W	●	889	0,50 €	61,26 €
M0629	21 W	●	889	0,50 €	101,26 €
M0612	28 W	●	1.189	0,50 €	61,71 €
M0630	28 W	●	1.189	0,50 €	101,71 €
M0613	35 W	●	1.489	0,50 €	62,25 €
M0631	35 W	●	1.489	0,50 €	102,25 €
Alto Rendimiento / High Output / Flux Élevé					
M0614	24 W	●	589	0,50 €	59,24 €
M0632	24 W	●	589	0,50 €	99,24 €
M0615	39 W	●	889	0,50 €	61,26 €
M0633	39 W	●	889	0,50 €	101,26 €
M0616	49 W	●	1.489	0,50 €	62,25 €
M0634	49 W	●	1.489	0,50 €	102,25 €
M0617	54 W	●	1.189	0,50 €	61,71 €
M0635	54 W	●	1.189	0,50 €	101,71 €

- Electrónica / Electronic / Électronique
- Regulable / Dimmable / Gradable

ACCESORIOS MODELO M / MODEL M ACCESSORIES / ACCESSOIRES MODÈLE M

Carril Track Rail	Perfil Profile Profile	Carril / Track / Rail 3070 MMS. 2 X 58		Carril / Track / Rail 3070 MMS. 3 X 36		Tapa final End cap Embout		Empalme Track joint Pièce de liaison	
		Ref.	Precio Price Prix	Ref.	Precio Price Prix	Ref.	Precio Price Prix	Ref.	Precio Price Prix
CHAPA ACERO / LACQUERED STEEL / ACIER LAQUÉ 25 X 67,2 MMS.		M0059	18,50 €	M0060	22,09 €	M0034	0,73 €	M0064	2,75 €
ALUMINIO / ALUMINIUM / ALUMINIUM 22,5 X 64 MMS.		M0061	37,32 €	M0062	44,96 €	M0065	0,63 €	M0064	2,75 €
ALUMINIO / ALUMINIUM / ALUMINIUM 26,5 X 64 MMS.		M0084	44,08 €	M0085	53,14 €	M0081	0,39 €	M0064	2,75 €
ALUMINIO / ALUMINIUM / ALUMINIUM 41,5 X 64 MMS.		M0086	47,49 €	M0087	56,98 €	M0082	0,41 €	M0083	3,24 €

**Sujeción a carril
Fastener for track
Fixation au RAIL**

REF. M0063 0,64 €
IP42
REF. M0088 1,27 €
IP65

**Empalme de carril
Track joint
Pièce de liaison**

**Tapa final
End cap
Embout**

**Tapa ciega de aluminio
Track cap on aluminium
Couvercle en aluminium**

REF. M0066 9,64 €
**Metro lineal
Lineal meter
Mètre linéaire**

**Tapa ciega de A.B.S.
A.B.S. track cap
Couvercle en A.B.S.**

REF. M0070 4,04 €
**Metro lineal
Lineal meter
Mètre linéaire**

REF. M0191 5,32 €
**Fijación carril a perfil techo
desmontable
Track fastener to removable
ceiling profile
Fixation de carril au profil du
plafond démontable**

REF. M0032 3,99 €
**Adaptador aro estanco Ø50 mm
Watertight ring Ø50 mm
Bague porte-douille étanche Ø50 mm**

REF. M0031 2,24 €
**Adaptador aro estanco Ø38 mm
Watertight ring Ø38 mm
Bague porte-douille étanche Ø38 mm**

Tubo policarbonato / Polycarbonate tube / Tube de polycarbonate

	Ø26		Ø38		Ø50	
	Ref.	Precio Price Prix	Ref.	Precio Price Prix	Ref.	Precio Price Prix
18 W	TP018	2,15 €	SP020	3,64 €	M0207	5,87 €
36 W	TP036	4,07 €	SP040	6,87 €	M0210	12,23 €
58 W	TP058	5,07 €	SP065	8,45 €	M0211	15,36 €

Si se desea acoplar un tubo protector de diámetro superior al del tubo fluorescente, existen disponibles aros estancos adaptadores a 38 ó 50 mm de diámetro

If a protective tube is needed of a bigger diameter than the fluorescent tube, there are available waterproofing ring adaptors of 38 or 50 mm in diameter.

Si on veut utiliser un tube protecteur de diamètre supérieur à celui de la lampe, ils existent différentes bagues étanches de 38 ou 50 mm de diamètre.

2.5

Luminarias estancas
Waterproof luminaires
Luminaires étanches

	Estancas Waterproof Étanche
Accesos de pública concurrencia Crowded public access Accès publics à forte densité	TR4, EMELUX COMPACT, TR1, RESIST, RINOX
Aeropuertos / estaciones de tren, metro Airport / Railway station Aéroports / stations de train, métro	EMELUX, TR2, TR3 TR4, RESIST, TR1
Agroalimentario Food industry Industrie agroalimentaire	TR2, TR3, EMELUX TR1, CHEMICAL, RINOX
Aplicaciones navales Naval applications Applications nautiques	TR2, TR3, TR4, RINOX CHEMICAL, RESIST, TR1, EMELUX
Áreas de alta temperatura High temperature areas Zones à haute température	TR2, RINOX RESIST
Áreas de baja temperatura Low temperatures areas Zones à basse température	TR3
Aulas de enseñanza Classrooms Salles de classe	TR1, EMELUX
Comercios y escaparates Shops and shop windows Commerces et vitrines	TR4 TR1, COMPACT
Túneles Tunnels Tunnels	TR2, TR3, RINOX, EMELUX RESIST, TUNNEL
Fachadas Facades Façades	TR2, TR3, EMELUX COMPACT, TR4, RESIST, RINOX
Garages Garages Garages	TR3, TR4, TUNNEL, EMELUX, RESIST, CHEMICAL, SUPRA, TR1, RINOX
Gasolineras / Refinerías Gas stations / Refineries Stations service / Raffineries	TR2, TUNNEL CHEMICAL, SUPRA
Hospitales Hospitals Hôpital	CHEMICAL
Invernaderos Greenhouses Serres	CHEMICAL, TR3, RINOX RESIST, TR2, EMELUX
Naves industriales Warehouses Entrepôts industriels	CHEMICAL, TR3, RINOX RESIST, TR2, EMELUX, LUXLEX
Oficinas Offices Bureaux	TR1, EMELUX
Piscinas / SPA Swimming pools / SPA Piscines / SPA	TR4, MODELO M, EMELUX RESIST, COMPACT, RINOX
Puentes Bridges Ponts	TR3, TR4, EMELUX RESIST, COMPACT, RINOX
Supermercados Supermarkets Supermarchés	TR3, MODELO M, EMELUX TR1, SUPRA
Zonas deportivas Sport areas Terrains de sport	TR3, TR1, RINOX, RESIST TR4, TR2, EMELUX





TR3 personalizada / custom creation / creation sur mesure

Estación de metro de Benimamet, Valencia, España

[Benimamet underground station, Valencia, Spain](#)

Station de metro de Benimamet, Valencia, Espagne



TR3 personalizada / custom creation / creation sur mesure

Estación de metro de Benimamet, Valencia, España



Benimamet underground station, Valencia, Spain

Station de metro de Benimamet, Valencia, Espagne

ATEX

EX

ATEX

3.1	IP66	PYROS 	132
3.2	IP66	VITRA 	136
3.3	IP68	FLAME	140
3.4	IP68	SECURE 	142
3.5	IP65	MINEX	148
3.6	IP65	LUMEX	150
3.7	IP65	TAURUS	152
3.8		Mercado ATEX EX marking Marquage ATEX	154
3.9		Cuadro de aplicaciones Applications chart Tableau d'applications	156





3.1

Atex Ex Atex



Brida
Clamp
Collier

ES

Luminaria **ANTIDÉFLAGRANTE** fluorescente de envoltorio compuesta por un tubo de **policarbonato** y tapas en aluminio. Gran resistencia mecánica.

Equipo electrónico y portalámparas montados sobre reflector extraíble que facilita las tareas de mantenimiento.

Dispone de 2 entradas de cable (rosca M25) para ofrecer la posibilidad de instalación en línea continua.

Características generales

- Cuerpo luminaria: Tubo de policarbonato de 4 mm de espesor.
- Reflector: Chapa acero pintada en blanco.
- Tapas: Aluminio 2030 (pintura de poliéster RAL 7047).
- Marcado ATEX 94/9/CE: II 2GD Ex d IIB+H2 T6 Gb Ex tb IIIC T85°C Db.
- Equipo: Electrónico o regulación de flujo.
- Temperatura de trabajo: De -25° C a +55° C.
- Entrada de cables: Rosca M25 (2 entradas).
- Accesorios: 2 abrazaderas de acero zincado con protección de caucho y 2 cáncamos (incluidos).
- Ensayo hilo incandescente: 960 °C.

EN

EXPLOSION PROOF light fixture made of **policarbonate** cover and aluminum ends. Great mechanic strength. Electronic ballast and lamp holders mounted over removable reflector which make maintenance work easier.

It has two wire entries (M25 screw type) to offer the possibility of continuous line installation.

General characteristics

- Light fitting body: Polycarbonate tube of 4 mm thickness.
- Reflector: Lacquered steel painted white.
- End caps: Aluminium 2030 (polyester paint RAL 7047).
- Marked ATEX 94/9/CE: II 2GD Ex d IIB+H2 T6 Gb Ex tb IIIC T85°C Db.
- Equipment: Electronic or dimmable.
- Working temperature: From -25° C to +55° C.
- Wiring entry: M25 screw type (2 entries).
- Accessories: 2 zinc covered clamps, with rubber protection and 2 eyebolt holders (included).
- Glow wire test: 960 °C.

FR

Luminaire fluorescent d'enveloppe **ANTIDÉFLAGRANTE** composé d'un tube de **policarbonate** et embouts en aluminium. Équipe électronique et porte lampes montés sur un réflecteur extractible qui facilitent les travaux d'entretien.

Il dispose de deux entrées de câble (filet M25) pour offrir la possibilité de faire une installation en ligne continue.

Il dispose de deux entrées de câble (filet M25) pour offrir la possibilité de faire une installation en ligne continue.

Caractéristiques générales

- Corps du luminaire: Tube de polycarbonate de 4 mm d'épaisseur.
- Réflecteur: Acier blanc.
- Embouts: Aluminium 2030 (peinture de polyester RAL 7047).
- Marquage ATEX 94/9/CE: II 2GD Ex d IIB+H2 T6 Gb Ex tb IIIC T85°C Db.
- Ballast: Électronique ou gradable.
- Température d'utilisation: De -25° C à +55° C.
- Entrée de câbles: Fillet M25 (2 entrées).
- Accessoires: 2 colliers d'acier zincé avec protection en caoutchouc (inclus).
- Essai du fil incandescent: 960 °C.



Ficha técnica
Technical data
Fiche technique

Las abrazaderas pueden desplazarse a lo largo de cualquier punto del tubo de policarbonato, dando así flexibilidad para una instalación más sencilla.

The clamps can move freely throughout any point within the polycarbonate tube, giving it added flexibility for an easier installation.

Les colliers peuvent être déplacés sur toute la longueur du tube de polycarbonate, ce qui permet une installation plus simple.

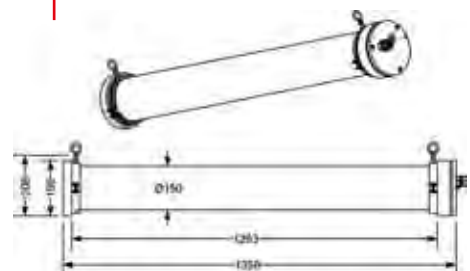

1 TUBO FLUORESCENTE / 1 LAMP / 1 LAMPE

G 13
T8

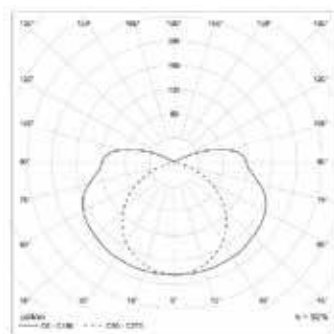

Ref.	Potencia Watts Puissance	Equipo Equipment Ballast	Peso Weight Poids	Largo Length Longueur	Raee EU Recyclable tax Ecotaxe	Precio Price Prix
EX005	18 W	●	9,7	748	0,70 €	670,03 €
EX007	18 W	●	9,7	748	0,70 €	710,03 €
EX001	36 W	●	11,5	1.357	0,70 €	737,07 €
EX003	36 W	●	11,5	1.357	0,70 €	777,07 €
EX009	58 W	●	12,3	1.659	0,70 €	781,22 €
EX011	58 W	●	12,3	1.659	0,70 €	821,22 €

● Electrónica / *Electronic* / *Électronique*

● Regulable / *Dimmable* / *Gradable*

2 TUBOS FLUORESCENTES / 2 LAMPS / 2 LAMPES

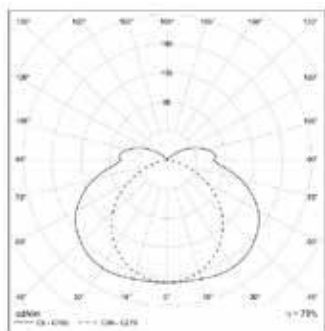

Ref.	Potencia Watts Puissance	Equipo Equipment Ballast	Peso Weight Poids	Largo Length Longueur	Raee EU Recyclable tax Ecotaxe	Precio Price Prix
EX006	18 W	●	9,7	748	0,70 €	679,52 €
EX008	18 W	●	9,7	748	0,70 €	719,52 €
EX002	36 W	●	11,5	1.357	0,70 €	747,86 €
EX004	36 W	●	11,5	1.357	0,70 €	787,86 €
EX010	58 W	●	12,3	1.659	0,70 €	793,36 €
EX012	58 W	●	12,3	1.659	0,70 €	833,36 €

● Electrónica / *Electronic* / *Électronique*

● Regulable / *Dimmable* / *Gradable*

Kit de emergencia 4,8 V - 4,0 Ah
Emergency kit 4,8 V - 4,0 Ah
Éclairage de secours 4,8 V - 4,0 Ah
 REF. 0EM05 150,45 €

3.1

Atex Ex Atex



Brida
Clamp
Collier

ES

Características generales

- Marcado ATEX 94/9/CE: II 2GD Ex d IIB+H2 T6 Gb Ex tb IIIC T85°C Db.
- Temperatura de trabajo: Consultar al fabricante del tubo LED
- Entrada de cables: Rosca M25 (2 entradas).
- Accesorios: 2 abrazaderas de acero zincado con protección de caucho y 2 cáncamos (incluidos).
- Ensayo hilo incandescente: 960 °C.

CONSULTAR TUBOS HOMOLOGADOS PARA ESTA LUMINARIA.

EN

General characteristics

- Marked ATEX 94/9/CE: II 2GD Ex d IIB+H2 T6 Gb Ex tb IIIC T85°C Db.
- Working temperature: Ask the LED manufacturer.
- Wiring entry: M25 screw type (2 entries).
- Accessories: 2 zinc covered clamps, with rubber protection and 2 eyebolt holders (included).
- Glow wire test: 960 °C.

REQUEST APPROVED LED TUBES FOR THIS LIGHT FITTING.

FR

Caractéristiques générales

- Marquage ATEX 94/9/CE: II 2GD Ex d IIB+H2 T6 Gb Ex tb IIIC T85°C Db.
- Température d'utilisation: Consultez au fabricant du tube LED
- Entrée de câbles: Filet M25 (2 entrées).
- Accessoires: 2 colliers d'acier zincé avec protection en caoutchouc (inclus).
- Essai du fil incandescent: 960° C.

CONSULTEZ NOUS LES TUBES LED HOMOLOGUÉS POUR CE LUMINAIRE.

1 TUBO LED / 1 LED TUBE / 1 TUBE LED

G 13
T8

Ref.	Longitud Tubo Tube Length Longueur Tube	Longitud Luminaria Fitting Length Longueur Luminaire	Peso Weight Poids	Rae EU Recyclable tax Ecotaxe	Precio Price Prix
EX005L	600 mms.	748 mms.	9,7	0,70 €	658,25 €
EX001L	1.200 mms.	1.357 mms.	11,5	0,70 €	725,07 €
EX009L	1.500 mms.	1.659 mms.	12,3	0,70 €	769,22 €

2 TUBOS LED / 2 LED TUBES / 2 TUBES LED

Ref.	Longitud Tubo Tube Length Longueur Tube	Longitud Luminaria Fitting Length Longueur Luminaire	Peso Weight Poids	Rae EU Recyclable tax Ecotaxe	Precio Price Prix
EX006L	600 mms.	748 mms.	9,7	0,70 €	667,52 €
EX002L	1.200 mms.	1.357 mms.	11,5	0,70 €	735,86 €
EX010L	1.500 mms.	1.659 mms.	12,3	0,70 €	781,36 €



Ficha técnica
Technical data
Fiche technique



Tapón EEx d
Plug EEx d
Bouchon EEx d

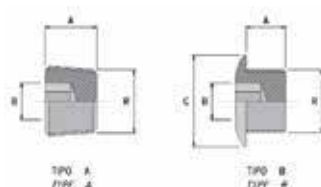

II 2 GD EEx d IIC T6

Ref.	Tamaño de rosca (R) Thread size Taille du filet (R)			Dimensiones Dimensions Dimensions			Precio Price Prix
	Métrica / Metrics / Métrique			A	B	C	
	EX501	M-25			15	10	30



Prensaestopa EEx d
Cablegland EEx d
Presse-étoupe EEx d

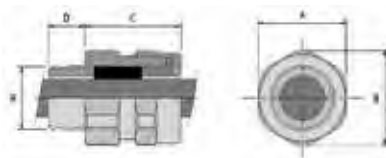

II 2 GD EEx d IIC T6

Ref.	Tamaño de rosca (R) Thread size Taille du filet (R)						Dimensiones Dimensions Dimensions				Ø Exterior Ø Overall Ø Extérieur			Precio Price Prix
	Métrica Metrics Métrique	PG.		NPT		Gas cónica Gas conic Gaz conique	A	B	C	D	Min.	Max.	Tipo Type Tipo	
EX502	M-25 x 1,5	16	21	3/4"	1"	3/4" 1"	35	39	42	15	7	10	A	44,31 €
EX503	M-25 x 1,5	16	21	3/4"	1"	3/4" 1"	35	39	42	15	9	12	B	45,79 €
EX504	M-25 x 1,5	16	21	3/4"	1"	3/4" 1"	35	39	42	15	11	14	C	39,24 €
EX505	M-25 x 1,5	16	21	3/4"	1"	3/4" 1"	35	39	42	15	13	16	D	39,24 €
EX506	M-25 x 1,5	16	21	3/4"	1"	3/4" 1"	35	39	42	15	15	18	E	39,24 €

Para cumplir con lo estipulado en la certificación ATEX de esta luminaria es obligatorio instalarlas con un tapon y un prensaestopas o, en caso de líneas continuas, con dos prensaestopas. Para cables sin armadura.

To comply with ATEX certification, is mandatory to install them with 1 end cap and 1 cablegland, or in case of continuous lines, with 2 cableglans. To be used with unarmored cables.

Pour être conforme à la certification ATEX de ce luminaire, Il est obligatoire d'utiliser un bouchon et un presse-étoupes, dans le cas d'une installation en ligne continue deux presses-étoupes. Pour cables non armés.

3.2

Atex Ex Atex

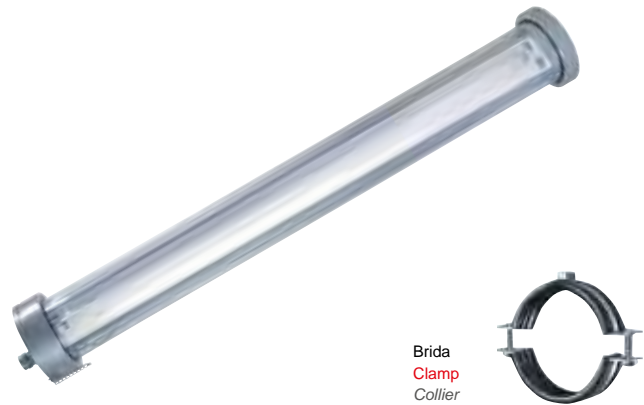

Brida
Clamp
Collier

ES

Luminaria **ANTIDÉFLAGRANTE** fluorescente de envoltorio compuesta por un tubo de **vidrio borosilicato templado** y tapas en aluminio. Gran resistencia calórica y química. Equipo electrónico y portalámparas montados sobre reflector extraíble que facilita las tareas de mantenimiento. Dispone de 2 entradas de cable (rosca M25) para ofrecer la posibilidad de instalación en línea continua.

Características generales

- Cuerpo luminaria: Tubo de vidrio borosilicato templado de 7 mm de espesor.
- Reflector: Chapa acero pintada en blanco.
- Tapas: Aluminio 2030 (pintura de poliéster RAL 7047).
- Marcado ATEX 94/9/CE: II 2GD Ex d IIC T6 Gb. Ex t IIIC T85° C Db.
- Equipo: Electrónico o regulación de flujo.
- Temperatura de trabajo: De -25° C a +55° C.
- Entrada de cables: Rosca M25 (2 entradas).
- Accesorios: 2 abrazaderas de acero zincado con protección de caucho y 2 cáncamos (incluidos).
- Ensayo hilo incandescente: No combustible.

EN

EXPLOSION PROOF light fixture made of **borosilicate tempered glass** cover and aluminum ends. Great heat and chemical strength. Electronic ballast and lamp holders mounted over removable reflector which makes maintenance work easier.

It has two wire entries (M25 screw type) to offer the possibility of continuous line installation.

General characteristics

- Light fitting body: Borosilicate tempered glass tube of 7 mm thickness.
- Reflector: Lacquered steel painted white.
- End caps: Aluminum 2030 (polyester paint RAL 7047).
- Marked ATEX 94/9/CE: II 2GD Ex d IIC T6 Gb. Ex t IIIC T85° C Db.
- Equipment: Electronic or dimmable.
- Working temperature: From -25° C to +55° C.
- Wiring entry: M25 screw type (2 entries).
- Accessories: 2 zinc covered clamps, with rubber protection and 2 eyebolt holders (included).
- Glow wire test: Non Com.

FR

Luminaire fluorescent d'enveloppe **ANTIDÉFLAGRANTE** composé d'un tube de **trempe verre borosilicate** et embouts en aluminium. Élevée résistance calorique et aux produits chimiques. Équipe électronique et porte lampes montés sur un réflecteur extractible qui facilitent les travaux d'entretien.

Il dispose de deux entrées de câble (filet M25) pour offrir la possibilité de faire une installation en ligne continue.

Caractéristiques générales

- Corps du luminaire: Tube de verre borosilicate trempé de 7 mm de épaisseur.
- Reflector: Acier blanc.
- Embouts: Aluminium 2030 (peinture de polyester RAL 7047).
- Marquage ATEX 94/9/CE: II 2GD Ex d IIC T6 Gb. Ex t IIIC T85° C Db.
- Ballast: Électronique ou dimmable.
- Température d'utilisation: De -25° C à +55° C.
- Entrée de câbles: Filet M25 (2 entrées).
- Accessoires: 2 colliers d'acier zincé avec protection en caoutchouc (inclus).
- Essai du fil incandescent: Ininflammable.



Ficha técnica
Technical data
Fiche technique

Las abrazaderas pueden desplazarse a lo largo de cualquier punto del tubo de vidrio, dando así flexibilidad para una instalación más sencilla.

The clamps can move freely throughout any point within the glass tube, giving it added flexibility for an easier installation.

Les colliers peuvent être déplacés sur toute la longueur du tube de verre, ce qui permet une installation plus simple.

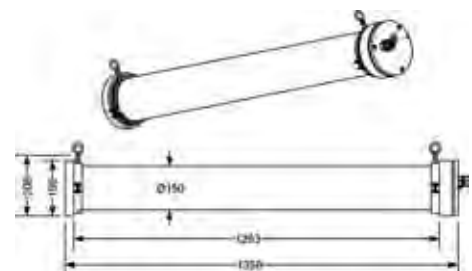

1 TUBO FLUORESCENTE / 1 LAMP / 1 LAMPE

G 13
T8

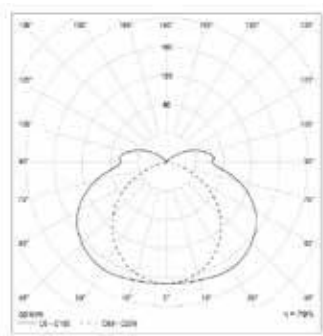

Ref.	Potencia Watts Puissance	Equipo Equipment Ballast	Largo Length Longueur	Raee EU Recyclable tax Ecotaxe	Precio Price Prix
EX201	18 W	●	748	0,70 €	1010,94 €
EX202	18 W	●	748	0,70 €	1050,94 €
EX203	36 W	●	1.357	0,70 €	1316,85 €
EX204	36 W	●	1.357	0,70 €	1356,85 €

● Electrónica / Electronic / Électronique

● Regulable / Dimmable / Gradable

2 TUBOS FLUORESCENTES / 2 LAMPS / 2 LAMPES

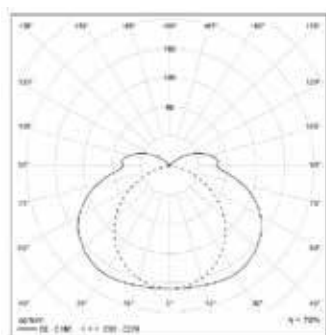

Ref.	Potencia Watts Puissance	Equipo Equipment Ballast	Largo Length Longueur	Raee EU Recyclable tax Ecotaxe	Precio Price Prix
EX205	18 W	●	748	0,70 €	1020,45 €
EX206	18 W	●	748	0,70 €	1060,45 €
EX207	36 W	●	1.357	0,70 €	1329,40 €
EX208	36 W	●	1.357	0,70 €	1369,40 €

● Electrónica / Electronic / Électronique

● Regulable / Dimmable / Gradable

Kit de emergencia 4,8 V - 4,0 Ah
Emergency kit 4,8 V - 4,0 Ah
 Éclairage de secours 4,8 V - 4,0 Ah

REF. OEM05 150,45 €

3.2

Atex Ex Atex

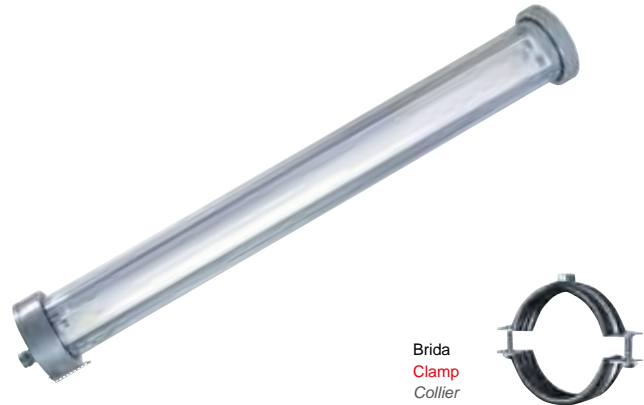

Brida
Clamp
Collier

ES

Características generales

- Marcado ATEX 94/9/CE: II 2GD Ex d IIC T6 Gb. Ex t IIIC T85° C Db.
- Temperatura de trabajo: Consultar al fabricante del tubo LED.
- Entrada de cables: Rosca M25 (2 entradas).
- Accesorios: 2 abrazaderas de acero zincado con protección de caucho y 2 cáncamos (incluidos).
- Ensayo hilo incandescente: 960° C.

CONSULTAR TUBOS HOMOLOGADOS PARA ESTA LUMINARIA.

EN

General characteristics

- Marked ATEX 94/9/CE: II 2GD Ex d IIC T6 Gb. Ex t IIIC T85° C Db.
- Working temperature: Ask the LED manufacturer.
- Wiring entry: M25 screw type (2 entries).
- Accessories: 2 zinc covered clamps, with rubber protection and 2 eyebolt holders (included).
- Glow wire test: 960° C.

REQUEST APPROVED LED TUBES FOR THIS LIGHT FITTING.

FR

Caractéristiques générales

- Marquage ATEX 94/9/CE: II 2GD Ex d IIC T6 gB. Ex t IIIC T85°C Db
- Température d'utilisation: Consultez au fabricant du tube LED.
- Entrée de câbles: Filet M25 (2 entrées).
- Accessoires: 2 colliers d'acier zincé avec protection en caoutchouc (inclus).
- Essai du fil incandescent: 960° C.

DEMANDE APPROUVÉ TUBES LED POUR CET APPAREIL.

1 TUBO LED / 1 LED TUBE / 1 TUBE LED

Ref.	Longitud Tubo Tube Length Longueur Tube	Longitud Luminaria Fitting Length Longueur Luminaire	Peso Weight Poids	Raee EU Recyclable tax Ecotaxe	Precio Price Prix
EX201L	600 mms.	748 mms.	9,7	0,70 €	998,94 €
EX203L	1.200 mms.	1.357 mms.	11,5	0,70 €	1304,85 €

2 TUBOS LED / 2 LED TUBES / 2 TUBES LED

Ref.	Longitud Tubo Tube Length Longueur Tube	Longitud Luminaria Fitting Length Longueur Luminaire	Peso Weight Poids	Raee EU Recyclable tax Ecotaxe	Precio Price Prix
EX205L	600 mms.	748 mms.	9,7	0,70 €	1008,45 €
EX207L	1.200 mms.	1.357 mms.	11,5	0,70 €	1317,40 €



Ficha técnica
Technical data
Fiche technique



Tapón EEx d
Plug EEx d
Bouchon EEx d

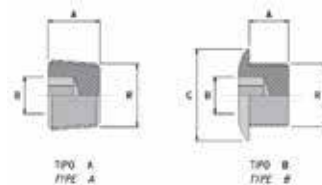

II 2 GD EEx d IIC T6

Ref.	Tamaño de rosca (R) Thread size Taille du filet (R)		Dimensiones Dimensions Dimensions			Precio Price Prix
	Métrica / Metrics / Métrique		A	B	C	
	EX501	M-25		15	10	30



Prensaestopa EEx d
Cablegland EEx d
Presse-étoupe EEx d

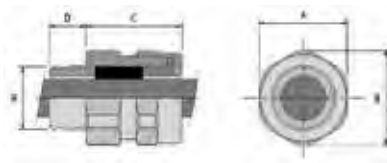

II 2 GD EEx d IIC T6

Ref.	Tamaño de rosca (R) Thread size Taille du filet (R)					Dimensiones Dimensions Dimensions				Ø Exterior Ø Overall Ø Extérieur			Precio Price Prix
	Métrica Metrics Métrique	PG.	NPT	Gas cónica Gas conic Gaz conique		A	B	C	D	Min.	Max.	Tipo Type Type	
EX503	M-25 x 1,5	16 21	3/4" 1"	3/4" 1"	35	39	42	15	9	12	B	45,79 €	
EX504	M-25 x 1,5	16 21	3/4" 1"	3/4" 1"	35	39	42	15	11	14	C	39,24 €	
EX505	M-25 x 1,5	16 21	3/4" 1"	3/4" 1"	35	39	42	15	13	16	D	39,24 €	
EX506	M-25 x 1,5	16 21	3/4" 1"	3/4" 1"	35	39	42	15	15	18	E	39,24 €	

Para cumplir con lo estipulado en la certificación ATEX de esta luminaria es obligatorio instalarlas con un tapon y un prensaestopas o, en caso de líneas continuas, con dos prensaestopas. Para cables sin armadura

To comply with ATEX certification, is mandatory to install them with 1 end cap and 1 cablegland, or in case of continuous lines, with 2 cableglands. To be used with unarmored cables.

Pour être conforme à la certification ATEX de ce luminaire, il est obligatoire d'utiliser un bouchonnet un presse-étoupes, dans le cas d'une installation en ligne continue deux presses-étoupes. Pour cables non armés.

3.3

Atex Ex Atex



Brida
Clamp
Collier

ES

La luminaria FLAME ha sido diseñada para operar en entornos en los que se pueda formar o estar presente una atmósfera explosiva de acuerdo con la directiva ATEX 94/9/CE., mediante la combinación de Protección por Seguridad Aumentada "e" para gases y Protección por Envolverte "tb" para polvo.

Además, la combinación de policarbonato M1 no propagador de la llama, así como aditivos antiestáticos en el plástico de las tapas la hacen perfecta para zonas con riesgo de explosión o incendio.

Como ejemplos de aplicaciones podemos citar:

- Zonas anexas a bocas de carga y descarga de combustible, en exteriores.
- Zonas colindantes con válvulas y conexiones de conducciones de material inflamable.
- Centrales eléctricas.
- Almacenes de disolventes y pinturas.
- Plantas de tratamiento de residuos y depósitos y zonas de tratamiento de fertilizantes.

Características generales

- Cuerpo luminaria: Tubo de policarbonato anti-UV de 2 mm de espesor retardante de la llama.
- Reflector: Chapa de acero lacada en blanco.
- Tapas: Policarbonato.
- Marcado ATEX 94/9/CE: II 2GD Ex e mb IIC T4 Gb Ex tb IIIC T85°C Db (T95°C para 58W).
- Equipo: Electrónico certificado ATEX.
- Temperatura de trabajo: De -30° C a +50° C.
- Accesorios: 2 bridas de sujeción de acero inoxidable.
- Prensaestopas ATEX incluido.
- Ensayo hilo incandescente: 960 °C.

EN

The FLAME luminaire has been designed to operate in environments in which an explosive atmosphere can be formed or can be present according to ATEX 94/9/CE directive, through the combination of Improved Security Protection "e" for gases and "tb" body protection for dust.

Furthermore, the combination of M1 non flame propagator polycarbonate, as well as antistatic additives in the cap plastic makes it perfect for areas with explosion or fire risks. Examples of applications can be:

- Annexed areas to fuel loading and unloading, outdoors.
- Areas connected to flammable material valves and piping connections.
- Electric power plants.
- Paint and solvent warehouses.
- Waste treatment plants.
- Fertilizer treatment and deposits areas.

General characteristics

- Light fitting body: Polycarbonate tube anti-UV of 2 mm thickness flame retardant.
- Reflector: White lacquered steel.
- End caps: Polycarbonate.
- Marked ATEX 94/9/CE: II 2GD Ex e mb IIC T4 Gb Ex tb IIIC T85°C Db (T95°C para 58W).
- Equipment: Electronic ATEX certified.
- Working temperature: From -30° C to +50° C.
- Accessories: 2 stainless steel clamps.
- ATEX cablegland included.
- Glow wire test: 960 °C.

FR

Le luminaire FLAME a été conçu pour travailler dans des ambiances, où il peut se former ou être présente une atmosphère explosive, d'après la définition de la directive ATEX 94/9/CE, avec une combinaison de Protection par Sécurité Augmentée «e» pour les gaz et Protection «tb» pour les poussières.

De plus, la combinaison du tube de polycarbonate M1 non propagateur de la flamme avec les aditifs antistatiques du plastique des embouts, le font parfait pour les zones avec risques d'incendies ou d'explosion.

Comme exemple d'emplacement, on peut citer :

- Zones à proximité des bombes à essence où on charge et décharge du combustible à l'extérieur.
- Zones à proximité des conductions de matériel inflammable.
- Centrales électriques.
- Dépôts de dissolvants et peintures.
- Industries de traitement d'ordures, industries de production d'engrais.

Caractéristiques générales

- Corps du luminaire: Tube de Polycarbonate anti-UV de 2 mm d'épaisseur, non propagateur de la flamme.
- Réflecteur: Acier laqué blanc.
- Embouts: Polycarbonate.
- Marquage ATEX 94/9/CE: II 2GD Ex e mb IIC T4 Gb Ex tb IIIC T85°C Db (T95°C para 58W).
- Ballast: Électronique certifié ATEX.
- Température d'utilisation: De -30° C à +50° C.
- Accessoires: 2 colliers de fixation en acier inoxydable. Presse-étoupe ATEX inclus.
- Essai du fil incandescent: 960 °C.



Ficha técnica
Technical data
Fiche technique

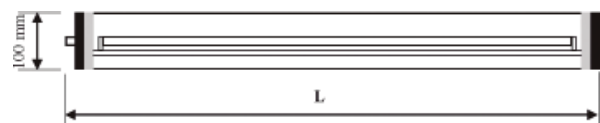

Las luminarias de policarbonato no soportan hidrocarburos

Polycarbonate light fittings don't allow hydrocarbons

Les luminaires de polycarbonate ne supportent pas les hydrocarbures

1 TUBO FLUORESCENTE / 1 LAMP / 1 LAMPE

G 13
T8

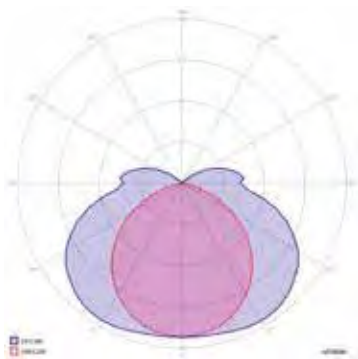

● Electrónica / Electronic / Électronique

Ref.	Potencia Watts Puissance	Equipo Equipment Ballast	Largo Length Longueur	Raee EU Recyclable tax Ecotaxe	Precio Price Prix
EX301	18 W	●	775	0,50 €	407,58 €
EX302	36 W	●	1.385	0,50 €	447,88 €
EX303	58 W	●	1.685	0,50 €	483,22 €

2 TUBOS FLUORESCENTES / 2 LAMPS / 2 LAMPES

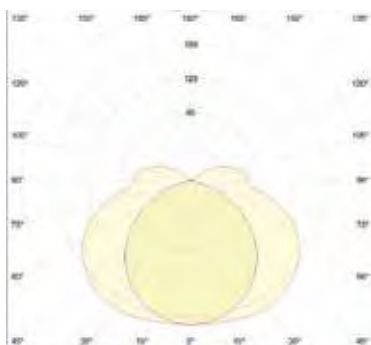

● Electrónica / Electronic / Électronique

Ref.	Potencia Watts Puissance	Equipo Equipment Ballast	Largo Length Longueur	Raee EU Recyclable tax Ecotaxe	Precio Price Prix
EX304	18 W	●	775	0,50 €	435,83 €
EX305	36 W	●	1.385	0,50 €	476,13 €
EX306	58 W	●	1.685	0,50 €	511,47 €

3.4

Atex Ex Atex



Brida
Clamp
Collier

ES

Luminaria fluorescente de **PROTECCIÓN "n" y respiración restringida, categoría 3G y D** con un grado IP68 que ofrece una protección total contra el polvo y la penetración de agua en inmersión prolongada. Gracias a su material constructivo esta luminaria es IK10, el mayor grado de protección contra impacto aplicable a las luminarias. Al ser específicamente diseñada para Zonas ATEX 2 y 22 (Antichispas), es apta para su instalación en lugares donde puedan aparecer, de forma esporádica, y nunca en servicio normal, gases o polvo potencialmente explosivos.

Características generales

- Cuerpo luminaria: Tubo de policarbonato anti-UV de 3,5 mm de espesor.
- Reflector: Aluminio especular.
- Tapas: ABS con tratamiento antiestático.
- Marcado ATEX 94/9/CE: Zona 2: Ex II 3GD Ex nR IIC T6 Gc. Zona 22: Ex t IIIC T85° C Dc.
- Equipo: Electrónico.
- Temperatura de trabajo: De -15° C a +55° C.
- Accesorios: 2 bridas de sujeción de acero cincado.
- Opcionalmente bridas en plástico antiestático.
- Prensaestopas ATEX incluido.
- Ensayo hilo incandescente: 960 °C.



Ficha técnica
Technical data
Fiche technique

EN

This light fitting is a **PROTECTION "n" and restricted breathing, 3G and D category** with an IP68 degree, which allows a total protection against dust and against water penetration during a long time. Impact protection is IK10, the best protection degree available for a luminaire. **SECURE** is specifically designed for ATEX 2 and 22 zones, and is adequate for places where occasionally may appear dust or atmosphere potentially explosive, but never as usual condition.

General characteristics

- Light fitting body: Polycarbonate tube anti-UV of 3,5 mm thickness.
- Reflector: Glossy aluminium.
- End caps: ABS with antistatic treatment.
- Marked ATEX 94/9/CE: Zone 2: Ex II 3GD Ex nR IIC T6 Gc. Zone 22: Ex t IIIC T85° C Dc.
- Equipment: Electronic.
- Working temperature: From -15° C to +55° C.
- Accessories: 2 zinc-plated steel clamps.
- Optionally antistatic plastic clamps.
- ATEX cablegland included.
- Glow wire test: 960 °C.

FR

Ce luminaire fluorescent de **PROTECTION "n" et respiration limitée, catégorie 3G et D** possède un degré de protection IP68 qui offre une protection totale face à poussière et face à la pénétration d'eau en immersion prolongée. Grâce au matériel de l'enveloppe, ce luminaire est IK10, le plus haut degré de protection face aux impacts applicables aux luminaires. Comme ce luminaire est spécifiquement conçu pour des Zones ATEX 2 et 22 (pas de production d'étincelles), il peut être installé dans des endroits où ils peuvent apparaître de façon sporadiques, et jamais dans un service normal, gaz et poussières potentiellement explosifs.

Caractéristiques générales

- Corps du luminaire: Tube de polycarbonate anti-UV de 3,5 mm de épaisseur.
- Réflecteur: Tôle d'aluminium brillant.
- Embouts: ABS avec traitement antistatique.
- Marquage ATEX 94/9/CE: Zone 2: Ex II 3GD Ex nR IIC T6 Gc. Zone 22: Ex t IIIC T85° C Dc.
- Ballast: Électronique.
- Température d'utilisation: De -15° C à +55° C.
- Accessoires: 2 colliers antivandalisme en inox.
- Option de colliers en plastique antistatique.
- Presse-étoupe ATEX (inclus).
- Essai du fil incandescent: 960 °C.

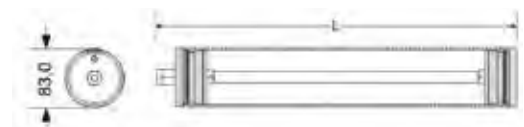

1 TUBO FLUORESCENTE / 1 LAMP / 1 LAMPE

G 13
T8

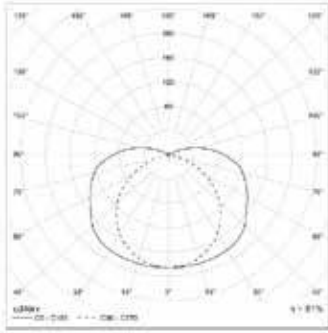

Ref.	Potencia Watts Puissance	Equipo Equipment Ballast	Largo Length Longueur	Raee EU Recyclable tax Ecotaxe	Precio Price Prix
EX601	18 W	●	709	0,70 €	263,12 €
EX602	36 W	●	1.319	0,70 €	364,37 €
EX603	58 W	●	1.624	0,70 €	395,14 €

● Electrónica / Electronic / Électronique

2 TUBOS FLUORESCENTES / 2 LAMPS / 2 LAMPES

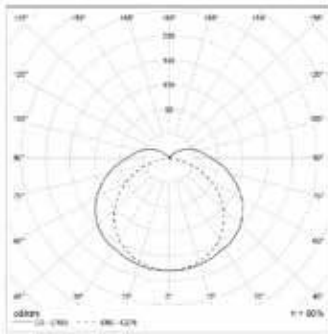

Ref.	Potencia Watts Puissance	Equipo Equipment Ballast	Largo Length Longueur	Raee EU Recyclable tax Ecotaxe	Precio Price Prix
EX612	18 W	●	709	0,70 €	269,98 €
EX613	36 W	●	1.319	0,70 €	369,34 €
EX614	58 W	●	1.624	0,70 €	404,98 €

● Electrónica / Electronic / Électronique

3.4

Atex Ex Atex

1 TUBO FLUORESCENTE / 1 LAMP / 1 LAMPE

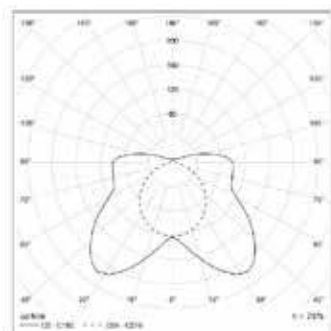
 G5
T5

Ref.	Potencia Watts Puissance	Equipo Equipment Ballast	Largo Length Longueur	Raee EU Recyclable tax Ecotaxe	Precio Price Prix
Alta Eficacia / High Efficiency / Haute Efficacité					
EX604	14 W	●	671	0,50 €	267,27 €
EX605	21 W	●	966	0,50 €	311,85 €
EX606	28 W	●	1.272	0,50 €	357,52 €
EX607	35 W	●	1.574	0,50 €	403,68 €
Alto Rendimiento / High Output / Flux Élevé					
EX608	24 W	●	671	0,50 €	267,31 €
EX609	39 W	●	966	0,50 €	312,34 €
EX610	49 W	●	1.272	0,50 €	406,83 €
EX611	54 W	●	1.574	0,50 €	363,38 €

● Electrónica / Electronic / Électronique

2 TUBOS FLUORESCENTES / 2 LAMPS / 2 LAMPES

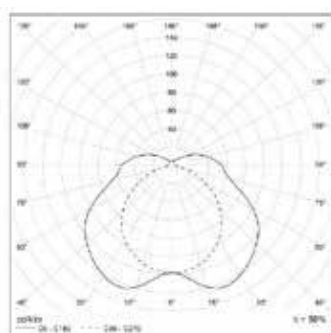

Ref.	Potencia Watts Puissance	Equipo Equipment Ballast	Largo Length Longueur	Raee EU Recyclable tax Ecotaxe	Precio Price Prix
Alta Eficacia / High Efficiency / Haute Efficacité					
EX615	14 W	●	671	0,50 €	279,08 €
EX616	21 W	●	966	0,50 €	323,62 €
EX617	28 W	●	1.272	0,50 €	372,16 €
EX618	35 W	●	1.574	0,50 €	414,95 €
Alto Rendimiento / High Output / Flux Élevé					
EX619	24 W	●	671	0,50 €	279,08 €
EX620	39 W	●	966	0,50 €	350,20 €
EX621	49 W	●	1.272	0,50 €	435,25 €
EX622	54 W	●	1.574	0,50 €	371,80 €

● Electrónica / Electronic / Électronique

ACCESORIOS SECURE / SECURE ACCESSORIES / ACCESSOIRES SECURE

REF. EX623

6,50 €



Bridas en plástico antiestático
(2 uds.)

Antistatic plastic clamps
(2 units)

Colliers en plastique antistatique
(2 uts.)

 Brida
Clamp
Collier

ES

Características generales

- Cuerpo luminaria: Tubo de policarbonato anti-UV de 3,5 mm de espesor.
- Reflector: Aluminio especlar.
- Tapas: ABS con tratamiento antiestático.
- Marcado ATEX 94/9/CE: Zona 2: Ex II 3GD Ex nR IIC Gc. Zona 22: Ex t IIIC Dc.
- Equipo: Electrónico.
- Temperatura de trabajo: Consultar al fabricante del tubo LED.
- Accesorios: 2 bridas de sujeción de acero cincado.
- Opcionalmente bridas en plástico antiestático.
- Prensaestopas ATEX incluido.
- Ensayo hilo incandescente: 960 °C.

EN

General characteristics

- Light fitting body: Polycarbonate tube anti-UV of 3,5 mm thickness.
- Reflector: Specular aluminium.
- End caps: ABS with antistatic treatment.
- Marked ATEX 94/9/CE: Zone 2: Ex II 3GD Ex nR IIC Gc. Zone 22: Ex t IIIC Dc.
- Equipment: Electronic.
- Working temperature: Ask the LED manufacturer.
- Accessories: 2 zinc-plated steel clamps.
- Optionally antistatic plastic clamps.
- ATEX cablegland included.
- Glow wire test: 960 °C.

FR

Caractéristiques générales

- Corps du luminaire: Tube de polycarbonate anti-UV de 3,5 mm de épaisseur.
- Réflecteur: Tôle d'aluminium brillant.
- Embouts: ABS avec traitement antistatique.
- Marquage ATEX 94/9/CE: Zone 2: Ex II 3GD Ex nR IIC Gc. Zone 22: Ex t IIIC Dc.
- Ballast: Electronique.
- Température d'utilisation: De -15° C à +55° C.
- Accessoires: 2 colliers antivandalisme en inox.
- Option de colliers en plastique antistatique.
- Presse-étoupe ATEX (inclu).
- Essai du fil incandescent: 960 °C.

1 TUBO LED / 1 LED TUBE / 1 TUBE LED

 G 13
T8

Ref.	Longitud Tubo Tube Length Longueur Tube	Longitud Luminaria Fitting Length Longueur Luminaire	Raee EU Recyclable tax Ecotaxe	Precio Price Prix
EX601L	600 mms.	748 mms.	0,70 €	251,12 €
EX602L	1.200 mms.	1.357 mms.	0,70 €	352,37 €
EX603L	1.500 mms.	1.659 mms.	0,70 €	383,14 €

2 TUBOS LED / 2 LED TUBES / 2 TUBES LED

Ref.	Longitud Tubo Tube Length Longueur Tube	Longitud Luminaria Fitting Length Longueur Luminaire	Raee EU Recyclable tax Ecotaxe	Precio Price Prix
EX612L	600 mms.	748 mms.	0,70 €	257,98 €
EX613L	1.200 mms.	1.357 mms.	0,70 €	357,34 €
EX614L	1.500 mms.	1.659 mms.	0,70 €	392,98 €

 Ficha técnica
Technical data
Fiche technique



Estación de servicio, Los Corrales de Buelna (Cantabria), España - MMiT arquitectos. Javier Terán Alonso, Agustín Montes Gaisán, Alberto Montes Gaisán.
[Gas station, Los Corrales de Buelna \(Cantabria\), Spain](#)
Station-service, Los Corrales de Buelna (Cantabria), Espagne



Estación de servicio, Los Corrales de Buelna (Cantabria), España - MMiT arquitectos. Javier Terán Alonso, Agustín Montes Gaisán, Alberto Montes Gaisán.
[Gas station, Los Corrales de Buelna \(Cantabria\), Spain](#)
Station-service, Los Corrales de Buelna (Cantabria), Espagne



3.5

Atex Ex Atex



ES

Luminaria diseñada para iluminación de minas y espacios subterráneos susceptibles de acumulación de gas Grisú. También puede ser utilizada en otras instalaciones industriales interiores, exteriores o bajo techo.

Características generales

- Cuerpo luminaria: Fundición de hierro con pintura amarilla de poliéster en polvo.
- Marcado ATEX 94/9/CE: Zona 0: I M2 Ex d I Zona 1 y 21: II 2GD Ex d tD A IIB T4-T6.
- Temperatura de trabajo: De -20° C a +40° C.
- Accesorios: Brida de sujeción de acero con agujero de Ø 18 mm.
- Rejilla protectora.
- Bridas para toma de tierra internas y externas.
- Entrada de cables: Caja de conexiones para cableado continuo con doble entrada. Cables de diámetro máximo 4 mm².

EN

Luminaire is designed for mines lighting and underground spaces susceptible to firedamp. It can also be used in other industrial places, indoor, outdoor or under shelter.

General characteristics

- Light fitting body: Grey cast iron treated with polyester powder paint.
- Marked ATEX 94/9/CE: Zone 0: I M2 Ex d I Zone 1 and 21: II 2GD Ex d tD A IIB T4-T6.
- Working temperature: From -20° C to +40° C.
- Accessories: Steel pendant with eye Ø 18 mms.
- Cover from grey cast iron.
- Steel basic plate with electric part and reflector fixed in the body.
- Wiring input: 2 inner and 2 outer earthing clamps for conductive connection. Max. section of connecting conductors 4 mm².

FR

Luminaire conçue pour éclairage de mines et espaces souterrains ou il y a risque de concentration de gaz Grisou. Aussi, il peut être utilisé dans d'autres installations industrielles intérieures, extérieurs ou couvertes.

Caractéristiques générales

- Corps du luminaire: Fondrière de fer avec peinture jaune de polyester en poudre.
- Marquage ATEX 94/9/CE: Zone 0: I M2 Ex d I Zone 1 et 21: II 2GD Ex d tD A IIB T4-T6.
- Température d'utilisation: De -20° C à +40° C.
- Accessoires: Étrier de fixation d'acier avec ouverture de Ø 18 mm.
- Grille de protection.
- Étrier pour prise de terre interne et externe.
- Entrée de câbles: Boîte de connexions pour câblage continue avec double entrée. Fil de diamètre maximum de 4 mm².



Ficha técnica
Technical data
Fiche technique

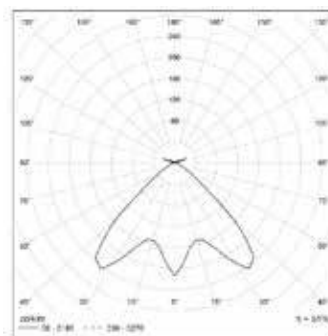
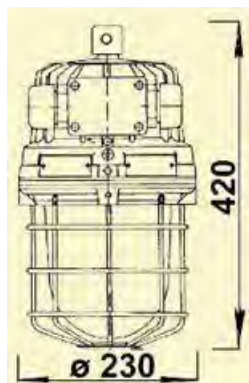

Incandescent - E27

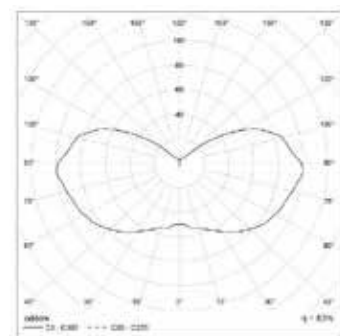

V. de Mercurio / Mercury - E27

Ref.	Fuente de luz Light source Type de source	Clase temperatura Temperature classe Classe de température	Peso Weight Poids	Raee EU Recyclable tax Ecotaxe	Precio Price Prix
EX101	Incandescent 200 W E27	T4	18	0,70 €	1.044,44 €
	Incandescent 150 W E27	T5			
	Incandescent 60-100 W E27	T6			
	Compact 23 W E27	T6			
	Luz mezcla / Mixed-light / Lampe mixte 160 W E27	T5			
	Incandescent 100 W E27	T5			
EX102	V. de Sodio / Sodium 50 W E27	T4	19	0,70 €	1.091,67 €
EX103	V. de Sodio / Sodium 110 W E27	T4	19	0,70 €	1.072,22 €
EX105	Compact TC-D (G24d-3)	T6	19,5	0,70 €	1.052,78 €

ACCESORIOS MINEX / MINEX ACCESSORIES / ACCESSOIRES MINEX

REF. EX106	19,62 €	REF. EX107	338,56 €	REF. EX108	98,46 €
					
Rejilla protección sobre vidrio Protective guard Grille de protection pour le verre		Vidrio de repuesto Flange with glass Verre de remplacement		Campana reflectora Lampshare Réflecteur	
REF. EX109	23,49 €	REF. EX110	3,62 €	REF. EX111	62,50 €
					
Sujeción a techo Holder for immovable fixing to ceiling Fixation au plafond		Tapón ciego Antivandalic polycarbonate Embout		Filtro rojo Optical red insert Filtre rouge	
REF. EX112	68,07 €	REF. EX113	42,39 €	REF. EX114	196,14 €
					
Filtro verde Optical green insert Filtre vert		Vidrio con reflector (maximo 60 W) Optical clear with refractor for signalling purposes Verre avec réflecteur (maximum 60 W)		Llave de apertura de luminaria Wrench M 205 x 2 type Clé d'ouverture du luminaire	
REF. EX115	83,42 €				
					
Brida prensaestopas para cables Ø 16-20 mm. Flange cable grand Presse-étoupe pour câbles de Ø 16-20 mm.					

3.6

Atex Ex Atex



ES

Luminaria diseñada para iluminación de espacios industriales que NO sean minas, especialmente lugares con techos muy altos. Entre sus aplicaciones podemos citar:

- Lugares donde se trasvasen líquidos volátiles inflamables.
- Garajes y talleres de reparación de vehículos.
- Secaderos de material con disolventes inflamables.
- Locales de extracción de grasas y aceites que utilicen disolventes inflamables.
- Locales con depósitos de líquidos inflamables abiertos o que se puedan abrir.
- Zonas de lavanderías y tintorerías en las que se empleen líquidos inflamables.
- Salas de gasógenos.
- Instalaciones donde se produzcan, manipulen o consuman gases inflamables.
- Salas de bombas y/o de compresores de líquidos y gases inflamables.
- Interiores de refrigeradores y congeladores en los que se almacenen materias inflamables en recipientes abiertos.

Características generales

- Cuerpo luminaria: Cuerpo en aleación de aluminio ALSI con pintura amarilla de poliéster en polvo.
- Marcado ATEX 94/9/CE: Zona 1 y 21: II 2GD Ex de tD IIC T3-T6.
- Temperatura de trabajo: De -20° C a +50° C.
- Accesorios: Brida de sujeción de acero con agujero de 18 mm.
- Bridas para toma de tierra internas y externas.
- Entrada de cables: Caja de conexiones para cableado continuo con doble entrada. Cables de diámetro máximo 4 mm².

EN

Light fitting designed for industrial space lighting that are NOT mines, especially places with very high ceilings. Amongst its applications are:

- Areas where flammable volatile liquids are transferred.
- Garages and vehicle repair shops.
- Materials drier areas with flammable solvents.
- Grease and Oil Extraction shops that utilize flammable solvents.
- Installations where flammable gases are either produced, manipulated or used.
- Flammable liquid or gas pump or compressor rooms.
- Freezer or refrigerator that store flammable materials in open containers.

General characteristics

- Light fitting body: Light fitting body: aluminum alloy ALSI with polyester powder yellow paint.
- Marked ATEX 94/9/CE: Zone 1 and 21: II 2GD Ex de tD IIC T3-T6
- Working temperature: From -20° C to +50° C.
- Accessories: Steel pendant with eye Ø 18 mms.
- Steel basic plate with electric part and reflector fixed in the body.
- Wiring input: 2 inner and 2 outer earthing clamps for conductive connection. Max. section of connecting conductors 4 mm².

FR

Luminaire conçu pour l'éclairage d'espaces industriels (PAS mines), spécialement pour emplacements à une grande hauteur. Exemples d'applications :

- Lieux où des liquides inflammables volatils sont manipulés.
- Garages et parkings.
- Séchoirs de matériaux avec des dissolvants inflammables.
- Locaux d'extraction d'huiles et graisses avec des dissolvants inflammables.
- Entrepôts de stockage de liquides inflammables.
- Locaux de gaz.
- Caractéristiques.

Caractéristiques générales

- Corps du luminaire: Corps du luminaire: aluminium alliage ALSI avec peinture jaune à poudre de polyester.
- Marquage ATEX 94/9/CE: Zone 1 et 21: II 2GD Ex de tD IIC T3-T6
- Température d'utilisation: De -20° C à +50° C.
- Accessoires: Étrier de fixation d'acier avec ouverture de 18 mm.
- Étrier pour prise de terre interne et externe.
- Entrée de câbles: Boîte de connexions pour câblage continu avec double entrée. Fil de diamètre maximum de 4 mm².



Ficha técnica
Technical data
Fiche technique

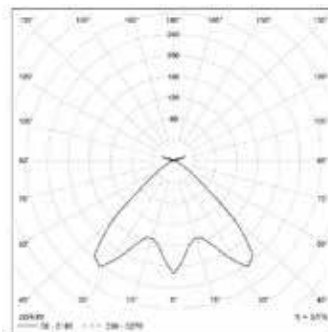
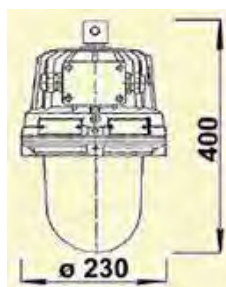

Incandescent - E27

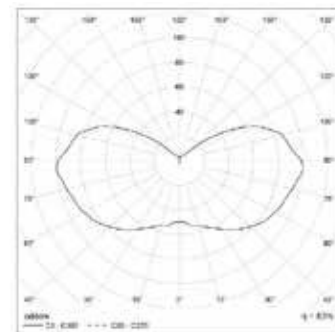

V. de Mercurio / Mercury - E27

Ref.	Fuente de luz Light source Type de source	Clase temperatura Temperature classe Classe de température	Peso Weight Poids	Raee EU Recyclable tax Ecotaxe	Precio Price Prix
EX116	Incandescent 200 W E27	T4	8	0,70 €	708,33 €
	Incandescent 150 W E27	T4			
	Incandescent 60-100 W E27	T5			
	Luz mezcla / Mixed-light / Lampe mixte 160 W E27	T4			
EX117	V. de Sodio / Sodium 50 W E27	T4	8	0,70 €	752,78 €
EX118	V. de Sodio / Sodium 110 W E27	T3	9	0,70 €	752,78 €
EX119	Compact TC-D (G24d-3)	T6	9	0,70 €	730,56 €

Existe una versión bajo demanda para temperaturas entre -20° C a 40° C.
 Il existe une version pour des températures comprises entre -20 ° C à 40 ° C.
 There is a version for temperatures between -20 ° C to 40 ° C.

ACCESORIOS LUMEX / LUMEX ACCESSORIES / ACCESSOIRES LUMEX

REF. EX106	19,62 €	REF. EX120	236,55 €	REF. EX108	98,46 €
					
Rejilla protección sobre vidrio Protective guard Grille de protection pour le verre		Vidrio de repuesto Flange with glass Verre de remplacement		Campana reflectora Lampshare Réflecteur	
REF. EX109	23,49 €	REF. EX121	3,35 €	REF. EX122	6,15 €
					
Sujeción a techo Holder for immovable fixing to ceiling Fixation au plafond		Tapón ciego Antivandalic polycarbonate Embout		Tapón roscado Blinding screw Embout fileté	
REF. EX111	62,50 €	REF. EX111	68,07 €	REF. EX113	42,39 €
					
Filtro rojo Optical red insert Filtre rouge		Filtro verde Optical green insert Filtre vert		Vidrio con reflector (maximo 60 W) Optical clear with refractor for signalling purposes Verre avec réflecteur (maximum 60 W)	
REF. EX114	196,14 €				
					
Llave de apertura de luminaria Wrench M 205 x 2 type Clé d'ouverture du luminaire					

3.7

Atex Ex Atex



ES

Luminaria diseñada para iluminación de espacios industriales que NO sean minas, especialmente lugares con techos muy altos. Entre sus aplicaciones podemos citar:

- Lugares donde se trasvasen líquidos volátiles inflamables.
- Garajes y talleres de reparación de vehículos.
- Secaderos de material con disolventes inflamables.
- Locales de extracción de grasas y aceites que utilicen disolventes inflamables.
- Locales con depósitos de líquidos inflamables abiertos o que se puedan abrir.
- Zonas de lavanderías y tintorerías en las que se empleen líquidos inflamables.
- Salas de gasógenos.
- Instalaciones donde se produzcan, manipulen o consuman gases inflamables.
- Salas de bombas y/o de compresores de líquidos y gases inflamables.
- Interiores de refrigeradores y congeladores en los que se almacenen materias inflamables en recipientes abiertos.

Características generales

- Cuerpo luminaria: Cuerpo en aleación de aluminio ALSI.
- Marcado ATEX 94/9/CE: Zona 1 y 21: II 2GD Ex de tD IIC T2-T6
- Temperatura de trabajo: De -20° C a +55° C.
- Accesorios: Brida de sujeción de acero posicionable.
- Bridas para toma de tierra internas y externas.
- Entrada de cables: Caja de conexiones para cableado continuo con doble entrada. Cables de diámetro máximo 4 mm².

EN

Light fitting designed for industrial space lighting that are NOT mines, especially places with very high ceilings. Amongst its applications are:

- Areas where flammable volatile liquids are transferred.
- Garages and vehicle repair shops.
- Materials drier areas with flammable solvents.
- Grease and Oil Extraction shops that utilize flammable solvents.
- Installations where flammable gases are either produced, manipulated or used.
- Flammable liquid or gas pump or compressor rooms.
- Freezer or refrigerator that store flammable materials in open containers.

General characteristics

- Light fitting body: Light fitting body: aluminium alloy body ALSI.
- Marked ATEX 94/9/CE: Zone 1 and 21: II 2GD Ex de tD IIC T2-T6
- Working temperature: From -20° C to +55° C.
- Accessories: Steel pendant.
- Steel basic plate with electric part and reflector fixed in the body.
- Wiring input: 2 inner and 2 outer earthing clamps for conductive connection. Max. section of connecting conductors 4 mm².

FR

Luminaire conçu pour l'éclairage d'espaces industriels (PAS mines), spécialement pour emplacements à une grande hauteur. Exemples d'applications :

- Lieux où des liquides inflammables volatils sont manipulés.
- Garages et parkings.
- Séchoirs de matériaux avec des dissolvants inflammables.
- Locaux d'extraction d'huiles et graisses avec des dissolvants inflammables.
- Entrepôts de stockage de liquides inflammables.
- Locaux de gaz.

Caractéristiques générales

- Corps du luminaire: Corps du luminaire : aluminium alliage ALSI.
- Marquage ATEX 94/9/CE: Zone 1 et 21: II 2GD Ex de tD IIC T2-T6
- Température d'utilisation: De -20° C à +55° C.
- Accessoires: Étrier de fixation d'acier.
- Étrier pour prise de terre interne et externe.
- Entrée de câbles: Boîte de connexions pour câblage continu avec double entrée. Fil de diamètre maximum de 4 mm².



Ficha técnica
Technical data
Fiche technique

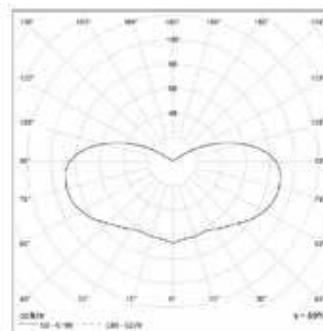

Ref.	Fuente de luz Light source Type de source	Clase temperatura Temperature classe Classe de température	Peso Weight Poids	Raee EU Recyclable tax Ecotaxe	Precio Price Prix
EX131	V. de Sodio / Sodium 210 W E40	T4	26	0,70 €	1.377,04 €
EX132	V. de Sodio / Sodium 350 W E40	T2	27	0,70 €	1.386,37 €
EX133	H. Metalicos / Metal Halide 250 W E40	T3	26	0,70 €	1.482,73 €
	V. de Sodio / Sodium 250 W E40	T3	26		
EX134	V. de Sodio / Sodium 400 W E40	T2	27	0,70 €	1.482,73 €
EX135	H. Metalicos / Metal Halide 400 W E40	T2	27	0,70 €	1.516,92 €
EX136	H. Metalicos / Metal Halide 150 W E40	T5	25	0,70 €	1.392,59 €
	V. de Sodio / Sodium 150 W E40	T5	25		

ACCESORIOS MINEX / MINEX ACCESSORIES / ACCESSOIRES MINEX

REF. EX137

78,34 €



Rejilla protección sobre vidrio
Protective guard
Grille de protection pour le verre

REF. EX138

328,20 €



Vidrio de repuesto
Flange with glass
Verre de remplacement

REF. EX139

153,67 €



Campana reflectora
Lampshare
Réflecteur

REF. EX121

3,35 €



Tapón ciego
Antivandalic polycarbonate
Embout

REF. EX122

6,15 €



Tapón roscado
Blinding screw
Embout fileté

REF. EX140

171,18 €



Llave de apertura de luminaria
Wrench M 205 x 2 type
Clé d'ouverture du luminaire

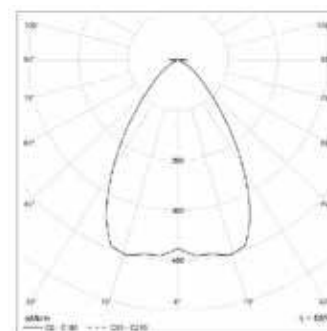

Taurus con campana reflectora
Taurus with lampshare
Taurus avec réflecteur

3.8

Atex
Ex
Atex

	Categoría de aparatos Fixture category <i>Catégorie des appareils</i>	Ex	Modo de protección Protection mode <i>Mode de protection</i> d	Grupo de gases Gases group <i>Groupe de gaz</i> IIC	Clase de temperatura Temperature class <i>Classe de température</i> T6	Protección gases Gases protection <i>Protection aux gaz</i> Gb
	II 2 GD	Ex	Modo de protección Protection mode <i>Mode de protection</i> t	Grupo de polvos Dusts group <i>Groupe de poussières</i> IIIC	Clase de temperatura Temperature class <i>Classe de température</i> T85° C	Protección polvo Dust protection <i>Protection aux poussières</i> Db

CLASIFICACIÓN DE LAS ZONAS ATEX
EX ZONE CLASSIFICATION
CLASSIFICATION DES ZONES ATEX

Aparatos del Grupo II: Industrias de superficie
Group II Fixtures: Above ground industries
Appareils du Groupe II: Industrie de surface

Zona Zone <i>Zone</i>	Categoría Category <i>Catégorie</i>	Presencia de ambientes explosivos Explosive environment presence <i>Présence d'ambiance explosive</i>
Zona / Zone / Zone 0 Zona / Zone / Zone 20	1G (gases y vapores / gases & vapors / <i>gaz et vapeurs</i>) 1D (polvos / dusts / <i>poussières</i>)	Constante, permanente Constant, permanent <i>Permanet, constant</i>
Zona / Zone / Zone 1 Zona / Zone / Zone 21	2G (gases y vapores / gases & vapors / <i>gaz et vapeurs</i>) 2D (polvos / dusts / <i>poussières</i>)	Ocasional, frecuente Occasional, frequent <i>Fréquent, occasionnel</i>
Zona / Zone / Zone 2 Zona / Zone / Zone 22	3G (gases y vapores / gases & vapors / <i>gaz et vapeurs</i>) 3D (polvos / dusts / <i>poussières</i>)	Nunca en servicio normal, solo durante breves periodos de tiempo Never in a normal service, only for short periods of time <i>Jamais pour un service normal, unique ment durant des brèves périodes</i>

Aparatos del Grupo I: Minas con Grisú
Group I Fixtures: Mines with fire-damp
Appareils du Groupe I: Mines avec du grisou

M1	Presencia (metano, polvo) Presence (methane, dust) <i>Présence (méthane, poussière)</i>
M2	Riesgo de presencia (metano, polvo) Presence Risk (methane, dust) <i>Risque de présence (méthane, poussière)</i>

MODOS DE PROTECCIÓN / PROTECTION MODES / MODES DE PROTECTION

Símbolo Symbol <i>Symbole</i>	Categoría Category <i>Catégorie</i>	Zona Zone <i>Zone</i>
d	Antideflagrante / Explosion proof / <i>Enveloppe antidéflagrante</i>	1,2
e	Seguridad aumentada / Increased security / <i>Sécurité augmentée</i>	1,2
ia	Seguridad intrínseca / Intrinsic security / <i>Sécurité intrinsèque</i>	0,1,2
ib	Seguridad intrínseca / Intrinsic security / <i>Sécurité intrinsèque</i>	1,2
o	Inmersión en aceite / Oil immersion / <i>Immersion en huile</i>	2
p	Presurizado / Pressurized / <i>Surpression</i>	1,2
q	Bajo arena / Below sand / <i>Remplissage de l'enveloppe par un matériau pulvérulent</i>	1,2
m	Encapsulado / Encapsulated / <i>Encapsulage</i>	1,2
n	Antichispas / Antisparks / <i>Pas de production d'étincelles</i>	2

CLASIFICACIÓN DE LOS GASES SEGÚN SU TEMPERATURA DE IGNICIÓN (*)
GAS CLASSIFICATION ACCORDING TO IGNITION TEMPERATURE (*)
CLASSIFICATION DES GAZ SELON LEURTEMPÉRATURES D'IGNITION (*)

Grupos Groups Groupes	Gases Gases Gaz	Clases de temperatura Temperature classes Classe de températures					
		T1	T2	T3	T4	T5	T6
I	Metano (Grisú) / Methane (Fire-damp) / Méthane (Grisou)	•					
	Acetona / Acetone / Acétone	•					
	Ácido acético / Acetic acid / Acide acétique	•					
	Amoniaco / Ammonia / Ammoniac	•					
	Etano / Ethane / Éthane	•					
	Cloruro de metileno / Methylene chloride / Dichlorométhane/Chlorure de méthylène	•					
	Metano (CH4) / Methane (CH4) / Méthane (CH4)	•					
	Óxido de carbono / Carbon oxide / Oxyde de carbone	•					
	Propano / Propane / Propane	•					
	N-Butano / N-Butane / N-Butane		•				
II	N-Butil / N-Butyl / N-Butil		•				
	N-Hexano / N-Hexane / N-Hexane			•			
	Acetaldehído / Acetaldehyde / Éthanal/Acétaldéhyde				•		
	Eter etílico / Ethyl ether / Éther diéthylique/éthoxyéthane				•		
	Nitrito de etilo / Ethyl nitrite / Nitrite d'éthyle						•
	Etileno / Ethyl / Éthylène		•				
	Etil Óxido / Ethyl Oxide / Éthylène oxyde		•				
	Hidrógeno sulfurado / Sulfur Hydrogen / Sulfure d'hydrogène			•			
	Acetileno (C2H2) / Acetylen (C2H2) / Acétylène (C2H2)		•				
	Sulfuro de carbono (CS2) / Carbon Sulfur (CS2)/ Sulfure de carbone (CS2)						•
C	Hidrógeno (H2) / Hydrogene (H2) / Hydrogène(H2)	•					

(*) El material marcado como IIB se adapta a las aplicaciones que exigen material marcado como IIA, y IIC se adapta para IIA y IIB.

The material marked as IIB adapts to applications that require marked material as IIA, and IIC adapts to IIA & IIB.

Le matériel marqué comme IIB s'adapte aux applications exigées par le matériel marqué comme IIA, ainsi que le groupe IIC s'adapte pour IIA et IIB.

Temperatura máxima de la superficie (°C) Surface maximum temperature (°C) Température maximale de la surface (°C)	Clases de temperatura Temperature classes Classe de températures
T1	450
T2	300
T3	200
T4	135
T5	100
T6	85

3.9

Atex
Ex
Atex

Zona Zone	ATEX	
0	MINEX	<p>Minería bajo tierra, incluyendo las que tengan riesgo de acumulación de gas grisú Underground mining, including those who are at risk of accumulation of firedamp <i>Exploitation minière souterraine, et qui sont à risque d'accumulation de grisou</i></p>
1 y 21	PYROS LUMEX FLAME TAURUS	<p>Zonas inmediatas a bocas de carga y descarga de combustible en exteriores Zone close to fuel valve and pumps <i>Zones adjacentes aux orifices de remplissage et de décharge de carburabant</i></p> <p>Zona colindantes con válvulas y conexiones de conducciones de m. inflamable Zone close to valves and connectors in flammable pipes <i>Zones situées à proximité de robinets et de raccordements de m. inflammable</i></p> <p>Almacenes de disolventes, pinturas o adhesivos volátiles Solvent, paint or glue warehouses <i>Entrepôts de solvants, de peintures ou d'adhésifs volatils</i></p> <p>Zonas cerradas (piscinas de fangos) de tratamiento de residuos urbanos Urban waste treatment centers (closed rooms) <i>Zones confinées (bassins de boues) destinées au traitement de déchets urbains</i></p> <p>Depósitos y zonas de manipulación de fertilizantes Fertilizer handling zones and warehouses <i>Dépôts et zones de manipulation d'engrais</i></p>
1 y 21	LUMEX VITRA TAURUS	<p>Laboratorios con riesgo por manipulación de proyecciones de líquidos corrosivos Laboratories where corrosive liquid projections or heavy oil are possible <i>Laboratoires exposés +a des risques de projection de liquides corrosifs</i></p> <p>Cabinas de pintura con proyección de disolventes para limpieza Paint booth where solvents are used to cleaning operations <i>Cabines de peinture dans solvants sont projetés à des fins de nettoyage</i></p> <p>Zonas de producción con emisión de productos abrasivos (cloro) Production zones where abrasives (chlorine) are present <i>Zones de production caractérisées par l'émission de produits abrasifs (chlore)</i></p> <p>Conducciones de extracción de polvo (cementeras, extractores de cereales, etc.) Dust extraction pipe (cement factorys, grain extractors, etc.) <i>Conduites d'extraction de poussière (cimenteries, extracteurs de céréales, etc.)</i></p>
2 y 22	SECURE	<p>Fosos de talleres Garage trenches <i>Fosses de garage</i></p> <p>Zonas de carga / descarga de cereales a cielo abierto Loading and unloading grain zones (open areas) <i>Zones de chargement / déchargement de céréales à ciel ouvert</i></p> <p>Almacenes de maquinaria (agrícola, industrial, etc.) Machinery warehouse (farming, industrial, etc.) <i>Entrepôts déquipements (agricoles, industriels, etc.)</i></p> <p>Talleres de carpintería, barnizado de muebles Carpentry workshop, furniture varnishing <i>Ateliers de menuiserie, vernissage de meubles</i></p> <p>Surtidores de combustible (gasolineras). Zona no inmediata a las bocas de surtidor Fuel pumps (Gas stations, not immediate areas) <i>Pompes à essence (stations-service), zone non adjacente aux becs des pompes</i></p>

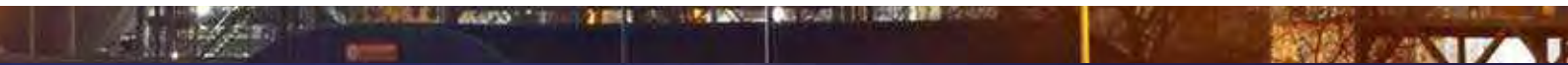



ILUMINACIÓN TÉCNICA

TECHNICAL LIGHTING

ÉCLAIRAGE TECHNIQUE

4.1	REGLETAS Y CARRILES / BATTENS AND TRACKS <i>BATTENS AND TRACKS</i>	
	Delta LED	162
	Minidelta LED	178
4.2	ILUMINACIÓN COMERCIAL / COMMERCIAL LIGHTING <i>ÉCLAIRAGE COMMERCIAL</i>	
	Superdelta	186
	Deco	190
	Metallic	192
4.3	ILUMINACIÓN INDUSTRIAL / INDUSTRIAL LIGHTING <i>ÉCLAIRAGE INDUSTRIEL</i>	
	Extreme	194
	Lumi	196
	Bases y esferas <i>Spheres and sphereholders</i> <i>Bases et sphères</i>	200
	Tubos protectores <i>Protective tubes</i> <i>Tubes de protection</i>	204
4.4	LUMINARIAS HOSPITALARIAS / CLINIC LUMINAIRES <i>CENTRES HOSPITALIERS</i>	
	Sanium	208
4.5	Cuadro de aplicaciones <i>Applications chart</i> <i>Tableau d'applications</i>	210



COMPACT

Puente de Segovia, Madrid, España

Segovia bridge, Madrid, Spain

Pont de Segovia, Madrid, Espagne



COMPACT

Puente de Segovia, Madrid, España

Segovia bridge, Madrid, Spain

Pont de Segovia, Madrid, Espagne

4.1

Iluminación técnica / Regletas y Carriles

Technical lighting / Battens and Tracks

Éclairage technique / Réglettes et rails

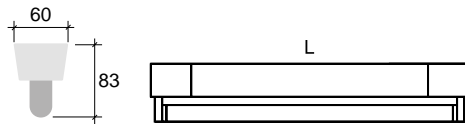

1 TUBO FLUORESCENTE
1 LAMP
1 LAMPE

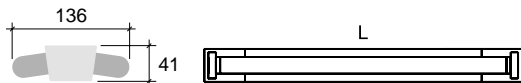

2 TUBOS FLUORESCENTES
2 LAMPS
2 LAMPES

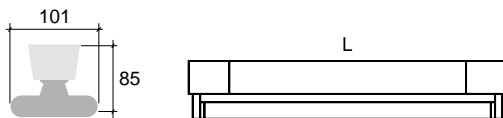

PORTALÁMPARAS DOBLE 2 TUBOS FLUORESCENTES
DOUBLE LAMPHOLDER 2 LAMPS
PORTE LAMPES DOUBLE 2 LAMPES



ES

Características generales

- Cuerpo luminaria: Chapa acero prelacada.
- Reflector (opcional): Aluminio brillante o chapa acero prelacada.
- Tapas finales: A.B.S.
- Temperatura de trabajo: De -15° C a +45° C.

EN

General characteristics

- Light fitting body: Lacquered steel.
- Reflector (optional): Glossy aluminium or lacquered steel.
- End caps: A.B.S.
- Working temperature: From -15° C to +45° C.

FR

Caractéristiques générales

- Corps du luminaire: Acier laqué.
- Réflecteur (optionnel): Aluminium brillant ou acier laqué.
- Embouts: A.B.S.
- Température d'utilisation: De -15° C à +45° C.



Ficha técnica
Technical data
Fiche technique

1 TUBO FLUORESCENTE / 1 LAMP / 1 LAMPE

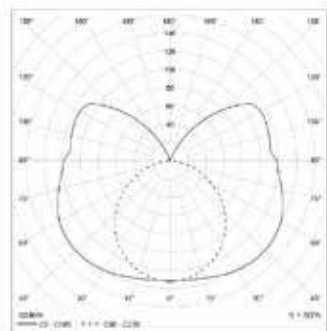

Ref.	Potencia Watts Puissance	Equipo Equipment Ballast	Largo Length Longueur	Raee EU Recyclable tax Ecotaxe	Precio Price Prix
D0001	15 W	●	471	0,50 €	14,96 €
D0007	15 W	●	471	0,50 €	17,22 €
D0002	18 W	●	624	0,50 €	14,19 €
D0008	18 W	●	624	0,50 €	16,10 €
D0049	18 W	●	624	0,50 €	29,02 €
D0133	18 W	●	624	0,50 €	69,02 €
D0004	30 W	●	928	0,50 €	18,38 €
D0010	30 W	●	928	0,50 €	20,62 €
D0005	36 W	●	1.233	0,50 €	16,77 €
D0011	36 W	●	1.233	0,50 €	18,70 €
D0050	36 W	●	1.233	0,50 €	29,66 €
D0134	36 W	●	1.233	0,50 €	69,66 €
D0006	58 W	●	1.534	0,50 €	20,59 €
D0012	58 W	●	1.534	0,50 €	22,79 €
D0051	58 W	●	1.534	0,50 €	30,99 €
D0135	58 W	●	1.534	0,50 €	70,99 €

- Bajo factor / Low factor / Non-compensé
- Alto factor / High factor / Compensé
- Electrónica / Electronic / Electronique
- Regulable / Dimmable / Gradable

2 TUBOS FLUORESCENTES / 2 LAMPS / 2 LAMPES

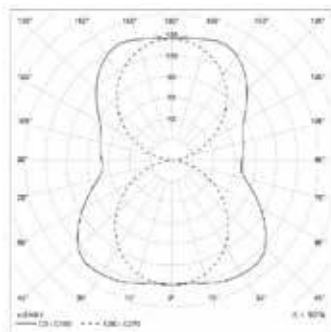

Ref.	Potencia Watts Puissance	Equipo Equipment Ballast	Largo Length Longueur	Raee EU Recyclable tax Ecotaxe	Precio Price Prix
D0013	15 W	●	471	0,50 €	18,99 €
D0019	15 W	●	471	0,50 €	21,23 €
D0014	18 W	●	624	0,50 €	16,45 €
D0020	18 W	●	624	0,50 €	18,83 €
D0052	18 W	●	624	0,50 €	30,34 €
D0136	18 W	●	624	0,50 €	70,44 €
D0016	30 W	●	928	0,50 €	29,64 €
D0022	30 W	●	928	0,50 €	32,84 €
D0017	36 W	●	1.233	0,50 €	26,54 €
D0023	36 W	●	1.233	0,50 €	29,11 €
D0053	36 W	●	1.233	0,50 €	33,02 €
D0137	36 W	●	1.233	0,50 €	73,02 €
D0018	58 W	●	1.534	0,50 €	33,22 €
D0024	58 W	●	1.534	0,50 €	36,79 €
D0054	58 W	●	1.534	0,50 €	34,06 €
D0138	58 W	●	1.534	0,50 €	74,06 €

- Bajo factor / Low factor / Non-compensé
- Alto factor / High factor / Compensé
- Electrónica / Electronic / Electronique
- Regulable / Dimmable / Gradable

4.1

Iluminación técnica / Regletas y Carriles

Technical lighting / Battens and Tracks

Éclairage technique / Réglettes et rails

PORTALÁMPARAS DOBLE, 2 FLUORESCENTES

DOUBLE LAMPHOLDER 2 LAMPS

PORTE LAMPES DOUBLE, 2 LAMPES

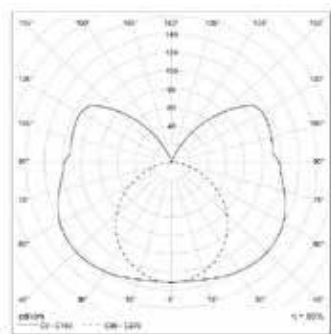

- Bajo factor / Low factor / Non-compensé
- Alto factor / High factor / Compensé
- Electrónica / Electronic / Électronique
- Regulable / Dimmable / Gradable

Ref.	Potencia Watts Puissance	Equipo Equipment Ballast	Largo Length Longueur	Raee EU Recyclable tax Ecotaxe	Precio Price Prix
D0113	15 W	●	471	0,50 €	21,38 €
D0119	15 W	●	471	0,50 €	23,62 €
D0114	18 W	●	624	0,50 €	18,73 €
D0120	18 W	●	624	0,50 €	20,66 €
D0152	18 W	●	624	0,50 €	33,11 €
D0139	18 W	●	624	0,50 €	73,11 €
D0116	30 W	●	928	0,50 €	31,41 €
D0122	30 W	●	928	0,50 €	34,61 €
D0117	36 W	●	1.233	0,50 €	27,96 €
D0123	36 W	●	1.233	0,50 €	30,55 €
D0153	36 W	●	1.233	0,50 €	35,27 €
D0140	36 W	●	1.233	0,50 €	75,27 €
D0118	58 W	●	1.534	0,50 €	34,60 €
D0124	58 W	●	1.534	0,50 €	38,17 €
D0154	58 W	●	1.534	0,50 €	36,18 €
D0141	58 W	●	1.534	0,50 €	76,18 €

MODELOS ESPECIALES / SPECIAL MODELS / MODÈLES ESPECIAUX

CORRIENTE CONTINUA / DIRECT CURRENT / COURANT CONTINUE



Ref.	Potencia Watts Puissance	Equipo Equipment Ballast	Largo Length Longueur	Raee EU Recyclable tax Ecotaxe	Precio Price Prix
D0041	8 W	12 V	327	0,50 €	49,22 €
D0042	8 W	24 V	327	0,50 €	49,22 €
D0045	18 W	12 V	624	0,50 €	52,57 €
D0046	18 W	24 V	624	0,50 €	55,89 €

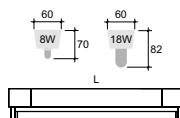
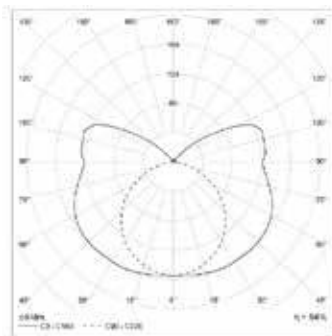

3 TUBOS FLUORESCENTES / 3 LAMPS / 3 LAMPES



Ref.	Potencia Watts Puissance	Equipo Equipment Ballast	Largo Length Longueur	Raee EU Recyclable tax Ecotaxe	Precio Price Prix
D0057	18 W	●	624	0,50 €	33,98 €
D0058	36 W	●	1.233	0,50 €	49,81 €

Bajo demanda se puede solicitar en cualquier potencia en T5 y T8

Also available in other watts in T5 or T8

Sur demande, pour d'autres puissances en T5 ou T8

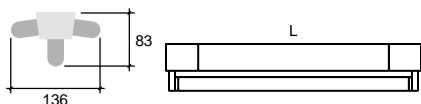

● Electrónica / Electronic / Électronique

4.1

Iluminación técnica / Regletas y Carriles

Technical lighting / Battens and Tracks

Éclairage technique / Réglettes et rails

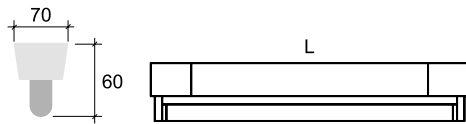

1 TUBO FLUORESCENTE
1 LAMP
1 LAMPE

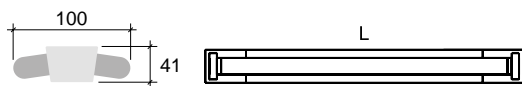

2 TUBOS FLUORESCENTES
2 LAMPS
2 LAMPES

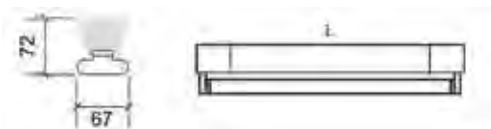

PORTALÁMPARAS DOBLE 2 TUBOS FLUORESCENTES
DOUBLE LAMPHOLDER 2 LAMPS
PORTE LAMPES DOUBLE 2 LAMPES



ES

Características generales

- Cuerpo luminaria: Chapa acero prelacada.
- Reflector (opcional): Aluminio brillante o chapa acero prelacada.
- Tapas finales: A.B.S.
- Temperatura de trabajo: De -15° C a +45° C.

EN

General characteristics

- Light fitting body: Lacquered steel.
- Reflector (optional): Glossy aluminium or lacquered steel.
- End caps: A.B.S.
- Working temperature: From -15° C to +45° C.

FR

Caractéristiques générales

- Corps du luminaire: Acier laqué.
- Réflecteur (optionnel): Aluminium brillant ou acier laqué.
- Embouts: A.B.S.
- Température d'utilisation: De -15° C à +45° C.



Ficha técnica
Technical data
Fiche technique

1 TUBO FLUORESCENTE / 1 LAMP / 1 LAMPE

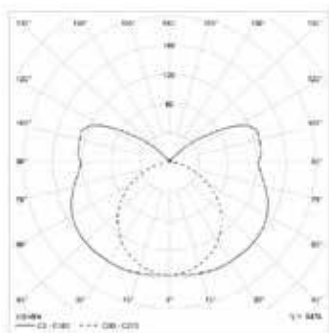

- Electrónica / *Electronic* / *Électronique*
- Regulable / *Dimmable* / *Gradable*

Ref.	Potencia Watts <i>Puissance</i>	Equipo Equipment <i>Ballast</i>	Largo Length <i>Longueur</i>	Raee EU Recyclable tax <i>Ecotaxe</i>	Precio Price <i>Prix</i>
Alta Eficacia / High Efficiency / Haute Efficacité					
D0101	14 W	●	587	0,25 €	26,71 €
D0067	14 W	●	587	0,25 €	66,71 €
D0102	21 W	●	887	0,50 €	29,93 €
D0068	21 W	●	887	0,50 €	69,93 €
D0103	28 W	●	1.187	0,50 €	31,31 €
D0069	28 W	●	1.187	0,50 €	71,31 €
D0104	35 W	●	1.487	0,50 €	31,98 €
D0071	35 W	●	1.487	0,50 €	71,98 €
Alto Rendimiento / High Output / Flux Élevé					
D0146	24 W	●	587	0,25 €	21,48 €
D0150	24 W	●	587	0,25 €	61,48 €
D0105	39 W	●	887	0,50 €	29,93 €
D0072	39 W	●	887	0,50 €	69,93 €
D0147	49 W	●	1.487	0,50 €	31,98 €
D0151	49 W	●	1.487	0,50 €	71,98 €
D0106	54 W	●	1.187	0,50 €	31,31 €
D0073	54 W	●	1.187	0,50 €	71,31 €
D0142	80 W	●	1.487	0,50 €	39,15 €
D0144	80 W	●	1.487	0,50 €	79,15 €

2 TUBOS FLUORESCENTES / 2 LAMPS / 2 LAMPES

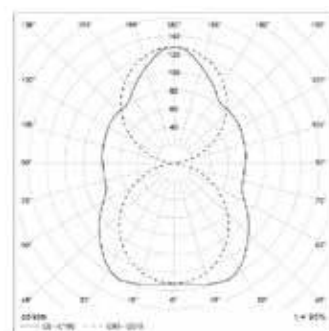

- Electrónica / *Electronic* / *Électronique*
- Regulable / *Dimmable* / *Gradable*

Ref.	Potencia Watts <i>Puissance</i>	Equipo Equipment <i>Ballast</i>	Largo Length <i>Longueur</i>	Raee EU Recyclable tax <i>Ecotaxe</i>	Precio Price <i>Prix</i>
Alta Eficacia / High Efficiency / Haute Efficacité					
D0107	14 W	●	587	0,25 €	32,23 €
D0078	14 W	●	587	0,25 €	72,23 €
D0108	21 W	●	887	0,50 €	33,59 €
D0079	21 W	●	887	0,50 €	73,59 €
D0109	28 W	●	1.187	0,50 €	34,04 €
D0080	28 W	●	1.187	0,50 €	74,04 €
D0110	35 W	●	1.487	0,50 €	34,85 €
D0095	35 W	●	1.487	0,50 €	74,85 €
Alto Rendimiento / High Output / Flux Élevé					
D0164	24 W	●	587	0,50 €	32,23 €
D0168	24 W	●	587	0,50 €	72,23 €
D0111	39 W	●	887	0,50 €	33,59 €
D0096	39 W	●	887	0,50 €	73,59 €
D0165	49 W	●	1.487	0,50 €	34,85 €
D0169	49 W	●	1.487	0,50 €	74,85 €
D0112	54 W	●	1.187	0,50 €	34,04 €
D0097	54 W	●	1.187	0,50 €	74,04 €
D0143	80 W	●	1.487	0,50 €	56,97 €
D0145	80 W	●	1.487	0,50 €	96,97 €

4.1

Iluminación técnica / Regletas y Carriles

Technical lighting / Battens and Tracks

Éclairage technique / Réglettes et rails

PORTALÁMPARAS DOBLE, 2 FLUORESCENTES

DOUBLE LAMPHOLDER 2 LAMPS

PORTE LAMPES DOUBLE, 2 LAMPES

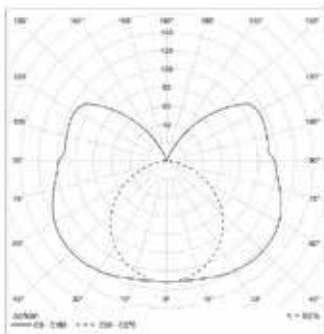

- Electrónica / Electronic / Électronique
- Regulable / Dimmable / Gradable

Ref.	Potencia Watts Puissance	Equipo Equipment Ballast	Largo Length Longueur	Raee EU Recyclable tax Ecotaxe	Precio Price Prix
Alta Eficacia / High Efficiency / Haute Efficacité					
D0261	14 W	●	587	0,25 €	36,27 €
D0262	14 W	●	587	0,25 €	76,27 €
D0263	21 W	●	887	0,50 €	37,17 €
D0264	21 W	●	887	0,50 €	77,17 €
D0265	28 W	●	1.187	0,50 €	37,84 €
D0266	28 W	●	1.187	0,50 €	77,84 €
D0267	35 W	●	1.487	0,50 €	38,58 €
D0268	35 W	●	1.487	0,50 €	78,58 €
Alto Rendimiento / High Output / Flux Élevé					
D0269	24 W	●	587	0,50 €	36,27 €
D0270	24 W	●	587	0,50 €	76,27 €
D0271	39 W	●	887	0,50 €	37,17 €
D0272	39 W	●	887	0,50 €	77,17 €
D0273	49 W	●	1.487	0,50 €	38,58 €
D0274	49 W	●	1.487	0,50 €	78,58 €
D0275	54 W	●	1.187	0,50 €	37,84 €
D0276	54 W	●	1.187	0,50 €	77,84 €
D0277	80 W	●	1.487	0,50 €	61,19 €
D0278	80 W	●	1.487	0,50 €	101,19 €

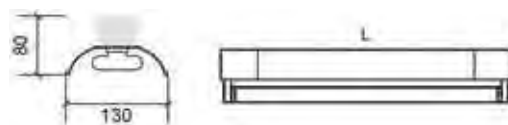

Con reflector de aluminio brillante

With glossy aluminium reflector

Avec réflecteur en aluminium brillant

4.1

Iluminación técnica / Regletas y Carriles

Technical lighting / Battens and Tracks

Éclairage technique / Réglettes et rails

DELTA CONEXIÓN RÁPIDA T5 Y T8 DELTA QUICK CONNECTION T5 AND T8 DELTA CONNEXION RAPIDE T5 ET T8



ES

Existen dos posibilidades de conectar varias luminarias Delta en línea: mediante un montaje con un interconector machohembra o mediante un montaje con cable de conexión de 2.5 mm² de sección que permite uniones en línea, con espacios, en ángulo, etc.

Para conocer el número máximo de luminarias que pueden ser conectadas en línea consultar al fabricante. Sistema disponible para luminarias electronicas de 1 tubo o de 2 tubos con portalamparas doble.

EN

The possibility exists of connecting several Delta light fittings with a special assembly, composed by an interconnector male-female and through a 2.5 mm² wide connection cable, that allows unions in line, in angle, etc.

To know the maximum number of light fixtures that can be connected in line, consult the manufacturer. System is available for 1 tube or 2 tubes double lampholder electronic light fittings.

FR

Il existe deux possibilités de connecter en ligne plusieurs luminaires Delta: au moyen d'un montage avec un interconnecteur mâle-femelle ou d'un montage avec un câble de connexion de 2.5 mm² de section qui permet des liaisons en ligne avec des espaces, en angles, etc.

Pour connaître le nombre maximum de luminaires pouvant être connectés en ligne, consulter le fabricant. Système disponible pour luminaires électroniques à 1 ou 2 tubes avec double douille.



Ejemplo de montaje con cable de conexión
Example of assembly with connection cable
Exemple d'assemblage de câbles



Posición final
Final position
Position finale

ACCESORIOS DELTA / DELTA ACCESSORIES / ACCESSOIRES DELTA

REF. D0187

27,69 €

**Incremento precio luminaria
conexión rápida**
Light fitting price increase
quick conection
Supplément prix de luminaire
connexion rapide

REF. D0188

3,57 €



Interconector macho-hembra
Male-female interconnector
Interconnecteur mâle-femmelle

REF. D0190

15,77 €



Cable de conexión
(maximo 1.500 mm)
Connection cable
(max. 1.500 mms.)
Connexion par câble
(max. 1,500 mm)



Bajo demanda, se puede fabricar para línea continua con manguera y un conector empotrado.

On request, we can manufacture for continuous line with a connector hose and flush.

Sur demande, nous pouvons fabriquer pour ligne continue avec un tuyau connecteur et rincer.

4.1

Iluminación técnica / Regletas y Carriles

Technical lighting / Battens and Tracks

Éclairage technique / Réglettes et rails

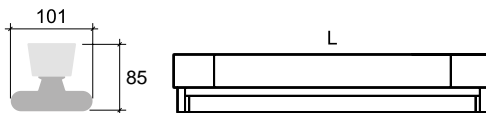
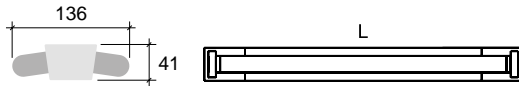
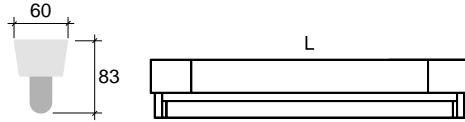
**ES****Características generales**

- Cuerpo luminaria: Chapa acero prelacada.
- Reflector (opcional): Aluminio brillante o chapa acero prelacada.
- Tapas finales: A.B.S.
- Temperatura de trabajo: Consultar al fabricante del tubo LED.

EN**General characteristics**

- Light fitting body: Lacquered steel.
- Reflector (optional): Glossy aluminium or lacquered steel.
- End caps: A.B.S.
- Working temperature: Ask the LED tube manufacturer.

FR**Caractéristiques générales**

- Corps du luminaire: Acier laqué.
- Réflecteur (optionnel): Aluminium brillant o acier laqué.
- Embouts: A.B.S.
- Température d'utilisation: Consultez au fabricant du tube LED.



Ficha técnica
Technical data
Fiche technique

1 TUBO LED / 1 LED TUBE / 1 TUBE LED



Ref.	Longitud Tubo Tube Length Longueur Tube	Longitud Luminaria Fitting Length Longueur Luminaire	Raee EU Recyclable tax Ecotaxe	Precio Price Prix
D0049L	600 mms.	624 mms.	0,25 €	17,02 €
D0055L	900 mms.	928 mms.	0,25 €	17,12 €
D0050L	1.200 mms.	1.233 mms.	0,25 €	17,66 €
D0051L	1.500 mms.	1.534 mms.	0,25 €	18,99 €

2 TUBOS LED / 2 LED TUBES / 2 TUBES LED



Ref.	Longitud Tubo Tube Length Longueur Tube	Longitud Luminaria Fitting Length Longueur Luminaire	Raee EU Recyclable tax Ecotaxe	Precio Price Prix
D0052L	600 mms.	624 mms.	0,25 €	18,34 €
D0056L	900 mms.	928 mms.	0,25 €	19,52 €
D0053L	1.200 mms.	1.233 mms.	0,25 €	21,02 €
D0054L	1.500 mms.	1.534 mms.	0,25 €	22,06 €

2 TUBOS LED / 2 LED TUBES / 2 TUBES LED



Ref.	Longitud Tubo Tube Length Longueur Tube	Longitud Luminaria Fitting Length Longueur Luminaire	Raee EU Recyclable tax Ecotaxe	Precio Price Prix
D0152L	600 mms.	624 mms.	0,25 €	21,11 €
D0156L	900 mms.	928 mms.	0,25 €	22,69 €
D0153L	1.200 mms.	1.233 mms.	0,25 €	23,27 €
D0154L	1.500 mms.	1.534 mms.	0,25 €	24,18 €

4.1

Iluminación técnica / Regletas y Carriles Technical lighting / Battens and Tracks Éclairage technique / Réglettes et rails

SIMÉTRICO 1 TUBO Y PORTALÁMPARAS DOBLE G13 SYMMETRICAL 1 LAMP AND DOUBLE LAMPHOLDER G13 SYMÉTRIQUE 1 LAMPE ET PORTE LAMPES DOUBLE G13

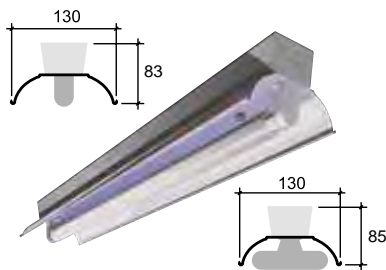

Ref.	Potencia Watts Puissance	Material	Largo Length Longueur	Precio Price Prix
T8				
DA400	15 W	Chapa / Steel / Acier	471	5,83 €
DA4A0	15 W	Aluminio / Aluminium	471	8,13 €
DA100	18 W	Chapa / Steel / Acier	624	3,92 €
DA1A0	18 W	Aluminio / Aluminium	624	5,71 €
DA600	30 W	Chapa / Steel / Acier	928	11,89 €
DA6A0	30 W	Aluminio / Aluminium	928	16,67 €
DA200	36 W	Chapa / Steel / Acier	1.233	7,83 €
DA2A0	36 W	Aluminio / Aluminium	1.233	11,13 €
DA300	58 W	Chapa / Steel / Acier	1.534	9,20 €
DA3A0	58 W	Aluminio / Aluminium	1.534	14,05 €
T5				
DE100	14-24 W	Chapa / Steel / Acier	587	5,87 €
DE1A0	14-24 W	Aluminio / Aluminium	587	9,36 €
DE200	21-39 W	Chapa / Steel / Acier	887	9,01 €
DE2A0	21-39 W	Aluminio / Aluminium	887	14,48 €
DE300	28-54 W	Chapa / Steel / Acier	1.187	12,34 €
DE3A0	28-54 W	Aluminio / Aluminium	1.187	16,95 €
DE400	35-49-80 W	Chapa / Steel / Acier	1.487	15,42 €
DE4A0	35-49-80 W	Aluminio / Aluminium	1.487	23,64 €

SIMÉTRICO 2 TUBOS SYMMETRICAL 2 LAMPS SYMÉTRIQUE 2 LAMPES

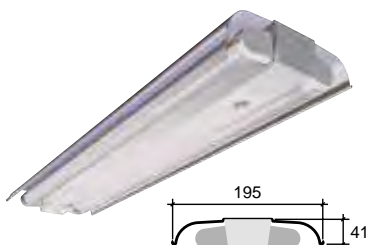

Ref.	Potencia Watts Puissance	Material	Largo Length Longueur	Precio Price Prix
T8				
DB400	15 W	Chapa / Steel / Acier	471	7,70 €
DB4A0	15 W	Aluminio / Aluminium	471	11,53 €
DB100	18 W	Chapa / Steel / Acier	624	5,08 €
DB1A0	18 W	Aluminio / Aluminium	624	7,22 €
DB600	30 W	Chapa / Steel / Acier	928	16,29 €
DB6A0	30 W	Aluminio / Aluminium	928	22,73 €
DB200	36 W	Chapa / Steel / Acier	1.233	9,74 €
DB2A0	36 W	Aluminio / Aluminium	1.233	14,93 €
DB300	58 W	Chapa / Steel / Acier	1.534	12,02 €
DB3A0	58 W	Aluminio / Aluminium	1.534	18,23 €
T5				
DF100	14-24 W	Chapa / Steel / Acier	587	8,16 €
DF1A0	14-24 W	Aluminio / Aluminium	587	12,26 €
DF200	21-39 W	Chapa / Steel / Acier	887	12,34 €
DF2A0	21-39 W	Aluminio / Aluminium	887	18,50 €
DF300	28-54 W	Chapa / Steel / Acier	1.187	16,34 €
DF3A0	28-54 W	Aluminio / Aluminium	1.187	24,87 €
DF400	35-49-80 W	Chapa / Steel / Acier	1.487	22,24 €
DF4A0	35-49-80 W	Aluminio / Aluminium	1.487	30,95 €

ASIMÉTRICO E
ASYMMETRICAL E
ASYMÉTRIQUE E

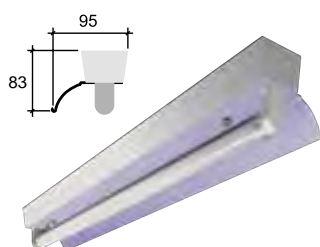

Ref.	Potencia Watts Puissance	Material	Largo Length Longueur	Precio Price Prix
T8				
DC400	15 W	Chapa / Steel / Acier	471	8,86 €
DC4A0	15 W	Aluminio / Aluminium	471	11,16 €
DC100	18 W	Chapa / Steel / Acier	624	5,35 €
DC1A0	18 W	Aluminio / Aluminium	624	7,18 €
DC600	30 W	Chapa / Steel / Acier	928	14,92 €
DC6A0	30 W	Aluminio / Aluminium	928	19,69 €
DC200	36 W	Chapa / Steel / Acier	1.233	9,30 €
DC2A0	36 W	Aluminio / Aluminium	1.233	12,60 €
DC300	58 W	Chapa / Steel / Acier	1.534	10,67 €
DC3A0	58 W	Aluminio / Aluminium	1.534	15,52 €
T5				
DG100	14-24 W	Chapa / Steel / Acier	587	8,45 €
DG1A0	14-24 W	Aluminio / Aluminium	587	11,93 €
DG200	21-39 W	Chapa / Steel / Acier	887	11,66 €
DG2A0	21-39 W	Aluminio / Aluminium	887	17,06 €
DG300	28-54 W	Chapa / Steel / Acier	1.187	14,91 €
DG3A0	28-54 W	Aluminio / Aluminium	1.187	19,53 €
DG400	35-49-80 W	Chapa / Steel / Acier	1.487	18,00 €
DG4A0	35-49-80 W	Aluminio / Aluminium	1.487	26,21 €

ASIMÉTRICO i
ASYMMETRICAL i
ASYMÉTRIQUE i

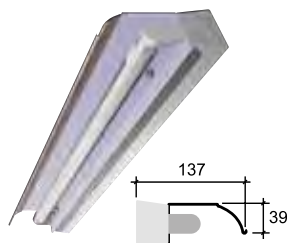

Ref.	Potencia Watts Puissance	Material	Largo Length Longueur	Precio Price Prix
T8				
DD400	15 W	Chapa / Steel / Acier	471	20,98 €
DD4A0	15 W	Aluminio / Aluminium	471	23,28 €
DD100	18 W	Chapa / Steel / Acier	624	11,23 €
DD1A0	18 W	Aluminio / Aluminium	624	13,06 €
DD600	30 W	Chapa / Steel / Acier	928	27,04 €
DD6A0	30 W	Aluminio / Aluminium	928	31,81 €
DD200	36 W	Chapa / Steel / Acier	1.233	15,18 €
DD2A0	36 W	Aluminio / Aluminium	1.233	18,49 €
DD300	58 W	Chapa / Steel / Acier	1.534	16,56 €
DD3A0	58 W	Aluminio / Aluminium	1.534	21,41 €
T5				
DH100	14-24 W	Chapa / Steel / Acier	587	18,75 €
DH1A0	14-24 W	Aluminio / Aluminium	587	22,23 €
DH200	21-39 W	Chapa / Steel / Acier	887	21,96 €
DH2A0	21-39 W	Aluminio / Aluminium	887	27,36 €
DH300	28-54 W	Chapa / Steel / Acier	1.187	25,21 €
DH3A0	28-54 W	Aluminio / Aluminium	1.187	29,83 €
DH400	35-49-80 W	Chapa / Steel / Acier	1.487	28,30 €
DH4A0	35-49-80 W	Aluminio / Aluminium	1.487	36,51 €

4.1

Iluminación técnica / Regletas y Carriles
Technical lighting / Battens and Tracks
Éclairage technique / Réglettes et rails

Carril Track Rail	Perfil Profile Profile	T8			T5		Tapa final End cap Embout	Empalme Track joint Pièce de liason
		Carril / Track / Rail 3070 MMS. 2 X 58	Carril / Track / Rail 3700 MMS. 3 X 36	Carril / Track / Rail 4620 MMS. 3 X 58	Carril / Track / Rail 3000 MMS. 2 X 35/49	Carril / Track / Rail 3598 MMS. 3 X 28/54		
CHAPA ACERO / LACQUERED STEEL / ACIER LAQUÉ 25 X 67,2 MMS.		D0059 18,50 €	D0060 22,09 €	D0174 26,86 €	D0039 17,94 €	D0125 21,13 €	D0034 0,73 €	D0064 2,75 €
ALUMINIO / ALUMINIUM / ALUMINIUM 22,5 X 64 MMS.		D0061 37,32 €	D0062 44,96 €	N/D N/A	D0040 37,14 €	D0132 44,64 €	D0065 0,63 €	D0064 2,75 €
ALUMINIO / ALUMINIUM / ALUMINIUM 26,5 X 64 MMS.		D0084 44,08 €	D0085 53,14 €	N/D N/A	D0055 44,08 €	D0077 53,14 €	D0081 0,39 €	D0064 2,75 €
ALUMINIO / ALUMINIUM / ALUMINIUM 41,5 X 64 MMS.		D0086 47,49 €	D0087 56,98 €	N/D N/A	D0056 47,20 €	D0100 56,98 €	D0082 0,41 €	D0083 3,24 €

Sujeción a carril
Fastener for track
Fixation au RAIL
REF. D0063 0,64 €

Empalme de carril
Track joint
Pièce de liason

Tapa final
End cap
Embout

Tapa ciega de aluminio
Track cap on aluminium
Couvercle en aluminium
REF. D0066 9,64 €

Tapa ciega de A.B.S.
A.B.S. track cap
Couvercle en A.B.S.
REF. D0070 4,04 €

Metro lineal
Lineal meter
Mètre linéaire

- Difusor / Diffuser / Diffuseur**
- 15W REF. D0026 4,72 €
 - 18W REF. D0027 4,72 €
 - 30W REF. D0029 9,74 €
 - 36W REF. D0030 9,74 €
 - 58W REF. D0031 12,20 €

REF. D0191 5,32 €

Fijación carril a perfil techo desmontable
Track fastener to removable ceiling profile
Fixation de carril au profil du
plafond démontable

REF. D0025 0,22 €

Tapa final difusor
End cap for diffuser
Embout diffuseur

REF. D0074 1,53 €

Pieza alineación reflectores
Reflector alignment piece
Pièce d'alignement des réflecteurs

Suspensiones / Suspensions / Suspensions



	Carril / Track / Rail 22,5 - 25		Carril / Track / Rail 26,5 - 41,5	
	Ref.	€	Ref.	€
Tija 95 mm / Stem 95 mm / Tige 95 mm	D0156	3,91 €	D0126	6,36 €
Tija 250 mm / Stem 250 mm / Tige 250 mm	D0157	6,54 €	D0127	9,34 €
Tija 500 mm / Stem 500 mm / Tige 500 mm	D0158	9,45 €	D0128	12,25 €
Tija 1000 mm / Stem 1000 mm / Tige 1000 mm	D0159	13,08 €	D0129	15,89 €
Tija 1500 mm / Stem 1500 mm / Tige 1500 mm	D0160	21,92 €	D0130	24,72 €
Con cable de acero 1900 mm / With steel cable 1900 mm Avec câble en acier 1900 mm	D0161	6,98 €	D0131	9,60 €



MINIDELTA

Bodegas Enate, Huesca, España



Enate Wineries, Huesca, Spain

Caves Enate, Huesca, Espagne



4.1

Iluminación técnica / Regletas y Carriles
Technical lighting / Battens and Tracks
Éclairage technique / Réglettes et rails

CARRIL 5 HILOS / 5 WIRES TRACK / RAIL SUPPORT 5 FILS

Carril Track Rail	Perfil Profile Profile	T8						T5			
		Carril / Track Rail 3070 MMS. 2 X 58 W		Carril / Track Rail 3700 MMS. 3 X 36 W		Carril / Track Rail 4620 MMS. 3 X 58 W		Carril / Track Rail 3000 MMS. 2 X35/49/80/120W		Carril / Track Rail 3598 MMS. 3 X28/54/95 W	
		Ref.	Precio Price Prix	Ref.	Precio Price Prix	Ref.	Precio Price Prix	Ref.	Precio Price Prix	Ref.	Precio Price Prix
25 X 67,2 MMS.		D0043	67,04 €	D0047	77,40 €	D0172	95,41 €	D0179	67,04 €	D0180	77,40 €
ALUMINIO / ALUMINIUM / ALUMINIUM 22,5 X 64 MMS.		D0088	95,96 €	D0098	113,75 €	N/D N/A	N/D N/A	D0183	96,13	D0184	113,75 €

CARRIL 7 HILOS / 7 WIRES TRACK / RAIL SUPPORT 7 FILS

Carril Track Rail	Perfil Profile Profile	T8						T5			
		Carril / Track Rail 3070 MMS. 2 X 58 W		Carril / Track Rail 3070 MMS. 3 X 36 W		Carril / Track Rail 4620 MMS. 3 X 58 W		Carril / Track Rail 3000 MMS. 2 X35/49/80/120W		Carril / Track Rail 3598 MMS. 3 X28/54/95 W	
		Ref.	Precio Price Prix	Ref.	Precio Price Prix	Ref.	Precio Price Prix	Ref.	Precio Price Prix	Ref.	Precio Price Prix
CHAPA ACERO / LACQUERED STEEL ACIER LAQUÉ 25 X 67,2 MMS.		D0044	75,27 €	D0048	87,48 €	D0173	104,98 €	D0181	75,27 €	D0182	87,48 €
ALUMINIO / ALUMINIUM / ALUMINIUM 22,5 X 64 MMS.		D0089	104,28 €	D0099	123,80 €	N/D N/A	N/D N/A	D0185	104,28 €	D0186	123,80 €

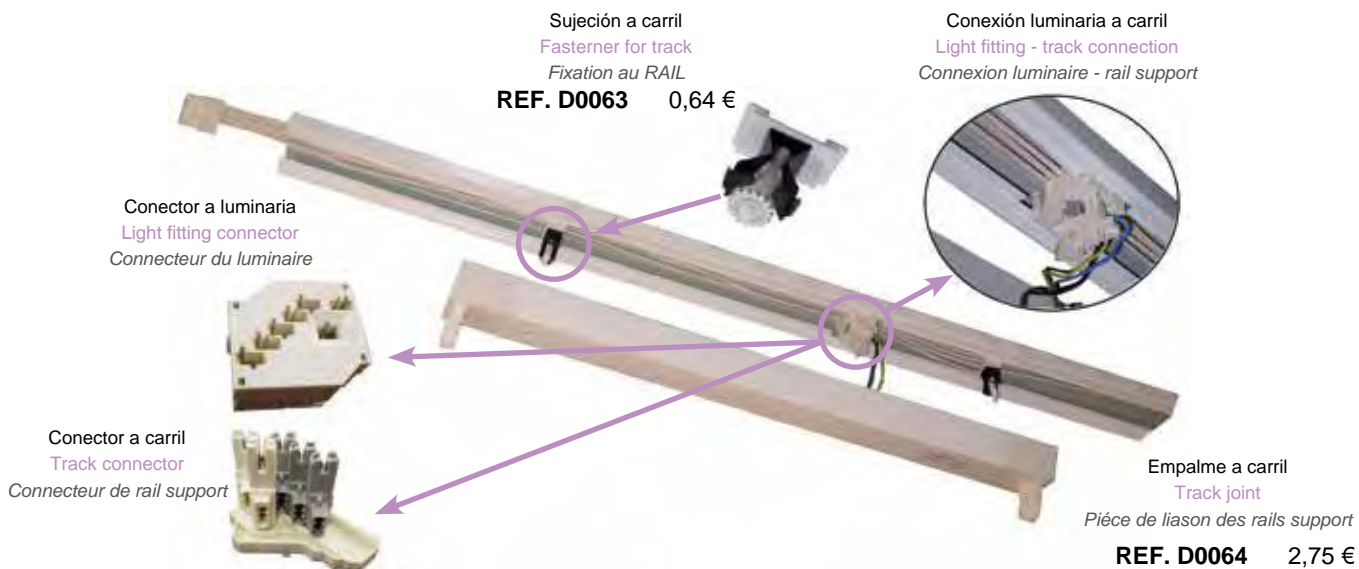

Suplemento de precio / Price increase / Aumentation de prix	Ref.	Precio / Price / Prix
3 polos / 3 poles / 3 pôles (L, N, T)	D0036	6,74 €
5 polos / 5 poles / 5 pôles (L, N, T,+,-)	D0037	9,74 €
7 polos / 7 poles / 7 pôles (3xL, N, T,+,-)	D0175	11,97 €

Conexión entre carriles
Connection between tracks
Connecteur de RAIL



ACCESORIOS / ACCESSORIES / ACCESSOIRES

REF. D0065

0,63 €



Tapa final de carril aluminio
22,5x64
End cap for track aluminium
22,5x64
Embout final de rail support
aluminium 22,5x64

REF. D0070

4,04 €



Tapa ciega de A.B.S. Metro lineal
Track cap on A.B.S. Lineal meter
Couvercle en A.B.S. Mètre linéaire

REF. D0066

9,64 €

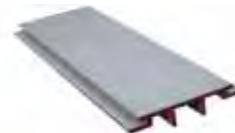

Tapa ciega de aluminio
Metro lineal
Aluminium track cap Lineal meter
Couvercle en aluminium
Mètre linéaire

REF. D0034

0,73 €



Tapa final de carril de chapa
25x64
End cap for lacquered steel track
25x64
Embout final du rail support
d'acier 25x64

REF. D0191

5,32 €



Fijación carril a perfil techo
desmontable
Track fastener to removable
ceiling profile
Fixation de carril au profil du
plafond démontable

(*) No disponible para Mini Delta
For Mini Delta model not available
Non disponible pour Mini Delta
Para luminarias de 2 tubos con reflector
debe usarse el portalámparas G13 doble.
For 2 tubes light fitting with reflector have
to use double G13 lampholder.
Pour les luminaires avec 2 lampes et
réflecteur doit être utilisé porte lampes
double G13.

4.1

Iluminación técnica / Regletas y Carriles

Technical lighting / Battens and Tracks

Éclairage technique / Réglettes et rails

ES

Características generales

- Cuerpo luminaria: Chapa acero prelacada.
- Reflector (opcional): Aluminio brillante o chapa acero prelacada.
- Tapas finales: A.B.S.
- Temperatura de trabajo: De -15° C a +45° C.

EN

General characteristics

- Light fitting body: Lacquered steel.
- Reflector (optional): Glossy aluminium or lacquered steel.
- End caps: A.B.S.
- Working temperature: From -15° C to +45° C.

FR

Caractéristiques générales

- Corps du luminaire: Acier laqué.
- Réflecteur (optionnel): Aluminium brillant o acier laqué.
- Embouts: A.B.S.
- Température d'utilisation: De -15° C à +45° C.

1 TUBO FLUORESCENTE / 1 LAMP / 1 LAMPE

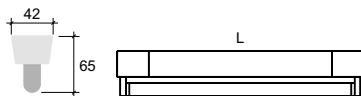
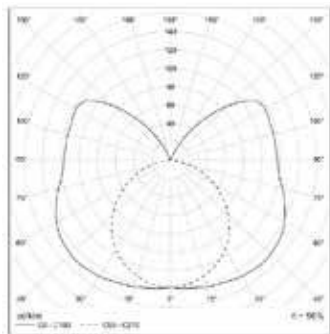

Ref.	Potencia Watts Puissance	Equipo Equipment Ballast	Largo Length Longueur	Raee EU Recyclable tax Ecotaxe	Precio Price Prix
Alta Eficacia / High Efficiency / Haute Efficacité					
D0701	14 W	●	598	0,25 €	25,77 €
D0712	14 W	●	598	0,25 €	65,77 €
D0702	21 W	●	898	0,25 €	26,20 €
D0713	21 W	●	898	0,25 €	66,20 €
D0703	28 W	●	1.198	0,50 €	31,36 €
D0714	28 W	●	1.198	0,50 €	71,36 €
D0704	35 W	●	1.498	0,50 €	31,65 €
D0715	35 W	●	1.498	0,50 €	71,65 €
Alto Rendimiento / High Output / Flux Élevé					
D0705	24 W	●	598	0,25 €	21,45 €
D0716	24 W	●	598	0,25 €	61,45 €
D0706	39 W	●	898	0,50 €	31,00 €
D0717	39 W	●	898	0,50 €	71,00 €
D0707	49 W	●	1.498	0,50 €	33,00 €
D0718	49 W	●	1.498	0,50 €	73,00 €
D0708	54 W	●	1.198	0,50 €	33,69 €
D0719	54 W	●	1.198	0,50 €	73,69 €
D0709	80 W	●	1.498	0,50 €	35,29 €
D0720	80 W	●	1.498	0,50 €	75,29 €

● Electrónica / Electronic / Électronique

● Regulable / Dimmable / Gradable



Ficha técnica
Technical data
Fiche technique

2 TUBOS FLUORESCENTES / 2 LAMPS / 2 LAMPES

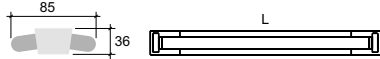
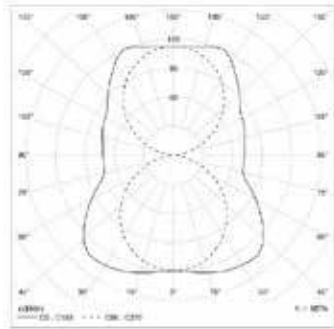

- Electrónica / Electronic / Électronique
- Regulable / Dimmable / Gradable

Ref.	Potencia Watts Puissance	Equipo Equipment Ballast	Largo Length Longueur	Raee EU Recyclable tax Ecotaxe	Precio Price Prix
Alta Eficacia / High Efficiency / Haute Efficacité					
D0721	14 W	●	598	0,25 €	31,52 €
D0729	14 W	●	598	0,25 €	71,52 €
D0722	21 W	●	898	0,25 €	33,21 €
D0730	21 W	●	898	0,25 €	73,21 €
D0723	28 W	●	1.198	0,50 €	33,79 €
D0731	28 W	●	1.198	0,50 €	73,79 €
D0724	35 W	●	1.498	0,50 €	34,28 €
D0732	35 W	●	1.498	0,50 €	74,28 €
Alto Rendimiento / High Output / Flux Élevé					
D0725	24 W	●	598	0,25 €	33,35 €
D0733	24 W	●	598	0,25 €	73,35 €
D0726	39 W	●	898	0,50 €	32,69 €
D0734	39 W	●	898	0,50 €	62,69 €
D0753	49 W	●	1.498	0,50 €	34,12 €
D0754	49 W	●	1.498	0,50 €	74,12 €
D0727	54 W	●	1.198	0,50 €	33,76 €
D0735	54 W	●	1.198	0,50 €	73,76 €
D0728	80 W	●	1.498	0,50 €	56,41 €
D0736	80 W	●	1.498	0,50 €	96,41 €

PORTALÁMPARAS DOBLE, 2 FLUORESCENTES DOUBLE LAMPHOLDER 2 LAMPS PORTE LAMPES DOUBLE, 2 LAMPES



- Electrónica / Electronic / Électronique
- Regulable / Dimmable / Gradable

Ref.	Potencia Watts Puissance	Equipo Equipment Ballast	Largo Length Longueur	Raee EU Recyclable tax Ecotaxe	Precio Price Prix
Alta Eficacia / High Efficiency / Haute Efficacité					
D0737	14 W	●	598	0,25 €	32,22 €
D0745	14 W	●	598	0,25 €	72,22 €
D0738	21 W	●	898	0,25 €	33,90 €
D0746	21 W	●	898	0,25 €	73,90 €
D0739	28 W	●	1.198	0,50 €	34,48 €
D0747	28 W	●	1.198	0,50 €	74,48 €
D0740	35 W	●	1.498	0,50 €	34,97 €
D0748	35 W	●	1.498	0,50 €	74,97 €
Alto Rendimiento / High Output / Flux Élevé					
D0741	24 W	●	598	0,25 €	32,30 €
D0749	24 W	●	598	0,25 €	72,30 €
D0742	39 W	●	898	0,50 €	33,38 €
D0750	39 W	●	898	0,50 €	73,38 €
D0755	49 W	●	1.498	0,50 €	34,95 €
D0756	49 W	●	1.498	0,50 €	74,95 €
D0743	54 W	●	1.198	0,50 €	35,50 €
D0751	54 W	●	1.198	0,50 €	75,50 €

4.1

Iluminación técnica / Regletas y Carriles

Technical lighting / Battens and Tracks

Éclairage technique / Réglettes et rails



ES

Características generales

- Cuerpo luminaria: Chapa acero prelacada.
- Reflector (opcional): Aluminio brillante o chapa acero prelacada.
- Tapas finales: A.B.S.
- Temperatura de trabajo: De -15° C a +45° C.

EN

General characteristics

- Light fitting body: Lacquered steel.
- Reflector (optional): Glossy aluminium or lacquered steel.
- End caps: A.B.S.
- Working temperature: From -15° C to +45° C.

FR

Caractéristiques générales

- Corps du luminaire: Acier laqué.
- Réflecteur (optionnel): Aluminium brillant o acier laqué.
- Embouts: A.B.S.
- Température d'utilisation: De -15° C à +45° C.

1 TUBO FLUORESCENTE / 1 LAMP / 1 LAMPE

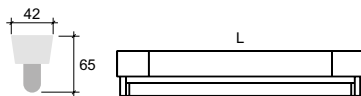
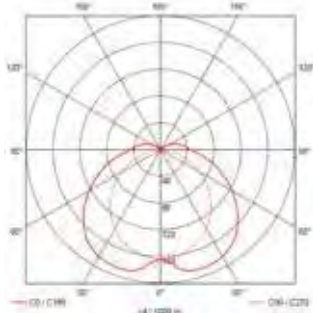

- Electrónica / Electronic / Électronique
- Regulable / Dimmable / Gradable

Ref.	Potencia Watts Puissance	Equipo Equipment Ballast	Largo Length Longueur	Raee EU Recyclable tax Ecotaxe	Precio Price Prix
Alta Eficacia / High Efficiency / Haute Efficacité					
D0771	18 W	●	635	0,25 €	28,49 €
D0772	18 W	●	635	0,25 €	68,49 €
D0773	36 W	●	1.244	0,50 €	29,05 €
D0774	36 W	●	1.244	0,50 €	69,05 €
D0775	58 W	●	1.545	0,50 €	30,31 €
D0776	58 W	●	1.545	0,50 €	70,31 €



Ficha técnica
Technical data
Fiche technique

4.1

Iluminación técnica / Regletas y Carriles

Technical lighting / Battens and Tracks

Éclairage technique / Réglettes et rails



ES

Características generales

- Reflector (opcional): Aluminio brillante o chapa acero prelacada.
- Tapas finales: A.B.S.
- Temperatura de trabajo: Consultar al fabricante del tubo LED.

EN

General characteristics

- Light fitting body: Lacquered steel.
- Reflector (optional): Glossy aluminium or lacquered steel.
- End caps: A.B.S.
- Working temperature: Ask the LED tube manufacturer.

FR

Caractéristiques générales

- Corps du luminaire: Acier laqué.
- Réflecteur (optionnel): Aluminium brillant o acier laqué.
- Embouts: A.B.S.
- Température d'utilisation: Consultez au fabricant du tube LED.

1 TUBO LED / 1 LED TUBE / 1 TUBE LED

Ref.	Longitud Tubo Tube Length Longueur Tube	Longitud Luminaria Fitting Length Longueur Luminaire	Raee EU Recyclable tax Ecotaxe	Precio Price Prix
D0771L	600 mms.	624 mms.	0,25 €	16,49 €
D0777L	900 mms.	928 mms.	0,25 €	16,77 €
D0773L	1.200 mms.	1.233 mms.	0,25 €	17,05 €
D0775L	1.500 mms.	1.534 mms.	0,25 €	18,31 €

4.1

Iluminación técnica / Regletas y Carriles
Technical lighting / Battens and Tracks
Éclairage technique / Réglettes et rails

SIMÉTRICO 1 TUBO / SYMMETRICAL 1 LAMP / SYMÉTRIQUE 1 LAMPE



Ref.	Potencia Watts Puissance	Material Material Matériel	Largo Length Longueur	Precio Price Prix
DK100	14-24 W	Chapa / Steel / Acier	598	5,06 €
DK1A0	14-24 W	Aluminio / Aluminium	598	7,23 €
DK200	21-39 W	Chapa / Steel / Acier	898	7,52 €
DK2A0	21-39 W	Aluminio / Aluminium	898	10,77 €
DK300	28-54 W	Chapa / Steel / Acier	1.198	10,13 €
DK3A0	28-54 W	Aluminio / Aluminium	1.198	14,71 €
DK400	35-49-80 W	Chapa / Steel / Acier	1.498	12,61 €
DK4A0	35-49-80 W	Aluminio / Aluminium	1.498	18,25 €

SIMÉTRICO 2 TUBOS / SYMMETRICAL 2 LAMPS / SYMÉTRIQUE 2 LAMPES



Ref.	Potencia Watts Puissance	Material Material Matériel	Largo Length Longueur	Precio Price Prix
DJ100	14-24 W	Chapa / Steel / Acier	598	6,46 €
DJ1A0	14-24 W	Aluminio / Aluminium	598	9,04 €
DJ200	21-39 W	Chapa / Steel / Acier	898	9,66 €
DJ2A0	21-39 W	Aluminio / Aluminium	898	13,66 €
DJ300	28-54 W	Chapa / Steel / Acier	1.198	13,20 €
DJ3A0	28-54 W	Aluminio / Aluminium	1.198	18,40 €
DJ400	35-49-80 W	Chapa / Steel / Acier	1.498	16,42 €
DJ4A0	35-49-80 W	Aluminio / Aluminium	1.498	23,01 €

ASIMÉTRICO E / ASYMMETRICAL E / ASYMÉTRIQUE E



Ref.	Potencia Watts Puissance	Material Material Matériel	Largo Length Longueur	Precio Price Prix
DL100	14-24 W	Chapa / Steel / Acier	598	8,21 €
DL1A0	14-24 W	Aluminio / Aluminium	598	10,38 €
DL200	21-39 W	Chapa / Steel / Acier	898	10,67 €
DL2A0	21-39 W	Aluminio / Aluminium	898	13,92 €
DL300	28-54 W	Chapa / Steel / Acier	1.198	13,28 €
DL3A0	28-54 W	Aluminio / Aluminium	1.198	17,86 €
DL400	35-49-80 W	Chapa / Steel / Acier	1.498	15,76 €
DL4A0	35-49-80 W	Aluminio / Aluminium	1.498	21,40 €

ASIMÉTRICO i / ASYMMETRICAL i / ASYMÉTRIQUE i







Ref.	Potencia Watts Puissance	Material Material Matériel	Largo Length Longueur	Precio Price Prix
DM100	14-24 W	Chapa / Steel / Acier	598	17,66 €
DM1A0	14-24 W	Aluminio / Aluminium	598	19,83 €
DM200	21-39 W	Chapa / Steel / Acier	898	20,20 €
DM2A0	21-39 W	Aluminio / Aluminium	898	23,37 €
DM300	28-54 W	Chapa / Steel / Acier	1.198	22,73 €
DM3A0	28-54 W	Aluminio / Aluminium	1.198	27,31 €
DM400	35-49-80 W	Chapa / Steel / Acier	1.498	25,21 €
DM4A0	35-49-80 W	Aluminio / Aluminium	1.498	30,85 €

CARRILES Y ACCESORIOS

TRACKS AND ACCESSORIES

CHEMINS LIMINEUX ET ACCESSOIRES

Carril Track Rail	Perfil Profile Profile	Carril / Track / Rail 3000 MMS. 2 X 35/49W		Carril / Track / Rail 3598 MMS. 3 X 28/54W		Tapa final End cap Embout		Empalme Track joint Pièce de liaison	
		Ref.	Precio Price Prix	Ref.	Precio Price Prix	Ref.	Precio Price Prix	Ref.	Precio Price Prix
CHAPA ACERO / LACQUERED STEEL / ACIER LAQUÉ 25 X 67,2 MMS.		D0039	17,94 €	D0125	21,13 €	D0034	0,73 €	D0064	2,75 €
ALUMINIO / ALUMINIUM / ALUMINIUM 22,5 X 64 MMS.		D0040	37,14 €	D0132	44,64 €	D0065	0,63 €	D0064	2,75 €
ALUMINIO / ALUMINIUM / ALUMINIUM 26,5 X 64 MMS.		D0055	44,08 €	D0077	53,14 €	D0081	0,39 €	D0064	2,75 €
ALUMINIO / ALUMINIUM / ALUMINIUM 41,5 X 64 MMS.		D0056	47,21 €	D0100	56,98 €	D0082	0,41 €	D0083	3,24 €

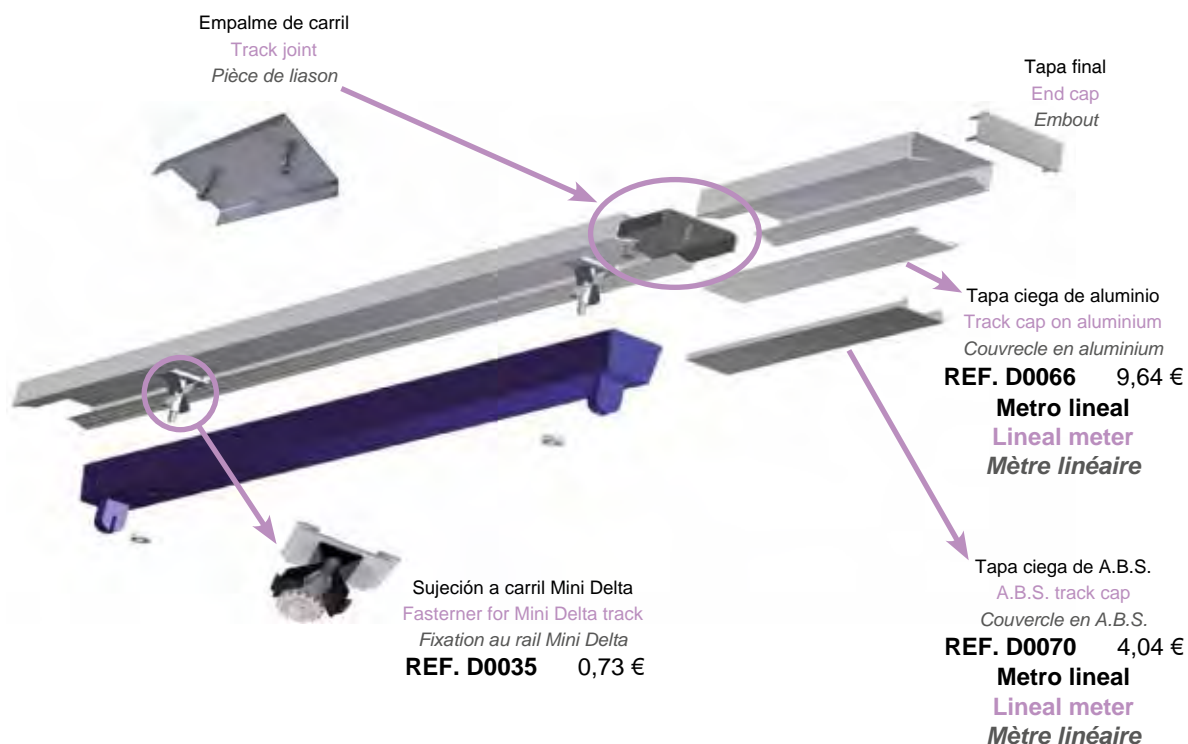

REF. D0191



Fijación carril a perfil techo desmontable
Track fastener to removable ceiling profile
Fixation de carril au profil du
plafond démontable

5,32 €

REF. D0074



Pieza alineación reflectores
Reflector alignment piece
Pièce d'alignement des réflecteurs

1,53 €

Suspensiones / Suspensions / Suspensions



Tija 95 mm / Stem 95 mm / Tige 95 mm

Tija 250 mm / Stem 250 mm / Tige 250 mm

Tija 500 mm / Stem 500 mm / Tige 500 mm

Tija 1000 mm / Stem 1000 mm / Tige 1000 mm

Tija 1500 mm / Stem 1500 mm / Tige 1500 mm

Con cable de acero 1900 mm / With steel cable 1900 mm Avec câble en acier 1900 mm

Carril / Track / Rail 22,5 - 25		Carril / Track / Rail 26,5 - 41,5	
Ref.	€	Ref.	€
D0156	3,91 €	D0126	6,36 €
D0157	6,54 €	D0127	9,34 €
D0158	9,45 €	D0128	12,25 €
D0159	13,08 €	D0129	15,89 €
D0160	21,92 €	D0130	24,72 €
D0161	6,98 €	D0131	9,60 €

Ref.

€

Ref.

€

D0156

3,91 €

D0126

6,36 €

D0157

6,54 €

D0127

9,34 €

D0158

9,45 €

D0128

12,25 €

D0159

13,08 €

D0129

15,89 €

D0160

21,92 €

D0130

24,72 €

D0161

6,98 €

D0131

9,60 €

4.1

Iluminación técnica / Regletas y Carriles
Technical lighting / Battens and Tracks
Éclairage technique / Réglettes et rails

ES

Se pueden conectar varias luminarias Mini Delta en línea mediante un montaje con un interconector macho-hembra.

EN

It exists the possibility of connecting several Mini Delta light fittings with a special assembly, composed by an interconnector male-female.

FR

Il existe le possibilité de connecter en ligne plusieurs luminaires Mini Delta au moyen d'un montage avec un interconnecteur mâle-femelle.



Posición inicial
Initial position
Position initiale

Interconector macho-hembra
Interconnector male-female
Interconnecteur mâle-femelle

Accesorios / Accessories / Accessoires

	Ref.	Precio Price Prix
Incremento precio luminaria conexión rápida Light fitting price increase quick connection Supplément prix de luminaire connexion rapide	D0781	22,11 €
Interconector macho-hembra Male-female interconnector Interconnecteur mâle-femelle	D0782	3,92 €

4.1

Iluminación técnica / Regletas y Carriles
Technical lighting / Battens and Tracks
Éclairage technique / Réglettes et rails

Carril Track Rail	Perfil Profile Profile	Carril / Track / Rail 3000 MMS. 2 X 35/49W		Carril / Track / Rail 3598 MMS. 3 X 28/54W	
		Ref.	Precio / Price / Prix	Ref.	Precio / Price / Prix
25 X 67,2 MMS.		D0783	90,31 €	D0784	104,29 €



Suplemento de precio / Price increase / Aumentation de prix	Ref.	Precio / Price / Prix
3 polos / 3 poles / 3 pôles (L, N, T)	D0785	3,19 €
5 polos / 5 poles / 5 pôles (L, N, T,+, -)	D0786	3,79 €

ACCESORIOS / ACCESSORIES / ACCESSOIRES

REF. D0070

4,04 €



Tapa ciega de A.B.S. Metro lineal
Track cap on A.B.S. Linear meter
Couvercle en A.B.S. Mètre linéaire

REF. D0034

0,73 €



Tapa final de carril de chapa 25x64
End cap for lacquered steel track 25x64
Embout final du rail support d'acier 25x64

REF. D0064

2,75 €



Empalme a carril
Track joint
Pièce de liaison des rails support

REF. D0191

5,32 €



Fijación carril a perfil techo desmontable
Track fastener to removable ceiling profile
Fixation de carril au profil du plafond démontable

Para luminarias de 2 tubos con reflector debe usarse el portalámparas G5 doble
For 2 tubes light fitting with reflector have to use double G5 lampholder
Pour les luminaires avec 2 lampes et réflecteur doit être utilisé porte lampes double G5

4.2

Iluminación técnica / Iluminación comercial

Technical lighting / Commercial lighting

Éclairage technique / Éclairage commercial



ES

Una luminaria industrial con toques decorativos. Con posibilidad de hacer líneas continuas con los accesorios, carriles, etc., del modelo Delta. Podremos encontrarla en colegios, tiendas, etc.

Características generales

- Cuerpo luminaria: Chapa acero prelacada.
- Reflector: Aluminio brillante / opcional: chapa prelacada.
- Lama: A.B.S.
- Tapas finales: A.B.S.
- Temperatura de trabajo: De -15° C a +45° C.

EN

An industrial luminaire with decorative touches. It offers the possibility of forming continuous lines with accessories, tracks, etc., for Delta model. Can be found in schools, shops, etc.

General characteristics

- Light fitting body: Lacquered steel.
- Reflector: Glossy aluminum / optional: laquered steel.
- Louvre: A.B.S.
- End caps: A.B.S.
- Working temperature: From -15° C to +45° C.

FR

Un luminaire industriel avec des touches décoratives. Possibilité de faire des installations en ligne continues avec les accessoires, rails, etc. du modèle Delta. On peut retrouver ce modèle dans les écoles, magasin, etc.

Caractéristiques générales

- Corps du luminaire: Acier laqué.
- Réflecteur: Aluminium brillant / optionnel: acier laqué blanc.
- Grille: A.B.S.
- Embouts: A.B.S.
- Température d'utilisation: De -15° C à +45° C.

Accesorios / Accessories / Accessoires

Detalle de montaje
Assembly detail
Détail du montage

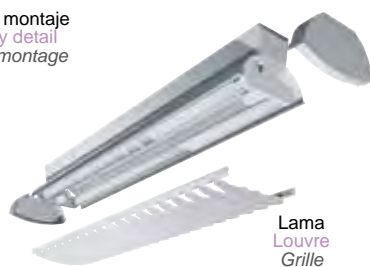

Lama
Louvre
Grille

Tapa final
End cap
Embout

Ref.	Precio Price Prix
D0325	1,10 €



Ficha técnica
Technical data
Fiche technique



DISPONIBLE PARA LED
CONSULTAR PRECIO

T8			T5		
Mod.	Ref.	Precio Price Prix	Mod.	Ref.	Precio Price Prix
15 W	D0326	4,41 €	14-24 W	D0332	4,41 €
18 W	D0327	4,41 €	21-39 W	D0333	8,81 €
30 W	D0329	8,81 €	28-54 W	D0334	8,81 €
36 W	D0330	8,81 €	35-80 W	D0335	11,01 €
58 W	D0331	11,01 €			

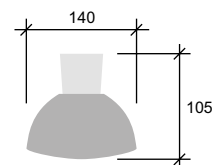

La luminaria incluye reflector, tapas finales y lama
Light fitting includes reflector, end caps and louvre
Luminaire comprend réflecteur, embouts et diffuseur

1 TUBO FLUORESCENTE / 1 LAMP / 1 LAMPE

G 13
T8

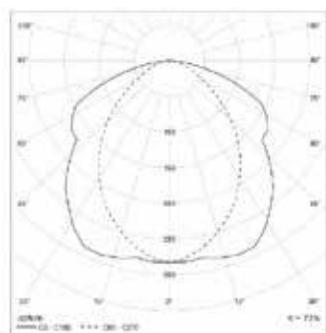

- Bajo factor / Low factor / Non-compensé
- Alto factor / High factor / Compensé
- Electrónica / Electronic / Électronique
- Regulable / Dimmable / Gradable

Ref.	Potencia Watts Puissance	Equipo Equipment Ballast	Largo Length Longueur	Raee EU Recyclable tax Ecotaxe	Precio Price Prix
T8					
D0301	15 W	●	471	0,50 €	25,80 €
D0307	15 W	●	471	0,50 €	28,24 €
D0336	15 W	●	471	0,50 €	35,26 €
D0302	18 W	●	624	0,50 €	28,89 €
D0308	18 W	●	624	0,50 €	31,33 €
D0349	18 W	●	624	0,50 €	47,32 €
D0433	18 W	●	624	0,50 €	87,32 €
D0304	30 W	●	928	0,50 €	36,55 €
D0310	30 W	●	928	0,50 €	38,97 €
D0337	30 W	●	928	0,50 €	50,61 €
D0305	36 W	●	1.233	0,50 €	40,67 €
D0311	36 W	●	1.233	0,50 €	43,11 €
D0350	36 W	●	1.233	0,50 €	56,95 €
D0434	36 W	●	1.233	0,50 €	96,95 €
D0306	58 W	●	1.534	0,50 €	49,98 €
D0312	58 W	●	1.534	0,50 €	52,77 €
D0351	58 W	●	1.534	0,50 €	63,13 €
D0435	58 W	●	1.534	0,50 €	103,13 €

2 TUBOS FLUORESCENTES / 2 LAMPS / 2 LAMPES

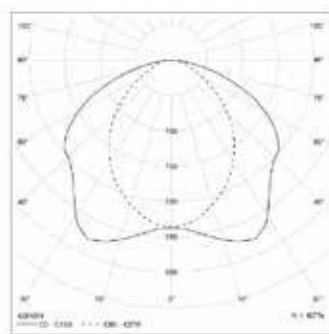

- Bajo factor / Low factor / Non-compensé
- Alto factor / High factor / Compensé
- Electrónica / Electronic / Électronique
- Regulable / Dimmable / Gradable

Ref.	Potencia Watts Puissance	Equipo Equipment Ballast	Largo Length Longueur	Raee EU Recyclable tax Ecotaxe	Precio Price Prix
D0313	15 W	●	471	0,50 €	32,42 €
D0319	15 W	●	471	0,50 €	34,84 €
D0314	18 W	●	624	0,50 €	34,66 €
D0320	18 W	●	624	0,50 €	37,10 €
D0352	18 W	●	624	0,50 €	52,99 €
D0439	18 W	●	624	0,50 €	92,99 €
D0316	30 W	●	928	0,50 €	50,63 €
D0322	30 W	●	928	0,50 €	54,08 €
D0338	30 W	●	928	0,50 €	57,48 €
D0317	36 W	●	1.233	0,50 €	54,82 €
D0323	36 W	●	1.233	0,50 €	57,96 €
D0353	36 W	●	1.233	0,50 €	64,46 €
D0440	36 W	●	1.233	0,50 €	104,46 €
D0318	58 W	●	1.534	0,50 €	67,70 €
D0324	58 W	●	1.534	0,50 €	72,30 €
D0354	58 W	●	1.534	0,50 €	69,70 €
D0441	58 W	●	1.534	0,50 €	109,70 €

4.2

Iluminación técnica / Iluminación comercial

Technical lighting / Commercial lighting

Éclairage technique / Éclairage commercial

1 TUBO FLUORESCENTE / 1 LAMP / 1 LAMPE

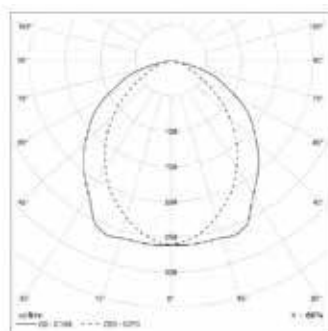
 G5
T5

Ref.	Potencia Watts Puissance	Equipo Equipment Ballast	Largo Length Longueur	Raee EU Recyclable tax Ecotaxe	Precio Price Prix
Alta Eficacia / High Efficiency / Haute Efficacité					
D0401	14 W	●	587	0,50 €	47,77 €
D0407	14 W	●	587	0,50 €	87,77 €
D0402	21 W	●	887	0,50 €	53,58 €
D0408	21 W	●	887	0,50 €	93,58 €
D0403	28 W	●	1.187	0,50 €	58,56 €
D0409	28 W	●	1.187	0,50 €	98,56 €
D0404	35 W	●	1.487	0,50 €	64,76 €
D0410	35 W	●	1.487	0,50 €	104,76 €
Alto Rendimiento / High Output / Flux Élevé					
D0420	24 W	●	587	0,50 €	47,77 €
D0423	24 W	●	587	0,50 €	87,77 €
D0405	39 W	●	887	0,50 €	53,58 €
D0411	39 W	●	887	0,50 €	93,58 €
D0421	49 W	●	1.487	0,50 €	64,76 €
D0424	49 W	●	1.487	0,50 €	104,76 €
D0406	54 W	●	1.187	0,50 €	58,56 €
D0412	54 W	●	1.187	0,50 €	98,56 €
D0422	80 W	●	1.487	0,50 €	73,56 €
D0425	80 W	●	1.487	0,50 €	113,56 €

- Electrónica / Electronic / Électronique
- Regulable / Dimmable / Gradable

2 TUBOS FLUORESCENTES / 2 LAMPS / 2 LAMPES

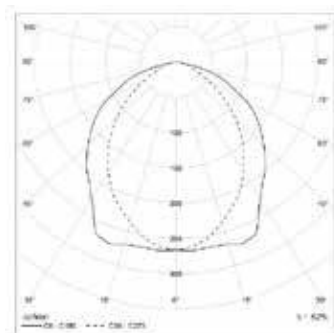

Ref.	Potencia Watts Puissance	Equipo Equipment Ballast	Largo Length Longueur	Raee EU Recyclable tax Ecotaxe	Precio Price Prix
Alta Eficacia / High Efficiency / Haute Efficacité					
D0442	14 W	●	587	0,50 €	56,67 €
D0451	14 W	●	587	0,50 €	96,67 €
D0443	21 W	●	887	0,50 €	64,35 €
D0452	21 W	●	887	0,50 €	104,35 €
D0444	28 W	●	1.187	0,50 €	66,21 €
D0453	28 W	●	1.187	0,50 €	106,21 €
D0445	35 W	●	1.487	0,50 €	72,32 €
D0454	35 W	●	1.487	0,50 €	112,32 €
Alto Rendimiento / High Output / Flux Élevé					
D0446	24 W	●	587	0,50 €	56,67 €
D0455	24 W	●	587	0,50 €	96,67 €
D0447	39 W	●	887	0,50 €	64,35 €
D0456	39 W	●	887	0,50 €	104,35 €
D0448	49 W	●	1.487	0,50 €	73,13 €
D0457	49 W	●	1.487	0,50 €	113,13 €
D0449	54 W	●	1.187	0,50 €	66,21 €
D0458	54 W	●	1.187	0,50 €	106,21 €
D0450	80 W	●	1.487	0,50 €	103,11 €
D0459	80 W	●	1.487	0,50 €	143,11 €

- Electrónica / Electronic / Électronique
- Regulable / Dimmable / Gradable



SUPERDELTA

Colegio L'Areny, Cornella, España

L'Areny School, Cornella, Spain

Ecole L'Areny, Cornella, Espagne

4.2

Iluminación técnica / Iluminación comercial

Technical lighting / Commercial lighting

Éclairage technique / Éclairage commercial



ES

Características generales

- Cuerpo luminaria: Chapa acero prelacada.
- Reflector: Aluminio brillante / opcional: chapa prelacada.
- Difusor: Policarbonato.
- Tapas finales: A.B.S.
- Temperatura de trabajo: De -15° C a +45° C.

EN

General characteristics

- Light fitting body: Lacquered steel.
- Reflector: Glossy aluminum /optional: laquered steel.
- Diffuser: Polycarbonate.
- End caps: A.B.S.
- Working temperature: From -15° C to +45° C.

FR

Caractéristiques générales

- Corps du luminaire: Acier laqué.
- Réflecteur: Aluminium brillant / optionnel: acier laqué.
- Diffuseur: Polycarbonate.
- Embouts: A.B.S.
- Température d'utilisation: De -15° C à +45° C.

1 TUBO FLUORESCENTE / 1 LAMP / 1 LAMPE

 G 13
T8

Ref.	Potencia Watts Puissance	Equipo Equipment Ballast	Largo Length Longueur	Raee EU Recyclable tax Ecotaxe	Precio Price Prix
D0825	18 W	●	624	0,50 €	54,02 €
D0831	18 W	●	624	0,50 €	94,02 €
D0826	36 W	●	1.233	0,50 €	76,08 €
D0834	36 W	●	1.233	0,50 €	116,08 €
D0827	58 W	●	1.534	0,50 €	79,94 €
D0835	58 W	●	1.534	0,50 €	119,94 €

● Electrónica / Electronic / Électronique

● Regulable / Dimmable / Gradable

2 TUBOS FLUORESCENTES / 2 LAMPS / 2 LAMPES

Ref.	Potencia Watts Puissance	Equipo Equipment Ballast	Largo Length Longueur	Raee EU Recyclable tax Ecotaxe	Precio Price Prix
D0828	18 W	●	624	0,50 €	60,23 €
D0836	18 W	●	624	0,50 €	100,23 €
D0829	36 W	●	1.233	0,50 €	78,65 €
D0839	36 W	●	1.233	0,50 €	118,65 €
D0830	58 W	●	1.534	0,50 €	87,72 €
D0840	58 W	●	1.534	0,50 €	127,72 €

● Electrónica / Electronic / Électronique

● Regulable / Dimmable / Gradable



Ficha técnica
Technical data
Fiche technique



DISPONIBLE PARA LED
CONSULTAR PRECIO

La luminaria incluye reflector, tapas finales y difusor
Light fitting includes reflector, end caps and diffuser
Luminaire comprend réflecteur, embouts et diffuseur



1 TUBO FLUORESCENTE / 1 LAMP / 1 LAMPE

G5
T5

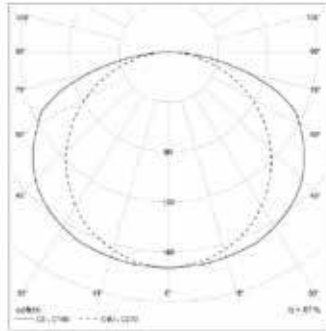

- Electrónica / Electronic / Électronique
- Regulable / Dimmable / Gradable

Ref.	Potencia Watts Puissance	Equipo Equipment Ballast	Largo Length Longueur	Raee EU Recyclable tax Ecotaxe	Precio Price Prix
Alta Eficacia / High Efficiency / Haute Efficacité					
D0850	14 W	●	587	0,50 €	52,77 €
D0851	14 W	●	587	0,50 €	92,77 €
D0852	21 W	●	887	0,50 €	61,49 €
D0853	21 W	●	887	0,50 €	101,49 €
D0854	28 W	●	1.187	0,50 €	68,83 €
D0855	28 W	●	1.187	0,50 €	108,83 €
D0856	35 W	●	1.487	0,50 €	79,30 €
D0857	35 W	●	1.487	0,50 €	119,30 €
Alto Rendimiento / High Output / Flux Élevé					
D0858	24 W	●	587	0,50 €	52,77 €
D0859	24 W	●	587	0,50 €	92,77 €
D0860	39 W	●	887	0,50 €	61,49 €
D0861	39 W	●	887	0,50 €	101,49 €
D0862	49 W	●	1.487	0,50 €	79,30 €
D0863	49 W	●	1.487	0,50 €	119,30 €
D0864	54 W	●	1.187	0,50 €	68,83 €
D0865	54 W	●	1.187	0,50 €	108,83 €
D0866	80 W	●	1.487	0,50 €	90,98 €
D0867	80 W	●	1.487	0,50 €	130,98 €

2 TUBOS FLUORESCENTES / 2 LAMPS / 2 LAMPES

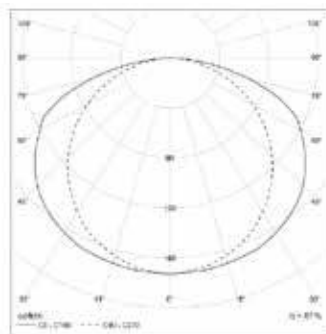

- Electrónica / Electronic / Électronique
- Regulable / Dimmable / Gradable

Ref.	Potencia Watts Puissance	Equipo Equipment Ballast	Largo Length Longueur	Raee EU Recyclable tax Ecotaxe	Precio Price Prix
Alta Eficacia / High Efficiency / Haute Efficacité					
D0868	14 W	●	587	0,50 €	62,13 €
D0869	14 W	●	587	0,50 €	102,13 €
D0870	21 W	●	887	0,50 €	70,69 €
D0871	21 W	●	887	0,50 €	110,62 €
D0872	28 W	●	1.187	0,50 €	77,48 €
D0873	28 W	●	1.187	0,50 €	117,48 €
D0874	35 W	●	1.487	0,50 €	88,48 €
D0875	35 W	●	1.487	0,50 €	128,48 €
Alto Rendimiento / High Output / Flux Élevé					
D0876	24 W	●	587	0,50 €	62,13 €
D0877	24 W	●	587	0,50 €	102,13 €
D0878	39 W	●	887	0,50 €	70,65 €
D0879	39 W	●	887	0,50 €	110,65 €
D0880	49 W	●	1.487	0,50 €	88,34 €
D0881	49 W	●	1.487	0,50 €	128,34 €
D0882	54 W	●	1.187	0,50 €	77,21 €
D0883	54 W	●	1.187	0,50 €	117,21 €
D0884	80 W	●	1.487	0,50 €	116,25 €
D0885	80 W	●	1.487	0,50 €	156,25 €

Accesorios / Accessories / Accessoires

Tapa final
End cap
Embout

Ref.	Precio Price Prix
D0841	1,17 €

Difusor
Diffuser
Diffuseur

T8			T5		
Mod.	Ref.	Precio Price Prix	Mod.	Ref.	Precio Price Prix
18 W	D0842	11,31 €	14-24 W	D0846	10,57 €
36 W	D0844	22,36 €	21-39 W	D0847	16,00 €
58 W	D0845	27,71 €	28-54 W	D0848	21,43 €
			35-80 W	D0849	26,87 €

4.2

Iluminación técnica / Iluminación comercial

Technical lighting / Commercial lighting

Éclairage technique / Éclairage commercial



ES

Características generales

- Cuerpo luminaria: Chapa acero prelacada.
- Reflector: Aluminio brillante / opcional: chapa prelacada.
- Difusor: Policarbonato.
- Tapas finales: A.B.S.
- Temperatura de trabajo: De -15° C a +45° C.

EN

General characteristics

- Light fitting body: Lacquered steel.
- Reflector: Glossy aluminum /optional: laquered steel.
- Diffuser: Polycarbonate.
- End caps: A.B.S.
- Working temperature: From -15° C to +45° C.

FR

Caractéristiques générales

- Corps du luminaire: Acier laqué.
- Réflecteur: Aluminium brillant / optionnel: acier laqué.
- Diffuseur: Polycarbonate.
- Embouts: A.B.S.
- Température d'utilisation: De -15° C à +45° C.

1 TUBO FLUORESCENTE / 1 LAMP / 1 LAMPE

G 13
T8

Ref.	Potencia Watts Puissance	Equipo Equipment Ballast	Largo Length Longueur	Raee EU Recyclable tax Ecotaxe	Precio Price Prix
D0925	18 W	●	624	0,50 €	80,21 €
D0931	18 W	●	624	0,50 €	120,21 €
D0926	36 W	●	1.233	0,50 €	101,90 €
D0932	36 W	●	1.233	0,50 €	141,90 €
D0927	58 W	●	1.534	0,50 €	106,28 €
D0933	58 W	●	1.534	0,50 €	146,28 €

● Electrónica / Electronic / Électronique

● Regulable / Dimmable / Gradable

2 TUBOS FLUORESCENTES / 2 LAMPS / 2 LAMPES

Ref.	Potencia Watts Puissance	Equipo Equipment Ballast	Largo Length Longueur	Raee EU Recyclable tax Ecotaxe	Precio Price Prix
D0928	18 W	●	624	0,50 €	77,43 €
D0934	18 W	●	624	0,50 €	117,43 €
D0929	36 W	●	1.233	0,50 €	102,65 €
D0935	36 W	●	1.233	0,50 €	142,65 €
D0930	58 W	●	1.534	0,50 €	112,35 €
D0936	58 W	●	1.534	0,50 €	152,35 €

● Electrónica / Electronic / Électronique

● Regulable / Dimmable / Gradable



Ficha técnica
Technical data
Fiche technique



DISPONIBLE PARA LED
CONSULTAR PRECIO

La luminaria incluye reflector, tapas finales y difusor
Light fitting includes reflector, end caps and diffuser
Luminaire comprend réflecteur, embouts et diffuseur

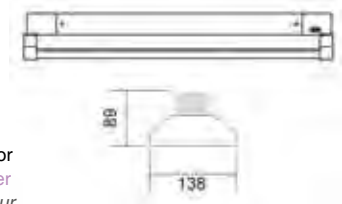

1 TUBO FLUORESCENTE / 1 LAMP / 1 LAMPE

G5
T5

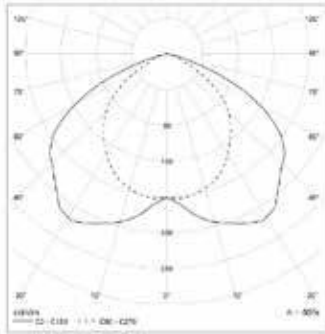

Ref.	Potencia Watts Puissance	Equipo Equipment Ballast	Largo Length Longueur	Raee EU Recyclable tax Ecotaxe	Precio Price Prix
Alta Eficacia / High Efficiency / Haute Efficacité					
D0937	14 W	●	587	0,50 €	80,72 €
D0955	14 W	●	587	0,50 €	120,72 €
D0938	21 W	●	887	0,50 €	93,15 €
D0956	21 W	●	887	0,50 €	133,15 €
D0939	28 W	●	1.187	0,50 €	98,20 €
D0957	28 W	●	1.187	0,50 €	138,20 €
D0940	35 W	●	1.487	0,50 €	108,31 €
D0958	35 W	●	1.487	0,50 €	148,31 €
Alto Rendimiento / High Output / Flux Élevé					
D0941	24 W	●	587	0,50 €	80,72 €
D0959	24 W	●	587	0,50 €	120,72 €
D0942	39 W	●	887	0,50 €	93,15 €
D0960	39 W	●	887	0,50 €	133,15 €
D0943	49 W	●	1.487	0,50 €	108,31 €
D0961	49 W	●	1.487	0,50 €	148,31 €
D0944	54 W	●	1.187	0,50 €	98,20 €
D0962	54 W	●	1.187	0,50 €	138,20 €
D0945	80 W	●	1.487	0,50 €	116,92 €
D0963	80 W	●	1.487	0,50 €	156,92 €

- Electrónica / Electronic / Électronique
- Regulable / Dimmable / Gradable

2 TUBOS FLUORESCENTES / 2 LAMPS / 2 LAMPES

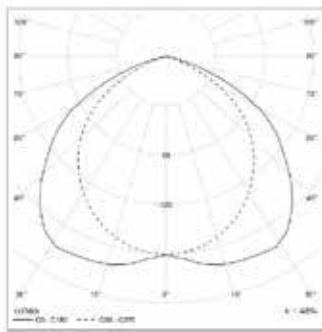

Ref.	Potencia Watts Puissance	Equipo Equipment Ballast	Largo Length Longueur	Raee EU Recyclable tax Ecotaxe	Precio Price Prix
Alta Eficacia / High Efficiency / Haute Efficacité					
D0946	14 W	●	587	0,50 €	89,49 €
D0964	14 W	●	587	0,50 €	129,49 €
D0947	21 W	●	887	0,50 €	101,73 €
D0965	21 W	●	887	0,50 €	141,73 €
D0948	28 W	●	1.187	0,50 €	114,50 €
D0966	28 W	●	1.187	0,50 €	154,50 €
D0949	35 W	●	1.487	0,50 €	115,38 €
D0967	35 W	●	1.487	0,50 €	155,38 €
Alto Rendimiento / High Output / Flux Élevé					
D0950	24 W	●	587	0,50 €	93,83 €
D0968	24 W	●	587	0,50 €	133,83 €
D0951	39 W	●	887	0,50 €	103,61 €
D0969	39 W	●	887	0,50 €	143,61 €
D0952	49 W	●	1.487	0,50 €	128,50 €
D0970	49 W	●	1.487	0,50 €	168,50 €
D0953	54 W	●	1.187	0,50 €	117,07 €
D0971	54 W	●	1.187	0,50 €	157,07 €
D0954	80 W	●	1.487	0,50 €	143,96 €
D0972	80 W	●	1.487	0,50 €	183,96 €

- Electrónica / Electronic / Électronique
- Regulable / Dimmable / Gradable

Accesorios / Accessories / Accessoires

Tapa final
End cap
Embout

Ref.	Precio Price Prix
D0901	2,37 €

Lama aluminio
Aluminium
louvre
Grille
aluminium

T8			T5		
Mod.	Ref.	€	Mod.	Ref.	€
1X18 W	D0909	33,33 €	1X14-24 W	D0905	33,33 €
1X36 W	D0903	41,67 €	1X21-39 W	D0906	41,67 €
1X58 W	D0904	47,41 €	1X28-54 W	D0907	41,67 €
2X18 W	D0910	33,33 €	1X35-80 W	D0908	47,41 €
2X36 W	D0911	41,67 €	2X14-24 W	D0913	33,33 €
2X58 W	D0912	47,41 €	2X21-39 W	D0914	41,67 €
			2X28-54 W	D0915	41,67 €
			2X35-80 W	D0916	47,41 €

4.3

Iluminación técnica / Iluminación industrial

Technical lighting / Industrial lighting

Éclairage technique / Éclairage industriel



ES

Se trata de una luminaria fluorescente TC-L portátil diseñada principalmente para actuaciones de protección civil en situaciones de emergencia.

La luminaria posee un reflector en aluminio metalizado, ofreciendo de esta manera una iluminación uniforme de 360° de gran perímetro.

Gracias a su difusor en policarbonato opal evita los deslumbramientos.

Dispone de una toma de aire superior y otra inferior, además del ventilador para la refrigeración de la luminaria.

La alimentación de la luminaria se realiza mediante una manguera (3x1,5 mm²) de 4 metros de longitud, situada en la parte inferior de la luminaria con Schuko para facilitar su conexión.

Incluye un trípode para poder elevar la luminaria y ampliar la superficie a iluminar. Dispone de un eje en la parte inferior de la luminaria para su fijación al trípode.

El baúl con el que se suministra este modelo esta fabricado en material de alta resistencia frente a impactos.

Características generales

- Reflector: Aluminio metalizado.
- Difusor: Policarbonato opal de 3 mm de espesor.
- Tapas finales: Aluminio anodizado.
- Fuente de luz: 8 unidades de 80 W TC-L (incluidas).
- Potencia máxima: 735 W.
- Equipo electrónico: 4 unidades 2x80 W Philips, serie HF-P.
- Temperatura de trabajo: De -15°C a 40°C.
- Superficie iluminada: 2.400 m²
- Número de lúmenes: 52.000 lm.
- Ensayo filamento incandescente: 960°C.

EN

It is a portable TC-L fluorescent fitting designed mainly for civil protection use in emergency situations.

The light fixture has a metallic aluminium reflector, offering in this way uniform lighting the 360° around it. Thanks to its matte polycarbonate diffuser avoids glare. It is formed by a top and bottom air supplies, aside from a fan for refrigeration purposes.

The power source comes through a cable guide (3x1,5 mm²) of 4 metres in length, situated at the bottom with Schuko to ease its connection.

A tripod is included to elevate the light fixture and extend the lighting area. It has an axis at the bottom of the light fixture for the purpose of tripod affixing.

The light fitting is sent in a trunk manufactured in an impact proof hightresistance material.

General characteristics

- Reflector: Metallic aluminium.
- Diffuser: Matte polycarbonate 3 mm thickness.
- End caps: Anodized aluminium.
- Lamp type: 8 piece lamp 80W TC-L (included).
- Maximum power: 735W.
- Electronic ballast: 4 piece 2x80W Philips, serie HF-P.
- Working temperature: From -15°C to +40°C.
- Lighted surface: 2.400 m².
- Number of lumens: 52.000 lm.
- Glow wire test: 960°C.

FR

Luminaire fluorescent TC-L avec une enveloppe composé d'un tube de polycarbonate de 3 mm d'épaisseur, ce qui lui donne une grande robustesse. Embouts en aluminium anodisé.

Réflecteur prismatique de section carrée, en situant deux tubes fluorescents TC-L dans chacune des faces, offrant de cette façon un éclairage uniforme sur les 360° du luminaire. Réflecteur en aluminium spéculaire pour obtenir un rendement plus haut. Diffuseur en polycarbonate opal.

Il dispose de deux entrées d'air, une supérieure, l'autre inférieure, et aussi un ventilateur pour la réfrigération du luminaire.

On inclue un trépied pour élever le luminaire et agrandir la surface d'éclairage. On dispose d'un axe dans la partie inférieure du luminaire pour sa fixation au trépied.

L'alimentation du luminaire est réalisée avec un câble (3x1.5 mm²) de 4 mètres de longueur, située dans la partie inférieure du luminaire avec Schuko pour faciliter sa connexion.

Groupe électrogène préconisé: 1 kW.

Caractéristiques générales

- Réflecteur: Aluminium spéculaire.
- Diffuseur: Polycarbonate opal de 3 mm de épaisseur.
- Embouts: Aluminium anodisé.
- Type de lampes: 8 unités de lampes 80 W TC-L (inclues).
- Puissance maximale: 735 W
- Ballast: 4 unités 2x80 W Philips, série HF-P.
- Température d'utilisation: De -15°C à 40°C.
- Surface éclairée: 2.400 m²
- Lumens: 52.000 lm.
- Essai du fil incandescent: 960°C.



Ficha técnica
Technical data
Fiche technique



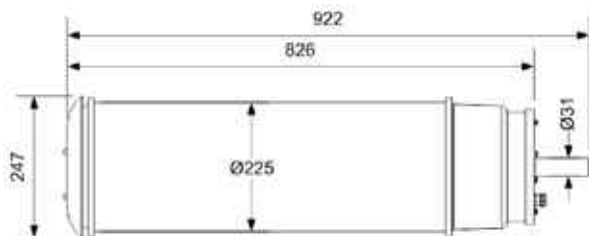

Ref.	Rae EU Recyclable tax Ecotaxe	Precio Price Prix
EXT01	0,70 €	3.048,05 €

ACCESORIOS / ACCESSORIES / ACCESSOIRES

REF. EXT10

727,11 €

Trípode
Tripod
Trépied



4.3

Iluminación técnica / Iluminación industrial

Technical lighting / Industrial lighting

Éclairage technique / Éclairage industriel



ES

Extraordinaria calidad para un producto, normalmente ubicado en sitios de difícil acceso, para garantizar la falta de problemas y la eficacia de la misma.

Posibilidad de conversión a IP65.

Características generales

- Reflector: Aluminio brillante.
- Chimenea: Aluminio extrusionado con 32 alas y gran poder de refrigeración.
- Equipo: Europeo.
- Temperatura de trabajo: De -5° C a +40° C.
- Al modelo LUMI CLASSIC se puede añadir un disco de vidrio templado Ø 452 mm x 4 mm y unas juntas de silicona que proporcionan las características necesarias para dicho índice de protección.
- Diferentes modelos en B.F. y A.F. Para diferentes lámparas de descarga (vapor de sodio y halógenos metálicos).

Lámpara no incluida.

EN

Superb quality for a product that tends to be situated in areas that are hard to reach, thus making it problem-free and extremely efficient.

May be converted to IP65.

General characteristics

- Reflector: Glossy aluminium.
- Chimney: Extruded aluminium shaft with 32 wings and great refrigeration power.
- Equipment: European.
- Working temperature: From -5° C to +40° C.
- A tempered glass disc Ø 452 x 4 mm and silicon gaskets are available for the LUMI CLASSIC which provides the necessary characteristics for its protection rating.
- Different models in low and high factor for different discharge lamps (high pressure sodium and metal halide lamp).

Lamp not included.

FR

Armature industrielle d'extraordinaire qualité pour un produit, normalement placé dans des lieux de difficile accès, pour garantir l'absence de problèmes et l'efficacité de l'éclairage.

Possibilité de conversion à IP65.

Caractéristiques générales

- Réflecteur: Aluminium brillant.
- Chimenea: Aluminium extrude, grande capacité de réfrigération.
- Ballast: Européen.
- Température d'utilisation: De -5° C à +40° C.
- Un disque de verre trempé Ø 452 x 4 mm et des joints de silicone peuvent être ajoutés au modèle LUMI CLASSIC pour avoir les caractéristiques nécessaires pour atteindre un niveau de protection IP65.
- Différents modèles en non-compensé et compensé pour différents modèles de lampes de décharge (vapeur de sodium et iodures métalliques).

Lampe non incluse.



Ficha técnica
Technical data
Fiche technique

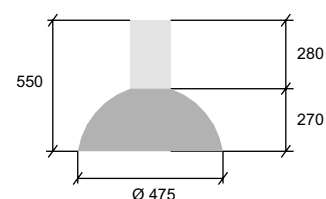

Ref.	Potencia Watts Puissance	Equipo Equipment Ballast	Raee EU Recyclable tax Ecotaxe	Precio Price Prix
Sin Equipo / Without Equipment / Sans Ballast				
L0E27			0,70 €	138,63 €
L0E40			0,70 €	140,27 €
Vapor Sodio / Sodium / Vapeur de Sodium				
LS70B	70 W	●	0,70 €	178,01 €
LS70A	70 W	●	0,70 €	181,88 €
LS10B	100 W	●	0,70 €	183,25 €
LS10A	100 W	●	0,70 €	187,11 €
LS15B	150 W	●	0,70 €	190,02 €
LS15A	150 W	●	0,70 €	194,75 €
LS25B	250 W	●	0,70 €	206,57 €
LS25A	250 W	●	0,70 €	213,11 €
LS40B	400 W	●	0,70 €	217,11 €
LS40A	400 W	●	0,70 €	225,66 €
Halogenuros Metálicos / Metal Halide / Iodures Métalliques				
LH70B	70 W	●	0,70 €	178,01 €
LH70A	70 W	●	0,70 €	181,88 €
LH10B	100 W	●	0,70 €	179,56 €
LH10A	100 W	●	0,70 €	183,42 €
LH15B	150 W	●	0,70 €	188,38 €
LH15A	150 W	●	0,70 €	193,11 €
LH25B	250 W	●	0,70 €	191,97 €
LH25A	250 W	●	0,70 €	198,52 €
LH40B	400 W	●	0,70 €	205,47 €
LH40A	400 W	●	0,70 €	212,47 €

● Bajo factor / Low factor / Non-compensé

● Alto factor / High factor / Compensé

Accesorios / Accessories / Accessoires

	Ref.	Precio Price Prix
Conversión a IP65 con cristal incluido IP65 with tempered glass Conversion à IP65 avec verre incluse	LIP65	30,79 €
Reflector aluminio Aluminium reflector Réflecteur aluminium	LREFG	84,56 €
Cierre de vidrio templado Tempered glass Fermeture de verre trempé	LVIDR	18,08 €

4.3

Iluminación técnica / Iluminación industrial

Technical lighting / Industrial lighting

Éclairage technique / Éclairage industriel

**ES****Características generales**

- Chimenea: Aluminio inyectado.
- Equipo: Europeo.
- Temperatura de trabajo: De -5° C a +45° C.
- Cristal cierre IP65 incluido.
- Disponibles diferentes modelos en bajo y alto factor.
- Para diferentes lámparas de descarga (vapor de sodio y halogenuros metálicos).

Lámpara no incluida.

EN**General characteristics**

- Reflector: Aluminum.
- Chimney: Injected aluminium.
- Equipment: European.
- Working temperature: From -5° C to +45° C.
- IP65 tempered glass included.
- Different models in low and high factor for different discharge lamps (high pressure sodium and metal halide lamp).

Lamp not included.

FR**Caractéristiques générales**

- Reflector: Aluminium.
- Chimenea: Aluminium injecté.
- Ballast: Européen.
- Température d'utilisation: De -5° C à +45° C.
- Verre IP65 incluse.
- Différents modèles en compensé et non-compensé pour différents types de lampes de décharge (vapeur de sodium et iodures métalliques).

Lampe non incluse.



Ficha técnica
Technical data
Fiche technique



Ref.	Potencia Watts Puissance	Equipo Equipment Ballast	Raee EU Recyclable tax Ecotaxe	Precio Price Prix
Sin Equipo / Without Equipment / Sans Ballast				
LFE27			0,70 €	114,71 €
LFE40			0,70 €	106,77 €
Vapor Sodio / Sodium / Vapeur de Sodium				
LFS1A	70 W	●	0,70 €	182,35 €
LFS1B	70 W	●	0,70 €	178,48 €
LFS2A	100 W	●	0,70 €	178,09 €
LFS2B	100 W	●	0,70 €	174,23 €
LFS3A	150 W	●	0,70 €	186,09 €
LFS3B	150 W	●	0,70 €	181,32 €
LFS4A	250 W	●	0,70 €	205,09 €
LFS4B	250 W	●	0,70 €	198,54 €
LFS5A	400 W	●	0,70 €	221,18 €
LFS5B	400 W	●	0,70 €	212,64 €
Halogenuros Metálicos / Metal Halide / Iodures Métalliques				
LFH1A	70 W	●	0,70 €	182,35 €
LFH1B	70 W	●	0,70 €	178,48 €
LFH2A	100 W	●	0,70 €	186,03 €
LFH2B	100 W	●	0,70 €	182,16 €
LFH3A	150 W	●	0,70 €	193,98 €
LFH3B	150 W	●	0,70 €	189,26 €
LFH4A	250 W	●	0,70 €	190,00 €
LFH4B	250 W	●	0,70 €	183,45 €
LFH5A	400 W	●	0,70 €	202,59 €
LFH5B	400 W	●	0,70 €	195,59 €

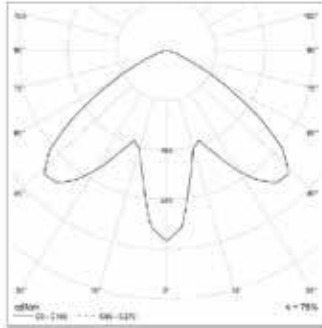

- Alto factor / High factor / Compensé
- Bajo factor / Low factor / Non-compensé

LÁMPARA AUXILIAR PARA LUMI CLASSIC Y FORTE AUXILIARY LAMP FOR LUMI CLASSIC AND FORTE LAMPE AUXILIAIRE POUR LUMI CLASSIC ET FORTE



Lámpara auxiliar
Auxiliary lamp
Lampe auxiliaire

	Ref.	Precio Price Prix
Para vapor sodio y halogenuros metálicos: 70, 100 y 150 W For sodium and metal halide: 70, 100 and 150 W Pour vapeur de sodium et iodures métalliques: 70, 100 y 150 W	LAUX1	127,01 €
Para halogenuros metálicos 250 W y 400 W For metal halide 250 W and 400 W Pour iodures métalliques 250 W y 400 W	LAUX2	129,06 €

Suplemento lámpara auxiliar para LUMI CLASSIC y FORTE
Auxiliary lamp supplement for the LUMI CLASSIC and FORTE
Supplément lampe auxiliaire pour LUMI CLASSIC et FORTE



4.3

Iluminación técnica / Iluminación industrial

Technical lighting / Industrial lighting

Éclairage technique / Éclairage industriel



Color Colour Couleur	Ral.	Ref.
	9010	B
	9011	N

ES

Las esferas forman parte del mobiliario urbano al que todos estamos acostumbrados. Es un clásico del alumbrado público que se mantiene, a pesar de las modas y los nuevos diseños.

Además del alumbrado público, también se utiliza para urbanizaciones, chalets, fincas, etc.

Características generales

- Esfera: Polietileno.
- Base portaesferas: Policarbonato.
- Equipo: Europeo.

EN

Spheres are a familiar part of urban design. They are classic in street lighting and are still popular despite changing fashions and new designs. Aside from street lighting, they are also used in urban developments, houses, properties, etc.

General characteristics

- Sphere: Polyethylene.
- Sphereholder: Polycarbonate.
- Equipment: European.

FR

Les sphères forment partie du mobilier urbain auquel on est tous habitué. C'est un classique de l'éclairage public qui reste, malgré les modes et les nouvelles conceptions.

Également que pour l'éclairage public, elles sont aussi utilisées dans des urbanisations, chalets, etc.

Caractéristiques générales

- Sphère: Polyéthylène.
- Base porte sphères: Polycarbonate.
- Equipe: Européen.



Ficha técnica
Technical data
Fiche technique

BASES / SPHEREHOLDERS / BASES

Ref.	Potencia Watts Puissance	Equipo Equipment Ballast	Uso con esfera Use with sphere Usage avec sphère	Raee EU Recyclable tax Ecotaxe	Precio Price Prix
Sin Equipo / Without Equipment / Sans Ballast					
B000			400 / 450 mm.		46,96 €
BE27			400 / 450 mm.		51,04 €
BE40			450 mm.		54,00 €
Vapor Sodio / Sodium / Vapeur de Sodium					
BS70B	70 W	●	400 / 450 mm.	0,50 €	92,59 €
BS70A	70 W	●	400 / 450 mm.	0,50 €	97,47 €
BS10B	100 W	●	450 mm.	0,70 €	100,20 €
BS10A	100 W	●	450 mm.	0,70 €	105,09 €
BS15B	150 W	●	450 mm.	0,70 €	109,34 €
BS15A	150 W	●	450 mm.	0,70 €	115,32 €
BS25B	250 W	●	450 mm.	0,70 €	131,00 €
BS25A	250 W	●	450 mm.	0,70 €	139,28 €
Halogenuros Metálicos / Metal Halide / Iodures Métalliques					
BH70B	70 W	●	400 / 450 mm.	0,50 €	92,59 €
BH70A	70 W	●	400 / 450 mm.	0,50 €	97,47 €
BH10B	100 W	●	400 / 450 mm.	0,50 €	94,66 €
BH10A	100 W	●	400 / 450 mm.	0,50 €	99,54 €
BH15B	150 W	●	450 mm.	0,50 €	106,27 €
BH15A	150 W	●	450 mm.	0,50 €	112,24 €
BH25B	250 W	●	450 mm.	0,70 €	111,65 €
BH25A	250 W	●	450 mm.	0,70 €	119,92 €

● Bajo factor / Low factor / Non-compensé

● Alto factor / High factor / Compensé



4.3

Iluminación técnica / Iluminación industrial

Technical lighting / Industrial lighting

Éclairage technique / Éclairage industriel



Color Colour Couleur	Ral.	Ref.
	9010	B
	9011	N

ESFERAS POLIETILENO
POLYETHYLENE SPHERES
SPHÈRES DE POLYÉTHYLÈNE

Ref.	Diámetro Diameter Diamètre	Boca Hole Overture	Precio Price Prix
EP300	300 mm.	100 mm.	15,65 €
EP400	400 mm.	160 mm.	37,65 €
EP450	450 mm.	160 mm.	53,08 €

* Siempre a portes debidos

ACCESORIOS PARA ESFERA 300 MMS.
ACCESSORIES FOR SPHERE 300 MMS.
ACCESSOIRES POUR SPHÈRE 300 MMS.

REF. B309

55,90 €



Pie de sobremesa, pared o techo
Round table base, wall or ceiling
Support pour sol, mur et plafond

REF. B307

48,51 €



Extensible
Tensive
Extensible

REF. B314

27,08 €



Cable de acero
Steel cable
Câble en acier

REF. B315

20,10 €



Base plana
Round table base
Base plate



Suspensión con Tija
Stem suspension
Suspension avec tige

Ref.	Descripción Description	Precio Price Prix
B302	Tija 250 mm / Stem 250 mm / Tige 250 mm	27,27 €
B303	Tija 500 mm / Stem 500 mm / Tige 500 mm	30,18 €
B304	Tija 1000 mm / Stem 1000 mm / Tige 1000 mm	33,81 €
B305	Tija 1500 mm / Stem 1500 mm / Tige 1500 mm	42,64 €

ACCESORIOS PARA ESFERA 400 Y 450 MMS.
ACCESSORIES FOR SPHERE 400 AND 450 MMS.
ACCESSOIRES POUR SPHÈRE 400 ET 450 MMS.

REF. B316

53,50 €



Cable de acero
Steel cable
Càble en acier



Suspensión con Tija
Stem suspension
Suspension avec tige

Ref.	Descripción Description	Precio Price Prix
B310	Tija 250 mm / Stem 250 mm / Tige 250 mm	53,86 €
B311	Tija 500 mm / Stem 500 mm / Tige 500 mm	56,77 €
B312	Tija 1000 mm / Stem 1000 mm / Tige 1000 mm	60,41 €
B313	Tija 1500 mm / Stem 1500 mm / Tige 1500 mm	69,24 €

REF. B317

35,79 €



Pie de sobremesa
Round table base
Support pour sol

Los accesorios para esferas de 400 y 450 mms. no incluyen la base portaesferas.

Accessories for 400 and 450 mms. spheres don't include the sphereholder.

Los accessoires pour les sphères de 400 et 450 mms. Celles-ci ne comprennent les bases porte-sphères.

4.3

Iluminación técnica / Iluminación industrial
Technical lighting / Industrial lighting
Éclairage technique / Éclairage industriel



ES

Características generales

- Material: Makrolon 1243 de Bayer: Policarbonato extrusionado estabilizado ante los rayos U.V. (espesor 0,5 mm).
- Tapones: A.B.S. posibilidad de tapones abiertos o cerrados en T8. En T5 tapones abiertos y T12 tapones cerrados.
- Embalaje: T5: 60 unidades.
T8: 30 unidades.
T12: 15 unidades.

EN

General characteristics

- Material: Makrolon 1243 Bayer: Extruded polycarbonate specially stabilised for the action of ultraviolet rays (0.50 thickness).
- End caps: A.B.S. available open and close end caps in T8. In T5 open end caps, T12 close end caps.
- Packaging: T5: 60 units.
T8: 30 units.
T12: 15 units.

FR

Caractéristiques générales

- Matériel: Makrolon 1243, Bayer: Polycarbonate extrudé stabilisé face au rayonnement U.V. (épaisseur 0.5mm)
- Bouchons: A.B.S. possibilité de bouchons ouverts ou fermés en T8. En T5 bouchons ouverts et T12 bouchons fermés.
- Carton: T5: 60 unités.
T8: 30 unités.
T12: 15 unités.

COLORES DISPONIBLES
AVAILABLE COLOURS
COULEURS DISPONIBLES



Transparente / **Transparent**



Azul / **Blue / Bleu**



Rojo / **Red / Rouge**



Metalizado / **Metallic / Métallisé**



Amarillo / **Yellow / Jaune**



Naranja / **Orange / Orange**



Verde / **Green / Vert**



Ficha técnica
 Technical data
 Fiche technique



T5 - 16 MM



Ref.	Potencia Watts Puissance	Largo Length Longueur	Color Colour Couleur	Precio Price Prix
T5014	14-24 W	548 mm.	Transparente / Transparent	1,38 €
T5A14	14-24 W	548 mm.	Amarillo / Yellow / Jaune	2,14 €
T5C14	14-24 W	548 mm.	Azul / Blue / Bleu	2,14 €
T5N14	14-24 W	548 mm.	Naranja / Orange / Orange	2,14 €
T5R14	14-24 W	548 mm.	Rojo / Red / Rouge	2,14 €
T5V14	14-24 W	548 mm.	Verde / Green / Vert	2,14 €
T5021	21-39 W	847 mm.	Transparente / Transparent	2,00 €
T5A21	21-39 W	847 mm.	Amarillo / Yellow / Jaune	2,94 €
T5C21	21-39 W	847 mm.	Azul / Blue / Bleu	2,94 €
T5N21	21-39 W	847 mm.	Naranja / Orange / Orange	2,94 €
T5R21	21-39 W	847 mm.	Rojo / Red / Rouge	2,94 €
T5V21	21-39 W	847 mm.	Verde / Green / Vert	2,94 €
T5028	28 W	1148 mm.	Transparente / Transparent	2,65 €
T5A28	28 W	1148 mm.	Amarillo / Yellow / Jaune	4,07 €
T5C28	28 W	1148 mm.	Azul / Blue / Bleu	4,07 €
T5N28	28 W	1148 mm.	Naranja / Orange / Orange	4,07 €
T5R28	28 W	1148 mm.	Rojo / Red / Rouge	4,07 €
T5V28	28 W	1148 mm.	Verde / Green / Vert	4,07 €
T5035	35-49 W	1448 mm.	Transparente / Transparent	3,27 €
T5A35	35-49 W	1448 mm.	Amarillo / Yellow / Jaune	5,03 €
T5C35	35-49 W	1448 mm.	Azul / Blue / Bleu	5,03 €
T5N35	35-49 W	1448 mm.	Naranja / Orange / Orange	5,03 €
T5R35	35-49 W	1448 mm.	Rojo / Red / Rouge	5,03 €
T5V35	35-49 W	1448 mm.	Verde / Green / Vert	5,03 €

T12 - 38 MM



Ref.	Potencia Watts Puissance	Largo Length Longueur	Color Colour Couleur	Precio Price Prix
SP020	20 W	590 mm.	Transparente / Transparent	3,64 €
SPA20	20 W	590 mm.	Amarillo / Yellow / Jaune	5,41 €
SPC20	20 W	590 mm.	Azul / Blue / Bleu	5,41 €
SPR20	20 W	590 mm.	Rojo / Red / Rouge	5,41 €
SPV20	20 W	590 mm.	Verde / Green / Vert	5,41 €
SP040	40 W	1200 mm.	Transparente / Transparent	6,87 €
SPA40	40 W	1200 mm.	Amarillo / Yellow / Jaune	10,05 €
SPC40	40 W	1200 mm.	Azul / Blue / Bleu	10,05 €
SPR40	40 W	1200 mm.	Rojo / Red / Rouge	10,05 €
SPV40	40 W	1200 mm.	Verde / Green / Vert	10,05 €
SP065	65 W	1500 mm.	Transparente / Transparent	8,45 €
SPA65	65 W	1500 mm.	Amarillo / Yellow / Jaune	12,35 €
SPC65	65 W	1500 mm.	Azul / Blue / Bleu	12,35 €
SPR65	65 W	1500 mm.	Rojo / Red / Rouge	12,35 €
SPV65	65 W	1500 mm.	Verde / Green / Vert	12,35 €

T8 - 26 MM



Ref.	Potencia Watts Puissance	Largo Length Longueur	Color Colour Couleur	Precio Price Prix
TP015	15 W	437 mm.	Transparente / Transparent	1,73 €
TPA15	15 W	437 mm.	Amarillo / Yellow / Jaune	3,28 €
TPC15	15 W	437 mm.	Azul / Blue / Bleu	3,28 €
TPN15	15 W	437 mm.	Naranja / Orange / Orange	3,28 €
TPR15	15 W	437 mm.	Rojo / Red / Rouge	3,28 €
TPV15	15 W	437 mm.	Verde / Green / Vert	3,28 €
TPM15	15 W	437 mm.	Metalizado / Metallic / Métallisé	6,56 €
TP018	18 W	588 mm.	Transparente / Transparent	2,15 €
TPA18	18 W	588 mm.	Amarillo / Yellow / Jaune	3,28 €
TPC18	18 W	588 mm.	Azul / Blue / Bleu	3,28 €
TPN18	18 W	588 mm.	Naranja / Orange / Orange	3,28 €
TPR18	18 W	588 mm.	Rojo / Red / Rouge	3,28 €
TPV18	18 W	588 mm.	Verde / Green / Vert	3,28 €
TPM18	18 W	588 mm.	Metalizado / Metallic / Métallisé	6,56 €
TP030	30 W	893 mm.	Transparente / Transparent	3,13 €
TPA30	30 W	893 mm.	Amarillo / Yellow / Jaune	6,38 €
TPC30	30 W	893 mm.	Azul / Blue / Bleu	6,38 €
TPN30	30 W	893 mm.	Naranja / Orange / Orange	6,38 €
TPR30	30 W	893 mm.	Rojo / Red / Rouge	6,38 €
TPV30	30 W	893 mm.	Verde / Green / Vert	6,38 €
TPM30	30 W	893 mm.	Metalizado / Metallic / Métallisé	13,01 €
TP036	36 W	1198 mm.	Transparente / Transparent	4,07 €
TPA36	36 W	1198 mm.	Amarillo / Yellow / Jaune	6,41 €
TPC36	36 W	1198 mm.	Azul / Blue / Bleu	6,41 €
TPN36	36 W	1198 mm.	Naranja / Orange / Orange	6,41 €
TPR36	36 W	1198 mm.	Rojo / Red / Rouge	6,41 €
TPV36	36 W	1198 mm.	Verde / Green / Vert	6,41 €
TPM36	36 W	1198 mm.	Metalizado / Metallic / Métallisé	13,03 €
TP058	58 W	1498 mm.	Transparente / Transparent	5,07 €
TPA58	58 W	1498 mm.	Amarillo / Yellow / Jaune	7,88 €
TPC58	58 W	1498 mm.	Azul / Blue / Bleu	7,88 €
TPN58	58 W	1498 mm.	Naranja / Orange / Orange	7,88 €
TPR58	58 W	1498 mm.	Rojo / Red / Rouge	7,88 €
TPV58	58 W	1498 mm.	Verde / Green / Vert	7,88 €
TPM58	58 W	1498 mm.	Metalizado / Metallic / Métallisé	16,22 €

* En cada aplicación se debe comprobar que los tubos protectores no superen los 100° C de temperatura superficial.
En T8 sólo se servirán embalajes completos.

Protective tubes do not resist more than 100 °C surface temperature.

Chaque application doit vérifier que les tubes protecteurs ne dépassent pas 100 °C température de surface.

** Los tapones de los tubos protectores T5 no son válidos para los tubos fluorescentes de marca Sylvania por motivos de dimensiones.
The end caps for the T5 protective tubes are not allowed for Sylvania fluorescent tubes because of dimensions.

Pour chaque usage il faut vérifier que la température en superficie des tubes protecteurs ne dépasse pas les 100°C .

4.3

Iluminación técnica / Iluminación industrial
Technical lighting / Industrial lighting
Éclairage technique / Éclairage industriel

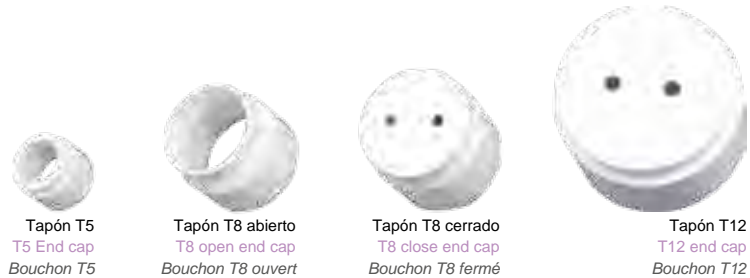

PARA T5 DE 54 W Y 80 W
FOR T5 OF 54 W AND 80 W
POUR T5 DE 54 W ET 80 W

ES

Los tubos fluorescentes de Alto rendimiento de 54W y 80W generan más calor que otros tubos, por lo cual se deben utilizar tubos protectores que disipen mejor el calor generado. Para estos casos se dispone de tubos protectores especiales compuestos de un tubo protector T8 ajustado a la medida de 54 W y 80 W y 2 tapones reductores que sujetan el tubo fluorescente T5, tal como se aprecia en la figura.

EN

High Output (H.O.) fluorescent tubes generate more heat than others, therefore protective tubes that better dissipate the generated heat must be used. For these cases we have available special protective tubes compounded of a T8 protective tube adjusted to the 54 W and 80 W measurements and 2 fitted caps that hold the T5 fluorescent tube, as seen in the figure.

FR

Les tubes fluorescents de flux élevé de 54W et 80W produisent plus de chaleur que les autres tubes, c'est pour ça qu'on doit utiliser des tubes protecteurs qui dissipent mieux la chaleur produite. Pour ces cas, on dispose de tubes protecteurs spéciaux composés d'un tube T8, adaptés à la mesure de 54W et 80W et deux bouchons réducteurs qui fixent le lampe T5, comme on peut voir dans la figure cidessous.

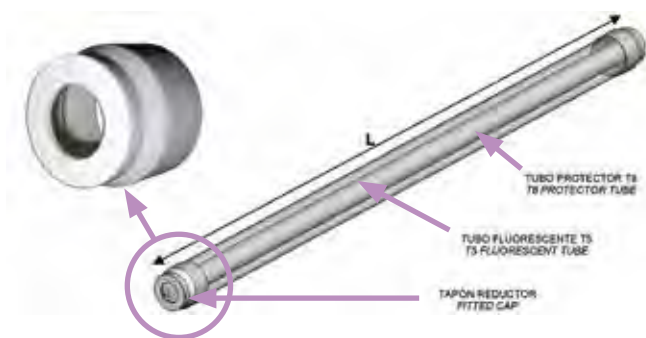

Ref.	Potencia Watts Puissance	Largo Length Longueur	Color Colour Couleur	Precio Price Prix
T5055	54 W	1148 mm.	Transparente / Transparent	5,09 €
T5A55	54 W	1148 mm.	Amarillo / Yellow / Jaune	6,45 €
T5C55	54 W	1148 mm.	Azul / Blue / Bleu	6,45 €
T5N55	54 W	1148 mm.	Naranja / Orange / Orange	6,45 €
T5R55	54 W	1148 mm.	Rojo / Red / Rouge	6,45 €
T5V55	54 W	1148 mm.	Verde / Green / Vert	6,45 €
T5080	80 W	1448 mm.	Transparente / Transparent	5,10 €
T5A80	80 W	1448 mm.	Amarillo / Yellow / Jaune	7,92 €
T5C80	80 W	1448 mm.	Azul / Blue / Bleu	7,92 €
T5N80	80 W	1448 mm.	Naranja / Orange / Orange	7,92 €
T5R80	80 W	1448 mm.	Rojo / Red / Rouge	7,92 €
T5V80	80 W	1448 mm.	Verde / Green / Vert	7,92 €

NORMAS PARA TUBOS PROTECTORES

NORMS FOR PROTECTIVE TUBE

NORMES POUR LES TUBES PROTECTEURS

ES

Compatible con las regulaciones establecidas en el HACCP (Hazard Analysis and Critical Control Points). El Reglamento sobre condiciones sanitarias en los establecimientos y actividades de comidas preparadas (BOA de 7 de junio de 2006) establece:

“En los locales donde existan alimentos, los elementos de iluminación estarán provistos de dispositivos que protejan aquellos de una posible contaminación en caso de rotura”.

Tubos protectores de policarbonato con aditivos contra los rayos ultravioletas

Los tubos, además de proteger a los fluorescentes, evitan en caso de rotura de éstos, que la sustancia nociva para la salud de su interior pase al exterior en caso de rotura.

Utilizando tubos de colores se transforma un tubo fluorescente normal en un tubo de color. Los tubos protectores permiten una fácil limpieza.

Protección de tubos fluorescentes

La protección de los tubos fluorescentes va implantándose cada vez más para evitar posibles accidentes. Así lo especifican los reglamentos técnicos sanitarios publicados en distintos Boletines Oficiales del Estado cuando indican: “Los elementos de iluminación estarán provistos de dispositivos que protejan a los alimentos de una posible contaminación en caso de rotura”.

Por estos motivos, la protección de los tubos fluorescentes es:

- OBLIGADA en establecimientos del ramo de la alimentación como: industrias cárnicas, carnicerías, charcuterías, cocinas y preparación de comidas, locales de manipulación y venta de pescado, etc.
- MUY RECOMENDABLE en establecimientos de pública concurrencia como: estaciones de ferrocarril, escuelas, parques de atracciones, grandes almacenes, hoteles, restaurantes, etc.

EN

Compatible with the regulations established in the HACCP (Hazard Analysis and Critical Control Points).

Regulations on health conditions in catering establishments and activities (BOA date 7 June 2006) sets:

“In rooms where there are food, lighting systems will be provided of devices that protect those of a possible contamination in case of breakage”.

Polycarbonate protective tubes with additives against ultraviolet rays

Apart from protecting the fluorescent tubes, they prevent contaminating dust on the inside from getting out, in case of breakage.

When coloured tubes are used, a normal fluorescent tube becomes a coloured tube. The protective tubes allow easy cleaning.

Fluorescent tube protection

Protection of fluorescent tubes is becoming more and more common, in order to avoid possible accidents. This is specified by the technical-sanitary regulations published in various Official State Gazettes, which say: “Lighting elements will be equipped with devices to protect food and possible contamination in case of breakage”.

For this reason, the protection of fluorescent tubes is:

- COMPULSORY in food-handling establishments, such as meat industries, butchers, kitchens and places where food is prepared, places where fish is sold and handled, etc.
- VERY ADVISABLE in public establishments such as railway stations, schools, fairgrounds, large stores, hotels, restaurants, etc.

FR

Compatible avec les régulations établies dans la HACCP (Hazard Analysis and Critical Control Points).

Le règlement sur les conditions sanitaires dans les établissements d'aliments préparés (BOA du 7 juin de 2006) établie :

“Dans les établissements où ils existent des aliments, les éléments d'éclairage seront accompagnés de dispositifs qui protègent ceux-ci d'une possible contamination s'il existe une rupture.”

Tubes protecteurs de polycarbonate avec additifs contre le rayonnement ultraviolet

Les tubes, à part de protéger les fluorescents, évitent s'il existe une rupture, que la substance nocive pour la santé qui se trouve à l'intérieur des tubes passe à l'extérieur.

Utilisant des tubes de couleurs, on transforme facilement un LAMPE normal en un tube de couleur. Les tubes protecteurs permettent un nettoyage simple.

Protection des tubes fluorescents

La protection des tubes fluorescents est mise en oeuvre de plus en plus souvent pour éviter des possibles accidents. Les Bulletins Officiels de l'Etat Espagnol indique : “Les éléments d'éclairage seront accompagnés de dispositifs qui vont protéger les aliments d'une possible contamination s'il existe une rupture.”

Pour ces motifs, la protection des tubes fluorescents est :

- OBLIGATOIRE dans les établissements du secteur de l'alimentation, comme par exemple : industrie de la viande, boucheries, charcuterie, cuisines et préparation d'alimentation, locaux de manipulation et vente de poisson, etc.
- TRÈS RECOMMANDABLE dans des bâtiments publics comme : les gares de train, écoles, parcs d'attractions, grands magasins, hôtels, restaurants, etc.

4.4

Iluminación técnica / Luminarias hospitalarias

Technical lighting / Clinic luminaires

Éclairage technique / Éclairage d'hôpital

**ES**

El modelo Sanium posee un diseño funcional para la iluminación de habitaciones de hospital.

Incluye avisador de enfermera, base Schuko, interruptores para luz de lectura y luz de reconocimiento y conmutador para luz ambiente.

El modelo Sanium ofrece la posibilidad de modificar su diseño adaptándose a las necesidades de cada cliente.

Características generales

- Luminaria: Aluminio extrusionado.
- Reflector: Aluminio lacado en blanco.
- Difusor: Policarbonato.

EN

The Sanium is a functional model designed for lighting hospital rooms.

It includes a nurse call button, Schuko plug, switches for reading and examination lights and switch for background light.

The Sanium's design can be adapted to meet the needs of each client.

General characteristics

- Light fitting body: Extruded aluminium.
- Reflector: Lacquered white steel.
- Diffuser: Polycarbonate.

FR

Le modèle Sanium possède une conception fonctionnelle pour l'éclairage de chambres d'hôpitaux et maisons de retraites.

Il inclue un appel d'infirmière, une prise de courant Schuko, interrupteurs pour lumière de lecture et lumière de reconnaissance et commutateur pour la lumière ambiante.

Le modèle Sanium offre la possibilité de modifier son dessin, pouvant être adapté aux besoins de chaque installation.

Caractéristiques générales

- Luminaire: Aluminium extrudé.
- Réflecteur: Aluminium laqué en blanc.
- Diffuseur: Polycarbonate.



Ficha técnica
Technical data
Fiche technique

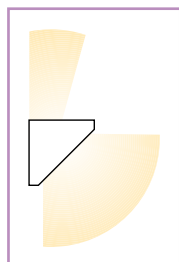

LED DISPONIBLE PARA LED
CONSULTAR PRECIO

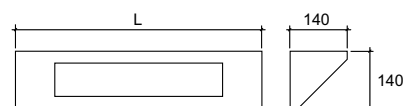

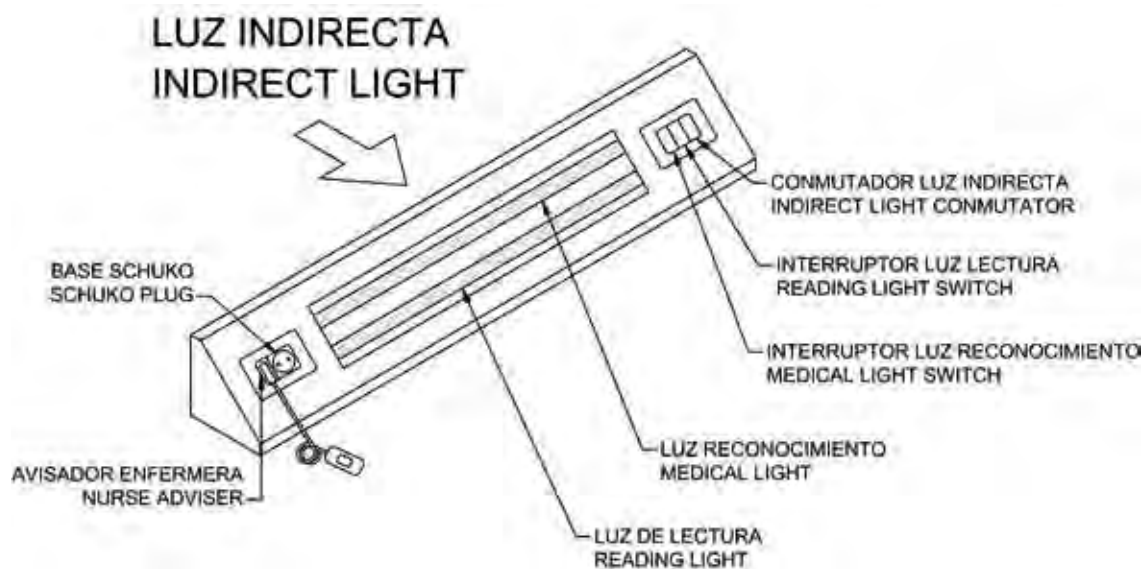

3 TUBOS FLUORESCENTES / 3 LAMPS / 3 LAMPES

Ref.	Potencia Watts Puissance	Equipo Equipment Ballast	Largo Length Longueur	Raee EU Recyclable tax Ecotaxe	Precio Price Prix
H318B	18 W	●	995	0,70 €	457,29 €
H318A	18 W	●	995	0,70 €	465,62 €
H336B	36 W	●	1.600	0,70 €	593,80 €
H336A	36 W	●	1.600	0,70 €	601,50 €
H358B	58 W	●	1.900	0,70 €	737,03 €
H358A	58 W	●	1.900	0,70 €	746,92 €

● Bajo factor / Low factor / Non-compensé

● Alto factor / High factor / Compensé

4.5

Iluminación técnica
Technical lighting
Éclairage technique

	Técnica Technical Technique
Accesos de pública concurrencia Crowded public access Accès publics à forte densité	MINIDELTA, DECO METALLIC
Aeropuertos / estaciones de tren, metro Airport / Railway station Aéroports / stations de train, métro	DECO, METALLIC SUPERDELTA
Agroalimentario Food industry Industrie agroalimentaire	TUBOS PROTECTORES
Aulas de enseñanza Classrooms Salles de classe	DECO, DELTA, METALLIC MINIDELTA, SUPERDELTA
Comercios y escaparates Shops and shop windows Commerces et vitrines	DELTA, SUPERDELTA MINIDELTA CARRIL ELECTRIFICADO
Iluminación portátil Portable lighting Éclairage portatif	EXTREME
Hospitales Hospitals Hôpitaux	SANIUM
Invernaderos Greenhouses Serres	TUBOS PROTECTORES
Naves industriales Warehouses Entrepôts industriels	LUMI DELTA 2 x 120 W
Oficinas Offices Bureaux	SUPERDELTA METALLIC, DECO
Supermercados Supermarkets Supermarchés	MINIDELTA, T. PROTECTORES SUPERDELTA, CARRIL ELECTRIFICADO
Zonas deportivas Sport areas Terrains de sport	DELTA



TR3

Biblioteca y archivo Histórico de Sant Fruitos de Bages, Barcelona, España
Library and Historic archive Sant Fruitos de Bages, Barcelona, Spain
Bibliothèque et archives Historique, Sant Fruitos de Bages, Barcelona, Espagne



ILUMINACIÓN RESIDENCIAL

RESIDENTIAL LIGHTING

ÉCLAIRAGE RÉSIDENTIEL

5.1	CYLINDRIC	214
5.2	CYLINDRIC+	216
5.3	MODELO 1 MODEL 1 MODÈLE 1	218
5.4	COBRA	222
5.5	NEVADA	228
5.6	MODELO X MODEL X MODÈLE X	234
5.7	VAN	239
5.8	F-40	240
5.9	F-328	244
5.10	SLIM	248
5.11	JOTA	250
5.12	DOWNLIGHT	252
5.13	Cuadro de aplicaciones Applications chart Tableau d'applications	258

5.1

Iluminación residencial

Residential lighting

Éclairage résidentiel

**ES**

Esta luminaria posee un grado de protección IP40 está pensada como elemento decorativo colgante para interiores, tales como:

- Espacios interiores en centros comerciales.
- Terrazas y espacios de ocio cerrados.
- Mobiliario interior.
- Puentes y pasarelas.
- Molduras y falsos techos.
- Patios interiores.
- Salones, salas de conferencias, salones de actos.
- Bares, restaurantes.

Otra gran ventaja de esta luminaria es su reducido diámetro, que permite instalarla en espacios muy reducidos.

Características generales

- Cuerpo luminaria: Policarbonato de 1 mm de espesor.
- Reflector: Sin reflector. Proyección lumínica 360°.
- Tapas finales: A.B.S.
- Temperatura de trabajo: De -15° C a +55° C.
- Ensayo hilo incandescente: 850° C.
- Accesorios: Tubo fluorescente tono 840 incluido. Cable de conexión incorporado con enchufe.

EN

This luminaire is IP40 protected, and it's designed as a decorative piece for indoor use. Some applications are:

- Indoor mall (commercial centers) use.
- Covered bar terrace.
- Indoor furniture.
- Plaster ceilings.
- Indoor halls.
- Showrooms, conference rooms.
- Restaurants, bars.

Very small diameter, that allows to install in narrow places.

General characteristics

- Light fitting body: 1 mm thickness polycarbonate.
- Reflector: Without reflector. 360° luminous flux.
- End caps: A.B.S.
- Working temperature: From -15° C to +55° C.
- Glow wire test: 850° C.
- Accessories: 840 tube fluorescent tube included. Wire with socket included.

FR

Ce luminaire a un degré de protection IP40, il est conçu comme un pendentif décoratif à l'intérieur, tels que:

- Intérieurs centres commerciales.
- Terrasses et lieux de divertissement fermée.
- Meubles d'intérieur.
- Les ponts et passerelles.
- Trim et plafonds.
- Terrasses.

- Les chambres conférence, réunion, salles de réception.
- Bars, restaurants.

Un autre grand avantage de cette lumière est son petit diamètre, ce qui permet une installation dans des espaces très confinés.

Caractéristiques générales

- Corps du luminaire: Polycarbonate de 1 mm de épaisseur.
- Réflecteur: Sans réflecteur. Projection de la lumière 360°.
- Embouts: A.B.S.
- Température d'utilisation: De -15° C à +55° C.
- Essai du fil incandescent: 850° C.
- Accessoires: Lampe couleur 840 inclus. Câble de connexion avec fiche incluse.



Ficha técnica
Technical data
Fiche technique

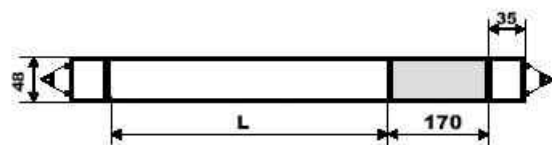

Las luminarias de policarbonato no soportan hidrocarburos

Polycarbonate light fittings don't allow hydrocarbons

Les luminaires de polycarbonate ne supportent pas les hydrocarbures

Ref.	Potencia Watts <i>Puissance</i>	Equipo Equipment <i>Ballast</i>	Largo Length <i>Longueur</i>	Raee EU Recyclable tax <i>Ecotaxe</i>	Precio Price <i>Prix</i>
Alta Eficacia / High Efficiency / Haute Efficacité					
C0501	14 W	●	550	0,25 €	110,53 €
C0502	21 W	●	850	0,25 €	111,22 €
Alto Rendimiento / High Output / Flux Élevé					
C0503	24 W	●	550	0,25 €	110,53 €

● Electrónica / Electronic / Électronique

ACCESORIOS / ACCESSORIES / ACCESSOIRES

REF. C0504

11,07 €



Suspensión con cable de acero
Steel cable suspension
Suspension avec câble en acier

5.2

Iluminación residencial

Residential lighting

Éclairage résidentiel

**ES**

Esta luminaria posee un grado de protección IP67 está pensada como elemento decorativo colgante para interiores, tales como:

- Espacios interiores en centros comerciales.
- Terrazas y espacios de ocio cerrados.
- Mobiliario interior.
- Puentes y pasarelas.
- Molduras y falsos techos.
- Patios interiores.
- Salones, salas de conferencias, salones de actos.
- Bares, restaurantes.

Características generales

- Cuerpo luminaria: Policarbonato opal de 1 mm de espesor.
- Reflector: Reflector aluminio espejular. Proyección lumínica 360°.
- Tapas finales: A.B.S.
- Temperatura de trabajo: De -20° C a +55° C.
- Tensión de alimentación: 220-240 V, 50-60 Hz. (electrónica).
- Ensayo hilo incandescente: 850° C.
- Accesorios: Dos tubos fluorescentes tono 840 incluidos. Una tapa sellada.

EN

This luminaire has a degree of protection of IP67 offering total protection against dust and against the penetration of water in immersion.

This waterproof decorative luminaire is suitable for:

- Indoor mall (commercial centers) use.
- Covered bar terrace.
- Indoor furniture.
- Plaster ceilings.
- Indoor halls.
- Showrooms, conference rooms.
- Restaurants, bars.

General characteristics

- Light fitting body: 1 mm thickness opal polycarbonate.
- Reflector: Glossy aluminium two sides. 360° luminous flux.
- End caps: A.B.S.
- Working temperature: From -20° C to +55° C.
- Voltage: 220-240 V, 50-60 Hz. (electronic ballast).
- Glow wire test: 850° C.
- Accessories: Two 840 tone fluorescent tubes included. One lap sealed.

FR

Ce luminaire a un degré de protection IP67, il est conçu comme un pendentif décoratif à l'intérieur, tels que:

- Intérieurs centres commerciales.
- Terrasses et lieux de divertissement fermée.
- Meubles d'intérieur.
- Les ponts et passerelles.
- Trim et plafonds.
- Terrasses.
- Les chambres conférence, réunion, salles de réception.
- Bars, restaurants.

Caractéristiques générales

- Corps du luminaire: Polycarbonate de 1 mm de épaisseur.
- Réflecteur: Sans réflecteur. Projection de la lumière 360°.
- Embouts: A.B.S.
- Température d'utilisation: De -20° C à +55° C.
- Essai du fil incandescent: 850° C.
- Accessoires: Lampe couleur 840 inclus. Fiche incluse.



Ficha técnica
Technical data
Fiche technique



DISPONIBLE PARA LED
CONSULTAR PRECIO

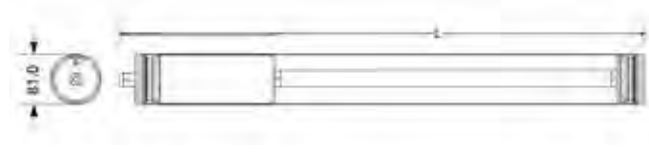

Las luminarias de policarbonato no soportan hidrocarburos

Polycarbonate light fittings don't allow hydrocarbons

Les luminaires de polycarbonate ne supportent pas les hydrocarbures

Ref.	Potencia Watts <i>Puissance</i>	Equipo Equipment <i>Ballast</i>	Largo Length <i>Longueur</i>	Raee EU Recyclable tax <i>Ecotaxe</i>	Precio Price <i>Prix</i>
C0505	18 W	●	1.313	0,50 €	133,92 €
C0506	36 W	●	1.923	0,50 €	152,13 €
C0507	58 W	●	2.228	0,50 €	171,85 €

● Electrónica / *Electronic / Électronique*

Ref.	Potencia Watts <i>Puissance</i>	Equipo Equipment <i>Ballast</i>	Largo Length <i>Longueur</i>	Raee EU Recyclable tax <i>Ecotaxe</i>	Precio Price <i>Prix</i>
Alta Eficacia / High Efficiency / Haute Efficacité					
C0508	14 W	●	1.275	0,50 €	134,52
C0509	21 W	●	1.570	0,50 €	145,06
C0510	28 W	●	1.876	0,50 €	154,29
C0511	35 W	●	2.178	0,50 €	164,79
Alto Rendimiento / High Output / Flux Élevé					
C0512	24 W	●	1.275	0,50 €	134,52
C0513	39 W	●	1.570	0,50 €	144,14
C0514	49 W	●	2.178	0,50 €	164,79
C0515	54 W	●	1.876	0,50 €	154,29
C0516	80 W	●	2.178	0,50 €	188,06

● Electrónica / *Electronic / Électronique*

ACCESORIOS / ACCESSORIES / ACCESSOIRES

REF. C0504

11,07 €



Suspensión con cable de acero
Steel cable suspension
Suspension avec câble en acier



5.3

Iluminación residencial Residential lighting Éclairage résidentiel



CON REFLECTOR
WITH REFLECTOR
AVEC RÉFLECTEUR

ES

Luminaria monolámpara de fácil instalación y amplias posibilidades decorativas.

Sus dimensiones y la posibilidad de instalación tanto por separado como formando las más variadas figuras, hace que este modelo sea apropiado para iluminar cualquier lugar donde sea necesaria una luminaria de reducido tamaño.

Disponible la versión en Clase II.

Características generales

- Cuerpo luminaria: Aluminio extrusionado.
- Reflector: Aluminio brillante (incluido).
- Difusor: Policarbonato (opcional).
- Tapas finales: A.B.S.
- Temperatura de trabajo: De -20° C a +45° C.

EN

This monolamp light fitting is easy to install and has great decorative possibilities.

Its dimensions and the option of installing it separately or forming different shapes, makes this model suitable for lighting any place where a small light fitting is necessary.

Available Class II light fitting.

General characteristics

- Light fitting body: Extruded aluminium.
- Reflector: Glossy aluminum (included).
- Diffuser: Polycarbonate (optional).
- End caps: A.B.S.
- Working temperature: From -20° C to +45° C.

FR

Luminaire de simple installation avec des grandes possibilités décoratives. Ses dimensions et la possibilité de l'installer seule ou en formant des diverses figures, font que ce modèle soit l'idéal pour éclairer différentes localisations où il soit nécessaire un luminaire d'une taille réduite.

Disponible une version en Classe II.

Caractéristiques générales

- Corps du luminaire: Aluminium extrudé.
- Réflecteur: Aluminium brillant (inclue).
- Diffuseur: Polycarbonate (optionnel).
- Embouts: A.B.S.
- Température d'utilisation: De -20° C à +45° C.

Color Colour Couleur	Ral.	Ref.
	6018	V
	9010	B
	1021	A
	3000	R
	9011	N
	9006	G

Disponible en los siguientes colores:
Ref luminaria + ref color. Ej.: A005V

Available in the different colours:
Light fitting ref + ref colour. Ex.: A005V

Disponible dans les suivantes couleurs:
Ref luminaire + ref couleur. Ej.: A005V



Ficha técnica
Technical data
Fiche technique



DISPONIBLE PARA LED
CONSULTAR PRECIO

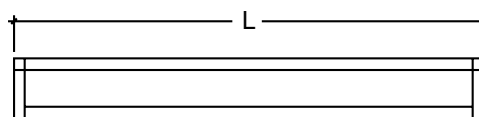
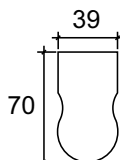

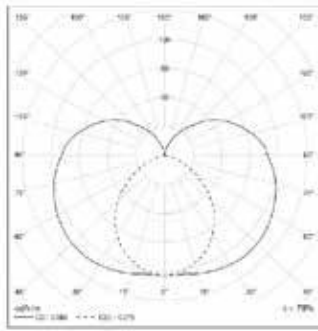

- Alto factor / High factor / Compensé
- Electrónica / Electronic / Électronique
- Regulable / Dimmable / Gradable

Ref.	Potencia Watts Puissance	Equipo Equipment Ballast	Largo Length Longueur	Raee EU Recyclable tax Ecotaxe	Precio Price Prix
A005	15 W	●	506	0,50 €	37,83 €
A013	18 W	●	658	0,50 €	39,79 €
A112	18 W	●	658	0,50 €	43,34 €
A136	18 W	●	658	0,50 €	83,34 €
A029	30 W	●	962	0,50 €	45,13 €
A037	36 W	●	1.266	0,50 €	50,07 €
A116	36 W	●	1.266	0,50 €	50,11 €
A140	36 W	●	1.266	0,50 €	90,11 €
A045	58 W	●	1.566	0,50 €	76,20 €
A120	58 W	●	1.566	0,50 €	54,44 €
A144	58 W	●	1.566	0,50 €	94,44 €

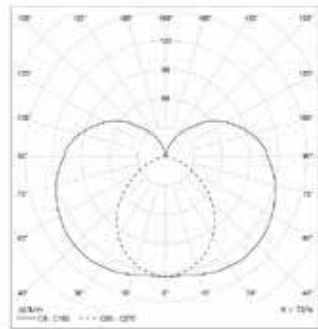

- Electrónica / Electronic / Électronique
- Regulable / Dimmable / Gradable

Ref.	Potencia Watts Puissance	Equipo Equipment Ballast	Largo Length Longueur	Raee EU Recyclable tax Ecotaxe	Precio Price Prix
Alta Eficacia / High Efficiency / Haute Efficacité					
A163	14 W	●	579	0,50 €	42,76 €
A169	14 W	●	579	0,50 €	82,43 €
A164	21 W	●	879	0,50 €	47,12 €
A170	21 W	●	879	0,50 €	86,74 €
A165	28 W	●	1.179	0,50 €	51,52 €
A171	28 W	●	1.179	0,50 €	91,52 €
A166	35 W	●	1.479	0,50 €	55,92 €
A172	35 W	●	1.479	0,50 €	95,92 €
Alto Rendimiento / High Output / Flux Élevé					
A167	39 W	●	879	0,50 €	48,18 €
A173	39 W	●	879	0,50 €	88,18 €
A168	54 W	●	1.179	0,50 €	54,16 €
A174	54 W	●	1.179	0,50 €	94,16 €

CLASE II / CLASS II / CLASSE II



Modelo / Model / Modèle	Ref.	Precio / Price / Prix
Conversión Clase II / Class II conversion	A6000	28,00 €

Según la norma EN 60598 sobre luminarias, las luminarias de clase II son aquellas en las que la protección contra los choques eléctricos no recae únicamente sobre el aislamiento principal, sino que comprende medidas de seguridad suplementarias, tales como el doble aislamiento reforzado de todos los componentes (reactancia, ficha, cable, portalámparas, cebador y portacebador). Estas medidas no comprenden medios de puesta a tierra como protección y no dependen de las condiciones de instalación.

According to the EN 60598 standard regarding light fittings, class II light fittings are those in which protection against electric shocks does not only consist of principal isolation, but also, supplementary double isolation security measures, in all components (ballast, terminal, block, cable, lampholder, starter and starterholder). These safety measures do not include grounding as a protection method and are not dependent on installation.

D'après la norme EN 60598, les luminaires de classe II sont celles où la protection contre les chocs électriques n'est pas supportée uniquement par l'isolement principal, car ils ont des mesures de sécurité supplémentaires, comme par exemple un double isolement renforcé de tout les composants (ballast, fiche de connexion, câbles, porte lampes, starters, et porte starters). Ces mesures n'incluent pas les composants de mise à terre comme protection et ne dépendent pas de l'installation.

5.3

Iluminación residencial
Residential lighting
Éclairage résidentiel

ACCESORIOS / ACCESSORIES / ACCESSOIRES



Difusor
Diffuser
Diffuseur

T8			T5		
Mod.	Ref.	€	Mod.	Ref.	€
15 W	A0540	2,62 €	14 W	A1570	3,25 €
18 W	A0550	3,86 €	21 W	A1580	5,16 €
30 W	A0570	5,39 €	28 W	A1590	7,07 €
36 W	A0580	7,86 €	35 W	A1600	8,98 €
58 W	A0590	9,82 €	39 W	A1610	5,16 €
			54 W	A1620	7,07 €

Disponible en los siguientes colores:
Ref luminaria + ref color. Ej.: A086B
Available in the different colours:
Light fitting ref + ref colour. Ex.: A086B
Disponible dans les suivantes couleurs:
Ref luminaire + ref couleur. Ej.: A086B

Color Colour Couleur	Ral.	Ref.
	9010	B
	9011	N



Enchufe / Interruptor / Soporte giratorio
Socket / Switch / Revolving Support

Prise de courant / Interrupteur / Support tournant

	Ref.	€
Interruptor Switch Interrupteur	A086	5,42 €
Enchufe Socket Prise de courant	A148	10,79 €
Soporte giratorio Revolving support Support tournant	A111	4,47 €

REF. A050

1,62 €



Adaptador línea continua
Continuity adapter
Adaptateur ligne continue

REF. A051

1,95 €



Adaptador ángulo
Angle adapter
Adaptateur angle

REF. A052

2,11 €



Adaptador "T"
"T" adapter
Adaptateur "T"

REF. A053

2,23 €



Adaptador "X"
"X" adapter
Adaptateur "X"

ACCESORIOS SUSPENSIÓN
SUSPENSION ACCESSORIES
ACCESSOIRES DE SUSPENSION



Cuerpo superior
Upper body
Corps supérieur

T8			T5		
Mod.	Ref.	€	Mod.	Ref.	€
15 W	A098	8,73 €	14 W	A175	8,73 €
18 W	A099	8,73 €	21 W	A176	17,74 €
30 W	A101	17,74 €	28 W	A177	17,74 €
36 W	A102	17,74 €	35 W	A178	22,14 €
58 W	A103	22,14 €	39 W	A179	17,74 €
			54 W	A180	17,74 €



REF. A0970

5,54 €



Adaptador cuerpo superior
Upper body adapter
Adaptateur corps supérieur

REF. A087

7,54 €



Adaptador superior final
Final upper adapter
Adaptateur supérieur final

REF. A089

13,42 €



Adaptador superior continuo
Continuous upper adapter
Adaptateur supérieur continue

REF. A091

13,98 €



Adaptador superior ángulo
Angle upper adapter
Adaptateur supérieur angle

REF. A093

19,23 €



Adaptador superior "T"
"T" upper adapter
Adaptateur supérieur "T"

REF. A095

24,69 €



Adaptador superior "X"
"X" upper adapter
Adaptateur supérieur "X"

REF. A104

6,80 €



Cable de acero
Steel cable
Câble en acier

REF. A109

28,22 €



Suspensiones extensibles
Extendable suspensions
Suspensions extensibles



Tija de tubo
Tube stem
Tige de tube

	Ref.	€
Tija 250 mm Stem 250 mm Tige 250 mm	A105	6,27 €
Tija 500 mm Stem 500 mm Tige 500 mm	A106	9,18 €
Tija 1000 mm Stem 1000 mm Tige 1000 mm	A107	12,82 €
Tija 1500 mm Stem 1500 mm Tige 1500 mm	A108	21,65 €

5.4

Iluminación residencial Residential lighting Éclairage résidentiel



CON REFLECTOR
WITH REFLECTOR
AVEC RÉFLECTEUR

ES

Modelo de luminaria bilámpara, con la que se consigue optimizar la formación de líneas continuas al minimizar el espacio entre fluorescentes.

Características generales

- Cuerpo luminaria: Aluminio lacado.
- Reflector: Aluminio brillante (incluido).
- Difusor: Policarbonato (opcional).
- Lama: Policarbonato (opcional).
- Tapas finales: A.B.S.
- Temperatura de trabajo: De -15° C a +45° C.

EN

Two lamp light fitting in which we have optimised the formation of continuous lines, by minimising the space between lamps.

General characteristics

- Light fitting body: Extruded aluminium.
- Reflector: Glossy aluminium (included).
- Diffuser: Polycarbonate (optional).
- Louvre: Polycarbonate (optional).
- End caps: A.B.S.
- Working temperature: From -15° C to +45° C.

FR

Modèle de luminaire, avec lequel on réussit optimiser la formation de lignes continues en minimisant l'espace entre fluorescents.

Caractéristiques générales

- Corps du luminaire: Aluminium laqué.
- Réflecteur: Aluminium brillant (inclus).
- Diffuseur: Polycarbonate (optionnel).
- Grille: Polycarbonate (optionnel).
- Embouts: A.B.S.
- Température d'utilisation: De -15° C à +45° C.

Color Colour Couleur	Ral.	Ref.
	6018	V
	9010	B
	1021	A
	3000	R
	9011	N
	9006	G

Disponible en los siguientes colores:
Ref luminaria + ref color. Ej.: C057V

Available in the different colours:
Light fitting ref + ref colour. Ex.: C057V

Disponible dans les suivantes couleurs:
Ref luminaire + ref couleur. Ej.: C057V



Ficha técnica
Technical data
Fiche technique



DISPONIBLE PARA LED
CONSULTAR PRECIO

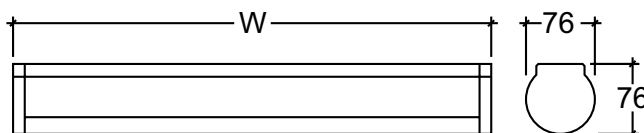

1 TUBO FLUORESCENTE / 1 LAMP / 1 LAMPE

G 13
T8

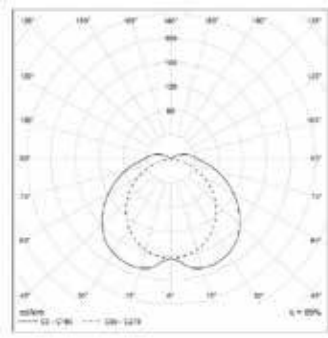

Ref.	Potencia Watts Puissance	Equipo Equipment Ballast	Largo Length Longueur	Raee EU Recyclable tax Ecotaxe	Precio Price Prix
C057	15 W	●	473	0,50 €	33,15 €
C061	18 W	●	623	0,50 €	36,86 €
C176	18 W	●	623	0,50 €	51,46 €
C197	18 W	●	623	0,50 €	91,46 €
C069	30 W	●	927	0,50 €	44,67 €
C073	36 W	●	1.232	0,50 €	51,92 €
C180	36 W	●	1.232	0,50 €	63,97 €
C198	36 W	●	1.232	0,50 €	103,97 €
C077	58 W	●	1.533	0,50 €	62,83 €
C184	58 W	●	1.533	0,50 €	70,45 €
C199	58 W	●	1.533	0,50 €	110,45 €

- Alto factor / High factor / Compensé
- Electrónica / Electronic / Électronique
- Regulable / Dimmable / Gradable

2 TUBOS FLUORESCENTES / 2 LAMPS / 2 LAMPES

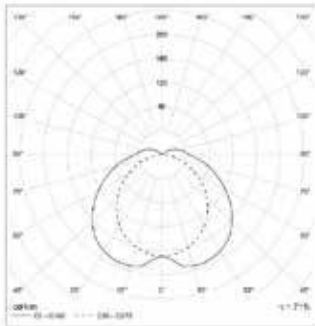

Ref.	Potencia Watts Puissance	Equipo Equipment Ballast	Largo Length Longueur	Raee EU Recyclable tax Ecotaxe	Precio Price Prix
C081	15 W	●	473	0,50 €	47,49 €
C085	18 W	●	623	0,50 €	51,19 €
C196	18 W	●	623	0,25 €	54,64 €
C200	18 W	●	623	0,25 €	94,64 €
C093	30 W	●	927	0,50 €	59,30 €
C097	36 W	●	1.232	0,50 €	66,59 €
C188	36 W	●	1.232	0,50 €	68,48 €
C201	36 W	●	1.232	0,50 €	108,48 €
C101	58 W	●	1.533	0,50 €	80,97 €
C192	58 W	●	1.533	0,50 €	75,17 €
C202	58 W	●	1.533	0,50 €	115,17 €

- Alto factor / High factor / Compensé
- Electrónica / Electronic / Électronique
- Regulable / Dimmable / Gradable

5.4

Iluminación residencial Residential lighting Éclairage résidentiel

1 TUBO FLUORESCENTE / 1 LAMP / 1 LAMPE

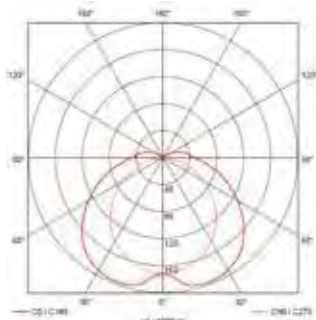
 G5
T5

- Electrónica / Electronic / Électronique
- Regulable / Dimmable / Gradable

Ref.	Potencia Watts Puissance	Equipo Equipment Ballast	Largo Length Longueur	Raee EU Recyclable tax Ecotaxe	Precio Price Prix
Alta Eficacia / High Efficiency / Haute Efficacité					
C203	14 W	●	579	0,50 €	47,10 €
C215	14 W	●	579	0,50 €	87,10 €
C204	21 W	●	879	0,50 €	54,05 €
C216	21 W	●	879	0,50 €	94,05 €
C205	28 W	●	1.179	0,50 €	64,66 €
C217	28 W	●	1.179	0,50 €	104,66 €
C206	35 W	●	1.479	0,50 €	71,85 €
C218	35 W	●	1.479	0,50 €	111,85 €
Alto Rendimiento / High Output / Flux Élevé					
C207	39 W	●	879	0,50 €	59,51 €
C219	39 W	●	879	0,50 €	99,51 €
C208	54 W	●	1.179	0,50 €	67,71 €
C220	54 W	●	1.179	0,50 €	107,71 €

2 TUBOS FLUORESCENTES / 2 LAMPS / 2 LAMPES

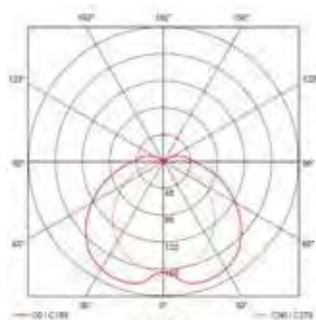

- Electrónica / Electronic / Électronique
- Regulable / Dimmable / Gradable

Ref.	Potencia Watts Puissance	Equipo Equipment Ballast	Largo Length Longueur	Raee EU Recyclable tax Ecotaxe	Precio Price Prix
Alta Eficacia / High Efficiency / Haute Efficacité					
C209	14 W	●	579	0,50 €	57,12 €
C221	14 W	●	579	0,50 €	97,12 €
C210	21 W	●	879	0,50 €	65,20 €
C222	21 W	●	879	0,50 €	105,20 €
C211	28 W	●	1.179	0,50 €	72,12 €
C223	28 W	●	1.179	0,50 €	112,12 €
C212	35 W	●	1.479	0,50 €	79,25 €
C224	35 W	●	1.479	0,50 €	119,25 €
Alto Rendimiento / High Output / Flux Élevé					
C213	39 W	●	879	0,50 €	63,72 €
C225	39 W	●	879	0,50 €	103,72 €
C214	54 W	●	1.179	0,50 €	71,51 €
C226	54 W	●	1.179	0,50 €	111,51 €

1 LÁMPARA / 1 LAMP / 1 LAMPE



- Bajo factor / Low factor / Non-compensé

Ref.	Potencia Watts Puissance	Equipo Equipment Ballast	Largo Length Longueur	Raee EU Recyclable tax Ecotaxe	Precio Price Prix
C113	5-7-9 W	●	220	0,25 €	21,69 €
C116	11 W	●	290	0,25 €	24,30 €
C117	18 W	●	290	0,50 €	27,10 €
C118	24 W	●	360	0,50 €	29,84 €
C119	36 W	●	470	0,50 €	32,04 €

ACCESORIOS / ACCESSORIES / ACCESSOIRES



Difusor
Diffuser
Diffuseur

T8			T5		
Mod.	Ref.	€	Mod.	Ref.	€
15 W	C1240	3,81 €	14 W	C2360	5,21 €
18 W	C1250	5,10 €	21 W	C2370	7,55 €
30 W	C1270	7,55 €	28 W	C2380	10,59 €
36 W	C1280	10,59 €	35 W	C2390	13,23 €
58 W	C1290	13,23 €	39 W	C2400	7,55 €
			54 W	C2410	10,59 €



Lama
Louvre
Grilles

T8			T5		
Mod.	Ref.	€	Mod.	Ref.	€
15 W	C1360	2,64 €	14 W	C2420	2,64 €
18 W	C1370	2,64 €	21 W	C2430	3,97 €
30 W	C1390	3,97 €	28 W	C2440	5,33 €
36 W	C1400	5,33 €	35 W	C2450	6,69 €
58 W	C1410	6,69 €	39 W	C2460	3,97 €
			54 W	C2470	5,33 €



Perfil-Tapa
Profile-Cap
Profil-Couvercle

Cm.	Ref.	€
Perfil / Profile	CPCO	0,31 €
Tapa / Cap	CTCO	0,13 €

Posibilidad de sujeción a carril "DELTA"
Accesorio: 2 uds. M0088 por luminaria

Possibility of mounting rail "DELTA"
Accessories: 2 uts. M0088 per fixture

Possibilité de fixation au rail "DELTA"
Accessoire: 2 uts. M0088 par luminaire

ACCESORIOS DE UNIÓN / JOINT ACCESSORIES / ACCESSOIRES D'UNION

Disponible en los siguientes colores:
Ref luminaria + ref color. Ej.: C120B

Available in the different colours:
Light fitting ref + ref colour. Ex.: C120B

Disponible dans les suivantes couleurs:
Ref luminaire + ref couleur. Ej.: C120B

Color Colour Couleur	Ral.	Ref.
	9010	B
	9011	N

REF. C120

1,65 €



Adaptador línea continua
Continuity adapter
Adaptateur ligne continue

REF. C121

2,88 €



Adaptador ángulo
Angle adapter
Adaptateur angle

REF. C122

3,90 €



Adaptador "T"
"T" adapter
Adaptateur "T"

REF. C123

3,93 €



Adaptador "X"
"X" adapter
Adaptateur "X"

5.4

Iluminación residencial Residential lighting Éclairage résidentiel

ACCESORIOS SUSPENSIÓN SUSPENSION ACCESSORIES ACCESSOIRES DE SUSPENSION

REF. C144

8,57 €



Adaptador superior final
Final upper adapter
Adaptateur supérieur final

REF. C146

7,66 €



Adaptador superior continuo
Continuous upper adapter
Adaptateur supérieur continue

REF. C148

9,42 €



Adaptador superior angular
Angle upper adapter
Adaptateur supérieur angle

REF. C150

7,58 €



Adaptador superior "T"
"T" upper adapter
Adaptateur supérieur "T"

REF. C152

8,72 €



Adaptador superior "X"
"X" upper adapter
Adaptateur supérieur "X"



Cuerpo superior
Upper body
Corps supérieur

T8			T5		
Mod.	Ref.	€	Mod.	Ref.	€
15 W	C154	4,50 €	14 W	C248	4,50 €
18 W	C155	4,50 €	21 W	C249	4,50 €
30 W	C157	9,31 €	28 W	C250	9,31 €
36 W	C158	9,31 €	35 W	C251	11,68 €
58 W	C159	11,68 €	39 W	C252	9,31 €
			54 W	C253	9,31 €



REF. C164



6,80 €

Cable de acero 1900 mm
Steel cable 1900 mm
Câble en acier 1900 mm

REF. C165



28,22 €

Suspensiones extensibles 400 mm
Extendable suspensions 400 mm
Suspensions extensibles 400 mm

REF. C143



5,22 €

Soporte giratorio
Revolving support
Support tournant



Tija de tubo
Tube stem
Tige de tube

	Ref.	€
Tija 250 mm Stem 250 mm Tige 250 mm	C160	6,27 €
Tija 500 mm Stem 500 mm Tige 500 mm	C161	9,18 €
Tija 1000 mm Stem 1000 mm Tige 1000 mm	C162	12,82 €
Tija 1500 mm Stem 1500 mm Tige 1500 mm	C163	21,65 €

5.5

Iluminación residencial

Residential lighting

Éclairage résidentiel



CON REFLECTOR
WITH REFLECTOR
AVEC RÉFLECTEUR

ES

El modelo Nevada ofrece las uniones articuladas, con un máximo de 6 derivaciones orientables en cualquier dirección. De este modo se obtienen infinidad de formas y figuras, integrándose con facilidad en el diseño de cualquier espacio.

Características generales

- Cuerpo luminaria: Aluminio lacado.
- Reflector: Aluminio brillante (incluido).
- Difusor: Policarbonato (opcional).
- Lama: Policarbonato (opcional).
- Tapas finales: A.B.S.

EN

The Nevada model offers articulated joints with up to 6 branches, which can be placed in any direction. In this way you can create an infinite variety of forms and shapes that integrate easily into the design of any space.

General characteristics

- Light fitting body: Extruded aluminium.
- Reflector: Glossy aluminium (included).
- Diffuser: Polycarbonate (optional).
- Louvre: Polycarbonate (optional).
- End caps: A.B.S.

FR

Le modèle Nevada offre des unions articulées avec un maximum de 6 dérives orientables dans n'importe quelle direction. De cette façon on obtient une infinité de formes et figures, pouvant être facilement intégrées sur tous les espaces.

Caractéristiques générales

- Corps du luminaire: Aluminium laqué.
- Réflecteur: Aluminium brillant (inclus).
- Diffuseur: Polycarbonate (optionnel).
- Grille: Polycarbonate (optionnel).
- Embouts: A.B.S.

Color Colour Couleur	Ral.	Ref.
	6018	V
	9010	B
	1021	A
	9011	N
	9006	G

Disponible en los siguientes colores:
Ref luminaria + ref color. Ej.: N057V

Available in the different colours:
Light fitting ref + ref colour. Ex.: N057V

Disponible dans les suivantes couleurs:
Ref luminaire + ref couleur. Ej.: N057V



Ficha técnica
Technical data
Fiche technique



DISPONIBLE PARA LED
CONSULTAR PRECIO

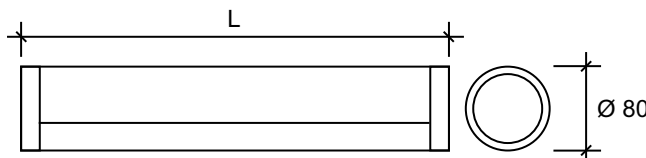

1 TUBO FLUORESCENTE / 1 LAMP / 1 LAMPE

G 13
T8

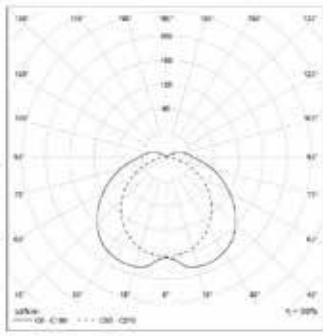

Ref.	Potencia Watts Puissance	Equipo Equipment Ballast	Largo Length Longueur	Raee EU Recyclable tax Ecotaxe	Precio Price Prix
N057	15 W	●	473	0,50 €	32,90 €
N061	18 W	●	623	0,50 €	37,80 €
N176	18 W	●	623	0,25 €	43,79 €
N155	18 W	●	623	0,25 €	83,79 €
N069	30 W	●	927	0,50 €	45,25 €
N073	36 W	●	1.232	0,50 €	53,41 €
N180	36 W	●	1.232	0,50 €	66,90 €
N156	36 W	●	1.232	0,50 €	106,90 €
N077	58 W	●	1.533	0,50 €	64,58 €
N184	58 W	●	1.533	0,50 €	74,03 €
N157	58 W	●	1.533	0,50 €	114,03 €

- Alto factor / High factor / Compensé
- Electrónica / Electronic / Electronique
- Regulable / Dimmable / Gradable

2 TUBOS FLUORESCENTES / 2 LAMPS / 2 LAMPES

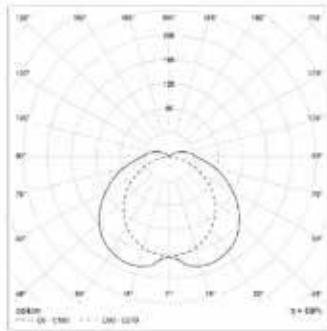

Ref.	Potencia Watts Puissance	Equipo Equipment Ballast	Largo Length Longueur	Raee EU Recyclable tax Ecotaxe	Precio Price Prix
N081	15 W	●	473	0,50 €	47,10 €
N085	18 W	●	623	0,50 €	52,53 €
N196	18 W	●	623	0,25 €	55,72 €
N164	18 W	●	623	0,25 €	95,72 €
N093	30 W	●	927	0,50 €	60,13 €
N097	36 W	●	1.232	0,50 €	68,98 €
N188	36 W	●	1.232	0,50 €	71,34 €
N165	36 W	●	1.232	0,50 €	111,34 €
N101	58 W	●	1.533	0,50 €	84,12 €
N192	58 W	●	1.533	0,50 €	79,40 €
N166	58 W	●	1.533	0,50 €	119,40 €

- Alto factor / High factor / Compensé
- Electrónica / Electronic / Électronique
- Regulable / Dimmable / Gradable

5.5

Iluminación residencial

Residential lighting

Éclairage résidentiel

1 TUBO FLUORESCENTE / 1 LAMP / 1 LAMPE

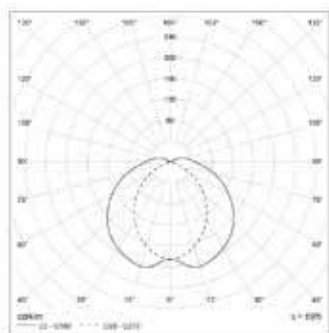
G5
T5

- Electrónica / Electronic / Électronique
- Regulable / Dimmable / Gradable

Ref.	Potencia Watts Puissance	Equipo Equipment Ballast	Largo Length Longueur	Raee EU Recyclable tax Ecotaxe	Precio Price Prix
Alta Eficacia / High Efficiency / Haute Efficacité					
N203	14 W	●	579	0,50 €	47,71 €
N215	14 W	●	579	0,50 €	87,71 €
N204	21 W	●	879	0,50 €	63,56 €
N216	21 W	●	879	0,50 €	103,56 €
N205	28 W	●	1.179	0,50 €	72,79 €
N217	28 W	●	1.179	0,50 €	112,79 €
N206	35 W	●	1.479	0,50 €	74,96 €
N218	35 W	●	1.479	0,50 €	114,96 €
Alto Rendimiento / High Output / Flux Élevé					
N207	39 W	●	879	0,50 €	61,58 €
N219	39 W	●	879	0,50 €	101,58 €
N208	54 W	●	1.179	0,50 €	83,61 €
N220	54 W	●	1.179	0,50 €	123,61 €

2 TUBOS FLUORESCENTES / 2 LAMPS / 2 LAMPES

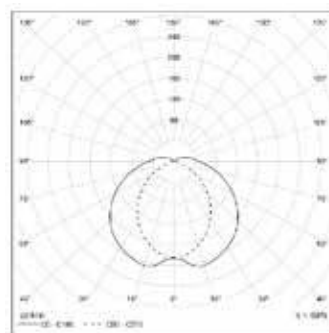

- Electrónica / Electronic / Électronique
- Regulable / Dimmable / Gradable

Ref.	Potencia Watts Puissance	Equipo Equipment Ballast	Largo Length Longueur	Raee EU Recyclable tax Ecotaxe	Precio Price Prix
Alta Eficacia / High Efficiency / Haute Efficacité					
N209	14 W	●	579	0,50 €	56,15 €
N221	14 W	●	579	0,50 €	96,15 €
N210	21 W	●	879	0,50 €	68,19 €
N222	21 W	●	879	0,50 €	108,19 €
N211	28 W	●	1.179	0,50 €	71,35 €
N223	28 W	●	1.179	0,50 €	111,35 €
N212	35 W	●	1.479	0,50 €	78,94 €
N224	35 W	●	1.479	0,50 €	118,94 €
Alto Rendimiento / High Output / Flux Élevé					
N213	39 W	●	879	0,50 €	66,64 €
N225	39 W	●	879	0,50 €	106,64 €
N214	54 W	●	1.179	0,50 €	73,42 €
N226	54 W	●	1.179	0,50 €	113,42 €

1 LÁMPARA / 1 LAMP / 1 LAMPE



Ref.	Potencia Watts Puissance	Equipo Equipment Ballast	Largo Length Longueur	Raee EU Recyclable tax Ecotaxe	Precio Price Prix
N113	5-7-9 W	●	220	0,25 €	22,04 €
N116	11 W	●	290	0,25 €	24,07 €
N117	18 W	●	290	0,50 €	27,39 €
N118	24 W	●	360	0,50 €	30,33 €
N119	36 W	●	470	0,50 €	32,56 €

- Bajo factor / Low factor / Non-compensé



Difusor
Diffuser
Diffuseur

T8			T5		
Mod.	Ref.	€	Mod.	Ref.	€
15 W	N1280	3,81 €	14 W	N2330	5,21 €
18 W	N1290	5,21 €	21 W	N2340	7,55 €
30 W	N1310	7,55 €	28 W	N2350	10,59 €
36 W	N1320	10,59 €	35 W	N2360	13,23 €
58 W	N1330	13,23 €	39 W	N2370	7,55 €
			54 W	N2380	10,38 €



Lama
Louvre
Grilles

T8			T5		
Mod.	Ref.	€	Mod.	Ref.	€
15 W	N1400	2,64 €	14 W	N2320	2,64 €
18 W	N1410	2,64 €	21 W	N2270	3,97 €
30 W	N1430	3,97 €	28 W	N2280	5,33 €
36 W	N1440	5,33 €	35 W	N2290	6,69 €
58 W	N1450	6,69 €	39 W	N2300	3,97 €
			54 W	N2310	5,29 €



Perfil-Tapa
Profile-Cap
Profil-Couvercle

Cm.	Ref.	€
Perfil / Profile	NPNO	0,32 €
Tapa / Cap	NTNO	0,13 €

ACCESORIOS SUSPENSIÓN
SUSPENSION ACCESSORIES
ACCESSOIRES DE SUSPENSION

REF. N153

9,60 €



Cable de acero 1900 mm
Steel cable 1900 mm
Câble en acier 1900 mm

REF. N154

31,03 €



Suspensiones extensibles 400 mm
Extendable suspensions 400 mm
Suspensions extensibles 400 mm

REF. N147

5,09 €



Soporte giratorio
Revolving support
Support tournant



Tija de tubo
Tube stem
Tige de tube

	Ref.	€
Tija 95 mm Stem 95 mm Tige 95 mm	N148	6,36 €
Tija 250 mm Stem 250 mm Tige 250 mm	N149	9,34 €
Tija 500 mm Stem 500 mm Tige 500 mm	N150	12,25 €
Tija 1000 mm Stem 1000 mm Tige 1000 mm	N151	15,89 €
Tija 1500 mm Stem 1500 mm Tige 1500 mm	N152	24,72 €



5.5

Iluminación residencial

Residential lighting



Éclairage résidentiel

ACCESORIOS DE UNIÓN / JOINT ACCESSORIES / ACCESSOIRES D'UNION

Disponible en los siguientes colores:
Ref luminaria + ref color. Ej.: N120B

Available in the different colours:
Light fitting ref + ref colour. Ex.: N120B

Disponible dans les suivantes couleurs:
Ref luminaire + ref couleur. Ej.: N120B

Color Colour Couleur	Ral.	Ref.
	9010	B
	9011	N

REF. N120

3,47 €



Adaptador línea continua
Continuity adapter
Adaptateur ligne continue

REF. N121

20,36 €



Unión articulada 2
Articulated joint 2
Union articulée 2

REF. N122

23,52 €



Unión articulada 3
Articulated joint 3
Union articulée 3

REF. N123

27,06 €



Unión articulada 4
Articulated joint 4
Union articulée 4

REF. N124

30,60 €



Unión articulada 5
Articulated joint 5
Union articulée 5

REF. N125

34,14 €



Unión articulada 6
Articulated joint 6
Union articulée 6

REF. N126

12,90 €



Disco central
Central disc
Disque central

REF. N127

3,54 €



Terminal derivación
Adapter for central disc
Terminale dérivation



NEVADA VERDE / GREEN / VERT

Frutería, Zaragoza, España

Greengrocer, Zaragoza, Spain

Marchand de légumes, Saragosse, Espagne



NEVADA VERDE / GREEN / VERT

Frutería, Zaragoza, España

Greengrocer, Zaragoza, Spain

Marchand de légumes, Saragosse, Espagne

5.6

Iluminación residencial
Residential lighting
Éclairage résidentiel



CON REFLECTOR
WITH REFLECTOR
AVEC RÉFLECTEUR

ES

Diseño en fluorescencia. La luminaria más vendida en tiendas de decoración y de diseño en iluminación.

Lo más atrevido e innovador: El modelo 2 lámparas TC-L volantes.

Características generales

- Cuerpo luminaria: Aluminio extrusionado.
- Reflector: Aluminio brillante (incluido).
- Difusor: Policarbonato (opcional).
- Lama: A.B.S. (opcional).
- Tapas finales: A.B.S.

EN

Fluorescent design. The best selling light fitting in furnishing and lighting shops.

The most daring and innovating: model 2 TC-L aerial lamps.

General characteristics

- Light fitting body: Extruded aluminium.
- Reflector: Glossy aluminium (included).
- Diffuser: Polycarbonate (optional).
- Louvre: A.B.S. (optional).
- End caps: A.B.S.

FR

Le design en fluorescence. Le luminaire le plus vendu dans les magasins d'éclairage et de design d'éclairage. Le modèle plus innovateur.

La version 2 lampes TC-L suspendues.

Caractéristiques générales.

- Corps du linaira : Aluminium laqué.
- Réflecteur : Auminium brillant (inclus).
- Diffuseur : Polycarbonate (optionnel).
- Grille: Polycarbonate (optionnel).
- Embouts : A.B.S.

Color Colour Couleur	Ral.	Ref.
	6018	V
	9010	B
	1021	A
	3000	R
	9011	N
	9006	G

Disponible en los siguientes colores:
Ref luminaria + ref color. Ej.: X057V

Available in the different colours:
Light fitting ref + ref colour. Ex.: X057V

Disponible dans les suivantes couleurs:
Ref luminaire + ref couleur. Ej.: X057V



Ficha técnica
Technical data
Fiche technique



DISPONIBLE PARA LED
CONSULTAR PRECIO

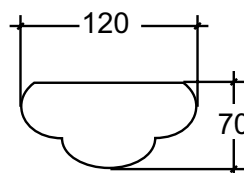

1 TUBO FLUORESCENTE / 1 LAMP / 1 LAMPE

G 13
T8



- Alto factor / High factor / Compensé
- Electrónica / Electronic / Électronique
- Regulable / Dimmable / Gradable

Ref.	Potencia Watts Puissance	Equipo Equipment Ballast	Largo Length Longueur	Raee EU Recyclable tax Ecotaxe	Precio Price Prix
X057	15 W	●	476	0,50 €	37,56 €
X061	18 W	●	628	0,50 €	43,31 €
X176	18 W	●	628	0,25 €	49,31 €
X155	18 W	●	628	0,25 €	89,31 €
X069	30 W	●	933	0,50 €	52,97 €
X073	36 W	●	1.238	0,50 €	64,38 €
X180	36 W	●	1.238	0,50 €	77,93 €
X156	36 W	●	1.238	0,50 €	117,93 €
X077	58 W	●	1.538	0,50 €	77,91 €
X184	58 W	●	1.538	0,50 €	87,67 €
X157	58 W	●	1.538	0,50 €	127,67 €

2 TUBOS FLUORESCENTES / 2 LAMPS / 2 LAMPES

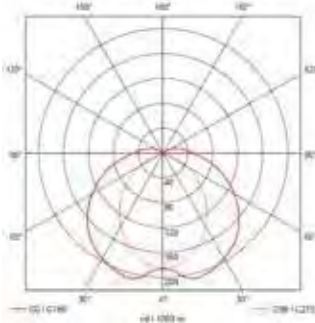

- Alto factor / High factor / Compensé
- Electrónica / Electronic / Électronique
- Regulable / Dimmable / Gradable

Ref.	Potencia Watts Puissance	Equipo Equipment Ballast	Largo Length Longueur	Raee EU Recyclable tax Ecotaxe	Precio Price Prix
X081	15 W	●	476	0,50 €	51,55 €
X085	18 W	●	628	0,50 €	57,57 €
X196	18 W	●	628	0,25 €	61,24 €
X164	18 W	●	628	0,25 €	101,24 €
X093	30 W	●	933	0,50 €	67,48 €
X097	36 W	●	1.238	0,50 €	79,46 €
X188	36 W	●	1.238	0,50 €	82,31 €
X165	36 W	●	1.238	0,50 €	122,31 €
X101	58 W	●	1.538	0,50 €	96,66 €
X192	58 W	●	1.538	0,50 €	92,17 €
X166	58 W	●	1.538	0,50 €	132,17 €

5.6

Iluminación residencial
Residential lighting
Éclairage résidentiel

1 TUBO FLUORESCENTE / 1 LAMP / 1 LAMPE

G5
T5

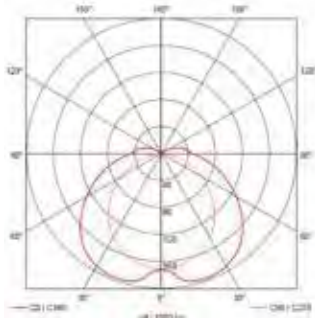

- Electrónica / Electronic / Électronique
- Regulable / Dimmable / Gradable

Ref.	Potencia Watts Puissance	Equipo Equipment Ballast	Largo Length Longueur	Raee EU Recyclable tax Ecotaxe	Precio Price Prix
Alta Eficacia / High Efficiency / Haute Efficacité					
X301	14 W	●	580	0,50 €	53,38 €
X201	14 W	●	580	0,50 €	93,38 €
X305	21 W	●	880	0,50 €	63,35 €
X202	21 W	●	880	0,50 €	103,35 €
X309	28 W	●	1.180	0,50 €	78,16 €
X203	28 W	●	1.180	0,50 €	118,16 €
X313	35 W	●	1.490	0,50 €	87,99 €
X204	35 W	●	1.490	0,50 €	127,99 €
Alto Rendimiento / High Output / Flux Élevé					
X317	39 W	●	880	0,50 €	72,59 €
X205	39 W	●	880	0,50 €	112,59 €
X321	54 W	●	1.180	0,50 €	81,60 €
X206	54 W	●	1.180	0,50 €	121,60 €

2 TUBOS FLUORESCENTES / 2 LAMPS / 2 LAMPES

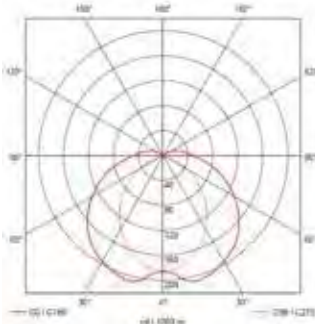

- Electrónica / Electronic / Électronique
- Regulable / Dimmable / Gradable

Ref.	Potencia Watts Puissance	Equipo Equipment Ballast	Largo Length Longueur	Raee EU Recyclable tax Ecotaxe	Precio Price Prix
Alta Eficacia / High Efficiency / Haute Efficacité					
X325	14 W	●	580	0,50 €	62,20 €
X207	14 W	●	580	0,50 €	102,20 €
X329	21 W	●	880	0,50 €	72,33 €
X208	21 W	●	880	0,50 €	112,33 €
X333	28 W	●	1.180	0,50 €	82,30 €
X209	28 W	●	1.180	0,50 €	122,30 €
X337	35 W	●	1.490	0,50 €	92,77 €
X210	35 W	●	1.490	0,50 €	132,77 €
Alto Rendimiento / High Output / Flux Élevé					
X341	39 W	●	880	0,50 €	73,96 €
X211	39 W	●	880	0,50 €	113,96 €
X345	54 W	●	1.180	0,50 €	83,97 €
X212	54 W	●	1.180	0,50 €	123,97 €

1 LÁMPARA / 1 LAMP / 1 LAMPE

2 GII
TC-L



CON REFLECTOR
WITH REFLECTOR
AVEC RÉFLECTEUR

- Alto factor / High factor / Compensé
- Electrónica / Electronic / Électronique
- Regulable / Dimmable / Gradable

Ref.	Potencia Watts Puissance	Equipo Equipment Ballast	Largo Length Longueur	Raee EU Recyclable tax Ecotaxe	Precio Price Prix
X425	18 W	●	265	0,50 €	35,98 €
X449	18 W	●	265	0,25 €	51,50 €
X461	18 W	●	265	0,25 €	91,50 €
X426	24 W	●	355	0,25 €	39,66 €
X450	24 W	●	355	0,25 €	54,05 €
X462	24 W	●	355	0,25 €	94,05 €
X427	36 W	●	455	0,50 €	43,28 €
X451	36 W	●	455	0,50 €	57,38 €
X463	36 W	●	455	0,50 €	97,38 €
X452	55 W	●	580	0,50 €	61,72 €
X464	55 W	●	580	0,50 €	101,72 €

2 LÁMPARAS CONTINUAS / 2 CONTINUOUS LAMPS / 2 LAMPES CONTINUES



CON REFLECTOR
WITH REFLECTOR
AVEC RÉFLECTEUR

- Alto factor / High factor / Compensé
- Electrónica / Electronic / Électronique
- Regulable / Dimmable / Gradable

Ref.	Potencia Watts Puissance	Equipo Equipment Ballast	Largo Length Longueur	Raee EU Recyclable tax Ecotaxe	Precio Price Prix
X536	18 W	●	520	0,50 €	62,62 €
X561	18 W	●	520	0,25 €	66,75 €
X573	18 W	●	520	0,25 €	102,62 €
X537	24 W	●	710	0,25 €	68,98 €
X562	24 W	●	710	0,25 €	80,23 €
X574	24 W	●	710	0,25 €	120,23 €
X543	36 W	●	900	0,50 €	75,92 €
X567	36 W	●	900	0,50 €	81,11 €
X575	36 W	●	900	0,50 €	121,11 €
X568	55 W	●	1.145	0,50 €	93,55 €
X576	55 W	●	1.145	0,50 €	133,55 €

2 LÁMPARAS / 2 LAMPS / 2 LAMPES SUSPENDUES



- Alto factor / High factor / Compensé
- Electrónica / Electronic / Électronique
- Regulable / Dimmable / Gradable

Ref.	Potencia Watts Puissance	Equipo Equipment Ballast	Largo Length Longueur	Raee EU Recyclable tax Ecotaxe	Precio Price Prix
X505	18 W	●	550	0,50 €	42,75 €
X509	18 W	●	550	0,25 €	64,34 €
X585	18 W	●	550	0,25 €	104,34 €
X506	24 W	●	670	0,25 €	67,46 €
X510	24 W	●	670	0,25 €	65,90 €
X586	24 W	●	670	0,25 €	105,90 €
X507	36 W	●	860	0,50 €	76,02 €
X511	36 W	●	860	0,50 €	80,38 €
X587	36 W	●	860	0,50 €	120,38 €
X512	55 W	●	1.180	0,50 €	102,43 €
X588	55 W	●	1.180	0,50 €	144,43 €

5.6

Iluminación residencial
Residential lighting
Éclairage résidentiel

ACCESORIOS / ACCESSORIES / ACCESSOIRES



Difusor
Diffuser
Diffuseur

T8			T5			Lámpara TCL		
Mod.	Ref.	€	Mod.	Ref.	€	Mod.	Ref.	€
15 W	X1280	3,81 €	14 W	X3800	5,21 €	1 X 18 W	X4800	3,81 €
18 W	X1290	5,20 €	21 W	X3810	7,55 €	1 X 24 W	X4810	3,81 €
30 W	X1310	7,55 €	28 W	X3820	10,59 €	1 X 36 W	X4820	3,81 €
36 W	X1320	10,58 €	35 W	X3830	12,97 €	1 X 55 W	X4830	5,21 €
58 W	X1330	13,22 €	39 W	X3840	7,55 €	2 X 18 W	X4900	5,21 €
			54 W	X3850	10,59 €	2 X 24 W	X4910	7,55 €
						2 X 36 W	X4920	7,55 €
						2 X 55 W	X4930	10,59 €



Lamas cromadas
Chrome louvre
Grilles chrome

T8			T5			Lámpara TCL		
Mod.	Ref.	€	Mod.	Ref.	€	Mod.	Ref.	€
15 W	X1400	5,32 €	14 W	X3860	5,32 €	1 X 18 W	X4860	2,66 €
18 W	X1410	5,32 €	21 W	X3870	7,98 €	1 X 24 W	X4870	5,32 €
30 W	X1430	7,98 €	28 W	X3880	10,68 €	1 X 36 W	X4880	5,32 €
36 W	X1440	10,68 €	35 W	X3890	13,37 €	1 X 55 W	X4890	5,32 €
58 W	X1450	13,37 €	39 W	X3900	7,98 €	2 X 18 W	X4940	5,32 €
			54 W	X3910	10,68 €	2 X 24 W	X4950	7,98 €
						2 X 36 W	X4960	7,98 €
						2 X 55 W	X4970	10,68 €

Disponible en los siguientes colores:
Ref luminaria + ref color. Ej.: X128V

Available in the different colours:
Light fitting ref + ref colour. Ex.: X128V

Disponible dans les suivantes couleurs:
Ref luminaire + ref couleur. Ej.: X128V

Color	Ral.	Ref.
Colour		
Couleur		
	9010	B
	9011	N

ACCESORIOS SUSPENSIÓN
SUSPENSION ACCESSORIES
ACCESSOIRES DE SUSPENSION

REF. X153

9,60 €



Cable de acero 1900 mm
Steel cable 1900 mm
Câble en acier 1900 mm

REF. X154

31,03 €



Suspensiones extensibles 400 mm
Extendable suspensions 400 mm
Suspensions extensibles 400 mm



Tija de tubo
Tube stem
Tige de tube

	Ref.	€
Tija 95 mm Stem 95 mm Tige 95 mm	X148	6,36 €
Tija 250 mm Stem 250 mm Tige 250 mm	X149	9,34 €
Tija 500 mm Stem 500 mm Tige 500 mm	X150	12,25 €
Tija 1000 mm Stem 1000 mm Tige 1000 mm	X151	15,89 €
Tija 1500 mm Stem 1500 mm Tige 1500 mm	X152	24,72 €

5.7

Iluminación residencial

Residential lighting

Éclairage résidentie



Clase II
Class II

**ES**

Luminaria de 12V ideal para automoción, paneles solares, embarcaciones, etc. Práctica y económica. Interruptor incorporado.

Características generales

- Luminaria: Policarbonato.
- Reflector: Aluminio lacado en blanco.
- Temperatura de trabajo: De 0° C a 45° C.

EN

12 V light fitting, ideal for automotive use, solar panels, vessels, etc. Practical and economical. Switch Boilt-W.

General characteristics

- Light fitting body: Polycarbonate.
- Reflector: Lacquered white aluminium.
- Working temperature: From 0° C to 45° C.

FR

Luminaire de 12 V, idéale pour les automobiles, panneau solaires, embarcations, etc. Utile et économique. Interrupteur incorporé.

Caractéristiques générales

- Luminaire: Polycarbonate.
- Réflecteur: Aluminium laqué en blanc.
- Température d'utilisation: De 0° C à 45° C.

TODAS LAS LUMINARIAS INCLUYEN TUBO FLUORESCENTE DE MUESTRA

THIS LIGHT FITTINGS INCLUDED GRATUITE TUBE

TOUS LES LUMINAIRES INCLUENT UNE LAMPE ÉCHANTILLON POUR VÉRIFIER SOU FOUNTIONEMENT

Ref.	Potencia Watts Puissance	Equipo Equipment Ballast	Largo Length Longueur	Raee EU Recyclable tax Ecotaxe	Precio Price Prix
IVAN8	8 W	12 V	465	0,25 €	30,32 €
IVAN3	13 W	12 V	695	0,25 €	36,04 €



Ficha técnica
Technical data
Fiche technique

5.8

Iluminación residencial

Residential lighting

Éclairage résidentiel

**ES**

El sistema de soporte para lámparas fluorescentes F-40 consiste en la unión de tubos electrificados con tubos pasacables, gracias a la cual se consigue una estructura sólida y funcional. Las principales aplicaciones de este modelo son para amplias exposiciones donde se requiere un alto nivel de iluminación.

Características generales

- Cuerpo luminaria: Aluminio extrusionado.
- Tubo pasacable: Aluminio.
- Tapas finales: A.B.S.

EN

The F-40 fluorescent light support system consists of the connection of electrified modules with cable tubes, creating a solid and functional structure. The main use for this model is in large exhibition areas where a high level of illumination is required.

General characteristics

- Light fitting body: Extruded aluminum.
- Wiring tube: Aluminum.
- End caps: A.B.S.

FR

Le système de support pour les tubes fluorescents F-40 consiste dans l'union des tubes électrifiés avec des tubes passe-fils, grâce à laquelle on réussit à avoir une structure solide et fonctionnelle. Les principales applications de ce modèle sont les amples expositions qui ont besoin d'un haut niveau d'éclairage.

Caractéristiques générales

- Corps du luminaire: Aluminium extrudé.
- Tube passe-fils: Aluminium.
- Embouts: A.B.S.



Ficha técnica
Technical data
Fiche technique

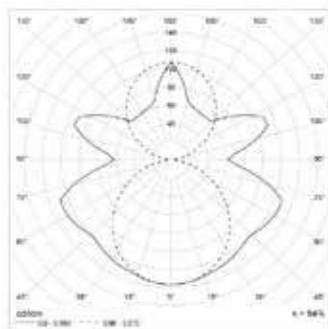

DISPONIBLE PARA LED
CONSULTAR PRECIO

MÓDULO FINAL
FINAL MODULE
MODULE FINAL

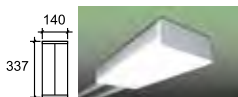

Mod.	Ref.	Raee*	€
-	F000	0,50 €	43,93 €



Mod.	Ref.	Raee*	€
2 X 15 W	F011	0,50 €	73,75 €
2 X 18 W	F012	0,50 €	75,58 €
2 X 30 W	F014	0,50 €	74,67 €
2 X 36 W	F015	0,50 €	75,70 €
2 X 58 W	F016	0,50 €	83,29 €

MÓDULO DE LÍNEA CONTINUA
CONTINUED LINE MODULE
MODULE DE LIGNE CONTINUE

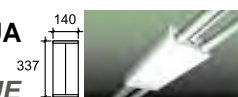

Mod.	Ref.	Raee*	€
-	F100	0,50 €	44,80 €



Mod.	Ref.	Raee*	€
2 X 15 W	F111	0,50 €	81,42 €
2 X 18 W	F112	0,50 €	82,94 €
2 X 30 W	F114	0,50 €	82,36 €
2 X 36 W	F115	0,50 €	83,40 €
2 X 58 W	F116	0,50 €	90,98 €

MÓDULO "T"
"T" MODULE
MODULE "T"

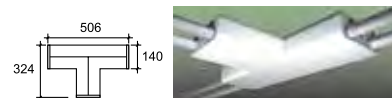

Mod.	Ref.	Raee*	€
-	F300	0,50 €	91,23 €



Mod.	Ref.	Raee*	€
2 X 15 W	F311	0,50 €	124,48 €
2 X 18 W	F312	0,50 €	124,48 €
2 X 30 W	F314	0,50 €	124,48 €
2 X 36 W	F315	0,50 €	124,48 €
2 X 58 W	F316	0,50 €	136,81 €



Mod.	Ref.	Raee*	€
2 X 15 W	F321	0,50 €	124,48 €
2 X 18 W	F322	0,50 €	124,48 €
2 X 30 W	F324	0,50 €	124,48 €
2 X 36 W	F325	0,50 €	124,48 €
2 X 58 W	F326	0,50 €	136,81 €



Mod.	Ref.	Raee*	€
2 X 15 W	F331	0,50 €	124,48 €
2 X 18 W	F332	0,50 €	124,48 €
2 X 30 W	F334	0,50 €	124,48 €
2 X 36 W	F335	0,50 €	124,48 €
2 X 58 W	F336	0,50 €	136,81 €



Mod.	Ref.	Raee*	€
4 X 15 W	F341	0,50 €	151,88 €
4 X 18 W	F342	0,50 €	151,88 €
4 X 30 W	F344	0,50 €	151,88 €
4 X 36 W	F345	0,50 €	151,88 €
4 X 58 W	F346	0,50 €	175,21 €



Mod.	Ref.	Raee*	€
4 X 15 W	F351	0,50 €	151,88 €
4 X 18 W	F352	0,50 €	151,88 €
4 X 30 W	F354	0,50 €	151,88 €
4 X 36 W	F355	0,50 €	151,88 €
4 X 58 W	F356	0,50 €	175,21 €



Mod.	Ref.	Raee*	€
4 X 15 W	F361	0,50 €	151,88 €
4 X 18 W	F362	0,50 €	151,88 €
4 X 30 W	F364	0,50 €	151,88 €
4 X 36 W	F365	0,50 €	151,88 €
4 X 58 W	F366	0,50 €	175,21 €

MÓDULO ANGULAR
ANGULAR MODULE
MODULE ANGULAIRE



Mod.	Ref.	Raee*	€
-	F200	0,50 €	79,14 €



Mod.	Ref.	Raee*	€
2 X 15 W	F211	0,50 €	111,75 €
2 X 18 W	F212	0,50 €	112,10 €
2 X 30 W	F214	0,50 €	112,10 €
2 X 36 W	F215	0,50 €	112,45 €
2 X 58 W	F216	0,50 €	120,04 €



Mod.	Ref.	Raee*	€
2 X 15 W	F221	0,50 €	111,75 €
2 X 18 W	F222	0,50 €	112,10 €
2 X 30 W	F224	0,50 €	112,10 €
2 X 36 W	F225	0,50 €	112,45 €
2 X 58 W	F226	0,50 €	120,04 €



Mod.	Ref.	Raee*	€
2 X 15 W	F231	0,50 €	144,20 €
2 X 18 W	F232	0,50 €	145,97 €
2 X 30 W	F234	0,50 €	144,89 €
2 X 36 W	F235	0,50 €	146,89 €
2 X 58 W	F236	0,50 €	162,06 €

MÓDULO EN CRUZ
CROSS MODULE
MODULE EN CROIX

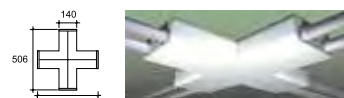

Mod.	Ref.	Raee*	€
-	F400	0,50 €	117,20 €



Mod.	Ref.	Raee*	€
2 X 15 W	F411	0,50 €	151,47 €
2 X 18 W	F412	0,50 €	151,47 €
2 X 30 W	F414	0,50 €	151,47 €
2 X 36 W	F415	0,50 €	151,47 €
2 X 58 W	F416	0,50 €	163,82 €



Mod.	Ref.	Raee*	€
2 X 15 W	F421	0,50 €	179,00 €
2 X 18 W	F422	0,50 €	179,00 €
2 X 30 W	F424	0,50 €	179,00 €
2 X 36 W	F425	0,50 €	179,00 €
2 X 58 W	F426	0,50 €	203,56 €



Mod.	Ref.	Raee*	€
4 X 15 W	F431	0,50 €	179,00 €
4 X 18 W	F432	0,50 €	179,00 €
4 X 30 W	F434	0,50 €	179,00 €
4 X 36 W	F435	0,50 €	179,00 €
4 X 58 W	F436	0,50 €	203,56 €

5.8

Iluminación residencial
Residential lighting
Éclairage résidentiel

SÓLO PARA MODELOS ESPECIALES

ONLY FOR SPECIAL MODELS

SEULEMENT POUR MODÈLES SPECIAUX

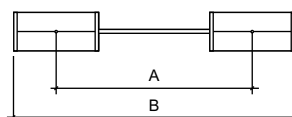
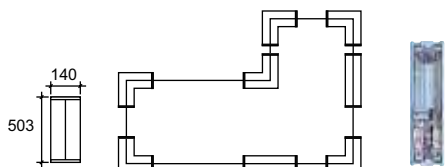

Mod.	Ref.	Raee	€
-	F500	0,50 €	61,20 €
2 X 15 W	F511	0,50 €	90,89 €
2 X 18 W	F512	0,50 €	92,39 €
2 X 30 W	F514	0,50 €	91,81 €
2 X 36 W	F515	0,50 €	92,85 €
2 X 58 W	F516	0,50 €	100,43 €

DIMENSIONES / DIMENSIONS / DIMENSIONS

W	15	18	30	36	58
A (mm)	724	876	1.178	1.486	1.786
B (mm)	1.061	1.213	1.515	1.823	2.123



Barras cableadas de aluminio
Wiring tube
 Tubes passe-fils d'aluminium

	Ref.	€
Tubo pasacable 15 W / Wiring tube 15 W / Tube passe-fils 15 W	FC15B	14,96 €
Tubo pasacable 18 W / Wiring tube 18 W / Tube passe-fils 18 W	FC18B	16,25 €
Tubo pasacable 30 W / Wiring tube 30 W / Tube passe-fils 30 W	FC30B	19,55 €
Tubo pasacable 36 W / Wiring tube 36 W / Tube passe-fils 36 W	FC36B	22,39 €
Tubo pasacable 58 W / Wiring tube 58 W / Tube passe-fils 58 W	FC58B	25,82 €



Reflector aluminio brillante (film protector)
Glossy aluminium reflector
Réflecteur aluminium brillant

	Ref.	€
Reflector 15 W / Reflector 15 W / Reflector 15 W	FR150	11,97 €
Reflector 18 W / Reflector 18 W / Reflector 18 W	FR180	17,24 €
Reflector 30 W / Reflector 30 W / Reflector 30 W	FR300	16,72 €
Reflector 36 W / Reflector 36 W / Reflector 36 W	FR360	15,23 €
Reflector 58 W / Reflector 58 W / Reflector 58 W	FR580	15,23 €



Suspensiones
Suspensions
Suspensions

	Ref.	€
Con tija de 95 mm / Stem suspension 95 mm / Avec tige de 95 mm	FS95	4,10 €
Con tija de 250 mm / Stem suspension 250 mm / Avec tige de 250 mm	FS25	7,08 €
Con tija de 500 mm / Stem suspension 500 mm / Avec tige de 500 mm	FS50	9,99 €
Con tija de 1000 mm / Stem suspension 1000 mm / Avec tige de 1000 mm	FS10	13,63 €
Con tija de 1500 mm / Stem suspension 1500 mm / Avec tige de 1500 mm	FS15	22,46 €
Con cable de acero 1900mm / Steel cable 1900mm / Avec câble en acier 1900 mm	FS99	6,04 €

Disponible en los siguientes colores:
 Ref luminaria + ref color. Ej.: F300B

Available in the different colours:
 Light fitting ref + ref colour. Ex.: F300B

Disponible dans les suivantes couleurs:
 Ref luminaire + ref couleur. Ej.: F300B

Color Colour Couleur	Ral.	Ref.
	9010	B
	9011	N

5.9

Iluminación residencial

Residential lighting

Éclairage résidentiel



CON REFLECTOR
WITH REFLECTOR
AVEC RÉFLECTEUR

ES

El modelo F-328 se caracteriza por su elegante diseño y su perfecto acabado, que lo convierte en el adecuado para la iluminación de espacios en los que prime la estética.

Por otro lado, permite una gran sencillez de montaje en la formación de líneas continuas, gracias a sus accesorios.

Características generales

- Cuerpo luminaria: Aluminio extrusionado.
- Reflector: Aluminio brillante (incluido).
- Difusor: Policarbonato (opcional).
- Rejilla: Aluminio (opcional).
- Tapas finales: A.B.S.

EN

Model F-328 is characterized by its elegant design and perfect finish, which makes it suitable for lighting areas where aesthetics are an important factor.

Furthermore it is extremely easy to assemble, forming continuous lines, thanks to its accessories.

General characteristics

- Light fitting body: Extruded aluminium.
- Reflector: Glossy aluminium (included).
- Diffuser: Polycarbonate (optional).
- Louvre: Aluminium (optional).
- End caps: A.B.S.





FR

Le modèle F-328 est caractérisé par son élégante conception et sa parfaite finition, ce qui fait que ce modèle soit idéale pour éclairer des espaces où l'esthétique soit l'aspect le plus important.

D'autre part, il permet un montage simple lorsqu'on fait des lignes continues grâce à ses accessoires.

Caractéristiques générales

- Corps du luminaire: Aluminium extrudé.
- Réflecteur: Aluminium brillant (inclus).
- Diffuseur: Polycarbonate (optionnel).
- Grille: Aluminium (optionnel).
- Embouts: A.B.S.

Color Colour Couleur	Ral.	Ref.
	6018	V
	9010	B
	1021	A
	3000	R
	9011	N

Disponible en los siguientes colores:
Ref luminaria + ref color. Ej.: G019V

Available in the different colours:
Light fitting ref + ref colour. Ex.: G019V

Disponible dans les suivantes couleurs:
Ref luminaire + ref couleur. Ej.: G019V



Ficha técnica
Technical data
Fiche technique



DISPONIBLE PARA LED
CONSULTAR PRECIO

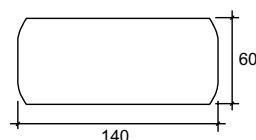

2 TUBOS FLUORESCENTES / 2 LAMPS / 2 LAMPES

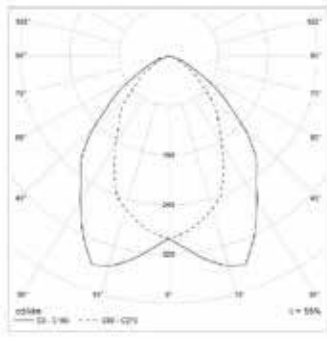

- Alto factor / High factor / Compensé
- Electrónica / Electronic / Electronique
- Regulable / Dimmable / Gradable

Ref.	Potencia Watts Puissance	Equipo Equipment Ballast	Largo Length Longueur	Raee EU Recyclable tax Ecotaxe	Precio Price Prix
G019	15 W	●	488	0,50 €	75,19 €
G022	18 W	●	640	0,50 €	97,39 €
G089	18 W	●	640	0,25 €	96,86 €
G103	18 W	●	640	0,25 €	136,86 €
G028	30 W	●	931	0,50 €	113,09 €
G031	36 W	●	1.231	0,50 €	128,70 €
G083	36 W	●	1.231	0,50 €	127,26 €
G104	36 W	●	1.231	0,50 €	167,26 €
G034	58 W	●	1.536	0,50 €	153,68 €
G086	58 W	●	1.536	0,50 €	140,18 €
G105	58 W	●	1.536	0,50 €	180,18 €

ACCESORIOS / ACCESSORIES / ACCESSOIRES



Tija de tubo
Tube stem
Tige de tube

	Ref.	€
Con tija de 95 mm / Stem suspensión 95 mm / Conn tige de 95 mm	G066	4,10 €
Con tija de 250 mm / Stem suspensión 250 mm / Conn tige de 250 mm	G067	7,08 €
Con tija de 500 mm / Stem suspensión 500 mm / Conn tige de 500 mm	G068	9,99 €
Con tija de 1000 mm / Stem suspensión 1000 mm / Conn tige de 1000 mm	G069	13,63 €
Con tija de 1500 mm / Stem suspensión 1500 mm / Conn tige de 1500 mm	G070	22,46 €

REF. G071



Soporte giratorio
Revolving support
Support tournant

6,04

REF. G072



Cable de acero 1900 mm
Steel cable 1900 mm
Câble en acier 1900 mm

9,64 €

Disponible en los siguientes colores:
Ref luminaria + ref color. Ej.: G066B

Available in the different colours:
Light fitting ref + ref colour. Ex.: G066B

Disponible dans les suivantes couleurs:
Ref luminaire + ref couleur. Ej.: G066B

Color Colour Couleur	Ral.	Ref.
	9010	B
	9011	N

ACCESORIOS / ACCESSORIES / ACCESSOIRES

REF. G0490

3,85 €



Adaptador línea continua
Continue line adapter
Adaptateur ligne continue

REF. G051

51,24 €



Adaptador "T"
"T" adapter
Adaptateur "T"



REF. GP32

0,53 €

Perfil (cm)
Profile (cm)
Profil (cm)

REF. G050

42,32 €



Adaptador ángulo
Angle adapter
Adaptateur angle

REF. G052

49,04 €



Adaptador cruz
Cross adapter
Adaptateur "X"

REF. GT32

0,16 €

Tapa (cm)
End cap (cm)
Couvercle (cm)

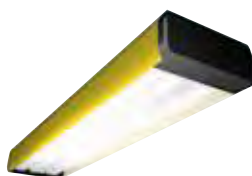

Difusor
Diffuser
Diffuseur

	Ref.	€
Difusor 15 W / Diffuser 15 W / Diffuseur 15 W	G0530	4,90 €
Difusor 18 W / Diffuser 18 W / Diffuseur 18 W	G0540	6,68 €
Difusor 30 W / Diffuser 30 W / Diffuseur 30 W	G0560	10,23 €
Difusor 36 W / Diffuser 36 W / Diffuseur 36 W	G0570	13,79 €
Difusor 58 W / Diffuser 58 W / Diffuseur 58 W	G0580	17,29 €

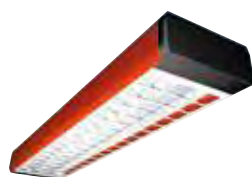

Rejilla
Louvre
Grille

	Ref.	€
Rejilla 15 W / Louvre 15 W / Grille 15 W	G0590	5,93 €
Rejilla 18 W / Louvre 18 W / Grille 18 W	G0600	9,72 €
Rejilla 30 W / Louvre 30 W / Grille 30 W	G0620	10,12 €
Rejilla 36 W / Louvre 36 W / Grille 36 W	G0630	18,07 €
Rejilla 58 W / Louvre 58 W / Grille 58 W	G0640	22,77 €

5.10

Iluminación residencial

Residential lighting

Éclairage résidentiel

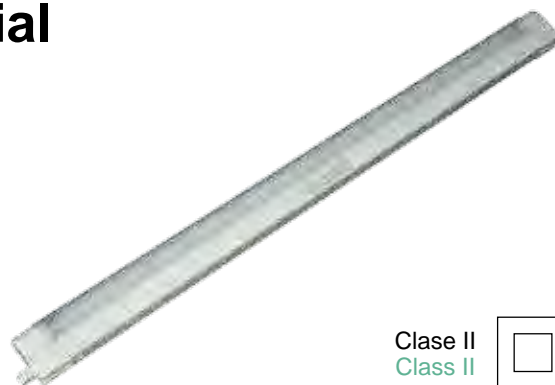

Clase II
Class II

**ES****Características generales**

- Cuerpo luminaria: Material plástico.
- Difusor: Policarbonato extruido.
- Temperatura de funcionamiento: De +5° C a +40° C.

EN**General characteristics**

- Light fitting body: Plastic material.
- Diffuser: Extruded in polycarbonate.
- Working temperature: From +5° C to +40° C.

FR**Caractéristiques générales**

- Corps du luminaire: Matériel plastique.
- Diffuseur: Polycarbonate extrudé.
- Température d'utilisation: De +5° C à +40° C.

PRODUCTO NO RECOMENDADO PARA USO COMERCIAL INTENSIVO.

PRODUCT NOT RECOMMENDED FOR HEAVY COMMERCIAL USE.

LE PRODUIT N'EST PAS RECOMMANDÉ POUR UN USAGE COMMERCIAL INTENSIF.



Ficha técnica
Technical data
Fiche technique

ACCESORIO / ACCESSORIE / ACCESSOIRE

REF. IM062

0,60 €
L = 270 mm



Cable conexión

(accesorio para montaje en línea)

Cable connection

(continuous line assembly accesorie)

Fil de connexion

(accessoire pour le montage en ligne continue)



TODAS LAS LUMINARIAS INCLUYEN ENCHUFE CON TUBO FLUORESCENTE DE MUESTRA
THIS LIGHT FITTINGS INCLUDED PLUG AND GRATUITE LAMP
TOUS LES LUMINAIRES INCLUENT UNE PRISE DE COURANT AVEC UNE LAMPE ÉCHANTILLON
POUR VÉRIFIER SON FONCTIONNEMENT



Ref.	Potencia Watts Puissance	Equipo Equipment Ballast	Largo Length Longueur	Raee EU Recyclable tax Ecotaxe	Precio Price Prix
IM045	8 W	●	343	0,25 €	7,53 €
IM044	13 W	●	571	0,25 €	7,08 €
IM046	14 W	●	601	0,25 €	9,42 €
IM047	21 W	●	901	0,25 €	12,09 €
IM048	28 W	●	1.201	0,25 €	15,51 €
IM049	35 W	●	1.501	0,25 €	18,21 €

● Electrónica / Electronic / Électronique

MONTAJE EN LÍNEA / CONTINUOUS LINE ASSEMBLY / MONTAGE EN LIGNE



W	8	13/14	21	28	35
Conexión máxima en línea Maximum connection on line Connexion en ligne maximum	10 UDS.	8 UDS.	6 UDS.	4 UDS.	2 UDS.

5.11

Iluminación residencial Residential lighting Éclairage résidentiel



CON DIFUSOR OPAL
WITH MATTE DIFFUSER
AVEC DIFFUSEUR OPAL



CON DIFUSOR TRANSPARENTE
WITH TRANSPARENT DIFFUSER
AVEC DIFFUSEUR TRANSPARENT

ES

Lineas redondeadas y limpias para una luminaria utilizada para incorporar a muebles, cocinas, etc.

Características generales

- Cuerpo luminaria: Aluminio extrusionado.
- Reflector: Metálico lacado en blanco.
- Difusor: Policarbonato.
- Sujeciones: Policarbonato.
- Tapas finales: A.B.S.

EN

Rounded and clean lines on a light fitting that can be incorporated into furnishings, kitchens, etc.

General characteristics

- Light fitting body: Extruded aluminium.
- Reflector: Lacquered steel.
- Diffuser: Polycarbonate.
- Sujections: Polycarbonate.
- End caps: A.B.S.

FR

Rounded and clean lines on a light fitting that can be incorporated into furnishings, kitchens, etc.

Caractéristiques générales

- Light fitting body: Extruded aluminium.
- Reflector: Lacquered steel.
- Diffuser: Polycarbonate.
- Sujections: Polycarbonate.
- End caps: A.B.S.



Ficha técnica
Technical data
Fiche technique



DISPONIBLE PARA LED
CONSULTAR PRECIO

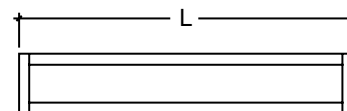
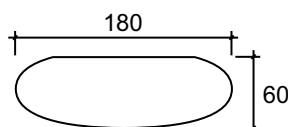

2 TUBOS FLUORESCENTES / 2 LAMPS / 2 LAMPES DIFUSOR OPAL / OPAL DIFFUSER / DIFFUSEUR OPAL

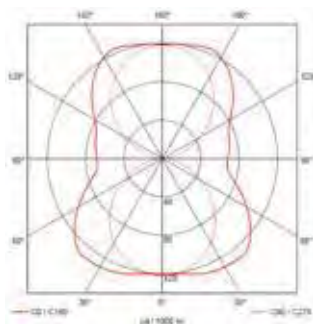

- Bajo factor / Low factor / Non-compensé
- Alto factor / High factor / Compensé
- Electrónica / Electronic / Électronique

Ref.	Potencia Watts Puissance	Equipo Equipment Ballast	Largo Length Longueur	Raee EU Recyclable tax Ecotaxe	Precio Price Prix
J0001	15 W	●	475	0,50 €	41,72 €
J0007	15 W	●	475	0,50 €	43,83 €
J0002	18 W	●	634	0,50 €	48,61 €
J0008	18 W	●	634	0,50 €	51,45 €
J0013	18 W	●	634	0,50 €	64,50 €
J0004	30 W	●	931	0,50 €	71,24 €
J0010	30 W	●	931	0,50 €	74,02 €
J0005	36 W	●	1.242	0,50 €	87,09 €
J0011	36 W	●	1.242	0,50 €	89,79 €
J0014	36 W	●	1.242	0,50 €	94,75 €
J0006	58 W	●	1.542	0,50 €	107,22 €
J0012	58 W	●	1.542	0,50 €	111,11 €
J0015	58 W	●	1.542	0,50 €	109,33 €

2 TUBOS FLUORESCENTES / 2 LAMPS / 2 LAMPES DIFUSOR TRANSPARENTE / TRANSPARENT DIFFUSER / DIFFUSEUR TRANSPARENT

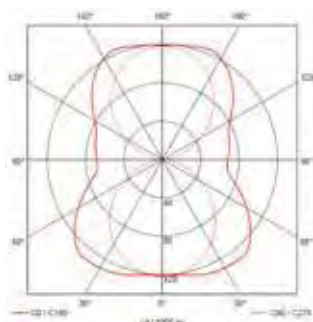

- Bajo factor / Low factor / Non-compensé
- Alto factor / High factor / Compensé
- Electrónica / Electronic / Électronique

Ref.	Potencia Watts Puissance	Equipo Equipment Ballast	Largo Length Longueur	Raee EU Recyclable tax Ecotaxe	Precio Price Prix
J0016	15 W	●	475	0,50 €	41,72 €
J0022	15 W	●	475	0,50 €	43,83 €
J0017	18 W	●	634	0,50 €	48,61 €
J0023	18 W	●	634	0,50 €	51,45 €
J0028	18 W	●	634	0,50 €	64,50 €
J0019	30 W	●	931	0,50 €	71,24 €
J0025	30 W	●	931	0,50 €	74,02 €
J0020	36 W	●	1.242	0,50 €	87,09 €
J0026	36 W	●	1.242	0,50 €	89,79 €
J0029	36 W	●	1.242	0,50 €	94,75 €
J0021	58 W	●	1.542	0,50 €	107,22 €
J0027	58 W	●	1.542	0,50 €	111,11 €
J0030	58 W	●	1.542	0,50 €	109,33 €

ACCESORIOS / ACCESSORIES / ACCESSOIRES

Suspensiones / Suspensions / Suspensions	Ref.	€
Con tija de 95 mm / Stem suspensión 95 mm / Conn tige de 95 mm	J0037	6,36 €
Con tija de 250 mm / Stem suspensión 250 mm / Conn tige de 250 mm	J0038	9,34 €
Con tija de 500 mm / Stem suspensión 500 mm / Conn tige de 500 mm	J0039	12,25 €
Con tija de 1000 mm / Stem suspensión 1000 mm / Conn tige de 1000 mm	J0040	15,89 €
Con tija de 1500 mm / Stem suspensión 1500 mm / Conn tige de 1500 mm	J0041	24,72 €
Con cable de acero 1900 mm / With steel cable 1900 mm / Avec câble en acier 1900 mm	J0042	9,60 €

5.12

Iluminación residencial Residential lighting Éclairage résidentiel



ES

Características generales

- Luminaria: Empotrable para lámpara fluorescente compacta no integrada tipo TC-D, TC-DEL.
- Reflector: Aluminio brillante.
- Aro: A.B.S. El standard incluye aro blanco en A.B.S. Disponible en varios colores y materiales.

Nuestros downlights siempre incluyen:

Muelles de sujeción de imposible pérdida según patente nº U200D01754 más caja portareactancias.

EN

General characteristics

- Light fitting body: Embedded for fluorescent lamp TC-D, TC-DEL.
- Reflector: Glossy aluminium.
- Ring: The standard model includes white A.B.S. ring. Available in different colours and materials.

Our downlights always include:

Our downlights always come with: unbreakable supports according to patent nº U200301754 and ballast holder box.

FR

Caractéristiques générales

- Luminaire: Encastrable pour lampe fluorescente compacte non intégrée du type TC-D, TC-DEL.
- Réflecteur: Aluminium brillant.
- Colerette: A.B.S. Le modèle standard inclue un colerette blanc. Disponible en plusieurs couleurs et matériels.

Nos downlights toujours incluent:

Ressorts de fixation de perte impossible d'après le brevet d'invention nº U200301754 en plus d'une boîte porte-équipe.

DOWNLIGHT 206 ø

1 LÁMPARA / 1 LAMP / 1 LAMPE

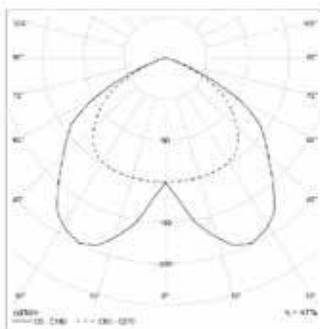

- Bajo factor
Low factor
Non-compensé
- Alto factor
High factor
Compensé
- Electrónica
Electronic
Électronique

Ref.	Potencia Watts Puissance	Equipo Equipment Ballast	Raee EU Recyclable tax Ecotaxe	Precio Price Prix
K076	10 W	●	0,50 €	32,48 €
K088	13 W	●	0,50 €	35,48 €
K092	13 W	●	0,50 €	37,59 €
K096	13 W	●	0,50 €	64,27 €
K100	18 W	●	0,50 €	35,68 €
K104	18 W	●	0,50 €	37,91 €
K108	18 W	●	0,50 €	49,49 €



Ficha técnica
Technical data
Fiche technique

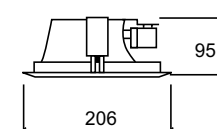

DOWNLIGHT 230 ø

1 LÁMPARA / 1 LAMP / 1 LAMPE

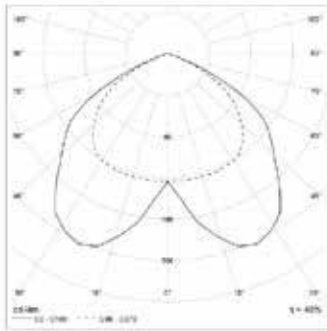

- Bajo factor
Low factor
Non-compensé
- Alto factor
High factor
Compensé
- Electrónica
Electronic
Électronique

Ref.	Potencia Watts Puissance	Equipo Equipment Ballast	Raee EU Recyclable tax Ecotaxe	Precio Price Prix
K304	18 W	●	0,50 €	35,40 €
K336	18 W	●	0,50 €	37,84 €
K320	18 W	●	0,50 €	49,89 €
K308	26 W	●	0,50 €	35,97 €
K340	26 W	●	0,50 €	38,02 €
K324	26 W	●	0,50 €	50,00 €

2 LÁMPARAS / 2 LAMPS / 2 LAMPES

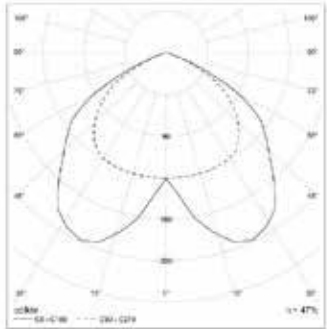

- Bajo factor
Low factor
Non-compensé
- Alto factor
High factor
Compensé
- Electrónica
Electronic
Électronique
- Regulable
Dimmable
Gradable

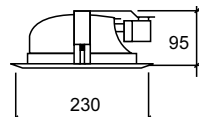

Ref.	Potencia Watts Puissance	Equipo Equipment Ballast	Raee EU Recyclable tax Ecotaxe	Precio Price Prix
K352	13 W	●	0,50 €	50,32 €
K356	13 W	●	0,50 €	52,41 €
K360	13 W	●	0,50 €	70,24 €
K312	18 W	●	0,50 €	50,73 €
K344	18 W	●	0,50 €	53,04 €
K328	18 W	●	0,50 €	60,70 €
K003	18 W	●	0,50 €	100,70 €
K316	26 W	●	0,50 €	51,62 €
K348	26 W	●	0,50 €	52,36 €
K332	26 W	●	0,50 €	59,79 €
K005	26 W	●	0,50 €	99,79 €

DOWNLIGHT 245 ø

1 LÁMPARA / 1 LAMP / 1 LAMPE

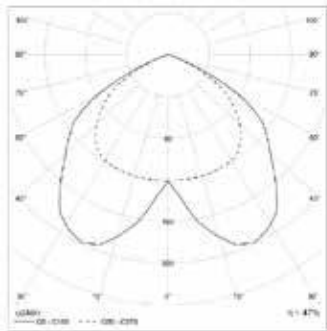

- Bajo factor
Low factor
Non-compensé
- Alto factor
High factor
Compensé
- Electrónica
Electronic
Électronique

Ref.	Potencia Watts Puissance	Equipo Equipment Ballast	Raee EU Recyclable tax Ecotaxe	Precio Price Prix
K004	18 W	●	0,50 €	38,05 €
K036	18 W	●	0,50 €	40,27 €
K020	18 W	●	0,50 €	52,57 €
K008	26 W	●	0,50 €	38,53 €
K040	26 W	●	0,50 €	40,58 €
K024	26 W	●	0,50 €	52,30 €

2 LÁMPARAS / 2 LAMPS / 2 LAMPES

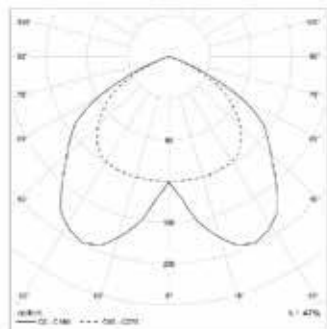

- Bajo factor
Low factor
Non-compensé
- Alto factor
High factor
Compensé
- Electrónica
Electronic
Électronique
- Regulable
Dimmable
Gradable

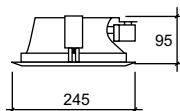

Ref.	Potencia Watts Puissance	Equipo Equipment Ballast	Raee EU Recyclable tax Ecotaxe	Precio Price Prix
K052	13 W	●	0,50 €	52,97 €
K056	13 W	●	0,50 €	55,06 €
K060	13 W	●	0,50 €	72,71 €
K012	18 W	●	0,50 €	53,37 €
K044	18 W	●	0,50 €	55,69 €
K028	18 W	●	0,50 €	63,05 €
K001	18 W	●	0,50 €	103,05 €
K016	26 W	●	0,50 €	54,58 €
K048	26 W	●	0,50 €	56,90 €
K032	26 W	●	0,50 €	62,14 €
K002	26 W	●	0,50 €	102,14 €

5.12

Iluminación residencial Residential lighting Éclairage résidentiel



LAMPARAS NO INCLUIDAS
LAMPS NOT INCLUDED
LAMPES NON INCLUS

ES

El futuro en downlights. Electrónico y sin equipo externo, lo que permite menor consumo y menos ruido, por falta de vibración de la caja.

EN

The future in downlights. Electronic and without external equipment, which means lower consumption and less noise, due to the lack of vibrations in the casting.

FR

Sans équipe externe et électronique, ce qui permet une moindre consommation et moins de bruit, grâce au manque de vibration de la boîte porte-équipe.

DOWNLIGHT 206 ø

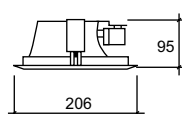

175 mm.

Ref.	Portalámparas Lampholder Douille	Raee EU Recyclable tax Ecotaxe	Precio Price Prix
K509	1 x E-27	0,50 €	16,83 €

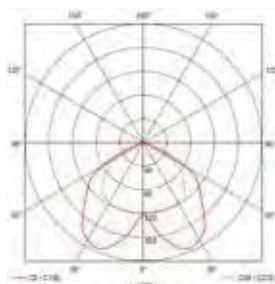

DOWNLIGHT 230 ø

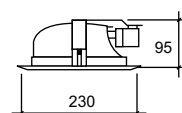

189 mm.

Ref.	Portalámparas Lampholder Douille	Raee EU Recyclable tax Ecotaxe	Precio Price Prix
K508	1 x E-27	0,50 €	17,20 €
K511	2 x E-27	0,50 €	18,03 €

DOWNLIGHT 245 ø

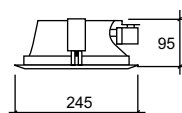

210 mm.

Ref.	Portalámparas Lampholder Douille	Raee EU Recyclable tax Ecotaxe	Precio Price Prix
K502	1 x E-27	0,50 €	19,39 €
K504	2 x E-27	0,50 €	20,38 €



Ficha técnica
Technical data
Fiche technique



DISPONIBLE PARA LED
CONSULTAR PRECIO

ACCESORIOS / ACCESSORIES / ACCESSOIRES

MOD.	Ø 245		Ø 230		Ø 206	
	Ref.	€	Ref.	€	Ref.	€
Cristal transparente / <i>Transparent glass / Verre transparent</i>	K000T	1,18 €	KM00T	0,91 €	KP00T	0,68 €
Cristal serigrafiado / <i>Draw glass / Verre sérigraphié</i>	K000S	1,23 €	KM00S	1,23 €	KP00S	0,68 €
Cristal opal / <i>Matte glass / Verre opal</i>	K000O	1,23 €	KM00O	1,23 €	KP00O	0,63 €
Aro plástico negro / <i>Black plastic ring / Colerette plastique noir</i>	K000N	1,00 €	KM00N	1,00 €	KP00N	1,00 €
Aro plástico cromo mate / <i>Matte chrome plastic ring / Colerette plastique chrome mate</i>	K000P	1,16 €	KM00P	1,33 €	KP00P	0,88 €
Aro plástico oro brillo / <i>Glossy gold plastic ring / Colerette plastique or brillant</i>	K000G	2,50 €	KM00G	2,50 €	KP00G	2,12 €
Aro metálico blanco / <i>White metallic ring / Colerette métallique blanc</i>			KM0MB	2,41 €		
Aro metálico cromo mate / <i>Matte chrome metallic ring / Colerette métallique chrome mate</i>			KM0MP	2,50 €		
Aro metálico negro / <i>Black metallic ring / Colerette métallique noir</i>			KM0MN	2,41 €		
Caja portareactancias clase II / <i>Ballast box class II / Boîte porte-équipe classe II</i>	KCLA2	4,57 €	KCLA2	4,57 €	KCLA2	4,57 €



DOWNLIGHT

Showroom, Zaragoza, España

Showroom, Zaragoza, Spain

Showroom, Saragosse, Espagne



DOWNLIGHT

Showroom, Zaragoza, España
Showroom, Zaragoza, Spain
Showroom, Saragosse, Espagne

5.13

Iluminación residencial
Residential lighting
Éclairage résidentiel

	Técnica Technical Technique
Accesos de pública concurrencia <i>Crowded public access</i> <i>Accès publics à forte densité</i>	CYLINDRIC +
Aeropuertos / estaciones de tren, metro <i>Airport / Railway station</i> <i>Aéroports / stations de train, métro</i>	DOWNLIGHTS
Escaparates <i>Shop windows</i> <i>Vitrines</i>	DOWNLIGHTS, NEVADA MODELO 1, F328, COBRA NEVADA
Aulas de enseñanza <i>Classrooms</i> <i>Salles de classe</i>	DOWNLIGHTS
Comercios y escaparates <i>Shops and shop windows</i> <i>Commerces et vitrines</i>	DOWNLIGHTS, MODELO 1 COBRA, NEVADA
Iluminación portátil <i>Portable lighting</i> <i>Éclairage portatif</i>	CYLINDRIC
Hospitales <i>Hospitals</i> <i>Hôpital</i>	DOWNLIGHTS
Oficinas <i>Offices</i> <i>Bureaux</i>	DOWNLIGHTS NEVADA
Supermercados <i>Supermarkets</i> <i>Supermarchés</i>	DOWNLIGHTS NEVADA
Mobiliario residencial <i>Residential furniture</i> <i>Meubles résidentiels</i>	SLIM, ESFERAS, JOTA MODELO X, MODELO 1 CYLINDRIC



TR3

Feria de Zaragoza
Funfaire, Zaragoza
Fête foraine, Saragosse





TR3 OPAL / MATTE / OPALE

Parking Serrano Park, Madrid, España

[Serrano Park parking, Madrid, Spain](#)

Parking Serrano Park, Madrid, Espagne



TR3 OPAL / MATTE / OPALE

Parking Serrano Park, Madrid, España

[Serrano Park parking, Madrid, Spain](#)

Parking Serrano Park, Madrid, Espagne



KITS DE EMERGENCIA Y DATOS TÉCNICOS EMERGENCY KIT AND TECHNICAL DATA ÉCLAIRAGE DE SECOURS ET DONNÉES TECHNIQUES

6.1	KITS DE EMERGENCIA EMERGENCY KIT ÉCLAIRAGE DE SECOURS	264
6.2	DATOS TÉCNICOS TECHNICAL DATA DONNÉES TECHNIQUES	266

6.1

Kits de emergencia y datos técnicos

Emergency kit and technical data

Éclairage de secours et données techniques

ES

El kit de conversión tiene como finalidad la transformación de una luminaria fluorescente en una luminaria de emergencia.

Está compuesto por un módulo cargador-convertidor y una batería estanca de Ni-Cd de alta temperatura.

Cuando hay presencia de red mediante el módulo cargador-convertidor, la batería recibe carga y el led se ilumina indicando tal circunstancia. En ausencia de red el módulo pone en funcionamiento el convertidor que se queda alimentado por la batería y la lámpara fluorescente continúa encendida a un nivel inferior que en presencia de red.

- Tensión de alimentación: 220 +6% - 10% a 50-60 Hz.
- Temperatura de funcionamiento: 0 a 40 grados C.
- Protecciones: Contra sobre intensidades. Transformador cortocircuitable. Limitador de descarga de batería.

El Kit lleva un Puente, que dejándolo puesto o quitándolo se pueden obtener diversas autonomías y rendimientos.

EN

The Conversion kit's purpose is to transform a fluorescent light fixture into an emergency one.

It is made of a converting-charging module and a Ni-Cd high temperature waterproof battery.

In the presence of power, through the converting-charging module, the battery receives a charge and the led lights up, indicating such circumstance. In the absence of power, the module turns on the converter, which is then fed from the battery and the fluorescent lamp continues lighting up at a lower level than when power is on.

- Power intensity: 220 + 6% +10% to 50-60 Hz.
- Working temperature: 0 to 40 degrees C.
- Protections: Against intensity changes. Shortcircuitable transformer. Battery loss limiter.

The kit has a connection that, leaving it on or off, can obtain different autonomies and efficiencies.

FR

Le kit de conversion a comme objectif la transformation d'un luminaire fluorescent en un luminaire d'urgence.

Il composé par un module chargeur-convertisseur et une batterie étanche de Ni-Cd de haute température.

Quand il y a présence de réseau, grâce au module chargeur-convertisseur, la batterie est en charge, et le LED s'éclaire indiquant cette circonstance. En absence de réseau, le module met en marche le convertisseur, qui est alimenté par la batterie et la lampe fluorescente continue allumée à un niveau inférieur que lorsqu'il y a réseau.

- Tension d'alimentation: 220 +6% - 10% à 50-60 Hz.
- Température d'utilisation: 0 à 40°C.
- Protections: Contre des surintensités. Transformateurs court-circuitable. Limiteur de décharge de la batterie.

Le kit possède un jumper électrique, qui peut être mis ou enlever pour obtenir divers rendements et autonomies.

COMPATIBILIDAD / COMPATIBILITY / COMPATIBILITÉ

Modelo Model Modèle	Portalámparas Lampholder Douille	Portalámparas Lampholder Douille
Delta, Superdelta, Modelo M, Jota, Deco, Metallic, TR2, TR3, Secure, Resist, Cobra, Nevada, Modelo X y F-328	T8: Desde / From / À partir de 18 W T5: Desde / From / À partir de 14 W	T8: Desde / From / À partir de 30 W T5: Desde / From / À partir de 21 W
Luxstar T8 y Luxstar T5	T8: Desde / From / À partir de 18 W T5: Desde / From / À partir de 14 W	T8: Desde / From / À partir de 36 W T5: Desde/From/À partir 28 W
Minidelta y Modelo 1	T8: Desde / From / À partir de 30 W T5: Desde / From / À partir de 21 W	T8: Desde / From / À partir de 30 W T5: Desde / From / À partir de 21 W
Downlight, TR4, Compact, TR1, Tunnel, Pyros, Vitra y Chemical	Todas / All / Tous	Todas / All / Tous

6.1

Kits de emergencia y datos técnicos
Emergency kit and technical data
Éclairage de secours et données techniques

Modelo Model Modèle	Wattios Watts Puissance	Rendimiento Efficiency Rendement	Autonomía Autonomy Autonomie	Precio Price Prix
OEM02	T8 - 18 W T8 - 36 W T8 - 58 W	27 % 22 % 20 %	1 h. 1 h. 1 h.	146,84 €
OEM04	T8 - 18 W T8 - 30 W T8 - 36 W T8 - 58 W T5 - 14 W T5 - 21 W T5 - 24 W T5 - 28 W T5 - 35 W T5 - 39 W T5 - 49 W T5 - 54 W T5 - 49 W	18 % 16 % 9 % 6 % 20 % 18 % 18 % 12 % 9 % 9 % 7 % 6 % 4 %	1 h. 1 h. 1 h. 1 h. 1 h. 1 h. 1 h. 1 h. 1 h. 1 h. 1 h. 1 h. 1 h.	172,52 €
OEM05	T8 - 18 W T8 - 36 W T8 - 58 W	22 % 13 % 9 %	3 h. 3 h. 3 h.	150,45 €
OEM06	MODULOS LED	CONSULTAR	1 h.	179,88 €

COMPATIBILIDAD / COMPATIBILITY / COMPATIBILITÉ

ES

Modo No Permanente

En este modo la luminaria no lleva reactancia, siendo el Kit de emergencia el que hace la función de reactancia. La luminaria solamente entra en funcionamiento cuando la tensión de red cae por debajo del 70% del valor nominal, entrando en funcionamiento el Kit de emergencia y encendiendo la lámpara a la que está conectado. En este modo se pueden montar todas las potencias para un tubo, tanto en T8, T5 como lámparas compactas de 4 pines.

Para 2 tubos se deberá consultar con fábrica para cada caso.

Modo Permanente

En este modo la luminaria lleva reactancia y Kit de emergencia. Las lámparas para alumbrado de emergencia están alimentadas permanentemente; cuando hay tensión de red están alimentadas por la reactancia y cuando un fallo de red están alimentadas por el Kit de emergencia.

Modo Combinado

En este modo la luminaria lleva reactancia y Kit de emergencia. La luminaria lleva 2 o más lámparas, de las que al menos una está alimentada por el Kit de emergencia y el resto están alimentadas por la reactancia.

EN

Non permanent mode

On this mode, the light fixture doesn't have any ballast, being the emergency kit the one that starts working, when the tension falls under 70% of their nominal value, in which case the kit works and lights up the lamp to which is connected. This mode can be used to assemble all tube power varieties, T8, T5 as well as 4 pins compact lamps.

For 2 tubes, please consult.

Permanent mode

On this mode, the light fixture has a ballast and emergency kit. The emergency lighting lamps are fed permanently. In presence of power they are fed by the ballast and in absence of power, they are fed by the kit.

Combined mode

On this mode, the light fixture has both ballast and kit. It has 2 or more lamps, of which at least one is fed by the emergency kit and the rest are fed by the ballast.

FR

Mode Non Permanent

Dans ce mode, le luminaire ne comporte pas de ballast, le Kit d'urgence remplissant cette fonction.

Le luminaire entre seulement en fonctionnement lorsque la tension du réseau chute en dessous de 70% de la valeur nominale, le Kit d'urgence s'activant alors et allumant la lampe à laquelle il est connecté.

Dans ce mode, on peut monter toutes les puissances pour un tube, tant pour T8, T5 que pour les lampes compactes à 4 broches. Pour 2 tubes, on devra consulter l'usine dans chaque cas.

Mode Permanent

Dans ce mode, le luminaire comporte un ballast et un Kit d'urgence. Les lampes de l'éclairage d'urgence sont alimentées en permanence; en cas de tension de réseau, elles sont alimentées par le ballast et en cas de chute de tension sur le réseau, elles sont alimentées par le Kit d'urgence.

Mode Combiné

Dans ce mode, le luminaire comporte un ballast et un Kit d'urgence. Le luminaire comporte 2 ou plusieurs lampes dont une au moins est alimentée par le Kit d'urgence, les autres étant alimentées par le ballast.

6.2

Kits de emergencia y datos técnicos**Emergency kit and technical data****Éclairage de secours et données techniques****CLASIFICACIÓN DE LAS LUMINARIAS****CLASSIFICATION OF LIGHT FITTINGS****CLASSIFICATION DES LUMINAIRES**

ES

Existen cuatro modos de clasificación de las luminarias según el tipo de protección contra los choques eléctricos, grado de protección contra el polvo y la humedad, grado de protección contra impactos y del material de la superficie sobre la que se coloque la luminaria.

EN

There are four ways of classifying light fittings: according to the type of protection offered against electric shocks, according to the level of protection against dust and humidity, according to the level of protection against impacts and finally, according to the material used for the surface in which the light fitting is inserted.

FR

Ils existent quatre modes de classification des luminaires selon le type de protection contre les chocs électriques, degré de protection contre la pénétration de poussières et d'humidité, degré de protection contre les chocs et la matière de la surface d'appui.

6.2

Kits de emergencia y datos tecnicos

Emergency kit and technical data

Éclairage de secours et données techniques

1.- Clasificación en función del tipo de protección contra los choques eléctricos

Classification according to the type of protection offered against electric shocks
 Classification en fonction du type de protection contre les chocs électriques

ES

Las luminarias se clasifican en función de su tipo de protección contra los choques eléctricos, en Clase I, Clase II y Clase III.

EN

According to the type of protection they offer against electric shocks, light fittings are classified as Class I, Class II and Class III.

FR

Les luminaires sont classifiés en fonction de son type de protection contre les chocs électriques, en Classe I, Classe II et Classe III.

CLASE I	<p>Luminaria de Clase I: Luminaria en la que la protección contra los choques eléctricos no recae exclusivamente sobre el aislamiento principal, sino que comprende una medida de seguridad suplementaria bajo la forma de medios de conexión de las partes conductoras accesibles con un conductor de protección puesto a tierra, formando parte del cableado fijo de la instalación, de tal manera que las partes conductoras accesibles no puedan llegar a ser peligrosas, en caso de defecto del aislamiento principal.</p> <p>Class I light fittings: Light fittings in which protection against electric shocks does not depend solely on the mains insulation, but instead contain an extra safety measure in the form of a circuit from the accessible conductive parts with an grounded protective conductor forming part of the installation's fixed wiring, so that the accessible conductive parts do not become dangerous should there be a defect in the mains insulation.</p> <p>Luminaire de Classe I: Luminaire dans lequel la protection contre les chocs électriques ne repose pas uniquement sur l'isolation principale mais dans lequel une mesure de sécurité supplémentaire a été prise sous la forme de moyens de raccordement des parties conductrices accessibles à un conducteur de protection faisant partie des canalisations fixes de l'installation de sorte que les parties conductrices accessibles ne puissent devenir dangereuses en cas de défaut de l'isolation principale</p>
CLASE II	<p>Luminaria de Clase II: Luminaria en la que la protección contra los choques eléctricos no recae únicamente sobre el aislamiento principal, sino que comprende medias de seguridad suplementarias, tales como el doble aislamiento o el aislamiento reforzado. Estas medidas no comprenden medios de puesta a tierra como protección y no dependen de las condiciones de instalación.</p> <p>Class II light fittings: Light fittings in which protection against electric shocks does not depend solely on the mains insulation, but instead contains extra safety measures, such as double or reinforced insulation. These measures do not include grounding protective devices, nor are they dependent on installation conditions.</p> <p>Luminaire de Classe II: Luminaire dans lequel la protection contre les chocs électriques ne repose pas uniquement sur l'isolation principale mais dans lequel ont été prises des mesures supplémentaires de sécurité, telles que la double isolation ou l'isolation renforcée, ces mesures ne comportant pas de moyen de mise à la terre de protection et ne dépendant pas des conditions d'installation</p> <p>Símbolo para la luminaria</p> <div style="display: flex; align-items: center;">  <p>Light fitting symbol</p> </div> <p><i>Symbole pour le luminaire</i></p>
CLASE III	<p>Luminaria de Clase III: Luminaria en la que la protección contra los choques eléctricos recae en la alimentación con pequeña tensión de seguridad (PTS) y en la que no se generan tensiones superiores a la PTS.</p> <p>Class III light fittings: Light fittings in which protection against electric shocks depends on a power supply with a low safety voltage (LSV) and which does not generate voltages higher than the LSV.</p> <p>Luminaire de Classe III: Luminaire dans lequel la protection contre les chocs électriques repose sur l'alimentation sous très basse tension de sécurité (PTS) et dans lequel ne sont pas engendrées de tensions supérieures à la PTS.</p> <p>Símbolo para la luminaria</p> <div style="display: flex; align-items: center;">  <p>Light fitting symbol</p> </div> <p><i>Symbole pour le luminaire</i></p>

6.2

Kits de emergencia y datos técnicos

Emergency kit and technical data

Éclairage de secours et données techniques

2.- Clasificación en función del grado de protección contra el polvo y la humedad

Classification according to this classification system is as follows

Classification en fonction du degré de protection contre le pénétration de poussière et d'humidité

ES

El tipo de protección contemplado por este sistema de clasificación es el siguiente:

- a) Protección de las personas contra los contactos o la proximidad de las partes en tensión y contra los contactos con piezas en movimiento interiores a la envolvente y protección de los aparatos o equipos contra la penetración de cuerpos sólidos extraños.
- b) Protección de los aparatos o equipo bajo envolvente contra los efectos perjudiciales debidos a la penetración de agua.

La designación para indicar los grados de protección esta constituida por las letras características IP seguidas de dos cifras (las cifras características) que significan que los aparatos o equipos están conformes con las condiciones descritas en las tablas expuestas a continuación. La primera cifra indica el grado de protección descrito en el punto a) y la segunda cifra el grado de protección descrito en el punto b).

EN

- a) Protection of persons from contact with or proximity to live and moving parts inside the enclosure, and protection of the equipment or apparatus against the ingress of foreign solid objects.
- b) Protection of the apparatus or enclosed equipment from the damaging effects of water penetration.

The designation used to indicate the levels of protection consists of the characteristic IP letters followed by two numerals (the characteristic numerals). These mean that the apparatus or equipment is consistent with the conditions described in the following tables.

The first numeral indicates the degree of protection described in point a) while the second numeral indicates the degree of protection described in point b).

FR

Le type de protection contemplé pour ce système de classification est le suivant :



- a) La protection des personnes contre l'accès aux parties dangereuses à l'intérieur de l'enveloppe et la protection des matériels à l'intérieur de l'enveloppe contre la pénétration de corps solides étrangers;
- b) La protection des matériels à l'intérieur de l'enveloppe contre les effets nuisibles dus à la pénétration de l'eau.

La désignation pour indiquer le degré de protection est composé par les caractéristiques lettres IP suivies par deux chiffres (les chiffres caractéristiques) qui signifient que les appareils ou les équipes sont conformes avec les conditions décrites dans le tableau ci-dessous. Le premier chiffre indique le degré de protection décrits dans le point a) et le deuxième chiffre le degré de protection décrits dans le point b).

6.2







Kits de emergencia y datos tecnicos
Emergency kit and technical data
Éclairage de secours et données techniques

- a) Grados de protección indicados por la 1ª cifra característica
 a) Degree of protection indicated by the 1st characteristic numeral
 a) Degrés de protection indiqués par le 1er chiffre caractéristique

1ª cifra característica y símbolo 1st characteristic numeral and symbol 1er chiffre caractéristique et symbole	Grados de protección / Degree of protection / Degrés de protection	
	Descripción abreviada Abbreviated description Description abrégée	Indicaciones sobre el tipo de protección proporcionado por la envolvente Indications on the type of protection provided by the enclosure Indications sur le type de protection fournies par l'enveloppe
	0	No protegido No protection Pas de protection
1	Protegidos contra los cuerpos sólidos cuya dimensión mayor sea superior a 50 mm. Protection from solid objects with a diameter greater than 50 mm. Protection d'une grande surface du corps humain, de diamètre supérieur ou égal à 50 mm.	Una gran superficie del cuerpo humano, por ejemplo la mano (pero sin protección contra una penetración deliberada). Cuerpos sólidos de más de 50 mm de diámetro. Protection from a large part of the human body such as a hand (but no protection against deliberate access). Protection from solid objects with a diameter greater than 50 mm. Protection d'une grande surface du corps humain, par exemple la main. Corps solides de plus de 50mm de diamètre.
2	Protegido contra los cuerpos sólidos cuya dimensión mayor sea superior a 12 mm. Protection from solid objects with a diameter greater than 12 mm. Protégé contre la pénétration de corps solides de diamètre supérieur ou égal à 12 mm.	Los dedos u objetos análogos no superiores a 80 mm de longitud. Cuerpos sólidos de más de 12 mm de diámetro. Protection from fingers and similar objects that are not greater than 80mm in length. Protection from solid objects with a diameter greater than 12 mm. Doigts ou objets similaires qui ne dépassent pas les 80 mm de longueur. Corps étrangers solides dont le diamètre dépasse 12 mm.
3	Protegido contra los cuerpos sólidos cuya dimensión mayor sea superior 2,5 mm. Protection from solid objects with a diameter greater than 2.5 mm. Protégé contre la pénétration de corps solides de diamètre supérieur ou égal à 2,5 mm.	Herramientas, alambres, etc., de diámetro o espesor superior a 2,5 mm. Cuerpos sólidos de más de 2,5 mm de diámetro. Protection from entry by tools, wires, etc., with a diameter or width greater than 2.5 mm. Protection from entry by solid objects with a diameter greater than 2.5 mm. Outils, fils, etc., dont le diamètre ou l'épaisseur soit supérieur à 2.5 mm. Corps solides de plus de 2.5 mm de diamètre.
4	Protegidos contra los cuerpos sólidos cuya dimensión mayor sea superior a 1 mm. Protection from solid objects with a diameter greater than 1 mm. Protégé contre la pénétration de corps solides de diamètre supérieur ou égal à 1 mm.	Alambres o cintas de espesor superior a 1 mm. Cuerpos sólidos de mas de 1 mm de diámetro. Protection from entry by wires or tapes with a width greater than 1 mm. Protection from solid objects with a diameter greater than 1 mm. Protection contre la pénétration de corps étrangers solides dont le diamètre est supérieur à 1 mm (fils ou objets similaires).
5 	Protegidos contra el polvo. Protection from dust. Protégé contre les poussières (pas de dépôts nuisibles).	No se evita totalmente la penetración del polvo, pero el polvo no puede entrar en cantidad suficiente para dañar el buen funcionamiento del aparato o equipo. Dust penetration is not totally prevented, but dust cannot enter in a quantity sufficient to interfere with the satisfactory operation of the apparatus or equipment. Protection contre les dépôts de poussière nuisibles. La pénétration de poussière n'est pas totalement empêchée, mais celle-ci ne doit pas pouvoir pénétrer en quantité telle que le fonctionnement du matériel puisse être entravé.
6 	Totalmente protegidos contra el polvo. Dust-tight. Totalement protégé contre les poussières (étanche).	Sin penetración alguna de polvo. No dust penetration. Protection contre la pénétration de la poussière.

6.2 Kits de emergencia y datos tecnicos Emergency kit and technical data Éclairage de secours et données techniques

- b) Grados de protección indicados por la 2ª cifra característica
b) Degree of protection indicated by the 2nd characteristic numeral
b) Degrés de protection indiqués par le 2eme chiffre caractéristique

2ª cifra característica y símbolo 2st characteristic numeral and symbol 2eme chiffre caractéristique et symbole	Grados de protección / Degree of protection / Degrés de protection	
	Descripción abreviada Abbreviated description Description abrégée	Indicaciones sobre el tipo de protección proporcionado por la envolvente Indications on the type of protection provided by the enclosure Indications sur le type de protection fournies par l'enveloppe
0	No protegido No protection Pas de protection	Sin protección particular. No special protection. Aucune protection particulière.
1 	Protegido contra las caídas verticales de gotas de agua. Protection from vertically falling drops of water. Protégé contre les égouttements.	Las gotas de agua (que caen verticalmente) no deberán causar efectos perjudiciales. Vertically falling drops of water should have no harmful effects.
2	Protegido contra las caídas de agua para una inclinación máxima de gotas de agua. Protection from falling water at a maximum inclination of dripping water. Protégé contre les égouttements pour une inclinaison maximale de 15°.	Las caídas verticales de agua no deberán causar efectos perjudiciales cuando la envolvente está inclinada hasta 15° con respecto a su posición normal. Vertically falling drops should have no harmful effects when the enclosure is tilted at an angle of up to 15° compared to its normal position. Les chutes verticales de gouttes d'eau ne doivent pas avoir d'effets nuisibles sur le matériel quand l'enveloppe est inclinée jusqu'à 15°.
3 	Protegido contra el agua en forma de lluvia. Protection from rain water. Protégé contre l'eau « en pluie ».	El agua que cae de la lluvia en una dirección que forma con la vertical un ángulo inferior o igual a 60°, no deberá causar efectos perjudiciales. Rain water falling at an angle up to 60° degrees on either side of the vertical should have no harmful effects. L'eau tombant en pluie dans une direction faisant avec la verticale un angle inférieur ou égal à 60° ne doit pas avoir d'effets nuisibles.
4 	Protegidos contra las proyecciones de agua. Protection from splashing water. Protégé contre la pénétration de corps solides de diamètre supérieur à 1 mm.	El agua proyectada en todas las direcciones sobre la envolvente no deberá causar efectos perjudiciales. Water splashed against the enclosure from any direction should have no harmful effects. L'eau projetée de toutes les directions sur l'enveloppe ne doit pas avoir d'effets nuisibles.
5 	Protegidos contra los chorros de agua. Protection from water jets. Protégé contre les jets d'eau à la lance de toutes directions.	El agua proyectada con la ayuda de una lanza o tobera en todas las direcciones sobre la envolvente no deberá causar efectos perjudiciales. Water projected in jets against the enclosure from any direction should have no harmful effects. L'eau projetée à l'aide d'une lance de toutes les directions sur l'enveloppe ne doit pas avoir d'effets nuisibles.
6	Protegidos contra el agua de mar disparada potentemente hacia la protección del equipo desde cualquier dirección. Protégé contre les projections puissantes d'eau à la lance, assimilables aux paquets de mer.	Por mar gruesa o por el efecto de potentes surtidores, no deberán penetrar agua en la envolvente en cantidad perjudicial. Rough seas or powerful jets of water – limited ingress permitted. L'eau ne doit pas pénétrer en quantité nuisible dans l'enveloppe suite à un déferlement ou sous l'effet de jets puissants.
7 	Protegido contra los efectos de la inmersión. Protection from the effects of immersion in water. Protégé contre les effets de l'immersion temporaire.	No deberá ser posible la penetración de agua en cantidad perjudicial en el interior de la envolvente sumergida en el agua, a una presión y durante un periodo determinado. Ingress of water in quantities causing harmful effects should not be possible when the enclosure is temporarily immersed in water under standardized conditions of pressure and time. La pénétration d'eau en quantité nuisible à l'intérieur de l'enveloppe immergée dans l'eau, sous une pression et pendant une durée déterminée, ne doit pas être possible.
8 	Protegido contra la inmersión prolongada. Protection from the effects of prolonged immersion. Protégé contre les effets de l'immersion prolongée dans des conditions spécifiées.	El equipo o aparato adecuado para la inmersión prolongada en el agua. Appropriate equipment or apparatus for prolonged immersion in water in the terms specified by the manufacturer. Le matériel convient pour l'immersion prolongée dans l'eau dans des conditions spécifiées par le constructeur.

6.2

Kits de emergencia y datos tecnicos
Emergency kit and technical data
Éclairage de secours et données techniques

3.- Clasificación en función del grado de protección contra impactos

Classification according to the degree of protection against impacts

Classification en fonction du degré de protection contre les chocs mécaniques

ES

La presente clasificación utiliza un sistema de codificación para indicar el grado de protección proporcionado por una envolvente contra los impactos mecánicos nocivos.

Se identifica mediante las siglas IK seguidas de una cifra de dos dígitos, representativa de la resistencia a una determinada energía de impacto que una envolvente puede soportar sin sufrir deformaciones peligrosas.

El significado de los valores numéricos asignados a las cifras se indica en la siguiente tabla.

El grado de protección que garantiza el código IK se aplica a la envolvente en su totalidad. Si alguna parte de la misma tiene grado de protección diferente, debe indicarse por separado.

EN

This classification uses a coding system to indicate the degree of protection offered by the enclosure against mechanical impact damage.

It is represented with the IK_abbreviation followed by a two-digit numeral, which indicates the aptitude of an enclosure to withstand a determined impact energy without suffering harmful damage.

The meaning of the numerical values assigned to the figures is explained in the following table.

The degree of protection afforded by the IK_code applies to the entire enclosure. If any part of the enclosure has a different degree of protection, this should be indicated separately.

FR

Cette classification utilise un système de codification pour indiquer le degré de protection fourni par l'enveloppe contre les chocs mécaniques nuisibles.

Il est identifié avec les sigles IK suivies d'un chiffre, qui représente la résistance à une énergie de choc particulière que l'enveloppe doit supporter sans avoir des déformations dangereuses.

Le signifié des valeurs numériques assignés aux chiffres est indiqué dans le tableau ci-dessous.

Le degré de protection garantie par le code IK est applicable a toute l'enveloppe. Si une partie de cette enveloppe a un degré différent, il doit être indiqué séparément.

Energía de impacto en julios / Impact energy in joules / Énergie de choc en joules

00	Ninguna protección / No protection / Aucune protection
01	Resistente a una energía de choque de 0,15 J / Resistant to an impact energy of 0,15 J / Résistant à une énergie de choc de 0,15 J
02	Resistente a una energía de choque de 0,20 J / Resistant to an impact energy of 0,20 J / Résistant à une énergie de choc de 0,20 J
03	Resistente a una energía de choque de 0,35 J / Resistant to an impact energy of 0,35 J / Résistant à une énergie de choc de 0,35 J
04	Resistente a una energía de choque de 0,50 J / Resistant to an impact energy of 0,50 J / Résistant à une énergie de choc de 0,50 J
05	Resistente a una energía de choque de 0,70 J / Resistant to an impact energy of 0,70 J / Résistant à une énergie de choc de 0,70 J
06	Resistente a una energía de choque de 1 J / Resistant to an impact energy of 1 J / Résistant à une énergie de choc de 1 J
07	Resistente a una energía de choque de 2 J / Resistant to an impact energy of 2 J / Résistant à une énergie de choc de 2 J
08	Resistente a una energía de choque de 5 J / Resistant to an impact energy of 5 J / Résistant à une énergie de choc de 5 J
09	Resistente a una energía de choque de 10 J / Resistant to an impact energy of 10 J / Résistant à une énergie de choc de 10 J
10	Resistente a una energía de choque de 20 J / Resistant to an impact energy of 20 J / Résistant à une énergie de choc de 20 J

6.2

Kits de emergencia y datos tecnicos
Emergency kit and technical data
Éclairage de secours et données techniques

4.- Clasificación en función del material de la superficie de apoyo para la que está prevista la luminaria
Classification according to the material of the supporting surface for which the light fitting is destined
Classification en fonction du degré de la matière de la surface d'appui

ES

Materiales clasificados VO: Un material clasificado VO lo será cuando no haya ninguna muestra que arda con combustión de llama más de 10 segundos después de cada aplicación del test de la llama.

Materiales clasificados V2: Un material clasificado V2 lo será cuando no haya ninguna muestra que arda con combustión de llama más de 30 segundos después de cada aplicación del test de la llama.

EN

VO rated materials: A material meets VO requirements when there is no specimen that burns with flaming combustion for more than 10 seconds after each application of the test flame.

V2 rated materials: A material meets V2 requirements when there is no specimen that burns with flaming combustion for more than 30 seconds after each application of the test flame.

FR

Matériels classifiés VO : Un matériel sera classifié VO lorsqu'il n'y aura pas aucun échantillon qui brûle avec une combustion de flamme plus de 10 secondes après chaque application du test de la flamme.

Matériels classifiés V2 : Un matériel sera classifié V2 lorsqu'il n'y aura pas aucun échantillon qui brûle avec une combustion de flamme plus de 30 secondes après chaque application du test de la flamme.

Clasificación / Classification / Classification	Símbolo / Symbol / Symbole
<p>Luminarias previstas para montaje directo solamente sobre las superficies incombustibles.</p> <p>Light fittings for direct installation only on fire-resistant surfaces.</p> <p>Luminaires prévues pour installation directe sur des surface incombustibles.</p>	<p>Ningún símbolo, pero es necesaria nota de advertencia</p> <p>No symbol, but it is necessary to mention this in the precautionary notes</p> <p>Aucun symbol, mais c'est nécessaire une remarque d'avertissement</p>
<p>Luminarias sin balastos o transformador incorporado, previstas para el montaje directo sobre superficies normalmente inflamables.</p> <p>Light fittings without ballasts or an incorporated transformer, destined for direct installation on normally inflammable surfaces.</p> <p>Luminaires sans ballasts ou transformateurs incorporés convenant au montage direct sur des surfaces normalement inflammables.</p>	<p>Ningún símbolo</p> <p>No symbol</p> <p>Aucun symbol</p>
<p>Luminarias con balastos o transformador incorporado, previstas para montaje directo sobre superficies normalmente inflamables.</p> <p>Light fittings with ballasts or an incorporated transformer, destined for direct installation on normally inflammable surfaces.</p> <p>Luminaires avec ballasts ou transformateurs incorporés convenant au montage direct sur des surfaces normalement inflammables.</p>	

Jefe de Ventas Nacionales

Enrique Bravo
618 933 385
e.bravo@airfal.com

<p>Galicia Pedro Castro 600 020 735 axelrepresentaciones@axelrepresentaciones.com</p>	<p>Madrid, Ciudad Real, Toledo, Avila, Segovia, Guadalajara, Cuenca Fernando Vilaplana 673 218 384 - f.vilaplana@cgac.es</p>
<p>Alicante, Murcia, Albacete Ernesto Contero Peigneux 609 693 411 comercial@econtero.com</p>	<p>Euskadi Mikel Gurtubai - 656 784 406 Oier Gurtubai - 652 773 599 r.gurtubai@gmail.com</p>
<p>Baleares Carlos Corbacho 629 345 959 comercial@rep-corbacho.com</p>	<p>Valencia, Castellón Alejandro Reig 607 730 983 alejandro.reig@yahoo.com</p>
<p>Navarra, La Rioja Jesus Valencia 609 870 808 jvalenciamuruzabal@gmail.com</p>	<p>León, Zamora, Palencia, Asturias, Valladolid Juan José Guayo Gómez 658 478 792 juanjogugo@hotmail.com</p>
<p>Cataluña Francisco J. Requena 607 557 064 fjrequena@fjrequena.com</p>	<p>Aragón Mari Luz Donaire 659 450 836 deg.mluz@estopi.com</p>
<p>Canarias Julio Pérez Falcón 696 942 226 jpf_esc@electrosoncanarias.e.telefonica.net</p>	<p>Extremadura, Salamanca Juan Campos 609 447 709 jcguaati@hotmail.com</p>
<p>Granada, Jaén Jesús Civantos 629 587 274 civantosrepresentaciones@yahoo.es</p>	<p>Córdoba Carlos Rodriguez de los LLanos 670 907 121 carlos@global-set.net</p>
<p>Málaga, Almeria José Vilches Urea - 639 291 371 David Vilches Urea - 650 454 341 pepe@ejd-vilches.es</p>	<p>Sevilla, Cadiz, Huelva Jose Manuel Garcia-Rayó Laynez 650 930 083 rayolayne@rayolayne.com</p>
<p>Santander Orlando de Diego Polo 658 326 911 matelec@matelec.es</p>	

AIRFAL INTERNATIONAL

Río Esera 4 | 50830 Villanueva de Gállego, Zaragoza

Tel.: 976 185 809 | Fax: 976 186 086

www.airfal.com

e-mail: clientes@airfal.com

CONDICIONES GENERALES DE VENTA Y GARANTIA

- 1º Las condiciones de venta son para mercancía puesta en nuestra fábrica en Zaragoza, por consiguiente, los riesgos de transporte son por cuenta del comprador.
- 2º Para pedidos superiores a 600 € netos los portes serán a nuestro cargo, excepto en Bases y Esferas que viajarán siempre a portes debidos. Para los pedidos fuera de la Península, para que las mercancías viajen a portes pagados serán de una cuantía superior a 750 €.
- 3º El pedido mínimo será de 50 €. En caso de no alcanzar dicha cantidad se cobrarán 20 € por gastos de gestión.
- 4º Tubos protectores siempre cantidades según embalaje.

5º Reclamaciones:

- a) Como consecuencia del transporte: Se aceptarán en un plazo máximo de las 24 horas siguientes a la recepción de la mercancía, acompañando fotocopia del albarán de la Agencia de Transporte en el que constará la incidencia de rotura, mal estado, etc...
- b) Como consecuencia de faltas numéricas: Se aceptarán en un plazo máximo de las 24 horas siguientes al día de recepción.

6º Devoluciones:

Pasados 15 días de la recepción de una mercancía, el cliente no podrá realizar ninguna clase de reclamación ni devolución de las mismas.

No se aceptan devoluciones de material, salvo previo acuerdo y autorización por nuestra parte, efectuadas por escrito.

Los aparatos devueltos sólo se abonarán, como máximo, con el 80% de su valor en factura. Los portes de la devolución correrán por parte del cliente.

7º Este catálogo anula a todos los anteriores.

La información publicada en este catálogo ha sido cuidadosamente recopilada y es suficientemente precisa para la gran mayoría de las aplicaciones. Sin embargo, debido al continuo desarrollo y mejora en nuestros productos, pueden introducirse modificaciones en el material, diseño, especificaciones técnicas y homologaciones sin previo aviso.

Por todo ello, los esquemas deben ser tomados únicamente como referencia y recomendamos confirmar dimensiones antes de realizar el pedido.

8º AIRFAL INTERNATIONAL garantiza que sus luminarias están libres de defectos de fabricación desde la fecha de fabricación, durante un periodo de dos años.

Esta garantía está condicionada al apropiado almacenamiento, instalación y mantenimiento del producto. Esta garantía no es aplicable a cualquier producto que no haya sido instalado de acuerdo con la Reglamentación Eléctrica aplicable, los Estándares de Seguridad de AENOR, los estándares definidos por la ISO, y cualquier otra legislación local aplicable. Esta garantía no cubre los daños en cualquier luminaria debidos al abuso, mal uso, esfuerzos excesivos o fuera de lo normal y condiciones de operación para los que no está diseñada cada luminaria, así como contra sobre tensiones o instalación no adecuada. Todas las luminarias deben probarse antes de su instalación definitiva.

Esta garantía solo es aplicable al comprador original o en su caso al primer usuario final. Si un producto cubierto por esta garantía presenta cualquier defecto de fabricación, deberá ponerse en contacto con nuestro departamento de Calidad / Soporte Técnico para seguir el procedimiento que marca nuestro Servicio de Garantía. El Departamento de Calidad indicará al cliente los pasos a seguir.

Para propósitos de aclaración, "La reparación o reemplazo del producto presuntamente defectuoso" NO incluye costes de desinstalación o reinstalación del producto, o cualquier otro gasto relacionado que sea originado como consecuencia de no seguir las directrices marcadas por la Directiva Europea 99/44/EC (*). Si AIRFAL INTERNATIONAL decidiera reemplazar un producto defectuoso y ello no fuera posible por estar descatalogado o no disponible, los podría reemplazar por otro de similares características.

Esta garantía y las condiciones establecidas en ella es exclusiva y anula a cualquier otra, expresa o implícita, incluyendo aquellas derivadas de cualquier propósito particular o resultantes de negociaciones. La responsabilidad de AIRFAL INTERNATIONAL es exclusiva ante el comprador y conforme a lo establecido en el presente documento.

LIMITACIÓN DE RESPONSABILIDAD: AIRFAL INTERNATIONAL bajo ninguna circunstancia, ya sea como resultado de incumplimiento de contrato, incumplimiento de garantía, agravio, responsabilidad estricta o cualquier otra será responsable por daños indirectos, incidentales, o especiales, incluyendo pero sin limitarse a, la pérdida de ingresos o beneficios, pérdida de uso del producto o de cualquier otro bien o equipo o daño a cualquier equipo asociado, costo de capital, costo de productos sustitutos, las instalaciones de los servicios, o reclamaciones de los clientes del comprador. La responsabilidad de AIRFAL INTERNATIONAL de ninguna manera cubrirá los daños surgidos de un posible defecto de fabricación por un valor superior al de la mercancía adquirida.

(*) La instalación de las luminarias debe tener en cuenta la facilidad de reemplazo a fin de limitar el costo del mismo. Una luminaria instalada profesionalmente se considera que debe ser reemplazable en 10 minutos. Si el fácil reemplazo no está planificado, el usuario final debe ser informado de que el futuro mantenimiento normal puede incurrir en costos adicionales. En la instalación de las luminarias, hay que tener en cuenta que se puede necesitar el reemplazo de lámparas y componentes antes del final de la vida útil de las mismas.

For export general sales conditions: export@airfal.com

